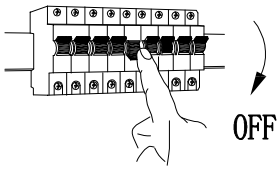
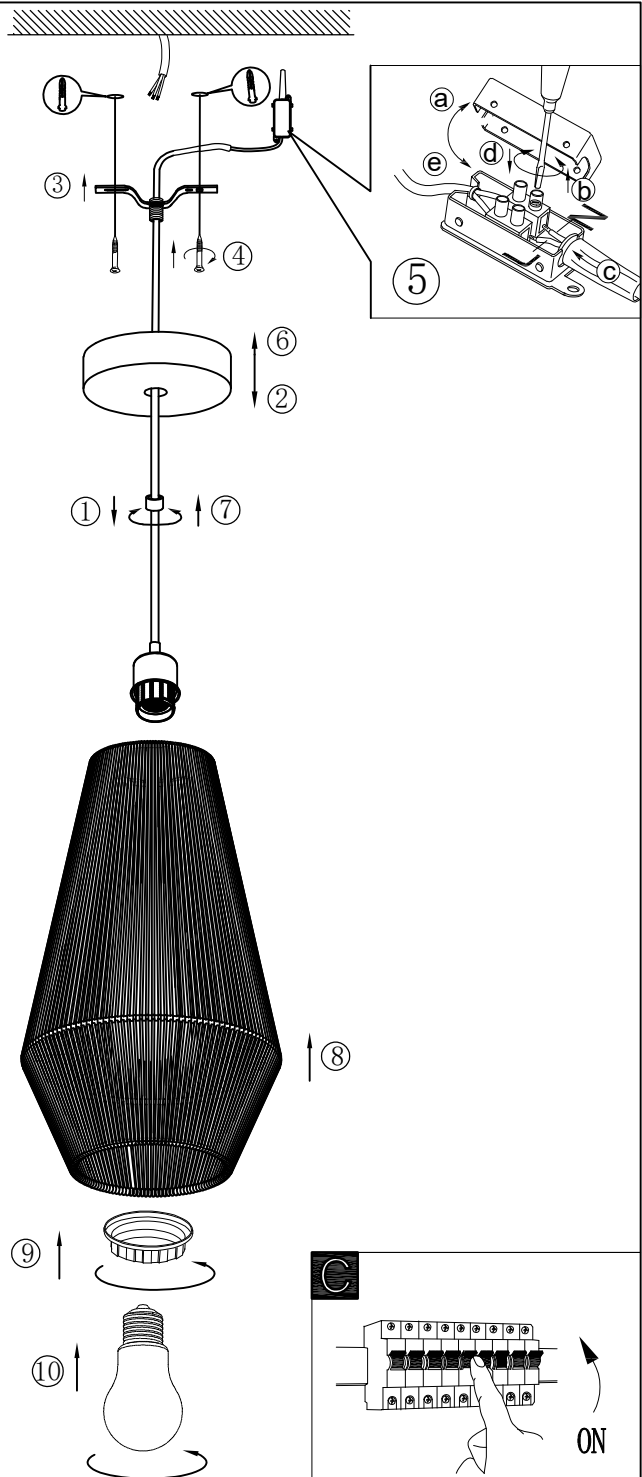
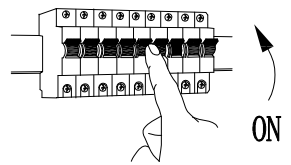

**A****B****C**

B43785  
www.eglo.com