

# Bedienungsanleitung

Android UHD 4K TV Box

Receiver / IPTV/ OTT Mediaplayer



OCTAGON SPIRIT V2 4K



[www.octagon-germany.eu](http://www.octagon-germany.eu)

## Installationsanleitung

1, Verbinden Sie Ihre Box mit einem HDMI-Kabel mit Ihrem Fernseher.

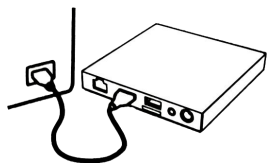

2, Schließen Sie Ihre Box über das Netzkabel an die Stromversorgung an.

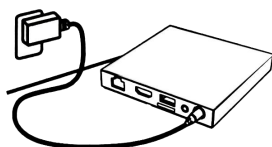

3, Schalten Sie Ihren Fernseher ein und wechseln Sie zum richtigen HDMI-Eingang.

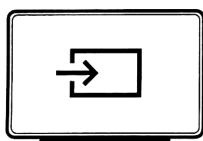

4, Richten Sie Ihre Box ein und verbinden Sie sie mit Ihrem lokalen Netzwerk.

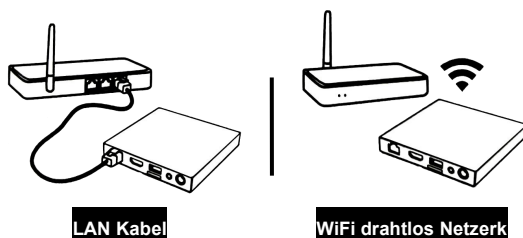

5, Bitte richten Sie Ihre Box ein, um das wunderbare Erlebnis zu genießen.



## Was ist in der Box? (Lieferumfang)



Octagon Receiver



Fernbedienung

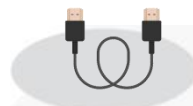

HDMI Kabel



Netzteil



IR Empfänger



2X Batterien

# SICHERHEITSHINWEISE!

Dieses Gerät wurde unter Einhaltung internationaler Sicherheitsstandards gefertigt. Lesen Sie die folgenden Sicherheitshinweise sorgfältig durch..

Vielen Dank, dass Sie sich für diesen Receiver entschieden haben! Zu Ihrer Sicherheit und damit Ihr Receiver zuverlässig funktioniert, nehmen Sie sich bitte die Zeit, diese Anleitung aufmerksam zu lesen, bevor Sie das Gerät anschließen und einschalten. Diese Anleitung soll Ihnen helfen, die zahlreichen Funktionen optimal zu nutzen.

Nehmen Sie den Gehäusedeckel nicht ab. Andernfalls besteht die Gefahr eines elektrischen Schlags. Reparaturen an Stecker, Kabel oder Receiver dürfen nur von qualifiziertem Fachpersonal durchgeführt werden..

## Schutzmaß nahmen (Wichtige Sicherheitshinweise):

- Das Gerät ist nur für Netzanschluss 100- 250 V AC / 50 Hz vorgesehen.
- Ziehen Sie den Netzstecker aus der Steckdose, bevor Sie Wartungs- oder Installationsarbeiten beginnen.

### - Anschluss an das TV-Gerät

- Ziehen Sie den Netzstecker aus der Steckdose.

### - Feuchtigkeit

- Der Empfänger darf keinerlei Flüssigkeiten ausgesetzt sein!

### - Reinigung

- Ziehen Sie den Netzstecker aus der Steckdose.
- Verwenden ein leicht angefeuchtetes Tuch, um eventuell anhaftenden Staub zu binden.

### - Belüftung

- Die Kühlschlitze im Gehäusedeckel dürfen keinesfalls abgedeckt werden, um eine sichere Ableitung der im Gerät entstehenden Wärme zu gewährleisten..

### - Fremdobjekte

- Stecken Sie niemals irgendwelche fremden Metallgegenstände in die Einschübe oder Lüftungsschlitze des Gerätes.

### - Gewitter

- Bei Gewitter oder Betriebsstörungen Stecker ziehen.

### - Reparatur & Wartung

- Reparatur und Wartungsarbeiten dürfen nur von qualifizierten Fachkräften durchgeführt werden. Da bei diesem Gerät die Trennung vom Stromnetz durch das Ziehen des Steckernetzteils erfolgt, ist es unbedingt notwendig, dass dieses jederzeit leicht zugänglich ist.

Bitte beachten Sie, dass vor jeglichen Wartungs- oder Installationsmaßnahmen die Stromversorgung unterbrochen werden muss.

Achten Sie darauf, dass das Stromkabel so platziert wird, dass es bei einem Notfall schnell von der Stromversorgung getrennt werden kann.

**- FRONTBLENDE (VORDERSEITE):**



- **LED status Anzeige**

Zeigt Betrieb oder Standby am (grün/ rot)

- **Infrarot Empfänger**

IR Sensor befindet sich auf der rechten Seite.

**- GERÄTE RÜCKSEITE & SEITLICH:**



- **USB 3.0**

USB 3.0 Anschluß

- **TF Card**
- **AV - Audio & Video**

Composite AV Buchse mit Klinkenstecker.

- **SPDIF AUDIO**

Digitaler Audio Ausgang.

- **HD OUT &HDMI**

HD OUT - HDMI Ausgang zum TV-Gerät.

- **LAN&ETHERNET**

LAN Port RJ45 - Internet Anschluß.

- **DC IN-12V**

Stromanschluss 12 Volts DC, A



- **USB 2.0**

USB 2.0 Anschluß























- **IR Anschluß**

Externer IR Sensor – Infrarotempfänger Port

- **RCOVERY**

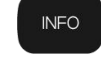
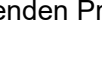
RESET Taste für Service.

# FERNBEDIENUNG

-  POWER STB: Receiver Ein- / Ausschalten
-  Quelle Gerät (source) wählen
-  Gruppen öffnen (aufrufen)
-  Serien öffnen (aufrufen)
-  VOD öffnen (aufrufen)
-  Radio öffnen (aufrufen)
-  YouTube öffnen (starten)
-  Favoriten öffnen oder hinzufügen
-  Stop Taste
-  Play (Wiedergabe) und Pause
-  Mute: Ton Ein- / Ausschalten
-  Gehe zum vorherigen Menü (Exit)
-  Hauptmenü öffnen
-  EPG: Elektronischer Programmführer
-  Öffne LIVE TV
-  Zurück HOME MENU
-  Rot, Grün, Gelb und Blau (programmierbar)
-  Zahlentasten: Direkte Eingabe von Sendernummern und Zahlen
-  INFO: Informationsfenster des laufenden Programms
-  Lautstärke einstellen
-  Sender auf/ab schalten
-  Menübewegung und -steuerung
-  per Sprache suchen
-  Im Menü auswählen
-  programmierbare Taste



## Spezifikationen

Chipsatz	Amlogic S905X3
CPU-Kerne	Quad-core
CPU-Architektur	ARM Cortex A55
GPU	ARM Mali-450
Arbeitsspeicher	2GB DDR3
Flashspeicher	32GB
Bluetooth	5.1
HDMI	HDMI2.0a TX, 4K 10bit UHD@60Hz up4096x2160px 1080p/i, 720p/i, 576p/i, 480p/i
Netzwerk	RJ45 10/100M Ethernet Interface
Wi-Fi	DualBand 2.4/5GHz 802.11a/b/g/n/ac MIMO 2 built-in antennas
USB	1xUSB 3.0, 1xUSB 2.0
Anschlüsse	AV, HDMI 2.0, USB 3.0, S/PDIF, LAN 10/100Mbit DC 12V
Software	Android 9.0
Audio-Unterstützung	Digital Sound 5.1, 7.1
Audio-Container	MP3, AAC, OGG, OGA, FLAC, ALAC, others via applications
Eingangsspannung	DC 12V/1A
Energieverbrauch	Max. 12W
Stromverbrauch im Standby	<0.5W
Lgertemperatur	-40~60C
Betriebstemperatur	-5~45C
Feuchtigkeit	<95%
Abmessungen	140*91*28
Netto-Gewicht	200g

Spezifikationen.....	5
Einrichtung.....	7
Launcher.....	11
Firmware manuell aktualisieren .....	12
Neue Firmware erinnern.....	15
Private App-Installation und -Upgrade.....	16
MeTV.....	17

## Einrichtung

Dies ist der erste Bildschirm, den Sie sehen, wenn Sie den Empfänger einschalten. Sie müssen die „OK“-Taste der Fernbedienung 6 Sekunden lang drücken, um in den Kopplungsmodus zu gelangen (die LED auf der Fernbedienung blinkt).

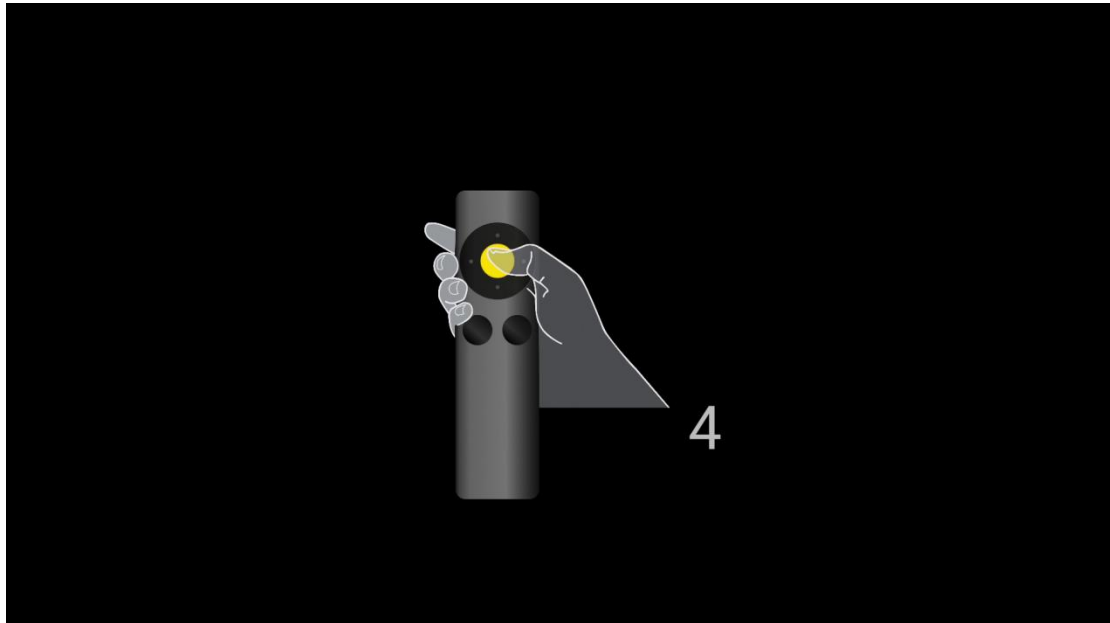

Wenn der Empfänger das Kopplungssignal der Fernbedienung empfangen hat, wird der Kopplungsbildschirm angezeigt.

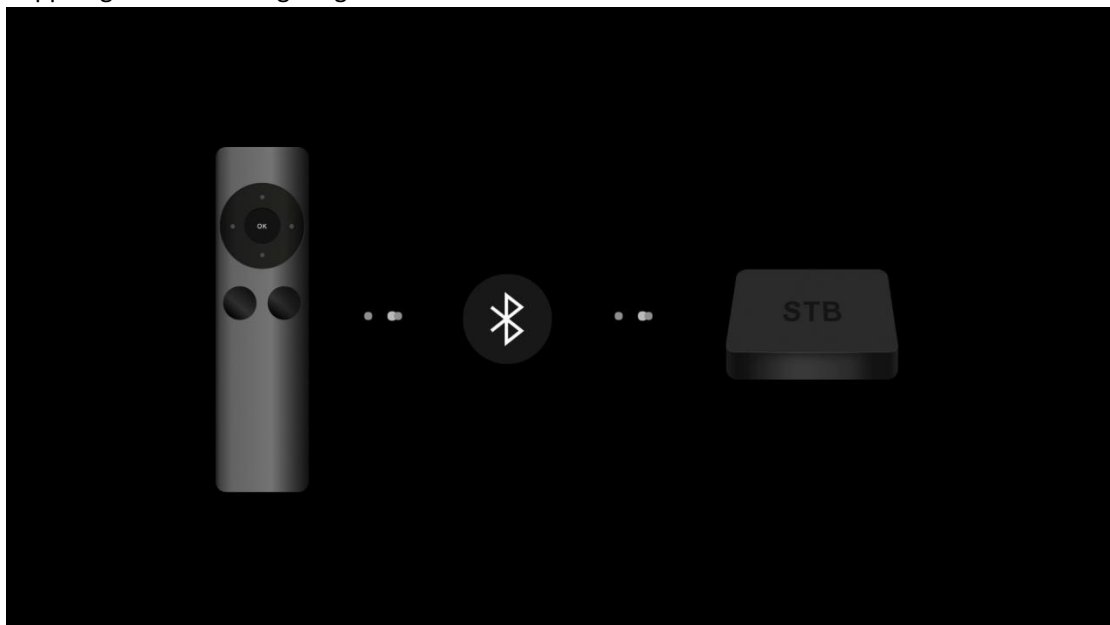

Nach erfolgreicher Kopplung wird das Sprachauswahlmenü angezeigt.



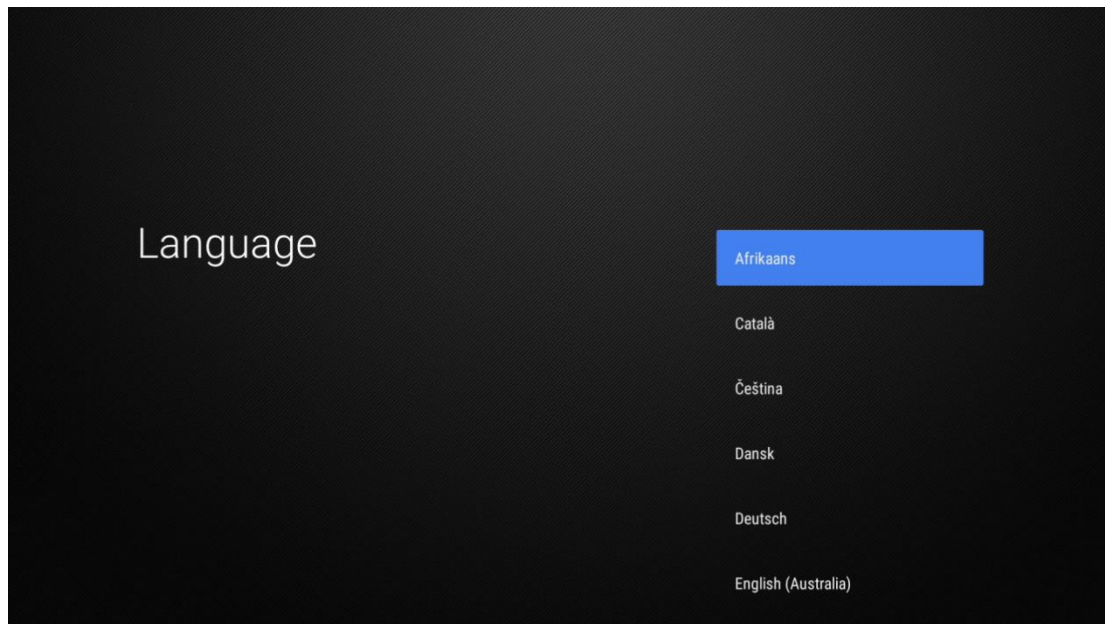

Einrichten der Internetverbindung über Ethernet.

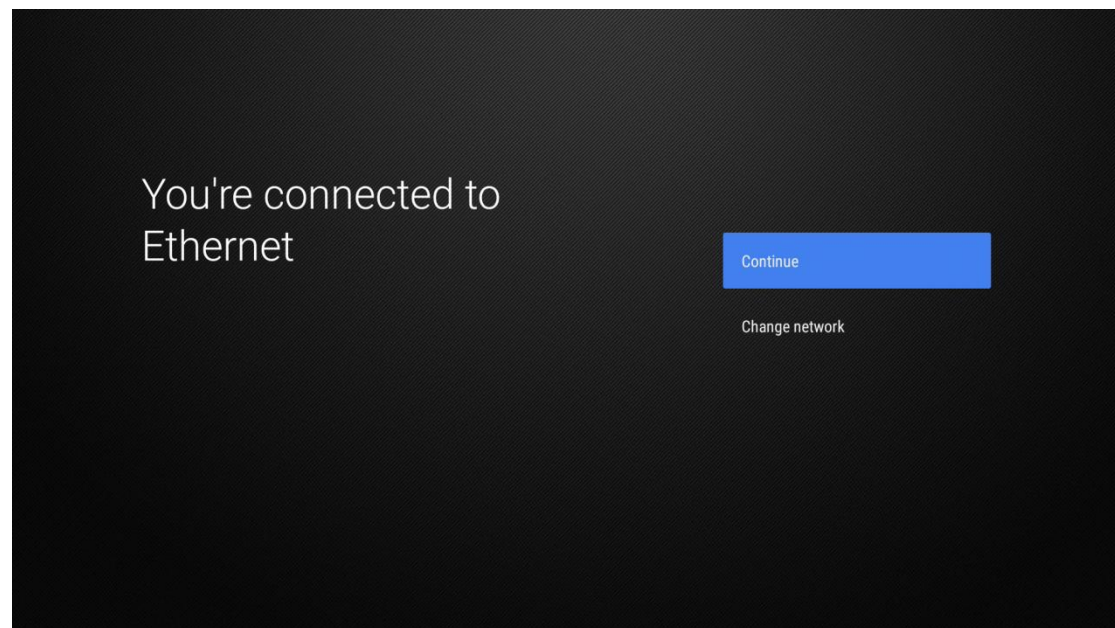

Oder wählen Sie „Netzwerk ändern“ für Wi-Fi.

Select your Wi-Fi network

- AK47
- AK47-5G
- ChinaNet-HEpY
- ChinaNet-HEpY-5G
- ChinaNet-niQy
- NG Family

Nachdem die Internetverbindung hergestellt wurde, installiert der Receiver die grundlegenden Anwendungen und die Standardkonfiguration.

Waiting for the smartupgrade to be ready





## App Installation

	<b>Netflix</b> 2.0.5 downloading 10 %
	<b>MeTV</b> 1.1.2 downloading 45 %
	<b>Me Weather</b> 1.0.1 downloading 68 %

# Hauptmenü (Launcher)

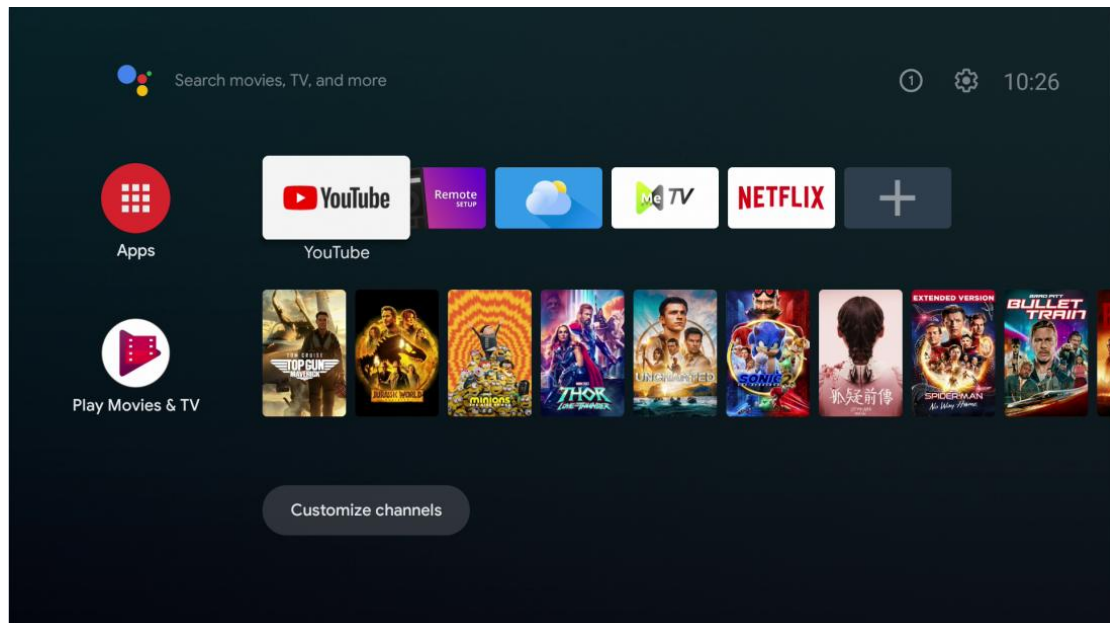

Durch langes Drücken der „OK“-Taste werden Ihnen weitere Funktionen angezeigt, z. B. Starten (öffnen) , Verschieben und Entferne aus den Favoriten.

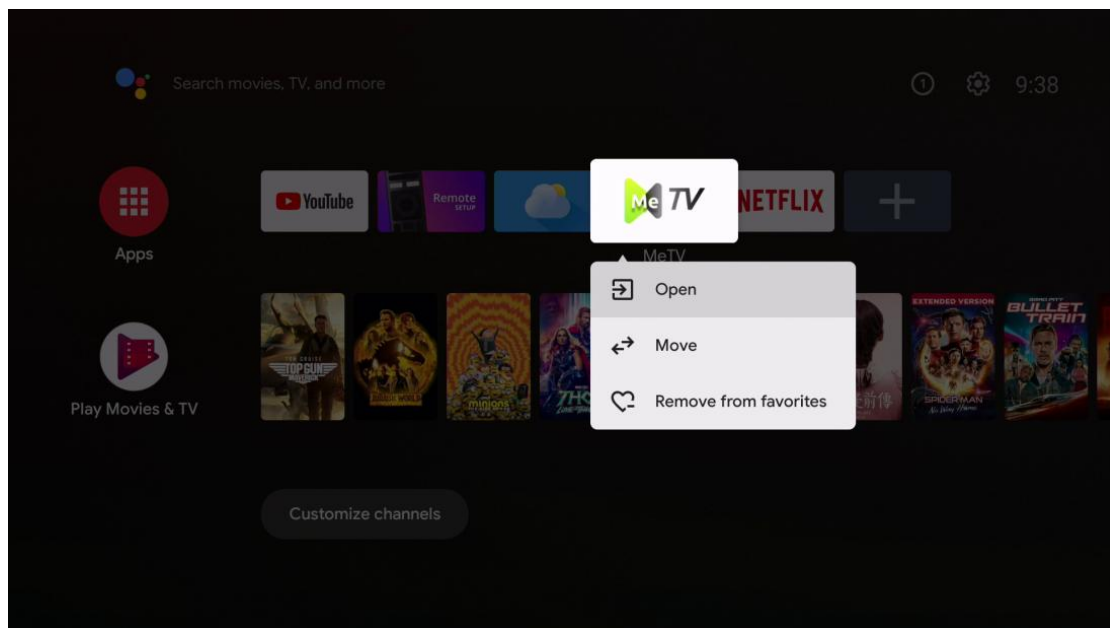

Drücken Sie das „+“-Symbol, Sie können dem Hauptmenü (Launcher) weitere Apps hinzufügen.



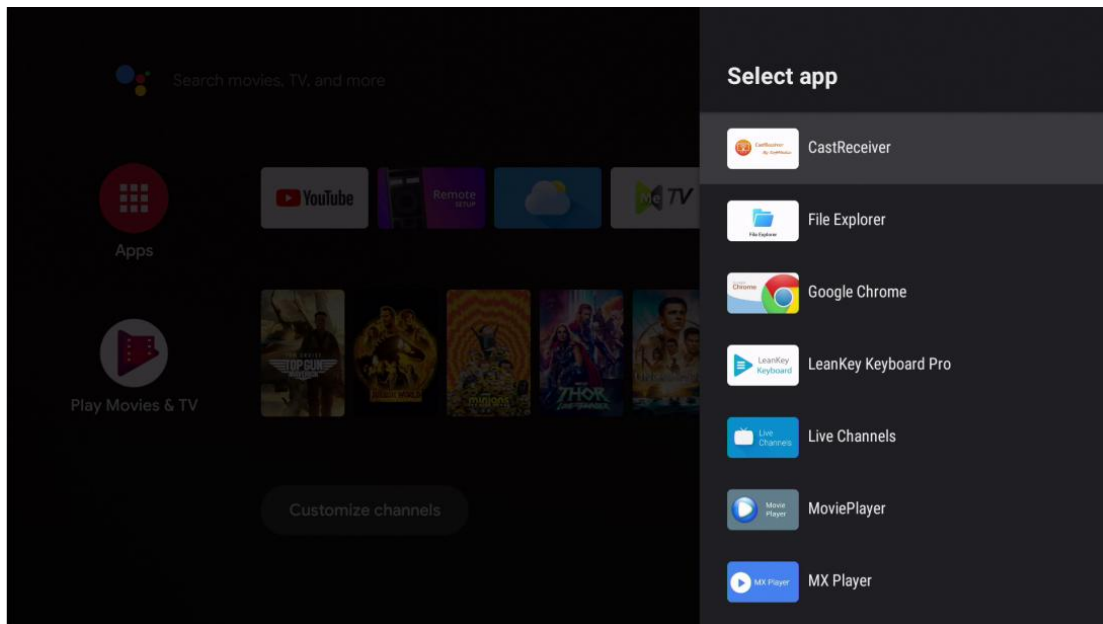

## Firmware manuell aktualisieren

Einstellungen > Erweiterte Einstellungen > Systemaktualisierung ein.

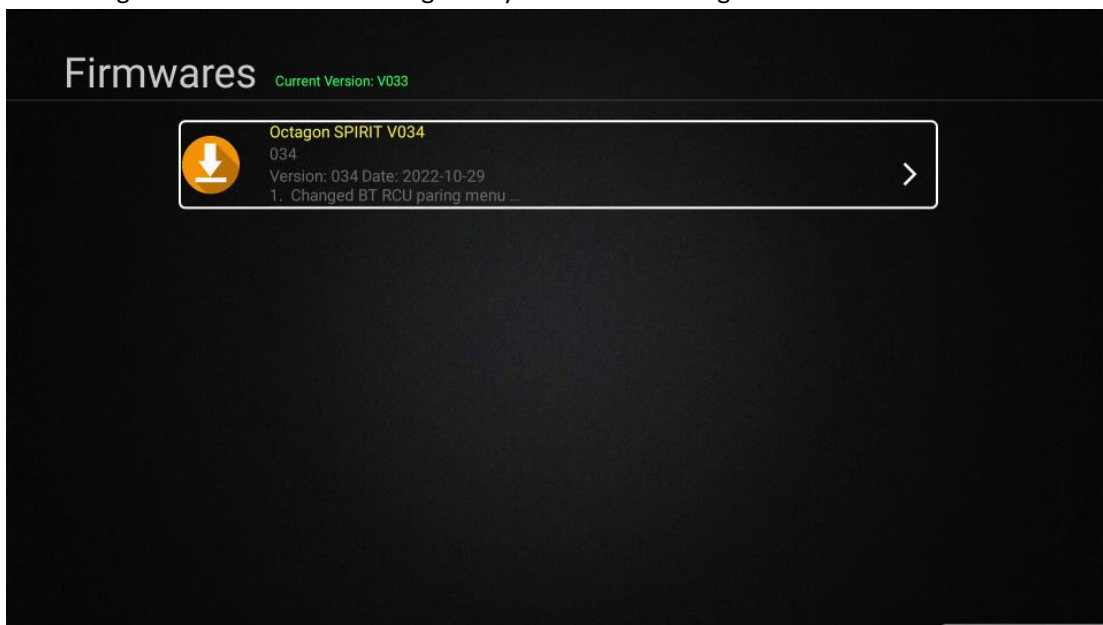

Wählen Sie eine Firmware aus und drücken Sie „OK“.

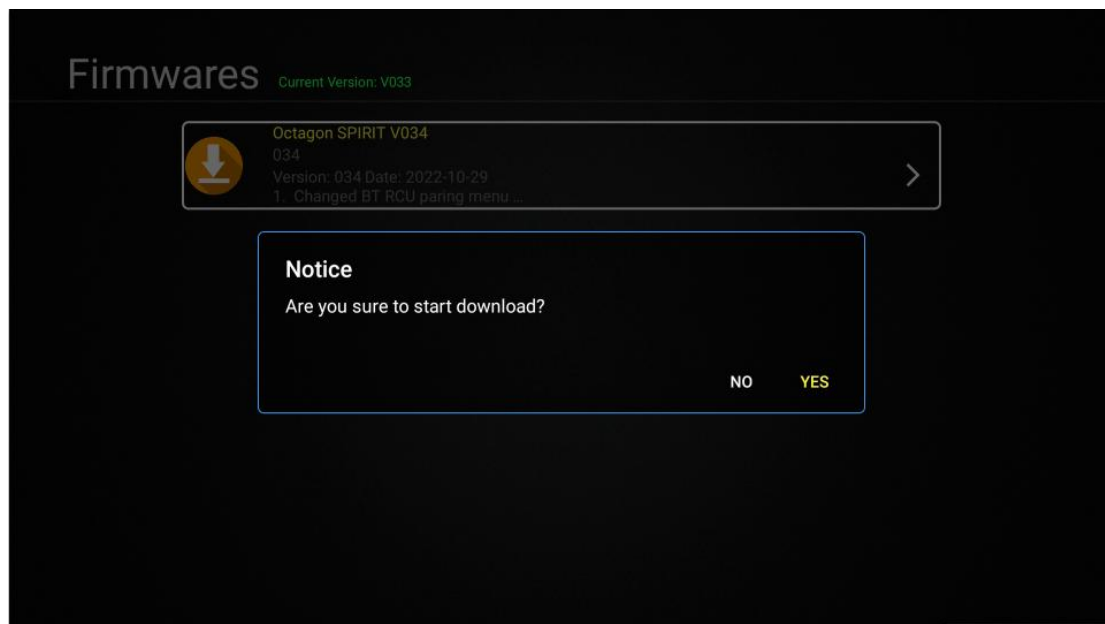

Wählen Sie „JA“, um den Download zu starten.

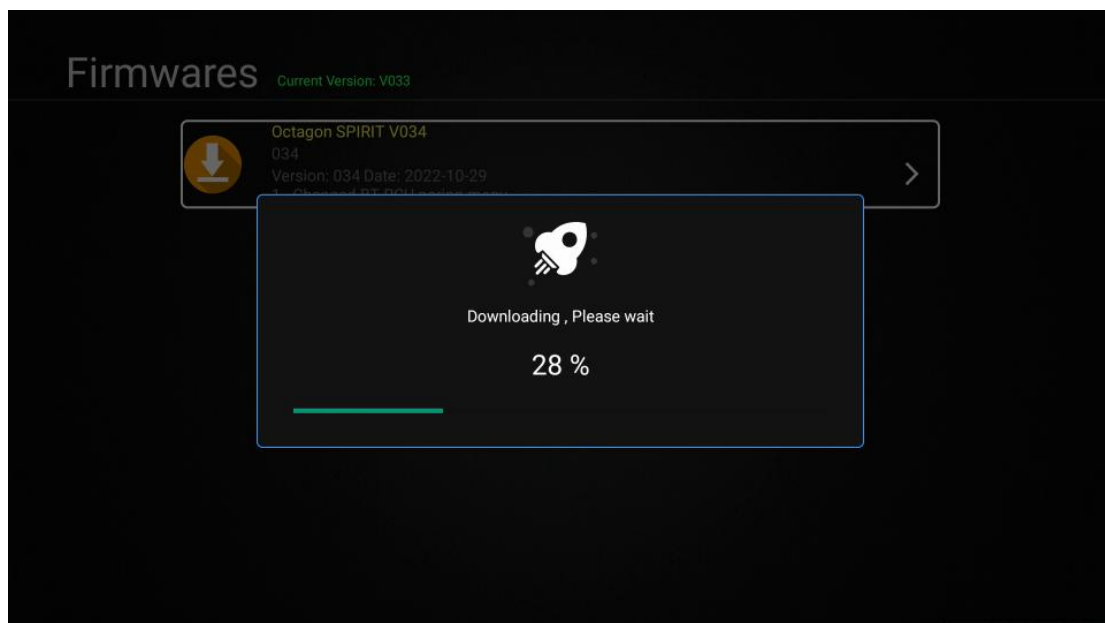

Nach Abschluss des Downloads werden Sie erneut aufgefordert, das Upgrade zu bestätigen.

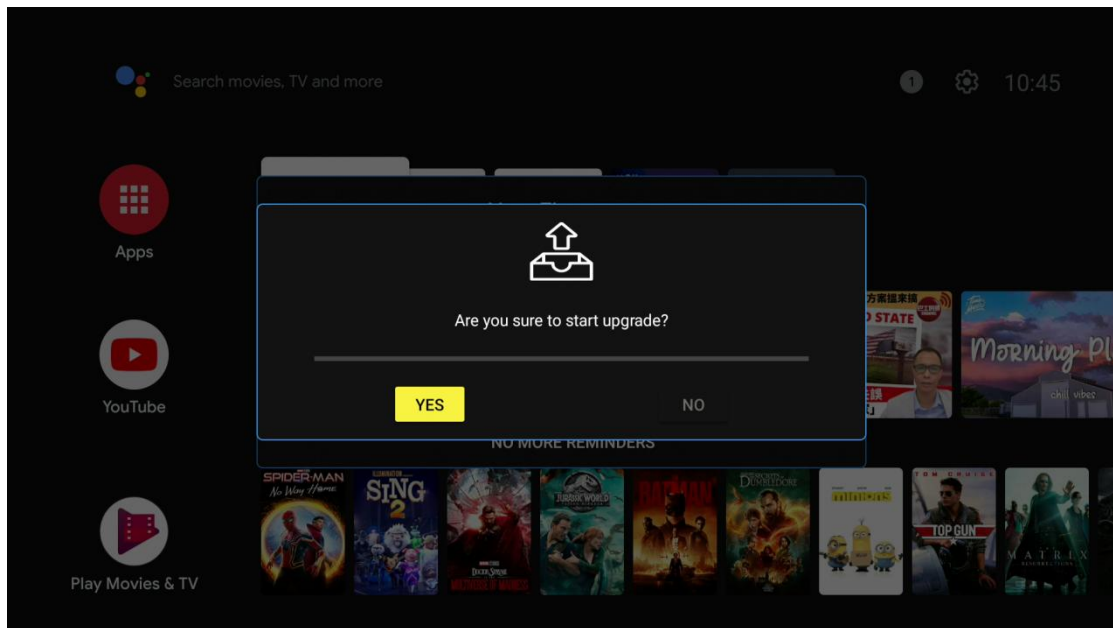

Wählen Sie „JA“, das Upgrade wird gestartet.

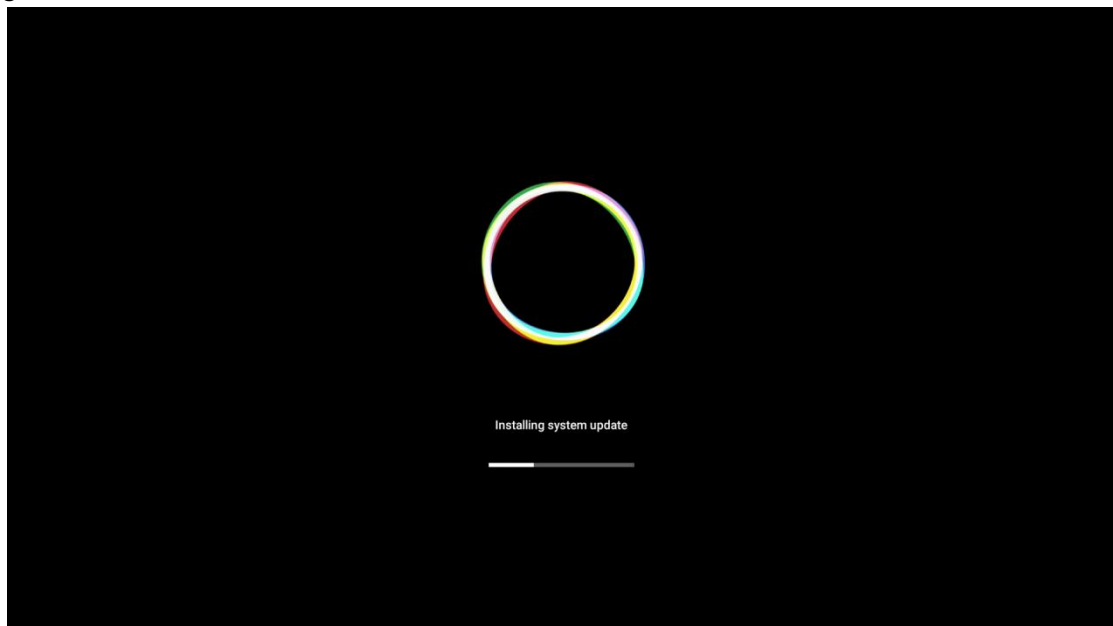

Wenn das Upgrade abgeschlossen ist, wird es automatisch neu gestartet.

## Neue Firmware erinnern

Wenn die neue Version der Firmware online ist, wird eine Meldung angezeigt.

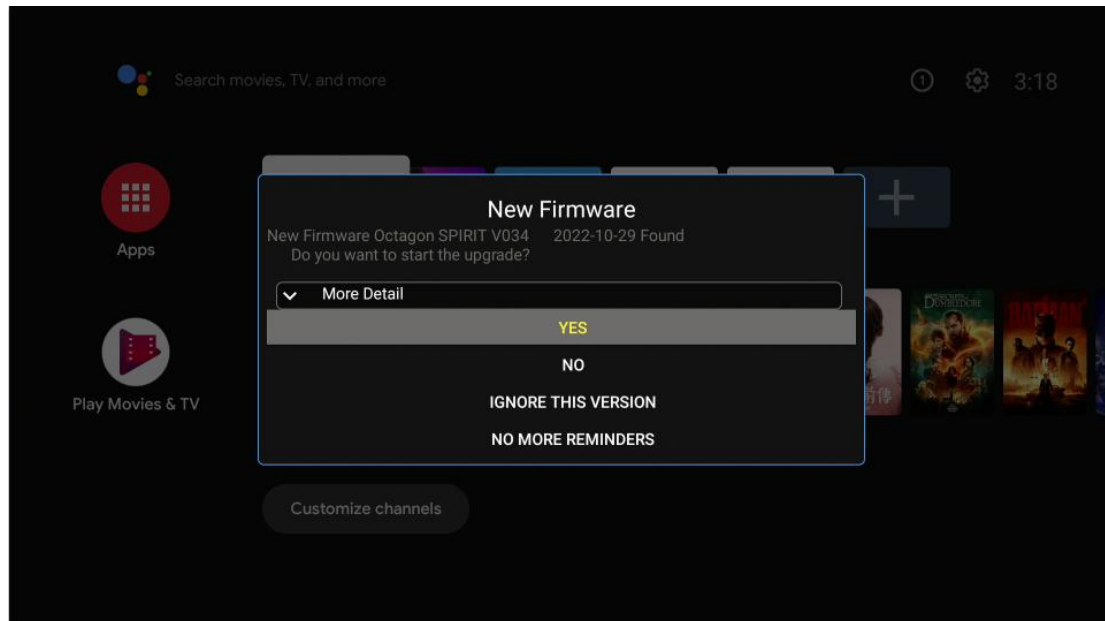

Wählen Sie „JA“, der Download und das Upgrade beginnen wie bei „Firmware manuell aktualisieren“.

## Private App-Installation und -Upgrade

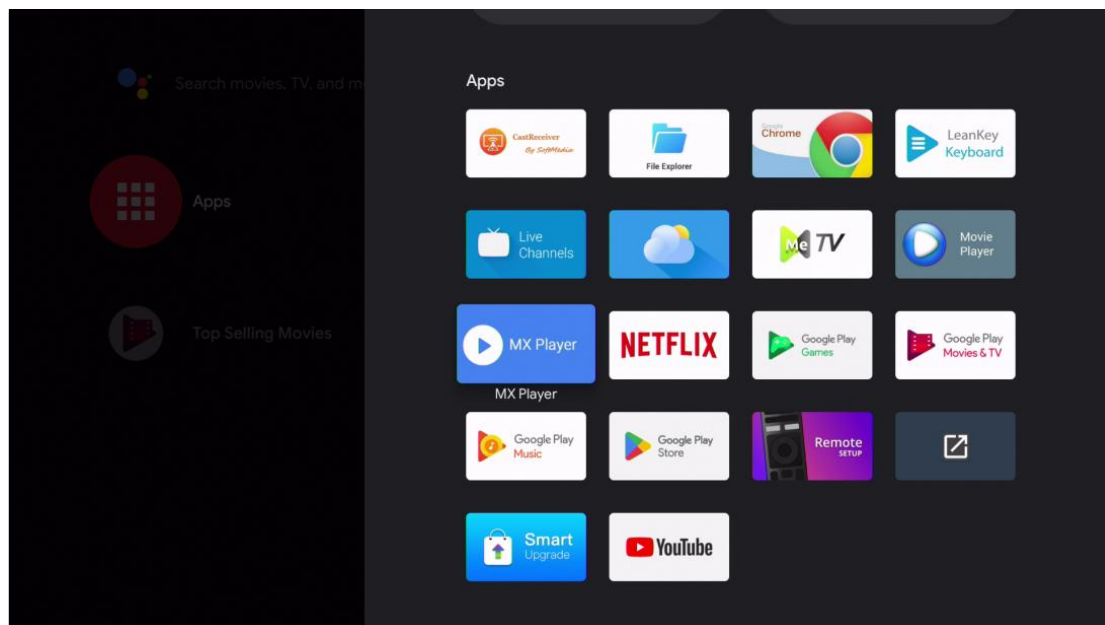

Öffnen Sie die App „Smart Upgrade“, es wird die private App-Liste angezeigt.



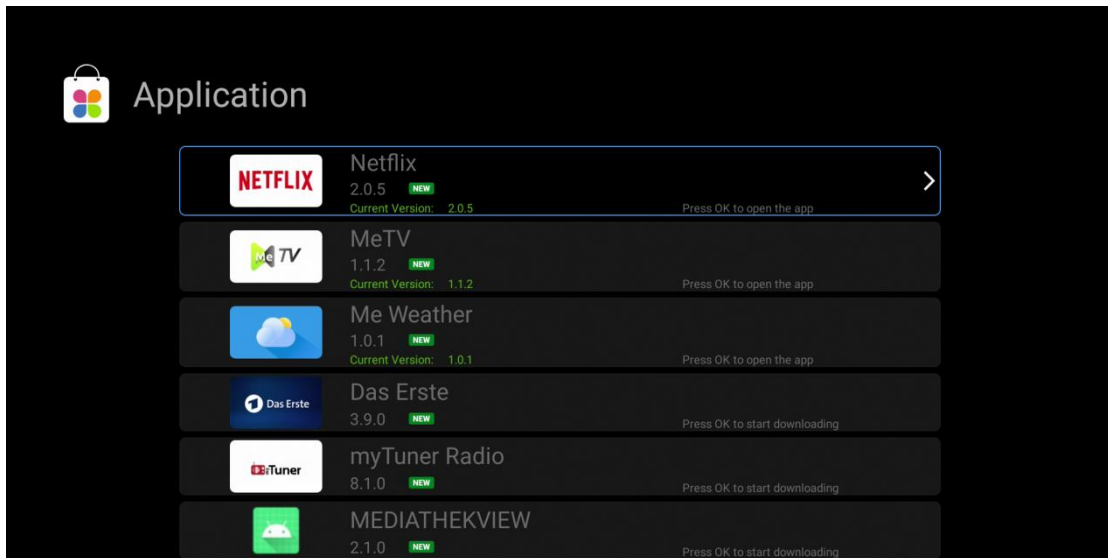

Drücken Sie die „RECHTS“-Taste, Sie können eine Version zum Upgrade oder Downgrade auswählen.

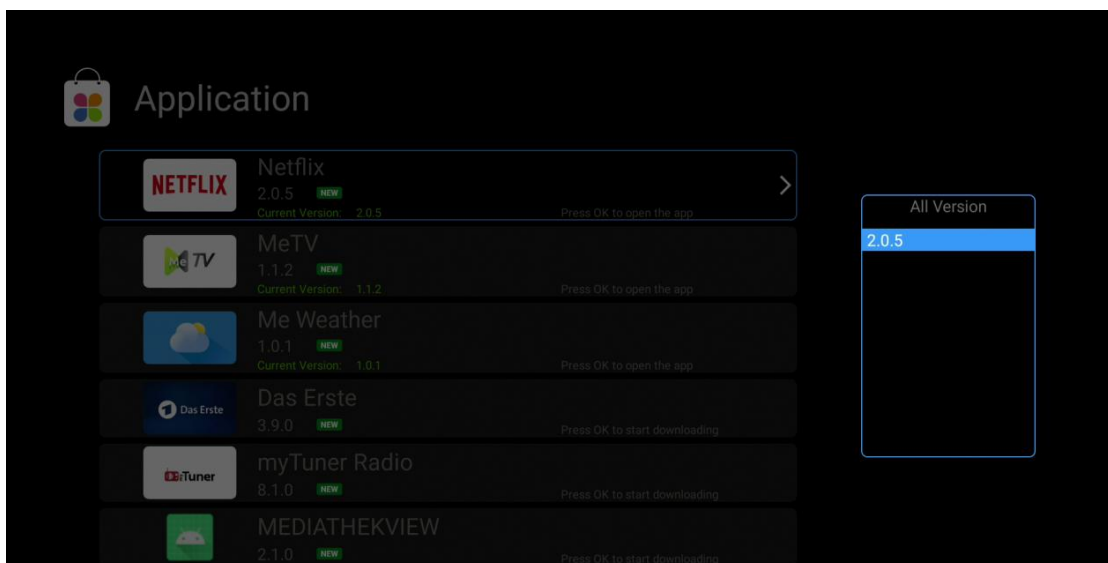

# MeTV

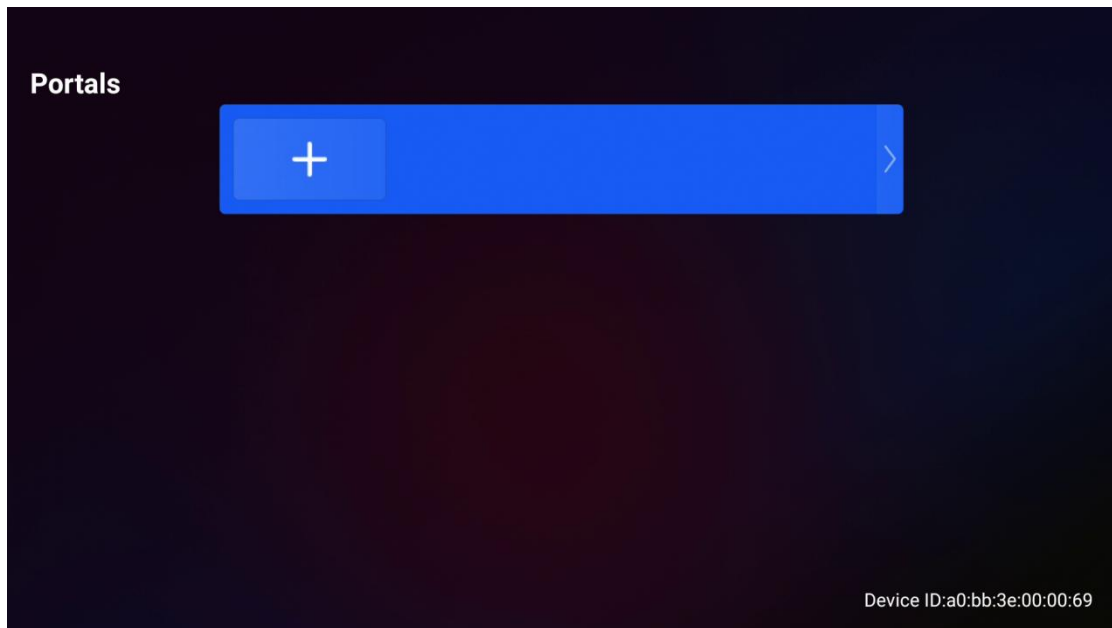

Drücken Sie die  
„RECHTS“-Taste.

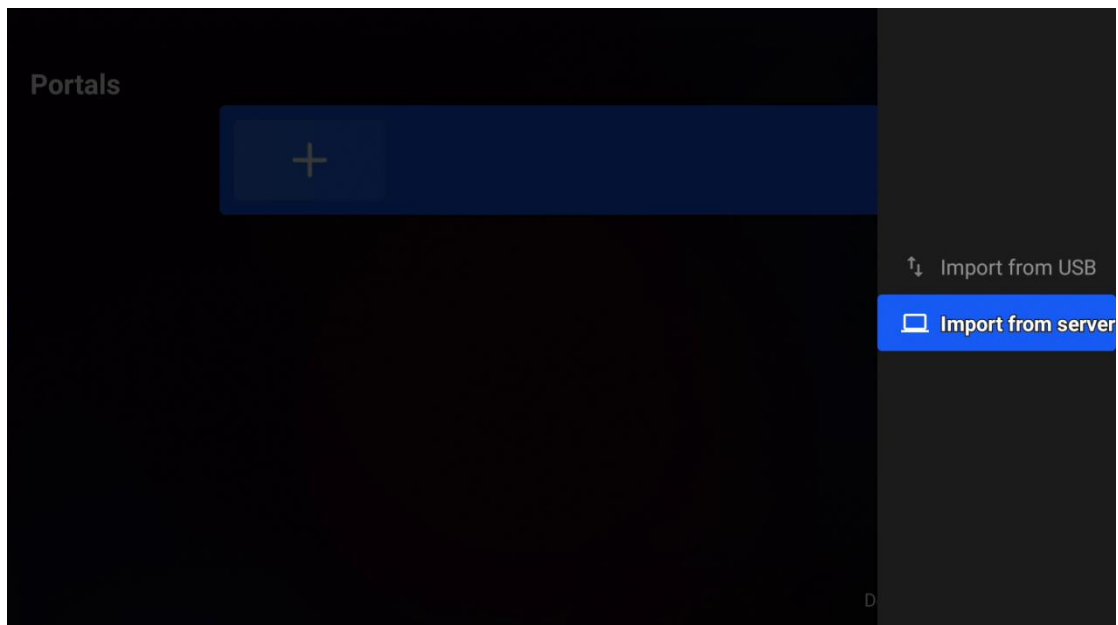

Wählen Sie „Von USB importieren“, um Portale von USB zu installieren.  
Wählen Sie „Vom Server importieren“, um Portale aus dem Internet zu installieren.

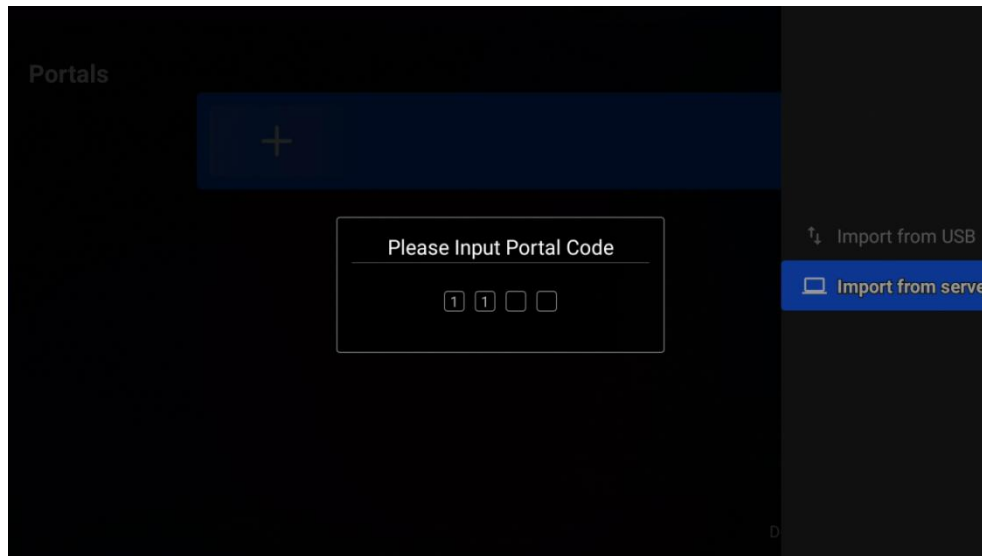

Geben Sie „Portalcode“ ein, um die Portale zu installieren.

Sie können das Portal auch manuell bearbeiten.

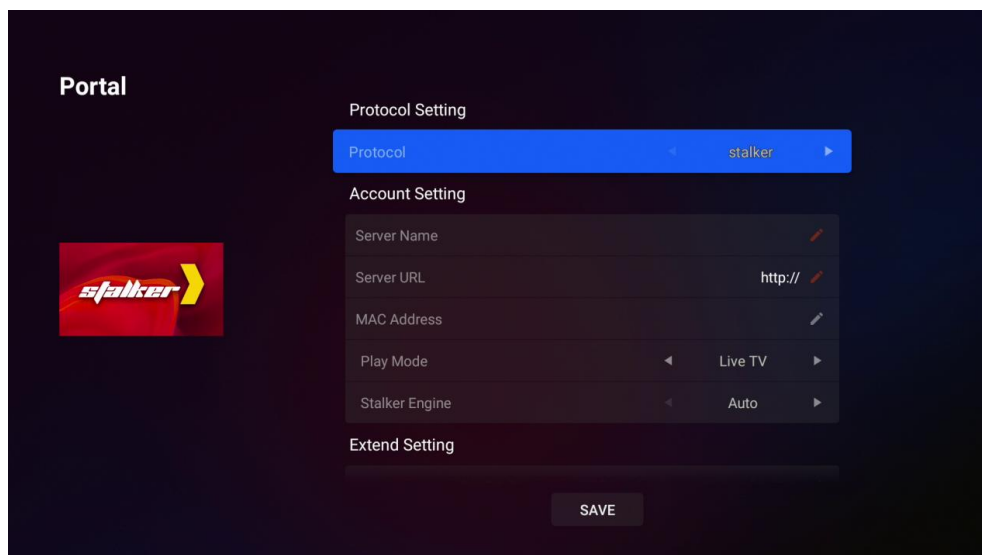

## WIFI Module:

Wlan Standard :IEEE 802.11b/g/n

Frequency Range:2.400GHz~2.497GHz(2.4GHz ISM Band)

Number of Channels:2.4GHz CH1~CH14

Modulation:802.11b DQPSK,DBPSK CCK

802.11g/n:OFDM/64QAM 16QAM QPSK BPSK

Output Power:802.11b/11Mbps:17±2dbm@EVM≤-15db

802.11g/54Mbps:15±2dbm@EVM≤-28db

802.11n/MCS7:14±2dbm@EVM≤-30db

RX sensitivity: 802.11b/11Mbps:-85dbm

802.11g/54Mbps:-72dbm

802.11 n HT20/MCS7:-70dbm

802.11n HT40/MCS7:-66dbm  
Wlan Standard :IEEE 802.11a/n/ac 2x2 Wifi compliant  
Frequency Range:4.900GHz~5.845GHz(5.0GHz ISM Band)  
Number of Channels:5.15 GHz ~5.25 GHz(36,40,44,48)  
5.25 GHz ~5.35 GHz(52,56,60,64)  
5.5GHz~5.7GHz(100,104,108,112,116,120,124,128,132,136,140)  
5.725 GHz ~5.825 GHz(149,153,157,161,165)  
Modulation:802.11a OFDM/64QAM,16QAM,QPSK BPSK  
802.11n:OFDM/64QAM 16QAM QPSK BPSK  
802.11ac:OFDM/256QAM  
Output Power:802.11a/54Mbps:15±2dbm@EVM≤-25db  
802.11n HT20/MCS7:14±2dbm@EVM≤-28db  
802.11n HT40/MCS7:14±2dbm@EVM≤-28db  
802.11ac VHT20/MCS8:13±2dbm@EVM≤-30db  
802.11ac VHT40/MCS9:13±2dbm@EVM≤-32db  
802.11ac VHT80/MCS9:13±2dbm@EVM≤-32db  
RX sensitivity: 802.11a/54Mbps:-72dbm  
802.11n HT20/MCS7:-69dbm  
802.11n HT40/MCS7:-67dbm  
802.11ac HT20/MCS8:-65dbm  
802.11ac HT40/MCS9:-60dbm  
802.11ac HT80/MCS9:-55dbm  
Maximum input level:802.11a/n/ac:-20dbm  
Maximum output level:802.11a/b/g/n/ac:20dbm

### **Service**

**OCTAGON Germany**

**Buendtenaecker 2**

**D-79730 Murg**

**Tel: 0049-(0)7763-704484**

**Fax: 0049-(0)7763-704483**

**E-Mail: [info@octagon-germany.de](mailto:info@octagon-germany.de)**

**Internet: [www.octagon-germany.de](http://www.octagon-germany.de)**

**Support: [www.octagon-forum.eu](http://www.octagon-forum.eu)**

**WEEE-Reg.-Nr. DE 69966297**

**[www.octagon-germany.eu](http://www.octagon-germany.eu)**

**[www.octagon-forum.eu](http://www.octagon-forum.eu)**

# User manual

Android UHD 4K TV Box  
Receiver / IPTV/ OTT Mediaplayer



android 

**OCTAGON SPIRIT V2 4K**



[www.octagon-germany.eu](http://www.octagon-germany.eu)

## Installation Guide

1,Connect your box to your TV with an HDMI cable

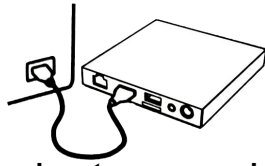

2,Connect your box to power using the power cord

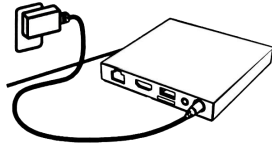

3,Turn on your TV and switch to the correct HDMI input

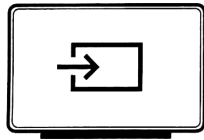

4,Set-up your box and connect to your local network

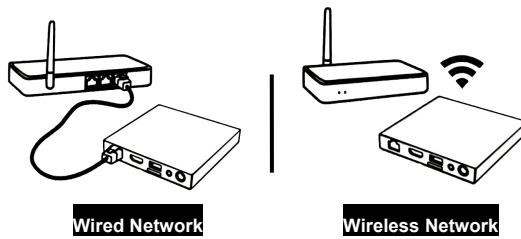

5,Please set up your box to enjoy the wonderful experience



## What's in the Box?



Media Receiver



Remote Control

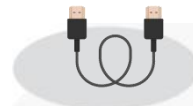

HDMI Cable



Power Adapter



IR Sensor



2X Batteries

## CAUTION!

To avoid the risk of electric shock, do not disassemble the receiver.

There are no user-serviceable parts inside.

Refer servicing to qualified service personnel.

This receiver was manufactured in accordance with international safety standards.

Please read the following precautions carefully.

### **Safety Instructions and Precautions:**

Products are designed to operate safely when installed and used according to the product instructions and safety practices. The guidelines included in this document explain the potential risks associated with equipment operation and provide important safety practices designed to minimize these risks, by carefully following the information contained in this document, you can protect yourself from hazards and create a safer environment.

This product is designed and tested to meet IEC62368-1, the standard for safety of information technology equipment. This also covers the implementation of IEC62368-1 based safety standards around the world.

Retain and follow all product safety and operating instructions. Always refer to the documentation supplied with your equipment. Observe all warnings on the product and in the operating instructions.

Note: read all safety information below and operating instructions before using box to avoid injury.

Warning: failure to follow these safety instructions could result in fire, electric shock or other injury or damage. Electrical equipment can be hazardous if misused. Operation of this product, or similar products, must always be supervised by an adult. Do not allow children access to the interior of any electrical product and do not permit them to handle and cables.

#### **- Power supply network connection (100-240V ~ 50/60Hz)**

- Connect this receiver only to the type of network indicated on the label
- Unplug the receiver from the electrical outlet before beginning any maintenance or installation

#### **- Connecting to antenna**

- Disconnect the receiver from the network before connecting or disconnecting the cable from the antenna
- Failure to do so may result in damage to the receiver or antenna

#### **- Connecting to a TV**

- Unplug the receiver from the electrical outlet before connecting or disconnecting the cable from the TV

Failure to comply may result in damage to the receiver or TV

#### **- Liquids**

- The receiver must not be exposed to liquids of **ANY** kind!

**- Cleaning**

- Unplug the receiver from the electrical outlet before cleaning
- To remove dust, use a light damp cloth, without solvents

**- Ventilation**

- Do not place the receiver on furniture or carpets
- Do not place any objects on top of the receiver
- Do not restrict air circulation around the receiver

**- Earthing**

- The antenna cable must be grounded

**- Foreign objects**

- Do not insert anything through the openings in the receiver, since you can touch a hazardous voltage point or damage the receiver

**- Location**

- Use the receiver indoors, to avoid damaging it by weather
- Do not install the receiver near a radiator or other heat source
- Dropping the product may result in personal injury and serious damage to the receiver

**- Lightning, storm**

- Unplug the receiver from the wall outlet and disconnect the antenna during a lightning storm or when unused for long periods of time
- This will prevent damage to the circuit due to lightning or voltage fluctuations

**- Repair**

- If it is necessary to repair, it is necessary to be sure of the qualification of the service
- Unauthorized repairs can lead to additional damage



**- FRONT PANEL:**



- **LED status indicator**

Displays the current status of the receiver (red / green)

- **Receiver of IR signals**

The sensor of the IR signals from remote control

**- REAR AND SIDES PANELS:**



- **USB 3.0**

USB 3.0 port

- **TF Card**
- **AV - Audio & Video**

Composite AV output for TV-set connection

- **SPDIF AUDIO**

Digital audio output

- **HD OUT & HDMI**

HD OUT - high quality digital audio and video output

- **LAN & ETHERNET**

Connection to Internet via LAN cable

- **DC IN-12V**

Power socket. Attention! You must use the original 12 volts power adapter included in the box!



- **USB 2.0**

Used to play media files, update software and work with WiFi / 3G dongles

















- **IR**

Plug for external IR-sensor.









- **RCOVERY**

RESET Taste für Service.

# FERNBEDIENUNG

-  Standby/On, Standby/Off
-  To change source
-  To open groups
-  To open Series
-  To open VOD
-  To open Radio
-  Open YouTube
-  Open or add to favorite' s
-  Stop
-  Play or Pause
-  Mute sound
-  Go back to previous
-  Press this key one time to run menu on screen
-  Turn on the EPG (electronic program guide)
-  Open live TV       Back Home menu
-  Shortcut Red, Green, Yellow, Blue



-  Enter number of the required menu item or select a channel number to watch
-  Popup the info bar to show the main information about the related channel
-  Volume up and down
-  change channel, Page Up/Down
-  Menu movement and control
-  To search by voice
-  Confirmation of selection
-  Program function

## Specifications

Main Chipset	Amlogic S905X3
CPU Cores	Quad-core
CPU Architecture	ARM Cortex A55
GPU	ARM Mali-450
SDRAM	2GB DDR3
Storage	32GB
Bluetooth	5.1
HDMI	HDMI2.0a TX, 4K 10bit UHD@60Hz up4096x2160px 1080p/i, 720p/i, 576p/i, 480p/i
Ethernet	RJ45 10/100M Ethernet Interface
Wi-Fi	DualBand 2.4/5GHz 802.11a/b/g/n/ac MIMO 2 built-in antennas
USB	1xUSB 3.0, 1xUSB 2.0
Ports	AV, HDMI 2.0, USB 3.0, S/PDIF, LAN 10/100Mbit DC 5V
Software	Android 9.0
Audio Support	Digital Sound 5.1, 7.1
Audio Containers Support	MP3, AAC, OGG, OGA, FLAC, ALAC, others via applications
Input Voltage	DC 12V/1A
Power Consumption	Max 12W
Power Consumption in Standby	<0.5W
Storage Temperature	-40~60C
Operating temperature	-5~45C
Humidity	<95%
Dimensions	140*91*28
Net Weight	200g

Specifications.....	24
Initialization.....	26
Launcher.....	29
Manual update firmware.....	31
New firmware remind.....	33
Private app installation and upgrade.....	34
CLAP online TV.....	35

## Initialization

This is the first screen you will see when power on the receiver, you need to press RCU "OK" button for 6 seconds to enter pairing mode (RCU will blink the led).

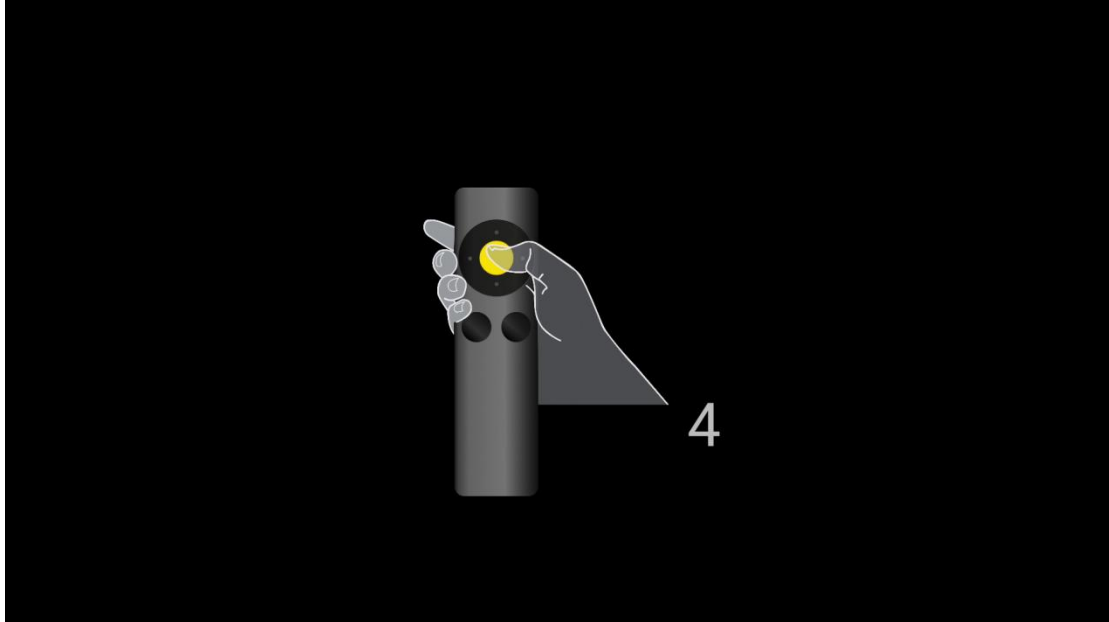

When receiver caught the RCU pairing signal, it will show pairing screen.

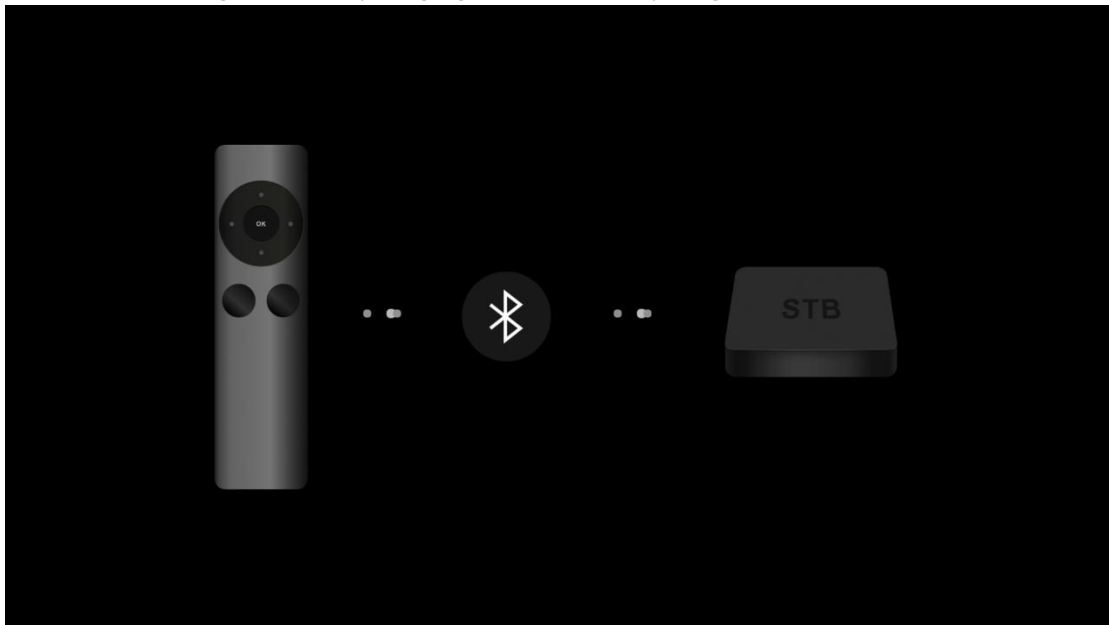

After pairing successful, it will show language selection menu.

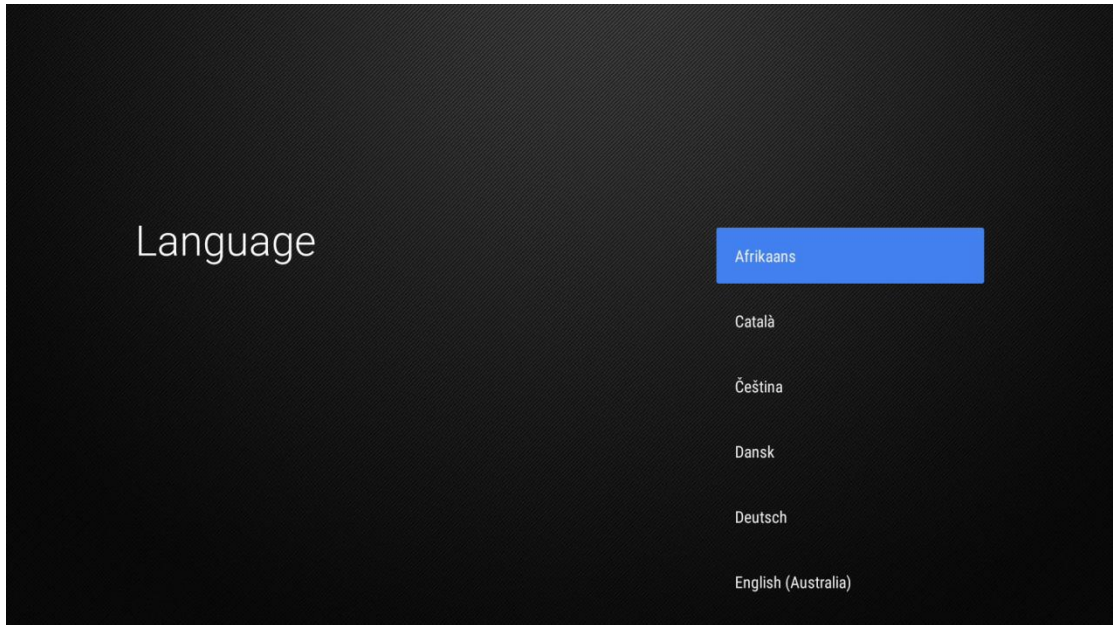

Setting internet connection by Ethernet

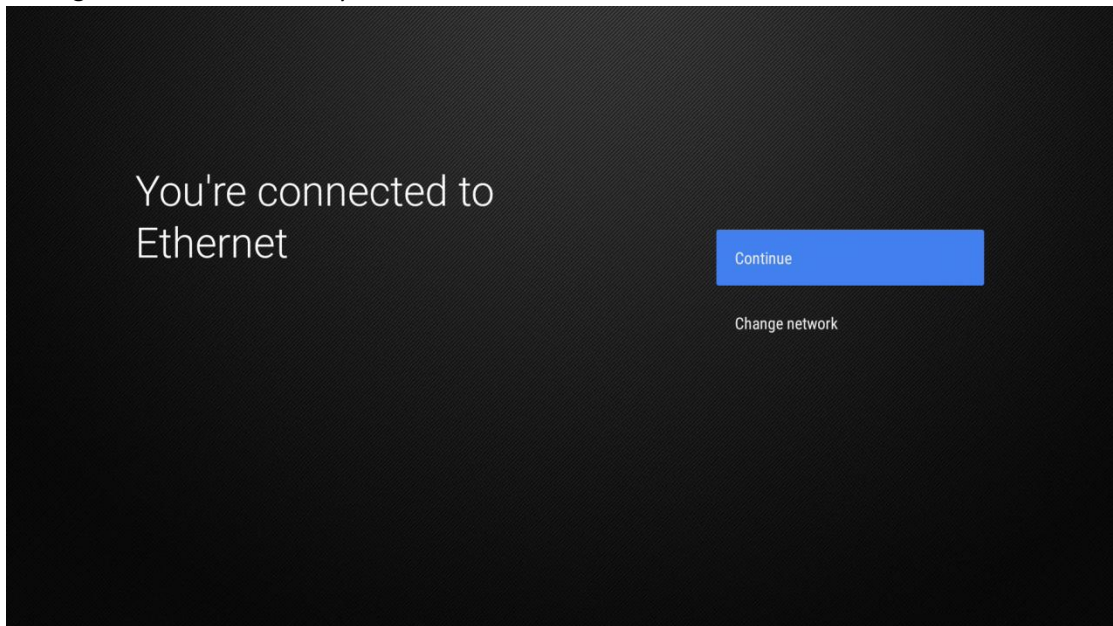

Or selection "Change network" for Wi-Fi

Select your Wi-Fi network

-  AK47
-  AK47-5G
-  ChinaNet-HEpY
-  ChinaNet-HEpY-5G
-  ChinaNet-niQy
-  NG Family

After internet connected, receiver will install the basic applications and default configuration.

Waiting for the smartupgrade to be ready





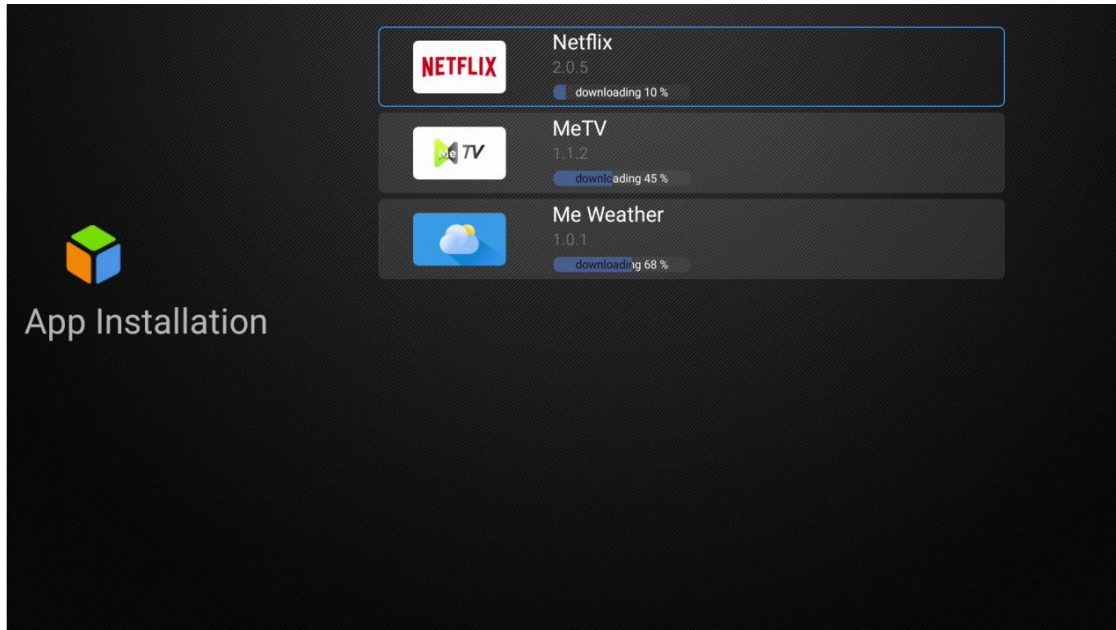

## Launcher

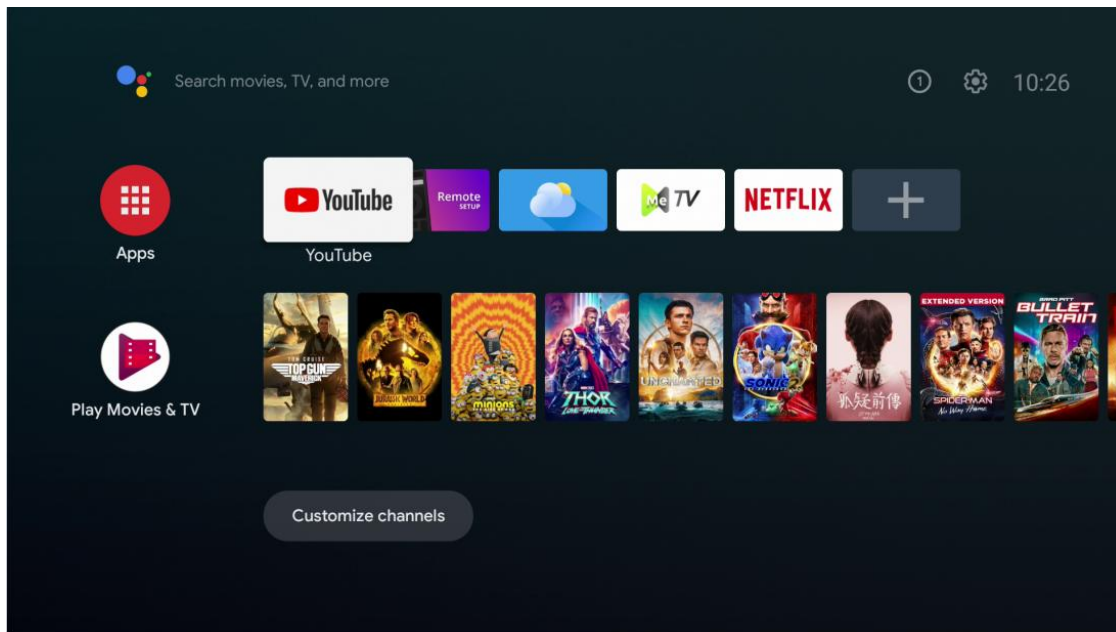

Long press "OK" button will show you the more functions, like remove, move.



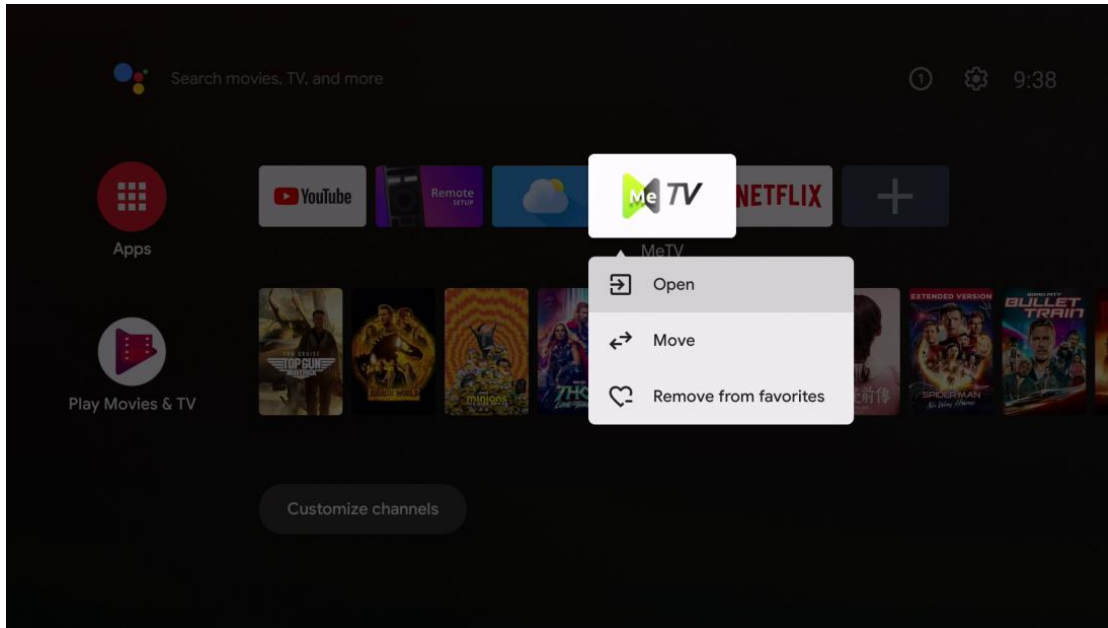

Press "+" icon, you can add more apps into launcher.

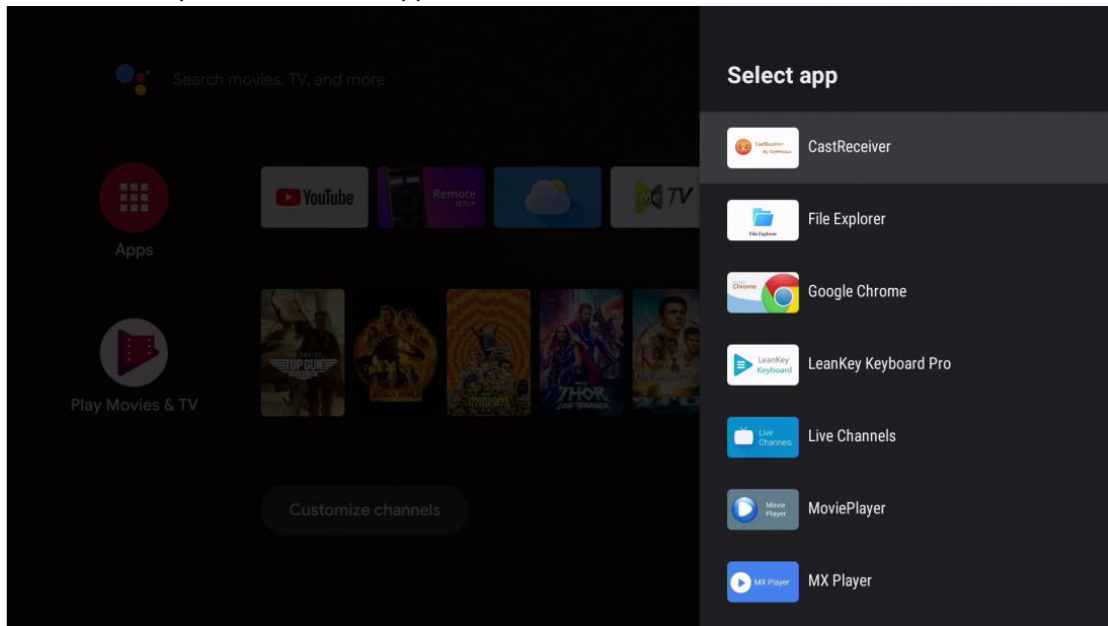

# Manual update firmware

Enter Settings > Extended settings > System Update

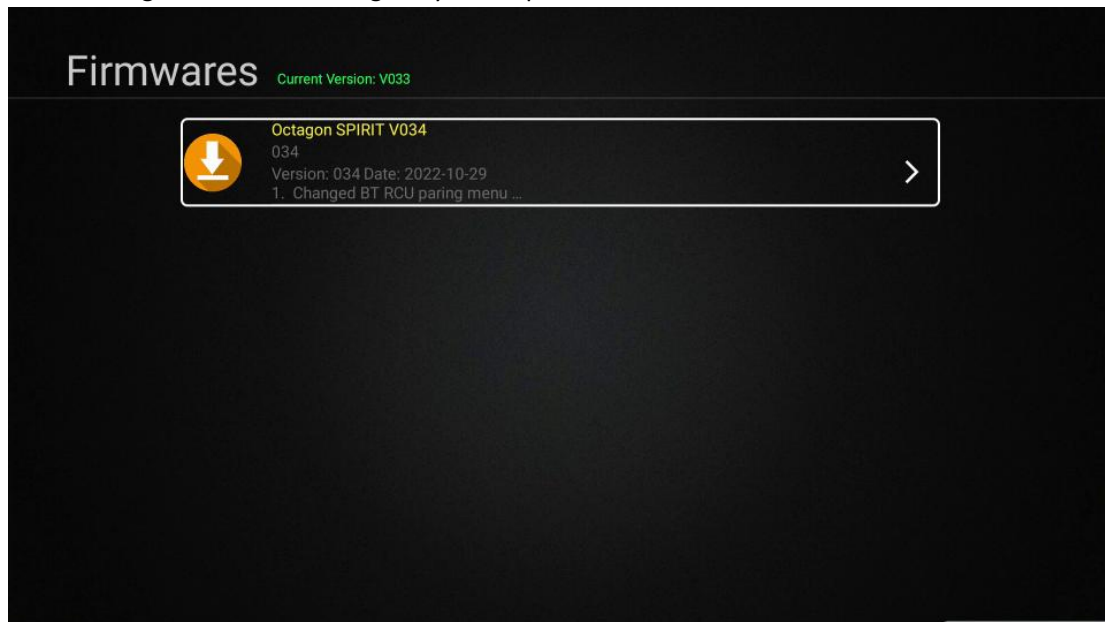

Choose one firmware, press "OK"

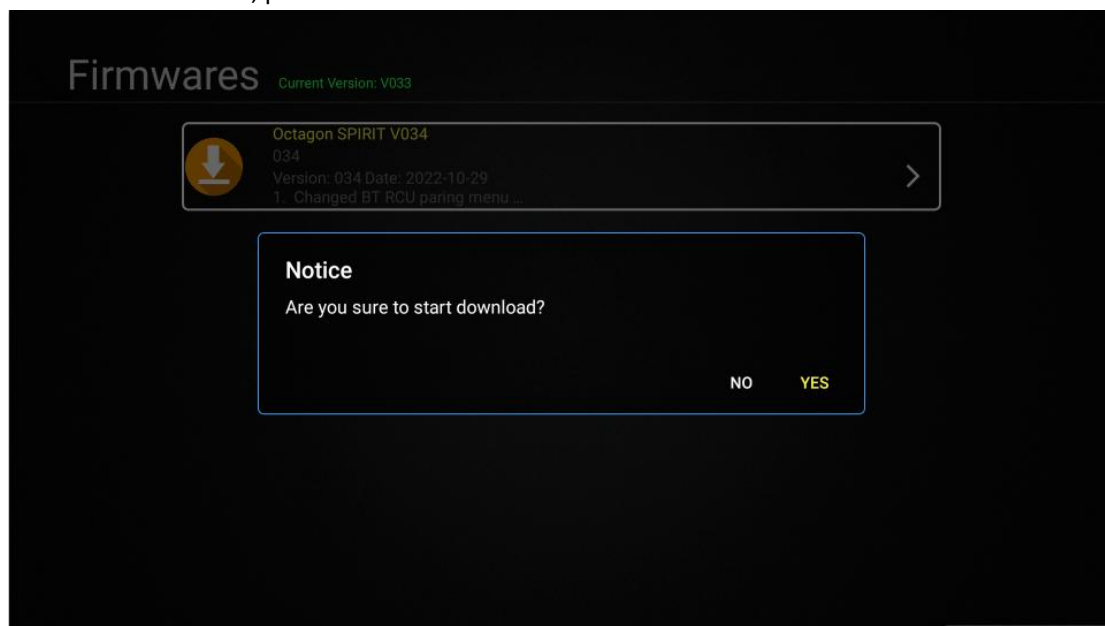

Choose "YES" to start downloading

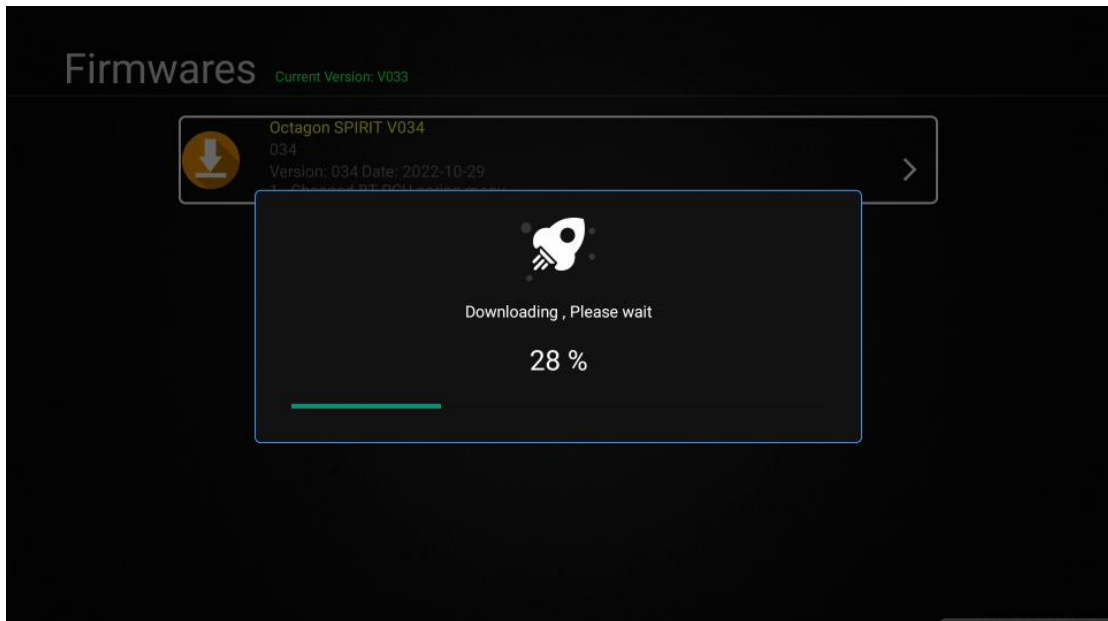

After downloading finished, it will ask you again to confirm upgrade

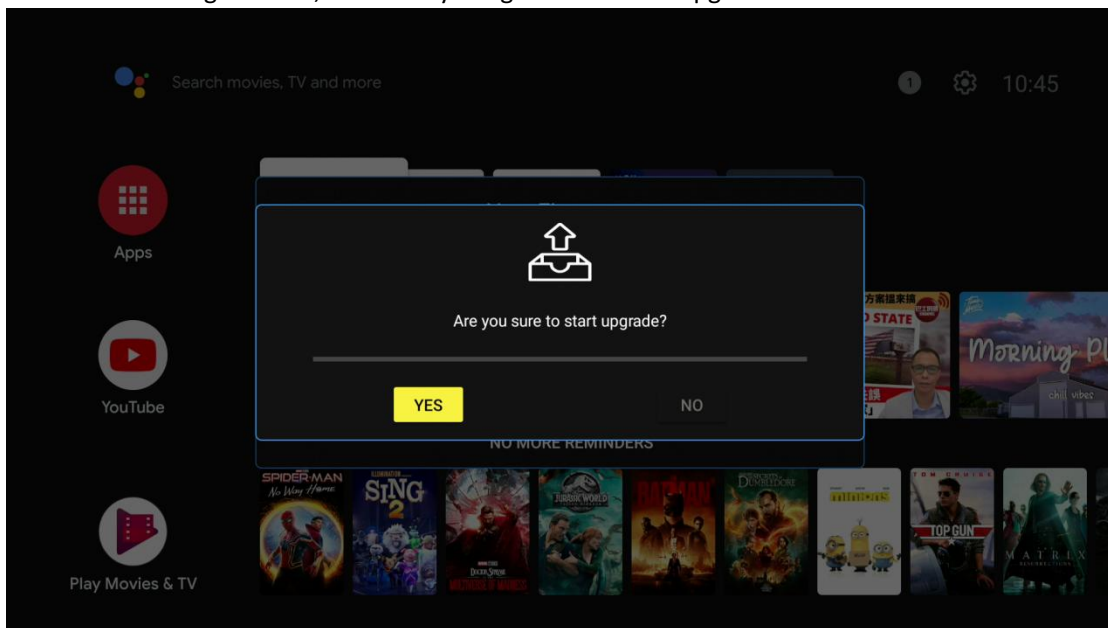

Choose "YES", it will enter upgrading

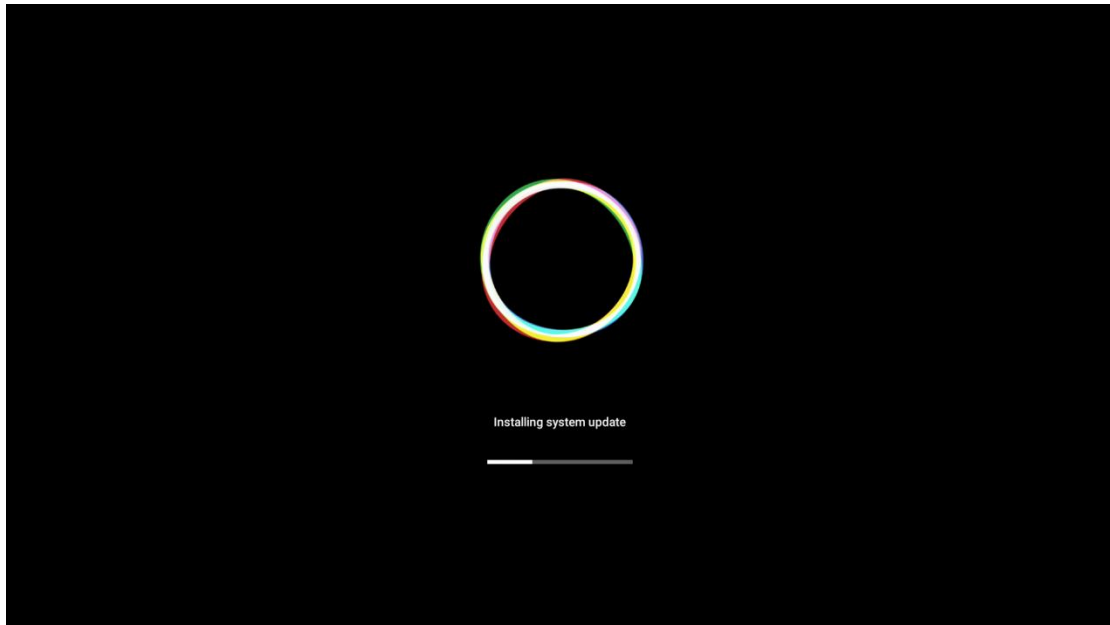

When upgrading finished, it will reboot automatic.

## New firmware remind

When new version firmware online, it will pop message

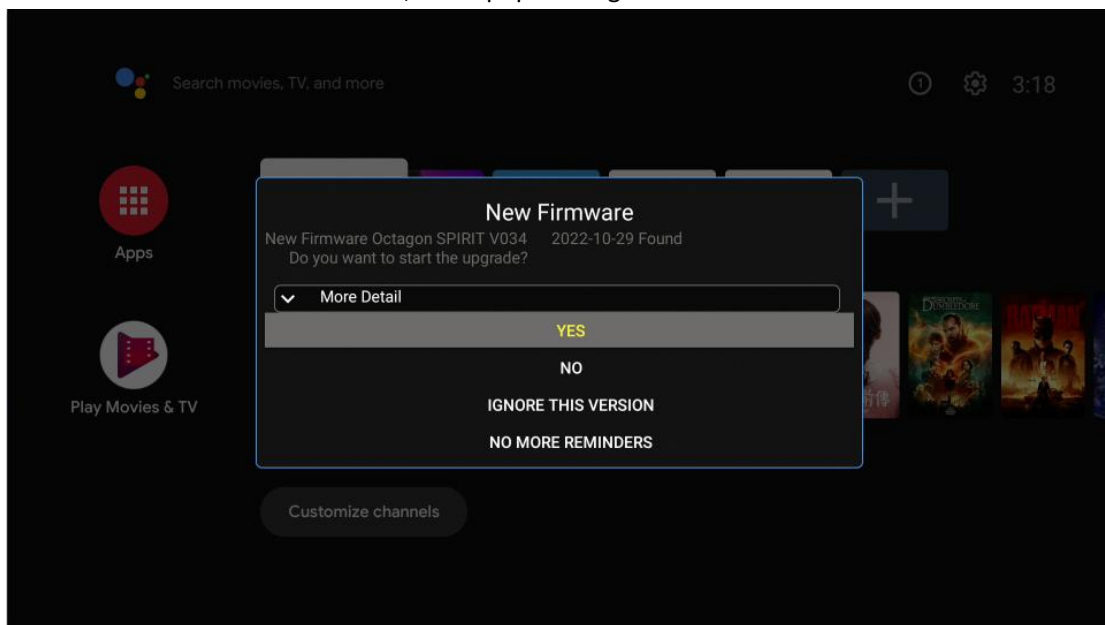

Choose "YES", it will start to download and upgrade same as "Manual update firmware".

# Private app installation and upgrade

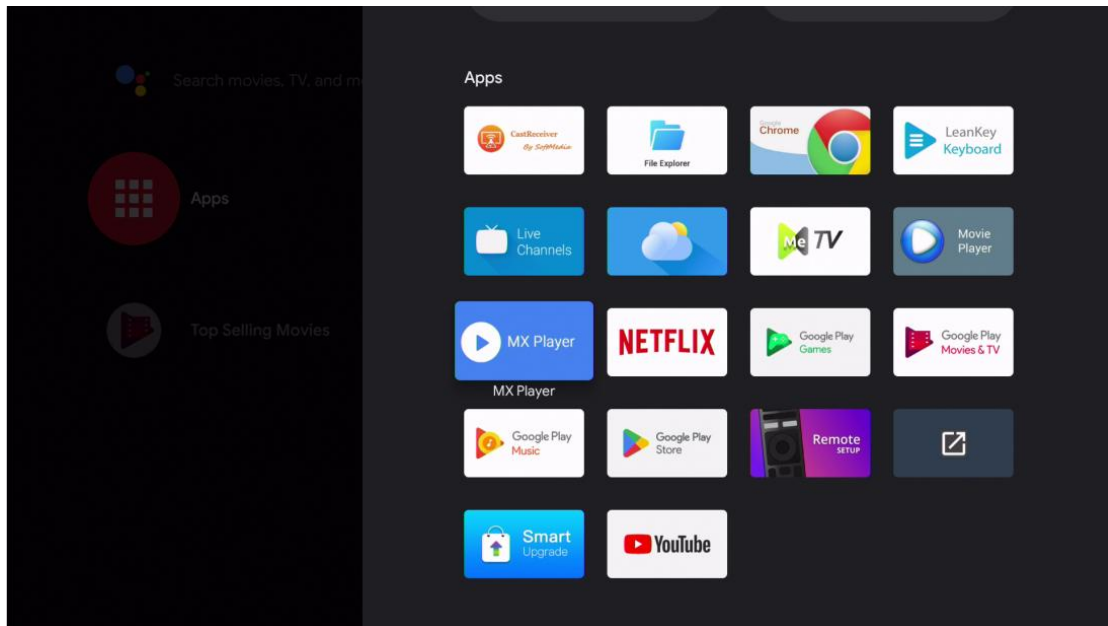

Open "Smart Upgrade" app, it will show the private app list

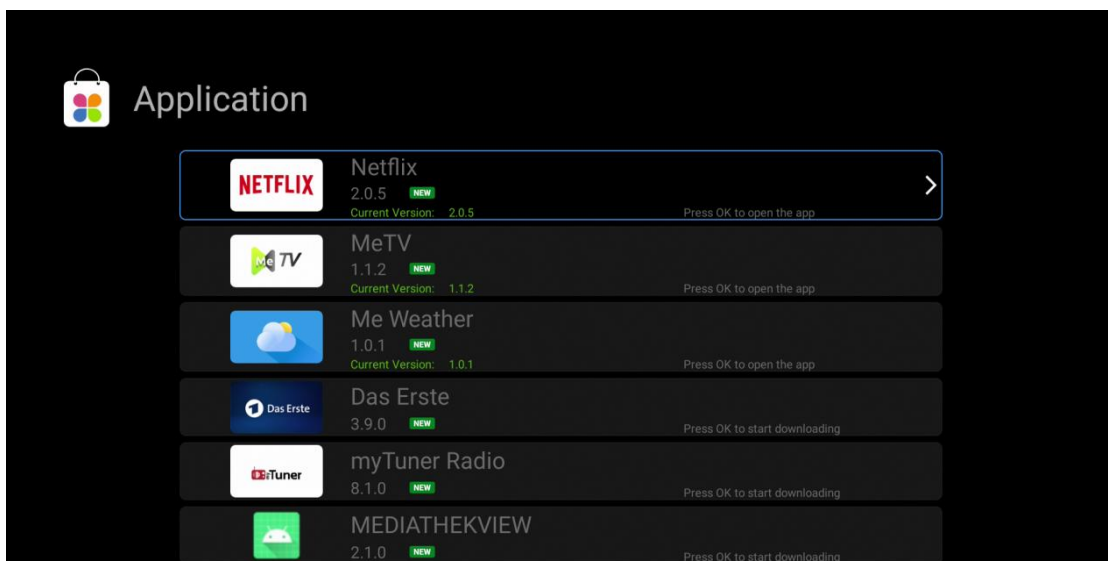

Press "RIGHT" button, you can choose one version to upgrade or downgrade

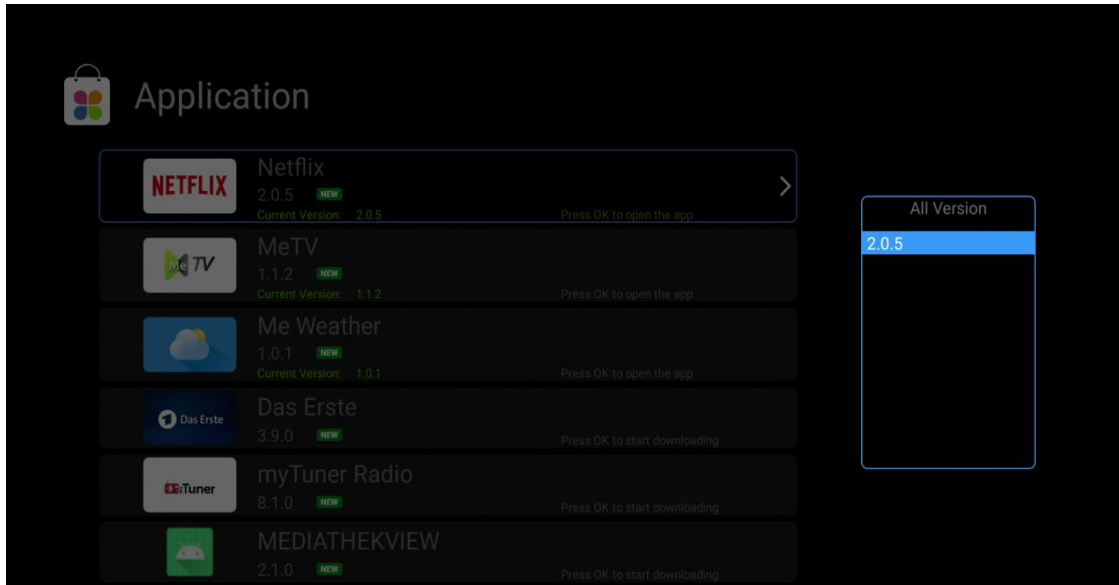

## MeTV

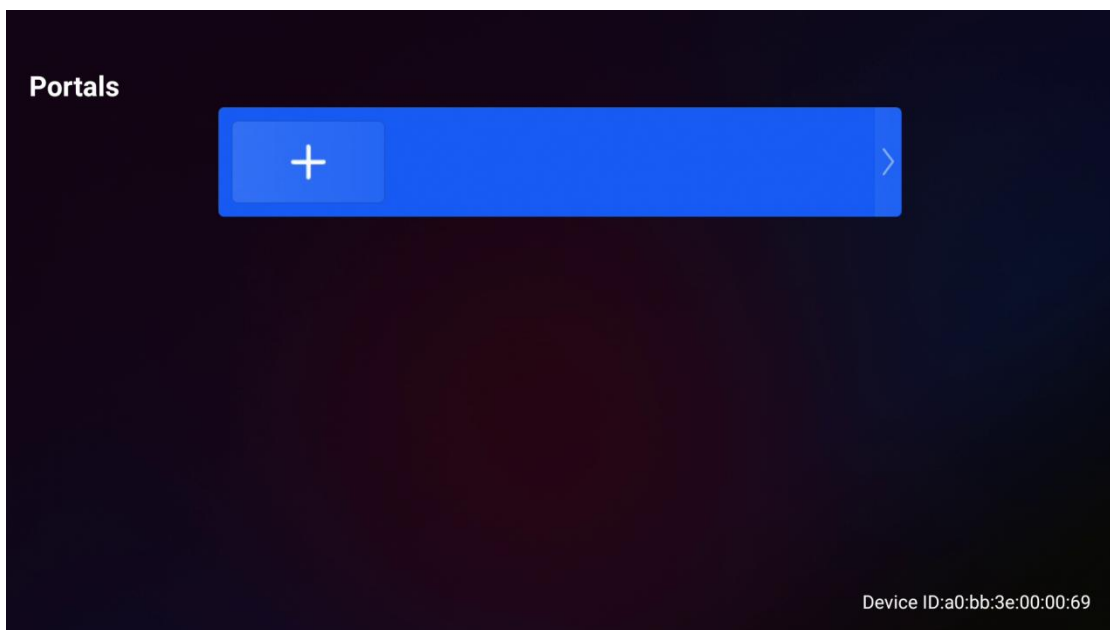

Press "RIGHT" button

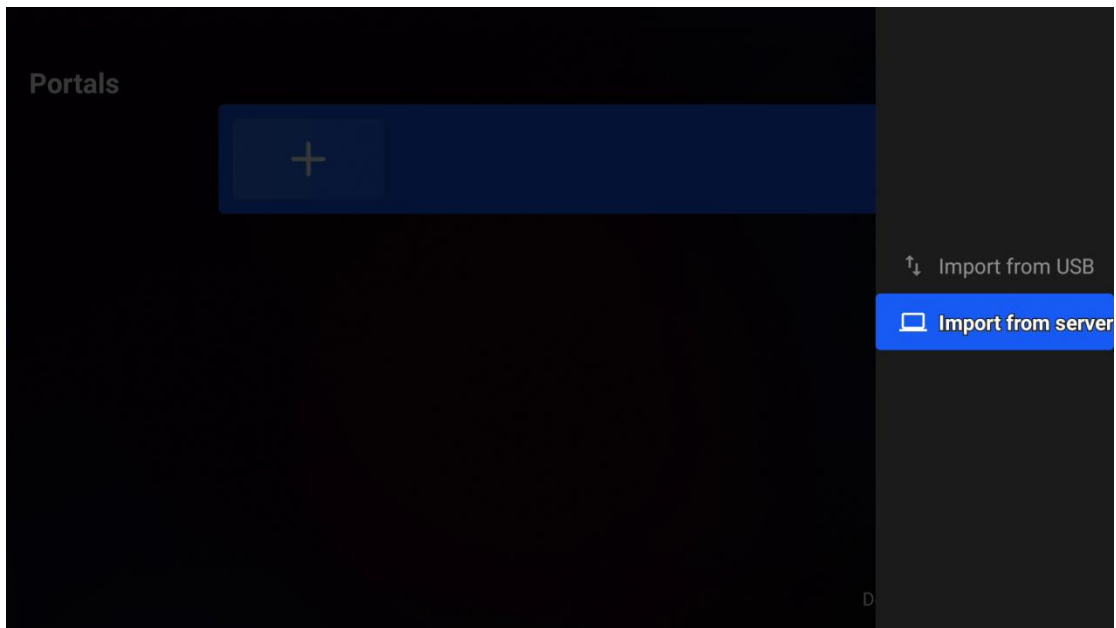

Choose "Import from USB" to install portals from USB.

Choose "Import from server" to install portals from internet.

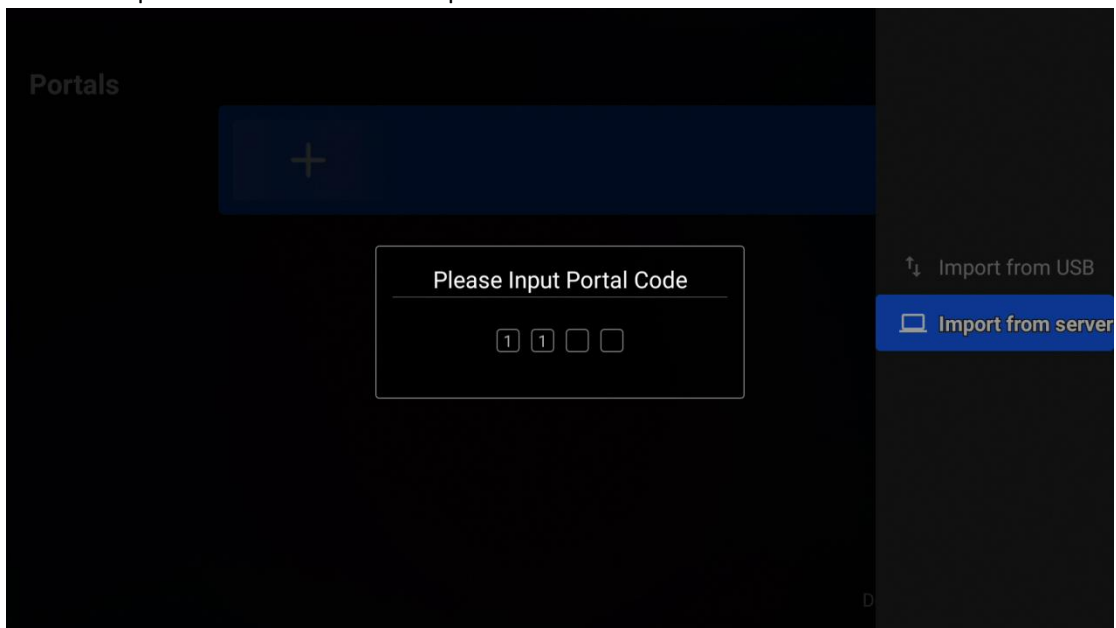

Enter "Portal code", will install the portals.

Also you can edit the portal by manual.

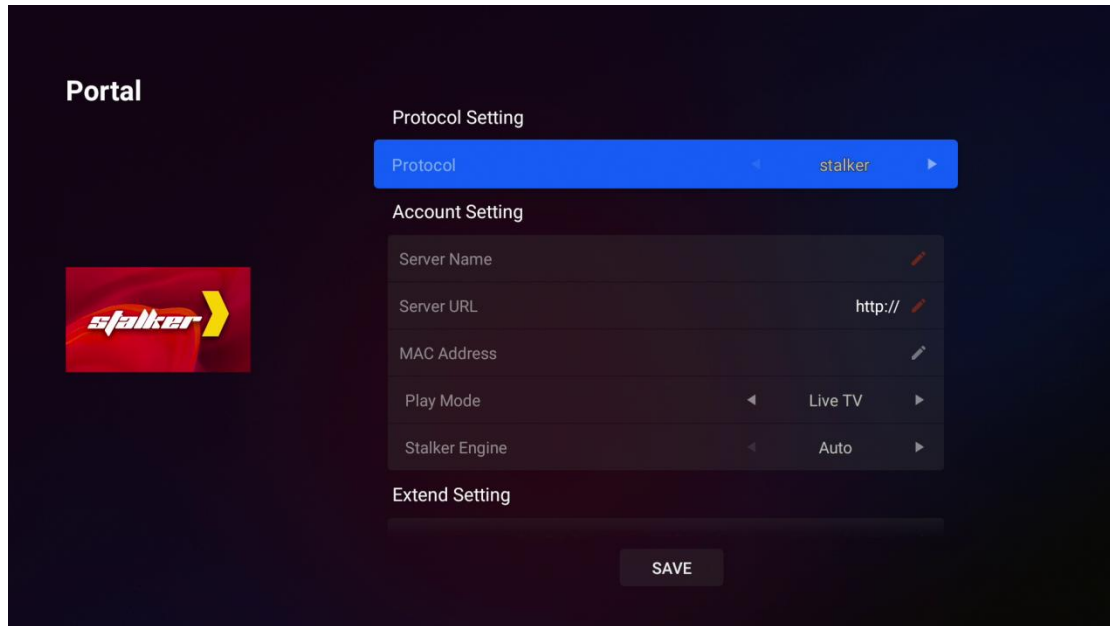

## WIFI Module:

Wlan Standard :IEEE 802.11b/g/n

Frequency Range:2.400GHz~2.497GHz(2.4GHz ISM Band)

Number of Channels:2.4GHz CH1~CH14

Modulation:802.11b DQPSK,DBPSK CCK

802.11g/n:OFDM/64QAM 16QAM QPSK BPSK

Output Power:802.11b/11Mbps:17±2dbm@EVM≤-15db

802.11g/54Mbps:15±2dbm@EVM≤-28db

802.11n/MCS7:14±2dbm@EVM≤-30db

RX sensitivity: 802.11b/11Mbps:-85dbm

802.11g/54Mbps:-72dbm

802.11 n HT20/MCS7:-70dbm

802.11n HT40/MCS7:-66dbm

Wlan Standard :IEEE 802.11a/n/ac 2x2 Wifi compliant

Frequency Range:4.900GHz~5.845GHz(5.0GHz ISM Band)

Number of Channels:5.15 GHz ~5.25 GHz(36,40,44,48)

5.25 GHz ~5.35 GHz(52,56,60,64)

5.5GHz~5.7GHz(100,104,108,112,116,120,124,128,132,136,140)

5.725 GHz ~5.825 GHz(149,153,157,161,165)

Modulation:802.11a OFDM/64QAM,16QAM,QPSK BPSK

802.11n:OFDM/64QAM 16QAM QPSK BPSK

802.11ac:OFDM/256QAM

Output Power:802.11a/54Mbps:15±2dbm@EVM≤-25db

802.11n HT20/MCS7:14±2dbm@EVM≤-28db

802.11n HT40/MCS7:14±2dbm@EVM≤-28db

802.11ac VHT20/MCS8:13±2dbm@EVM≤-30db



802.11ac VHT40/MCS9:13±2dbm@EVM≤-32db  
802.11ac VHT80/MCS9:13±2dbm@EVM≤-32db  
RX sensitivity: 802.11a/54Mbps:-72dbm  
802.11n HT20/MCS7:-69dbm  
802.11n HT40/MCS7:-67dbm  
802.11ac HT20/MCS8:-65dbm  
802.11ac HT40/MCS9:-60dbm  
802.11ac HT80/MCS9:-55dbm  
Maximum input level:802.11a/n/ac:-20dbm  
Maximum output level:802.11a/b/g/n/ac:20dbm

### **Service**

**OCTAGON Germany**

**Buendtenaecker 2**

**D-79730 Murg**

**Tel: 0049-(0)7763-704484**

**Fax: 0049-(0)7763-704483**

**E-Mail: [info@octagon-germany.de](mailto:info@octagon-germany.de)**

**Internet: [www.octagon-germany.de](http://www.octagon-germany.de)**

**Support: [www.octagon-forum.eu](http://www.octagon-forum.eu)**

**WEEE-Reg.-Nr. DE 69966297**

**[www.octagon-germany.eu](http://www.octagon-germany.eu)**

**[www.octagon-forum.eu](http://www.octagon-forum.eu)**