



VARIN[®]

VARIN[®] FLOOR LAMP WITH SHELVES

Material: Pine Wood & Linen

Dimensions: 160 x 26 x 26 cm

Lamp base: E27

Maximum wattage: 60W

Input Voltage: AC 100-240V~50/60Hz

Model: KL-1734WF-A

Optional:

**Tuya Smart / Smart Life App instructions
for WiFi lamp**

Importer:

Varin - Veenweg 22 - 8075 PS - Elspeet

The Netherlands



RoHS



Made in PCR

V A R I N[®]



FLOOR LAMP WITH SHELVES MODEL: KL-1734WF-A

USER MANUAL

Latest update 08/2022

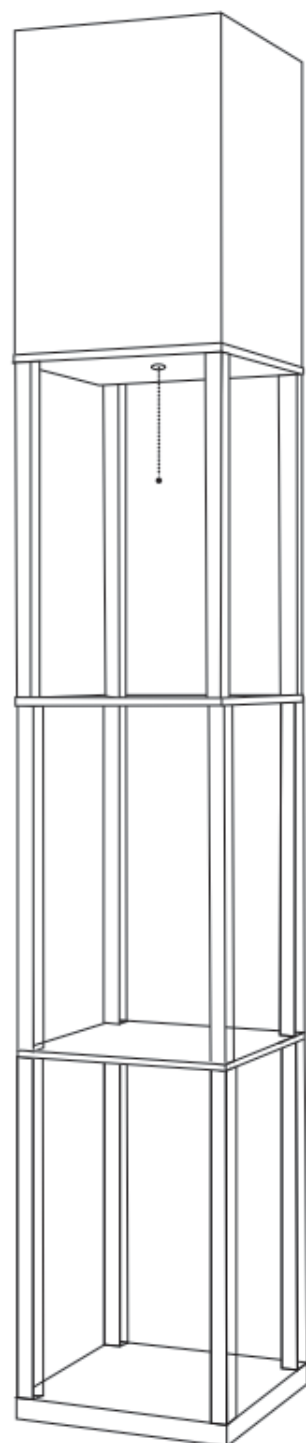

EN

NL

FR

DE



Please read this manual - Keep these instructions for future reference

Lees deze handleiding - Bewaar deze instructies voor toekomstig gebruik

Veillez lire ce manuel - Conservez ces instructions pour référence future

Bitte lesen Sie dieses Handbuch - Bewahren Sie diese Anleitung zum späteren Nachschlagen



EN-SAFETY INSTRUCTIONS

Please read the following carefully before us!

- Do not look directly at the light source to avoid eye discomfort.
- This lamp is for indoor use only.
- Keep out of reach of children and animals.
- Place the lamp on flat surface and ensure placed away from flammable materials.
- Before cleaning the lamp, ensure it is switched off.
- Do not pull the plug out of the socket with wet hands.
- If the supply cord is damaged it must be replaced by manufacturer or electrical qualified person to avoid a hazard.
- The light source of this product are non-replaceable light emitting diodes (LED). Do not disassemble the product, as the LEDs may cause damage to the eyes.
- Do not use in bathroom or wet/moist places.



NL-VEILIGHEIDSINSTRUCTIES

Lees het volgende aandacht door voor gebruik!

- Kijk niet direct in de lichtbron om ongemak aan de ogen te voorkomen.
- Deze lamp is alleen voor gebruik binnenshuis
- Buiten het bereik van kinderen en dieren houden.
- Plaats de lamp op een vlakke ondergrond en zorg ervoor dat deze uit de buurt van brandbare materialen wordt geplaatst.
- Controleer voordat u de lamp reinigt of deze is uitgeschakeld.
- Trek de stekker niet met natte handen uit het stopcontact.
- Als het netsnoer beschadigd is, moet het worden vervangen door de fabrikant of een elektrisch gekwalificeerd persoon om gevaar te voorkomen.
- De lichtbron van dit product zijn niet-vervangbare lichtgevende diodes (LED). Haal het product niet uit elkaar, aangezien de LED's schade aan de ogen kunnen veroorzaken.
- Niet gebruiken in badkamer of natte/vochtige plaatsen.



FR-CONSIGNES DE SÉCURITÉ

Veillez lire attentivement ce qui suit avant nous!

- Ne regardez pas directement la source lumineuse, pour éviter toute gêne oculaire
- Cette lampe est destinée à un usage intérieur uniquement.
- Tenir hors de portée des enfants et des animaux.
- Placez la lampe sur une surface plane et assurez-vous qu'elle est placée à l'écart des matériaux inflammables.
- Avant de nettoyer la lampe, assurez-vous qu'elle est éteinte.
- Ne débranchez pas la fiche de la prise avec les mains mouillées.
- Si le cordon d'alimentation est endommagé, il doit être remplacé par le fabricant ou une personne qualifiée en électricité pour éviter tout danger.
- La source lumineuse de ce produit est constituée de diodes électroluminescentes (DEL) non remplaçables. Ne démontez pas le produit, car les LED peuvent endommager les yeux.
- Ne pas utiliser dans la salle de bain ou dans des endroits mouillés/humides.



DE-SICHERHEITSHINWEISE

Bitte lesen Sie das Folgende sorgfältig vor uns!

- Schauen Sie nicht direkt in die Lichtquelle, um Augenbeschwerden zu vermeiden!
- Nur für den Innengebrauch bestimmt.
- Halten sie die Lampe aus der Reichweite von Kindern und Tieren.
- Stellen Sie die Lampe auf flachen Oberflächen und nicht in der Nähe von entzündlichen Materialien auf.
- Bevor Sie die Lampe reinigen, stellen Sie sicher, dass sie ausgeschaltet wurde.
- Ziehen Sie nicht am Stecker mit nassen Händen.
- Wenn das Netzkabel beschädigt ist, muss es vom Hersteller oder einer qualifizierten Elektriker ersetzt werden, um Gefahren zu vermeiden.
- Die Lichtquelle dieses Produkts sind nicht austauschbare Leuchtdioden (LED). Zerlegen Sie das Produkt nicht, da die LEDs die Augen schädigen können.
- Nicht im Badezimmer oder an nassen/feuchten Orten aufstellen.



EN-INSTALLATION STEPS | NL-INSTALLATIE STAPPEN FR-ÉTAPES D'INSTALLATION | DE-INSTALLATIONSSCHRITTE

THESE ARE PARTS INCLUDED IN THE BOX | DEZE ONDERDELEN ZITTEN IN DE DOOS

CE SONT DES PIÈCES INCLUSES DANS LA BOÎTE | DIES SIND DIE TEILE, DIE IN DER SCHACHTEL ENTHALTEN SIND

A

1x | Bottom shelf
Onderste plank
Étagère inférieure
Grundboden

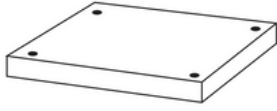

B

2x | Shelf
Plank
Étagère
Regal

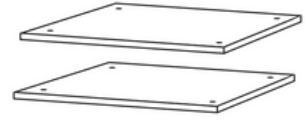

C

12x | Pole part
Paal delen
Partie polaire
Stangenteil



D

1x | Lamp holder shelf
Lamphouder plank
Étagère porte-lampe
Regal Lampenhalter

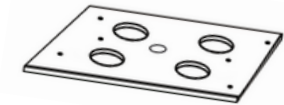

E

1x | Tool
Gereedschap
Outil
Werkzeug



F

10x | Large screw
Grote schroef
Grosse vis
Große Schraube



G

10x | Double-sided screw
2-zijdige schroef
Vis double face
2-seitige Schraube



H

4x | Round cushions
Ronde viltjes
Coussins ronds
Runde Polster

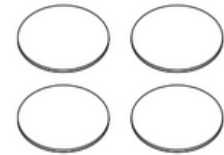

I

1x | Lamp holder
Lamphouder
Support de lampe
Lampenhalter

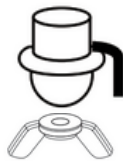

J

1x | Shade brackets
Kap beugels
Supports d'abat-jour
Schattenhalter

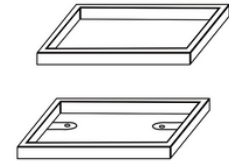

K

1x | Fabric shade
Linnen kap
Abat-jour en tissu
Schirm aus Stoff

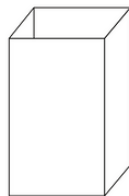

L

3x | Small screw
Kleine schroef
Petite vis
Kleine Schraube



M

2x | Wing nut
Vleugelmoer
Écrou papillon
Flügelmutter



N

4x | Cord clips
Kabelclips
Clips de cordon
Schnur-Clips



Some extra fasteners are included | er zijn wat extra bevestigingsmiddelen meegeleverd

Certaines attaches supplémentaires sont incluses | Einige zusätzliche Befestigungselemente sind enthalten



STEPS 1-4 | STAPPEN 1-4

ÉTAPES 1-4 | SCHRITTE 1-4

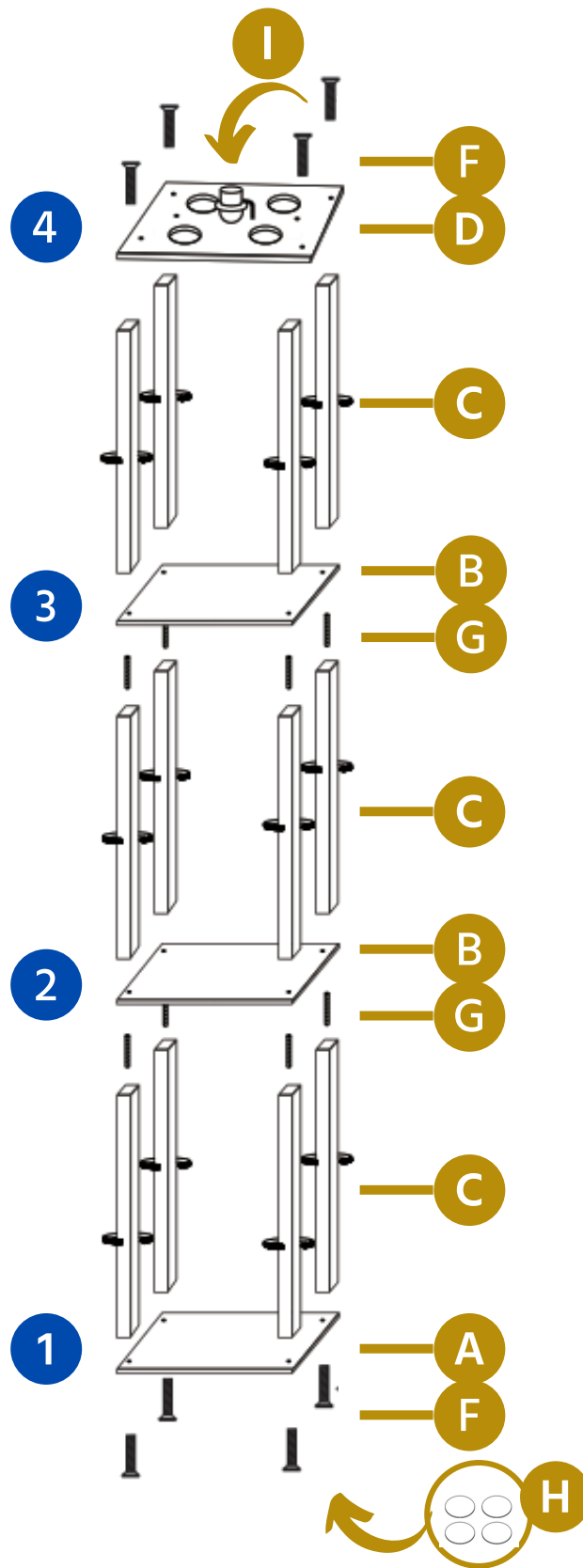

EN-Assemble from bottom to top & rotate the poles so the board is connected to the pole.

NL-Monteer van onder naar boven & Draai de paal zodat de plank met de paal is verbonden.

FR-Assembler de bas en haut & Faites pivoter le poteau pour que la carte soit connectée au poteau.

DE-Von unten nach oben zusammenbauen & Drehen Sie die Stange so, dass die Regal mit der Stange verbunden ist.



STEPS 5-7 | STAPPEN 5-7
ÉTAPES 5-7 | SCHRITTE 5-7

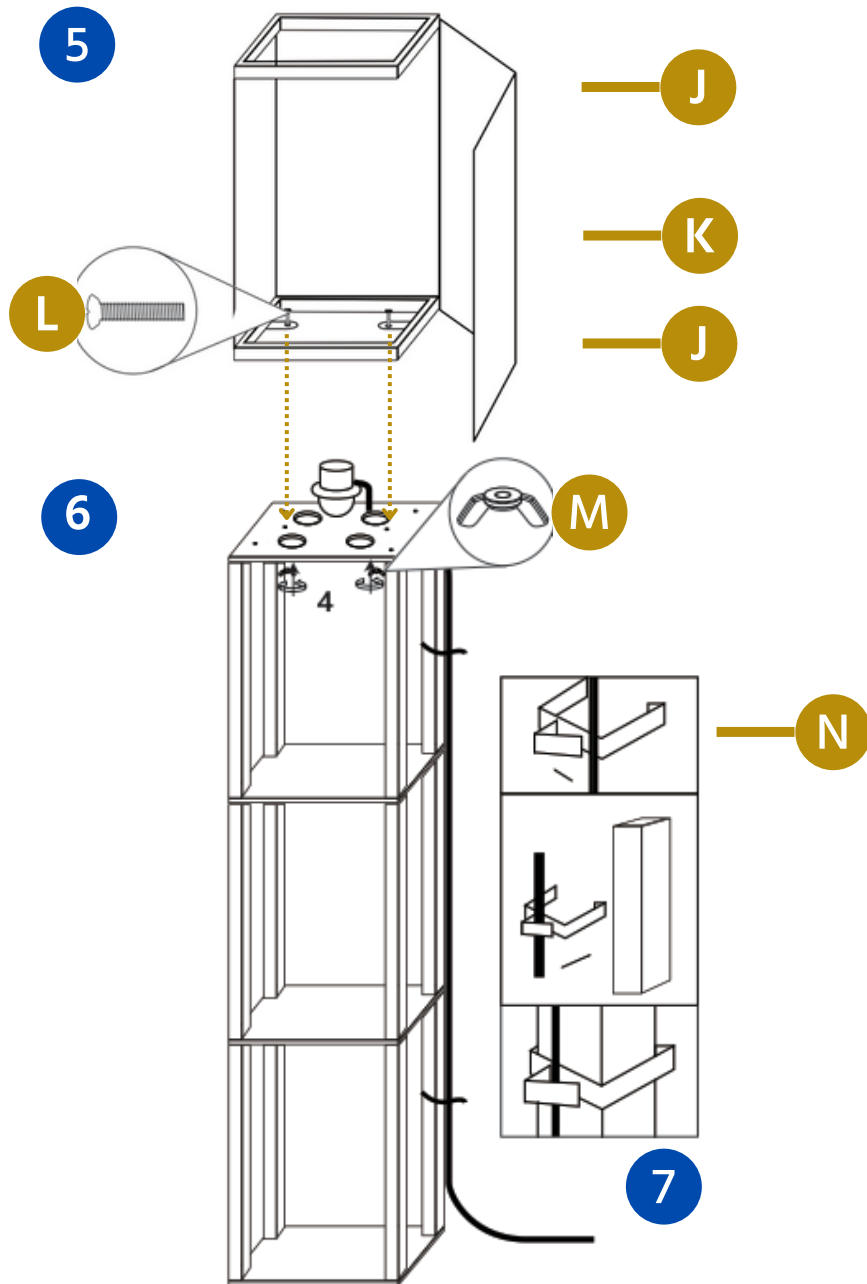

EN-Be careful with the linen shade & place the lamp with velcro corner and the cable on the least visible side.

NL-Wees voorzichtig met de linnen kap & plaats de lamp met klittenband hoek en de kabel aan minst zichtbare zijde.

FR-Faites attention à l'abat-jour en lin et placez la lampe avec le coin velcro et le câble du côté le moins visible.

DE-Seien Sie vorsichtig mit dem Leinenschirm und platzieren Sie die Lampe mit Klettverschluss und das Kabel auf der am wenigsten sichtbaren Seite.



! EN-These are optional instructions, only applicable when a Tuya WiFi LED Bulb is added to the package.

! NL-Dit zijn optionele instructies, alleen van toepassing wanneer een Tuya WiFi LED-lamp aan het pakket is toegevoegd.

FR-Ce sont des instructions facultatives, applicables uniquement lorsque l'ampoule LED WiFi Tuya est ajoutée au colis.

DE-Dies sind optionale Anweisungen, die nur anwendbar sind, wenn Tuya WiFi LED Bulb dem Paket hinzugefügt wird.

! EN-The app is working in 60+ languages, the instruction below is in English, but the pictures shows all steps and possibilities.

NL-De app werkt in meer dan 60 talen, de onderstaande instructie is in het Engels, maar de foto's tonen alle stappen en mogelijkheden.

FR-L'application fonctionne dans plus de 60 langues, les instructions ci-dessous sont en anglais, mais les images montrent toutes les étapes et possibilités.

DE-Die App funktioniert in über 60 Sprachen, die Anleitung unten ist auf Englisch, aber die Bilder zeigen alle Schritte und Möglichkeiten.

1 Download app

Scan QR code or download "Tuya Smart"
in Google Play / App Store
Alternative: de lamp can also be operated with the "Smart Life" app



Tuya Smart App



Smart Life App



2 Tuya Smart or Smart Life APP

1. Open the APP
2. Make an account, the first time
3. Press the orange "+" at the top right > Add Device
4. Click on "Lighting" left
5. Select "Bulb (Wi-Fi)" right

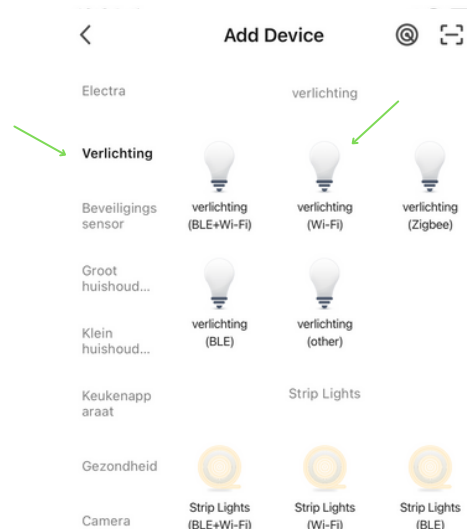
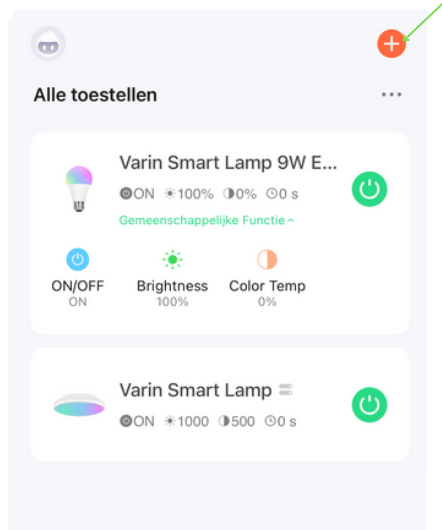

3

6. Reset the lamp, see app instructions
7. Connect with Wi-Fi network

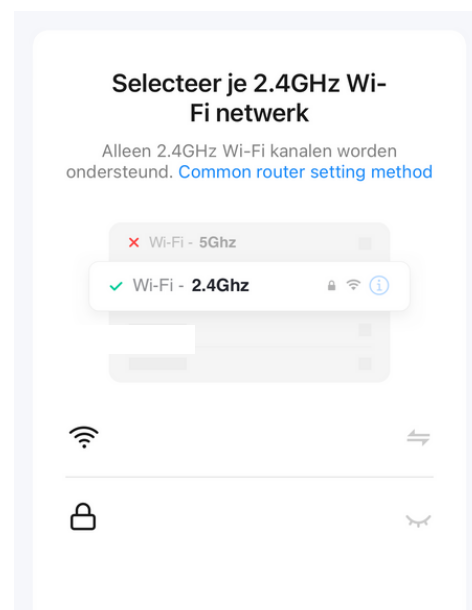
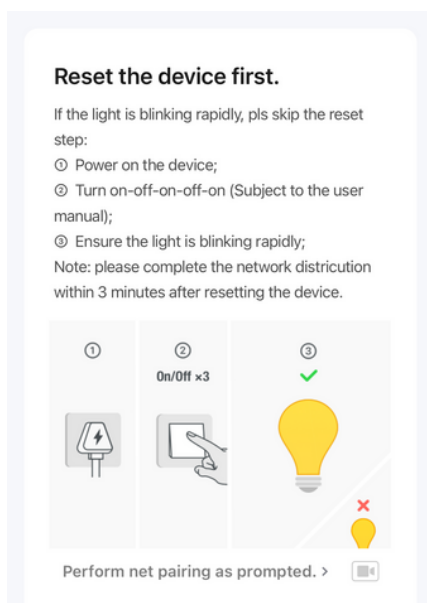



4

8. Lamp is paired

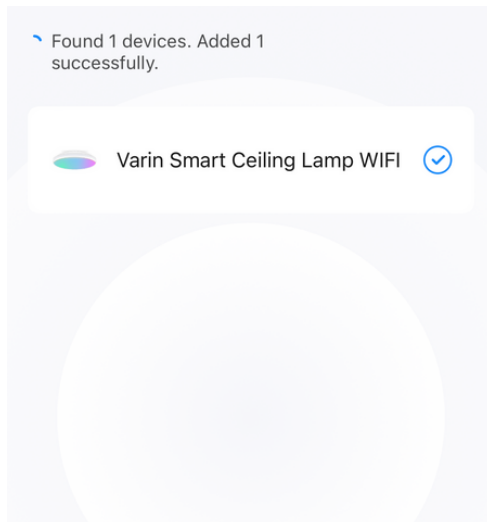

9. Lamp has been added and name can be changed



5

10. Adjust the color by clicking and the brightness by sliding

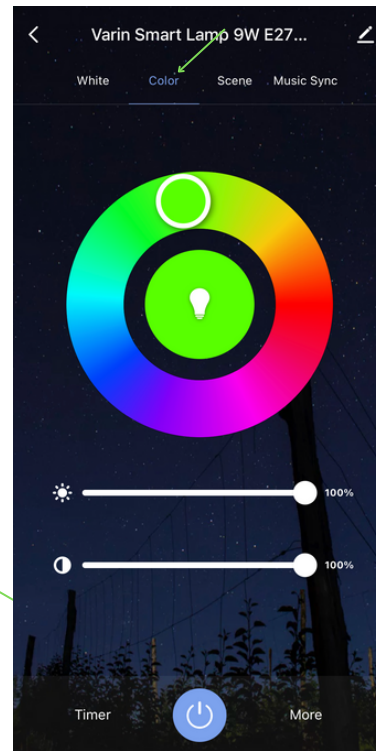
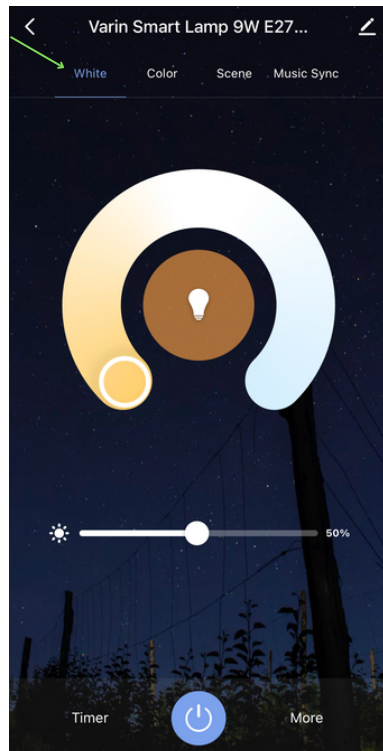



6

11. Choose scenes

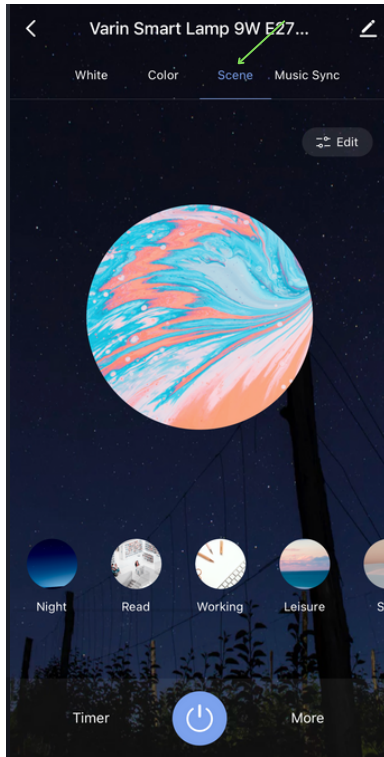

12. Set plans/time schedules

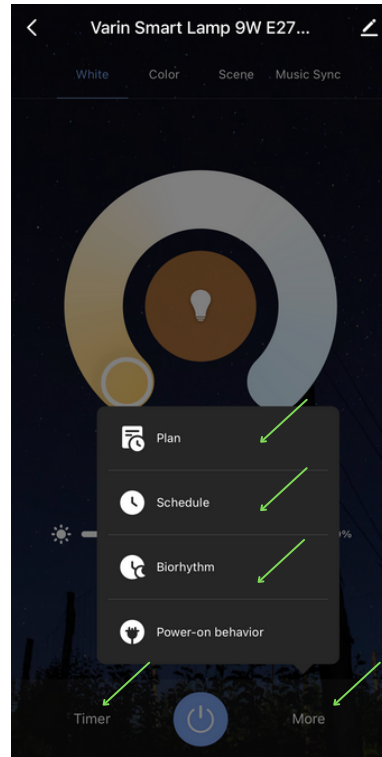

7

13. Set light mode for wall or cord switch

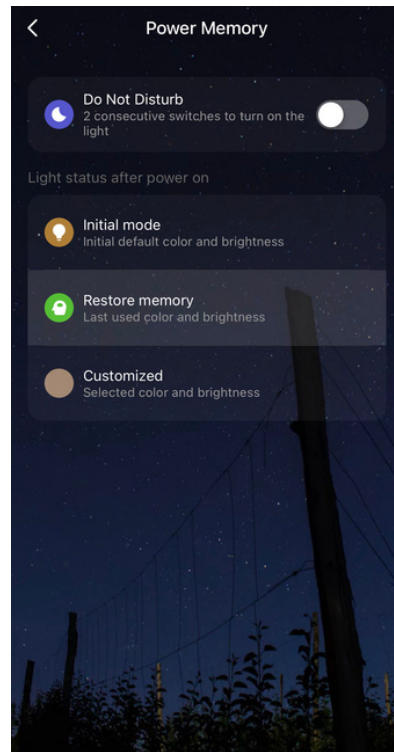
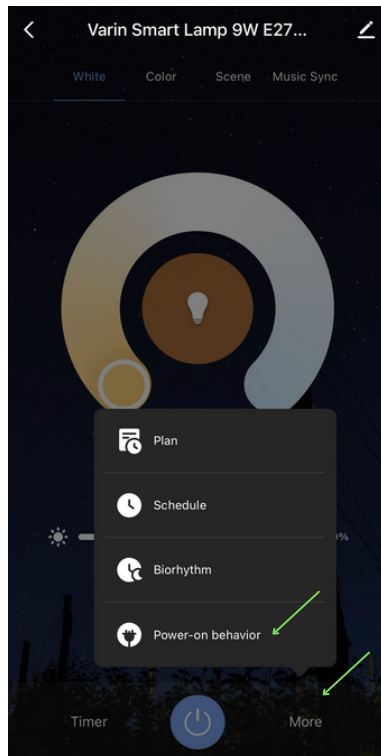



8

14. Customize lamp name / create group(s)

Varin - Slaapkamer 

Toestel Info >

Tap-to-Run en Automatisering >

Ondersteunde Apparatuur Van Derden



Alexa



Google Assistant



XIAODU



Tmall Genie

Melding Bij Offline

Melding Bij Offline

Andere

Toestel Delen >

Creëer Groep >

FAQ & Feedback >

Toevoegen aan beginscherm >

15. Pair with Alexa or Google Assistant

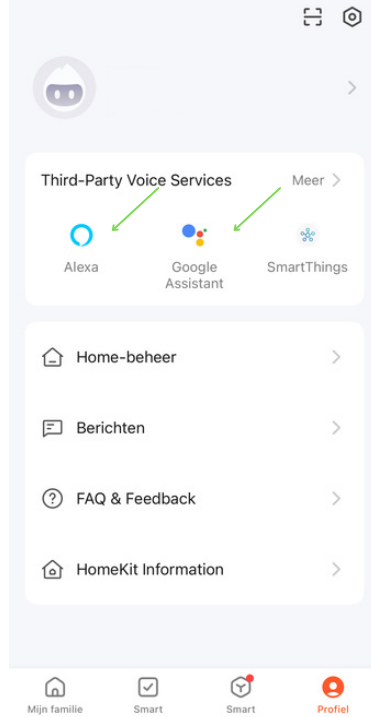



EN-APP INSTRUCTIONS | NL-APP INSTRUCTIES FR-INSTRUCTIONS APP | DE-APP ANWEISUNGEN



EN-Space for notions related to app use and configuration smart lamps and products.

NL-Ruimte voor notities met betrekking tot app-gebruik en configuratie smart lampen en andere smart producten.

FR-Espace pour les notions liées à l'utilisation et à la configuration des lampes et produits intelligents de l'application.

DE-Platz für Anmerkungen zur App-Nutzung und Konfiguration intelligenter Lampen und Produkte.