

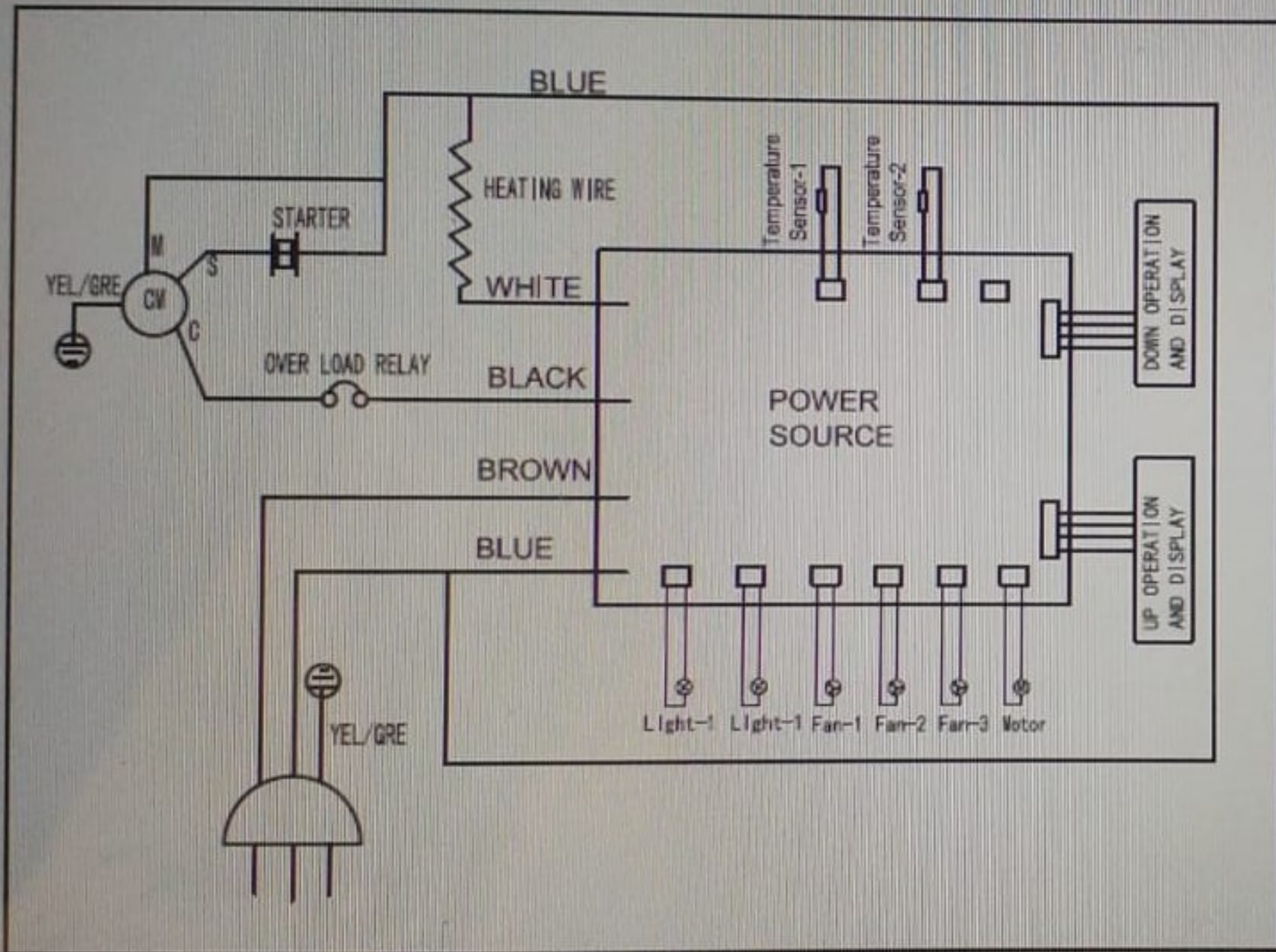

WINE COOLER



Model	B4324
Temp.Zone	2
Cliamate	ST
Protect	I
Volume	68L
Gas	R600a/23g
Voltage	220~240V/50Hz
current	0.4A
Daily energy consumption AE	0.372kW.h/24h
Daily energy consumption E16°C	0.128kW.h/24h
Daily energy consumption E32°C	0.616kW.h/24h
Blowing agent	C ₅ H ₁₀