







# Assembly Instruction

NO.	PICTURE	QTY
A		1PC
B		2PCS
C		4PCS
D		2PCS
E		40PCS
F		40PCS
G		1PC

STEP1

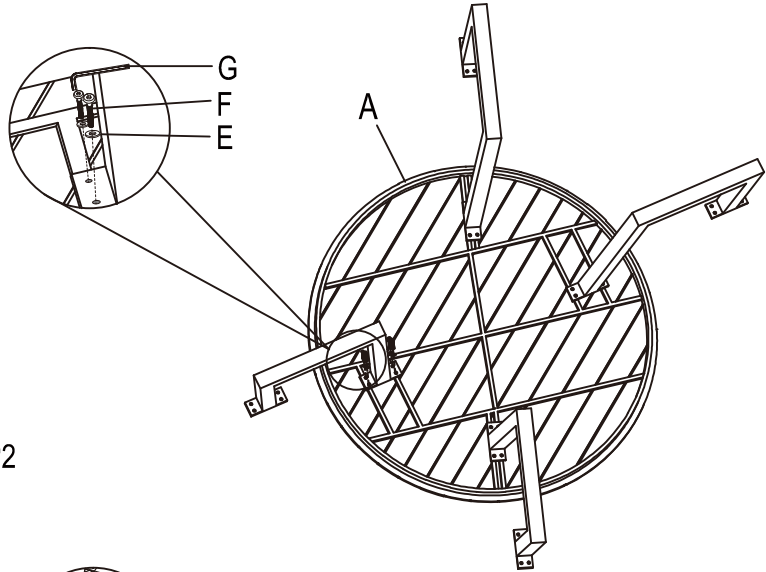

STEP2

