



JUNIORS

EASY TO BUILD



10737



LEGO.com/juniors



DC COMICS™



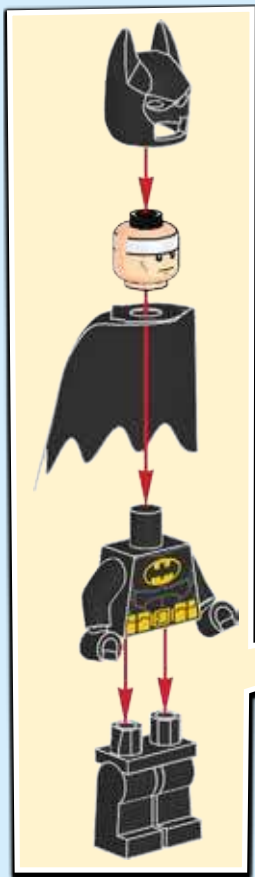



1x



1x



1x



1x



1x

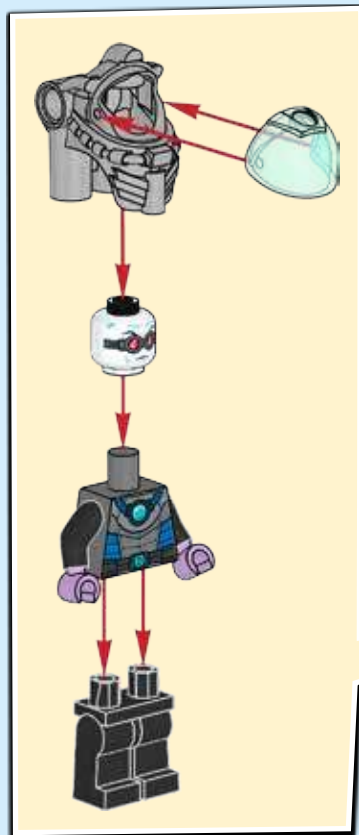

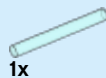

1



2



3



4

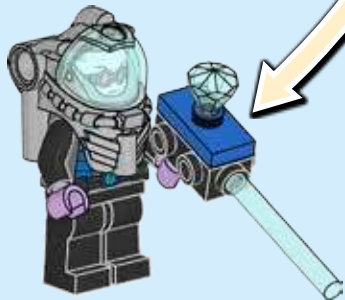
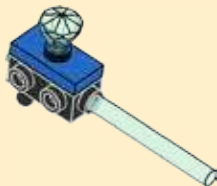



1x



1x

1

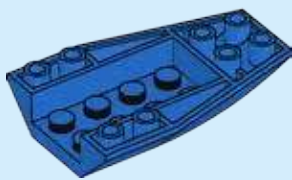

2

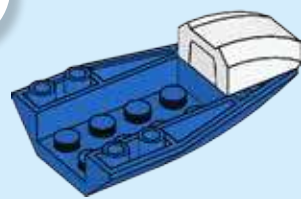

3

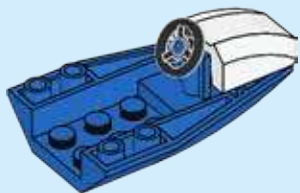

4

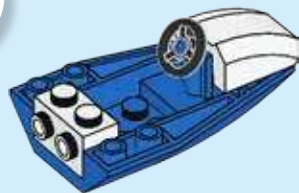

1x



1x



1x



2x

5

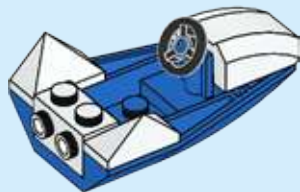

6



1



2



1x



1x



1x



1x



1x

3

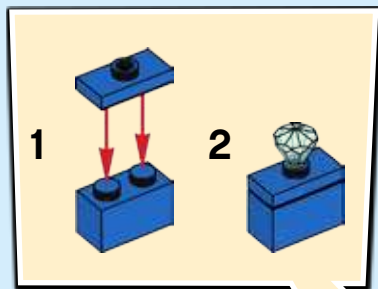

4



2x

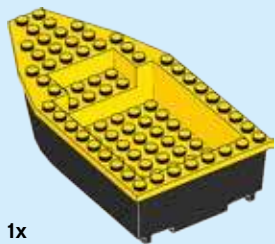

1x



1x



1

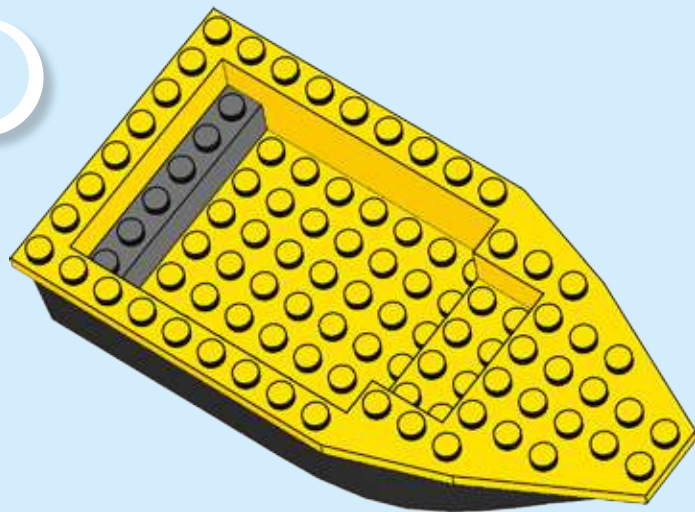

2

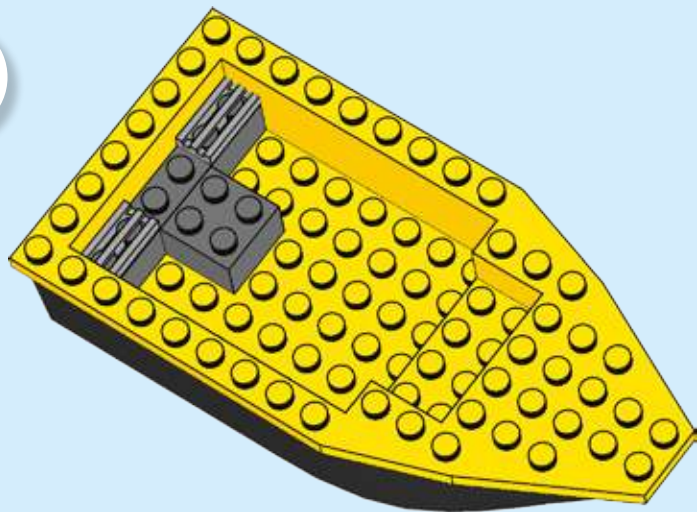



2x

3

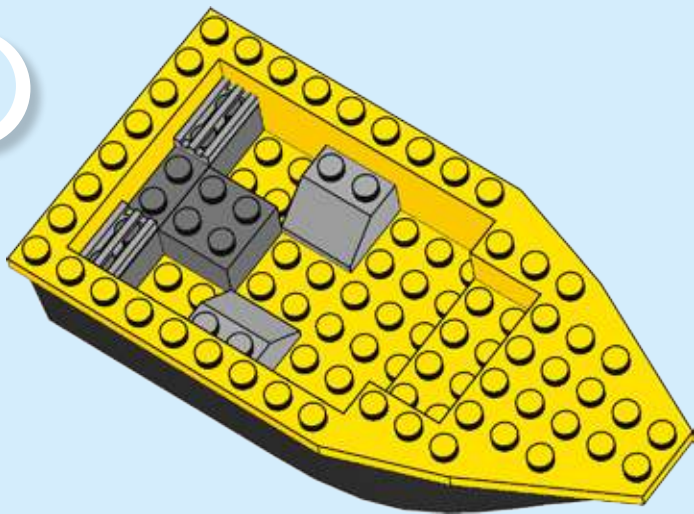

4

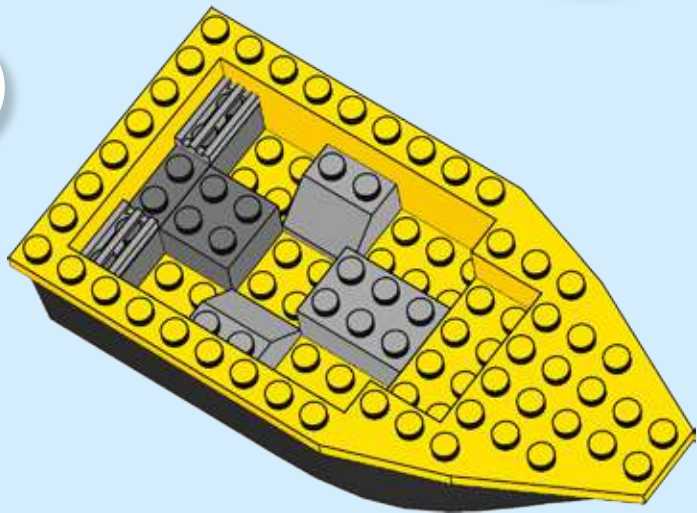

1x



1x

5

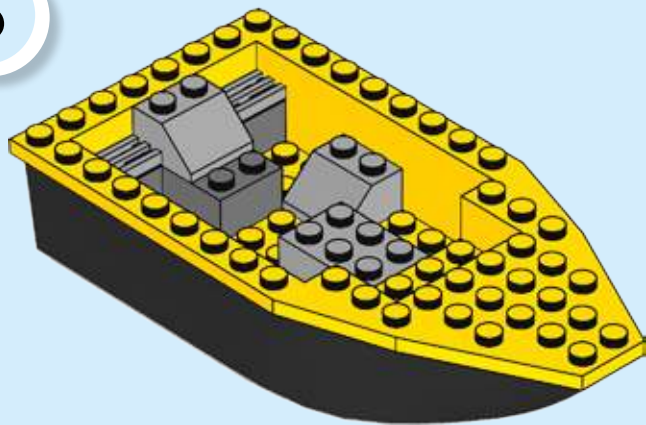

6

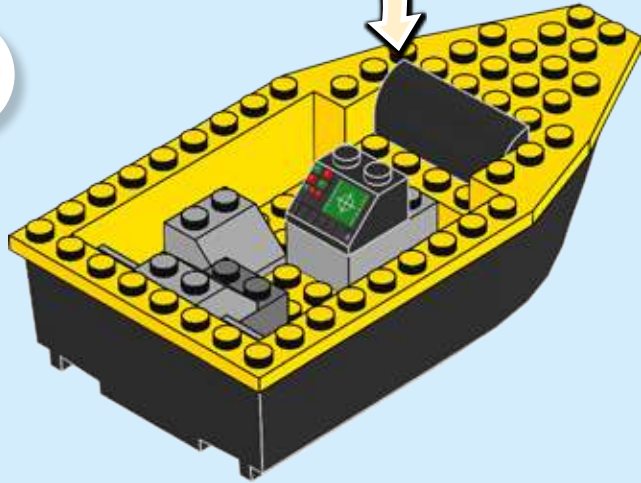
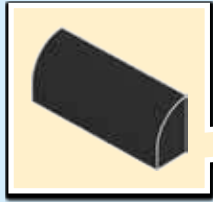



7

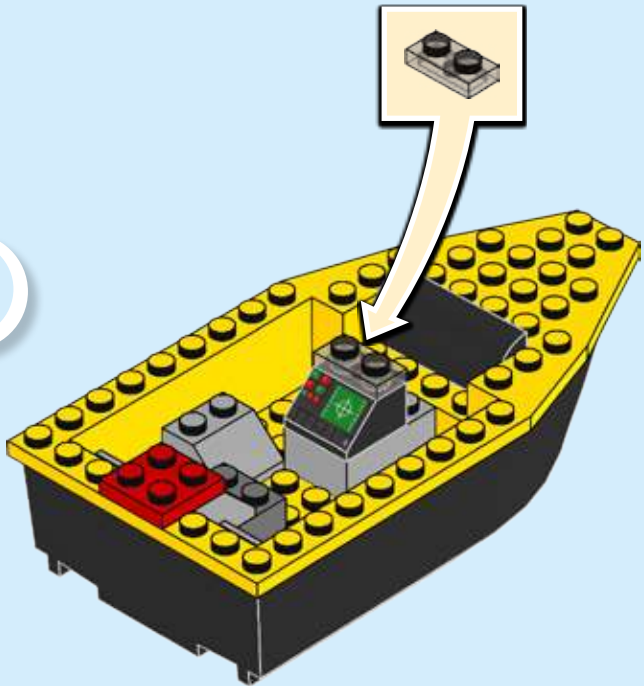

8

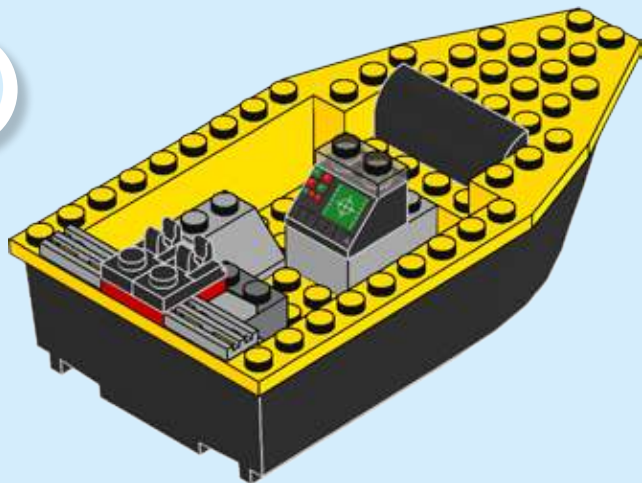

2x



2x



1x



9

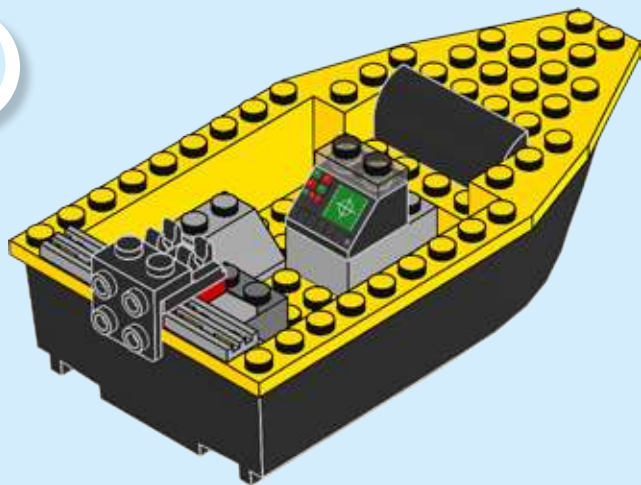

10

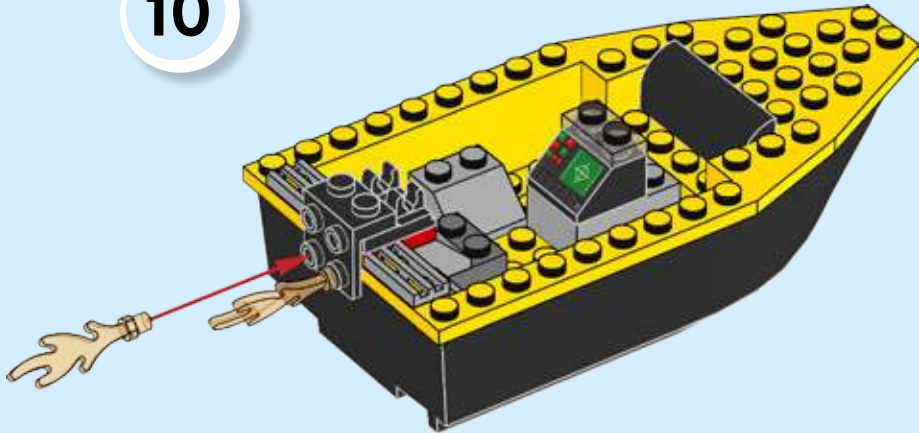

2x



2x

11

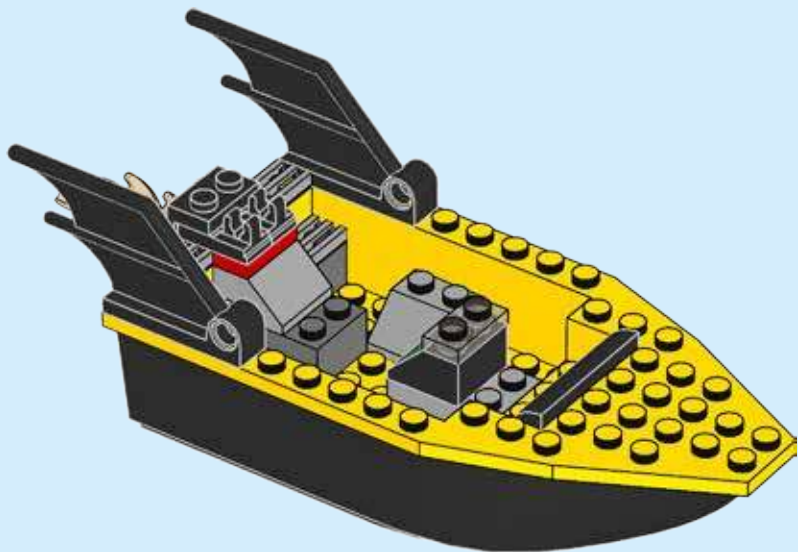

12

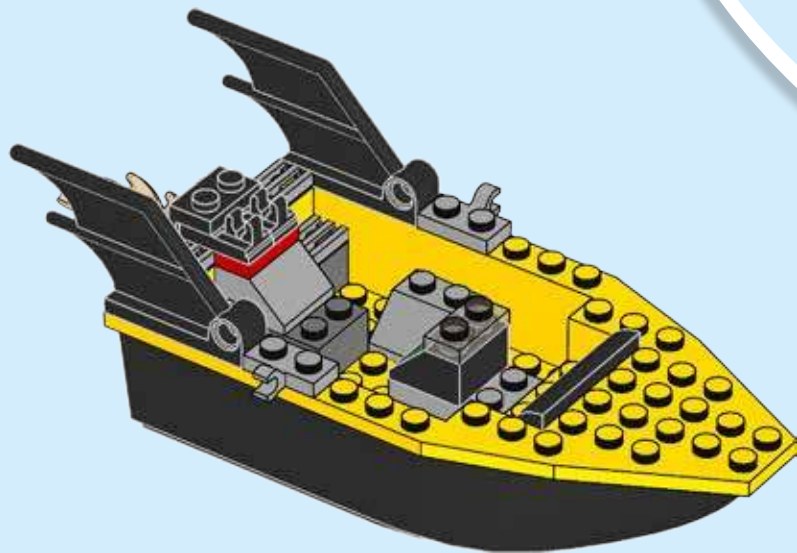

2x



1x



1x

13

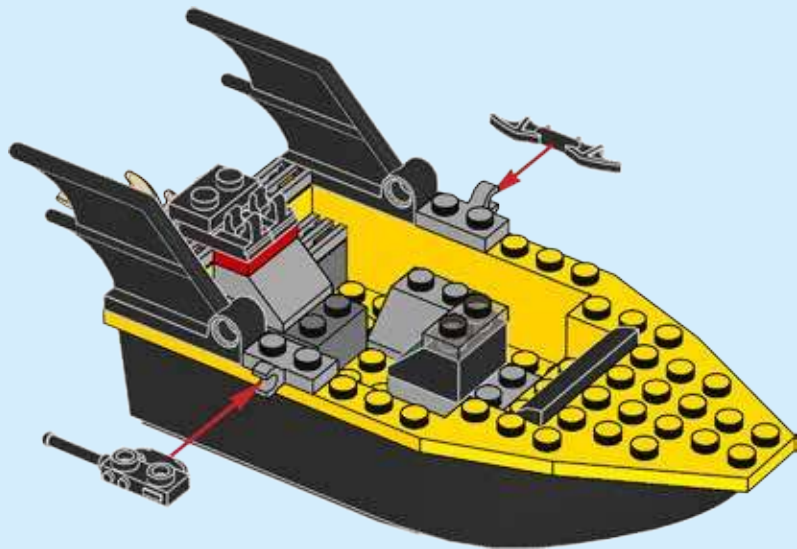

14

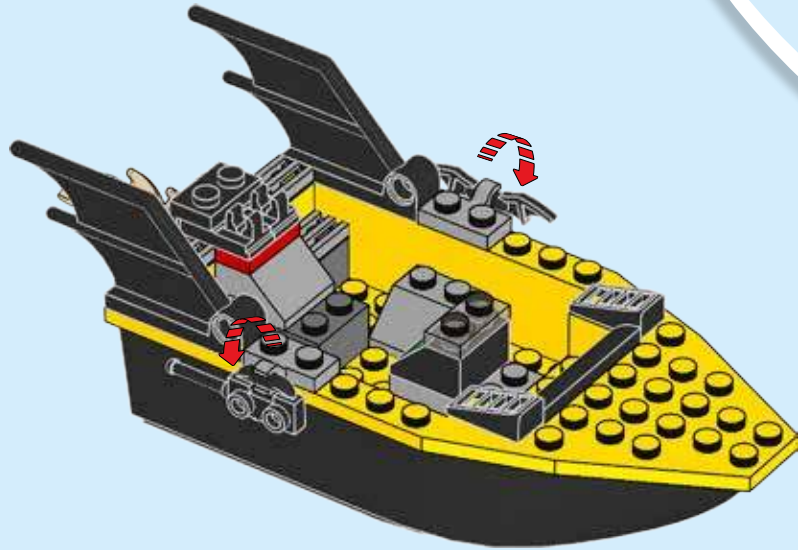



2x

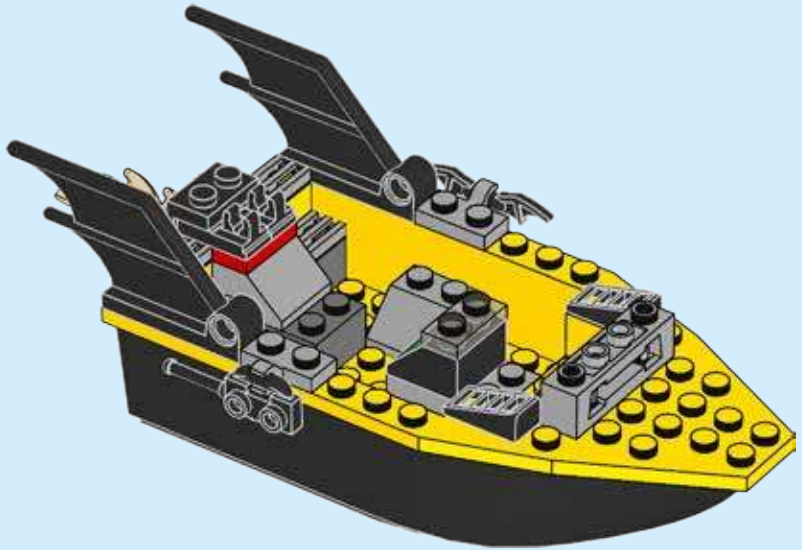

1x

15



16

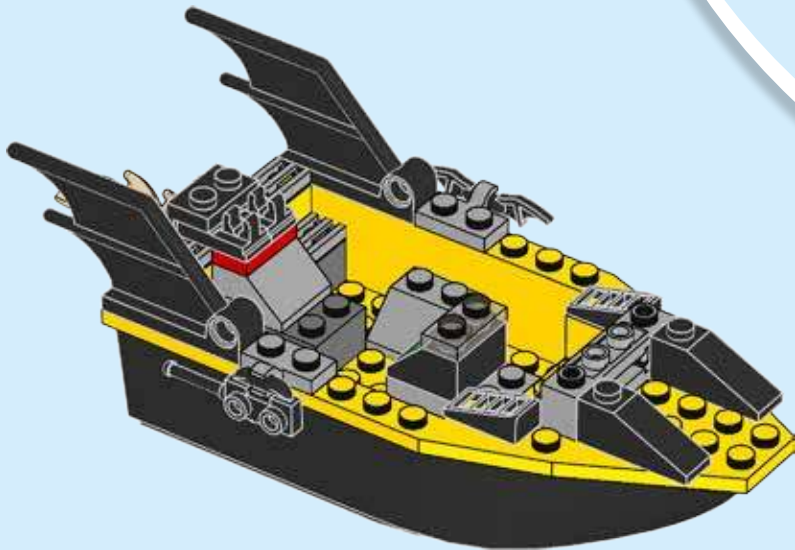

2x



1x

17

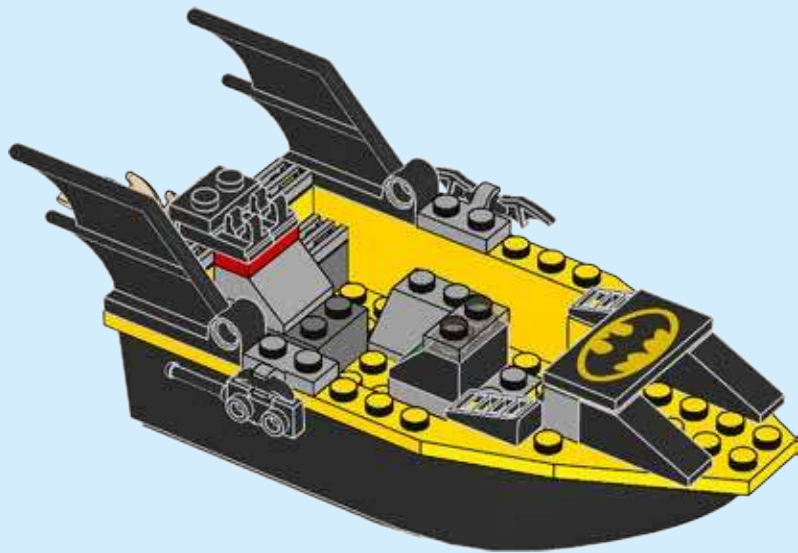

18

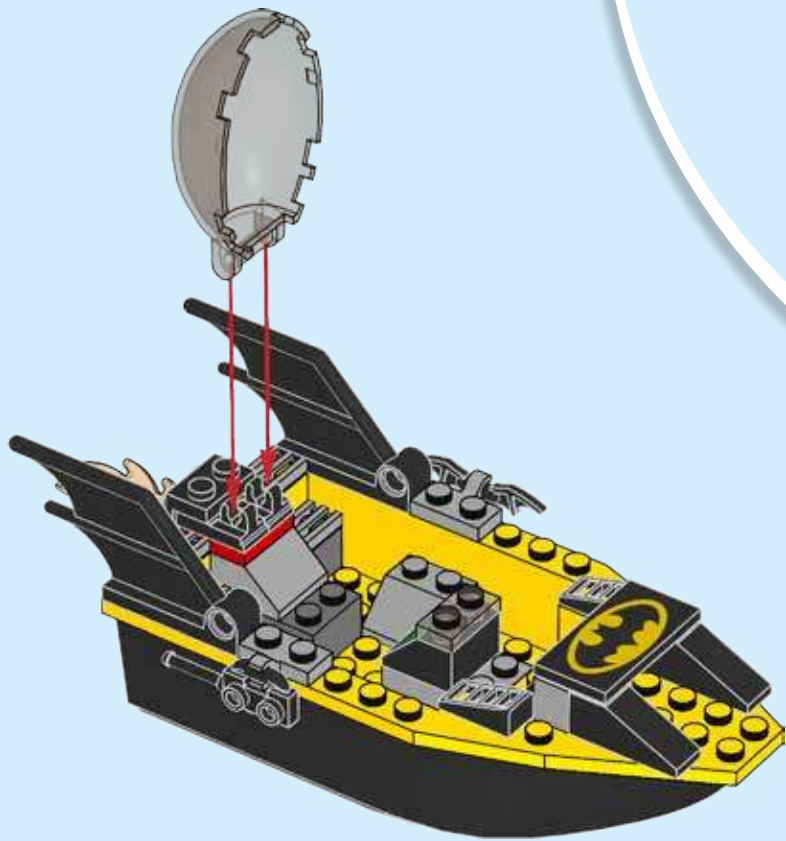



2x

19

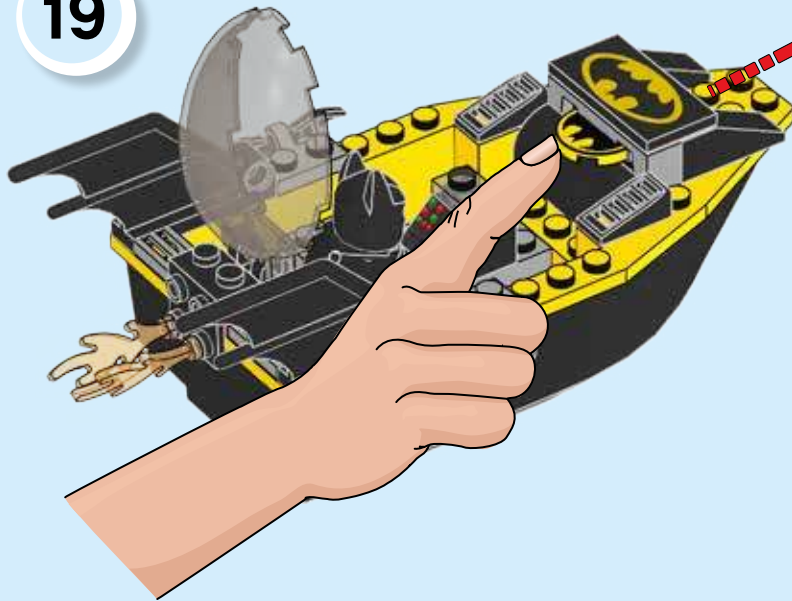

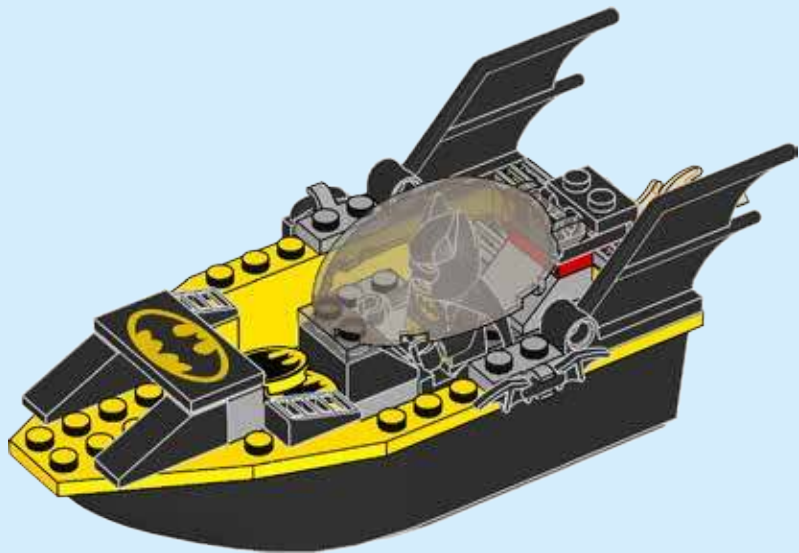
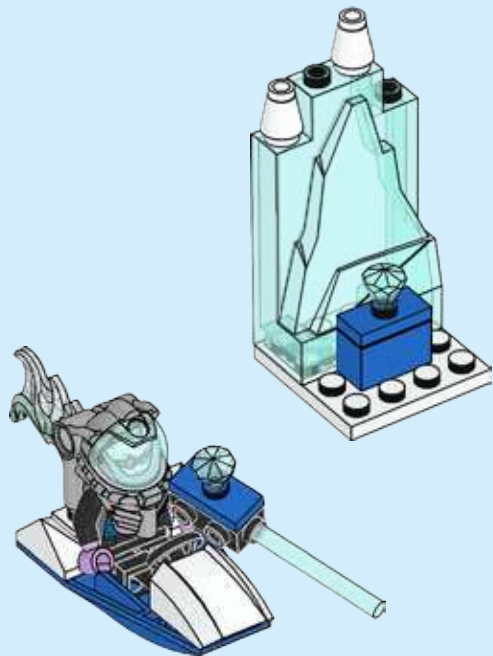



1x
6058177



2x
4518400



2x
6097801



1x
4243812



1x
6175942



1x
4195869



1x
300423



1x
6109922



2x
6092582



1x
9566



2x
6151937



1x
4295400



1x
302221



2x
428626



1x
6019726



1x
6147001



2x
4598528



1x
6117973



2x
9339



1x
6014618



1x
6174029



1x
6100054



1x
6051527



1x
4650620



1x
6125260



2x
6171909



2x
4541191



1x
6142806



1x
6033019



1x
4124073



1x
6021936



2x
4119482



1x
6001197



1x
4621774



2x
4261397



1x
4211386



3x
4211410



4x
4211350



2x
6028812



1x
6109431

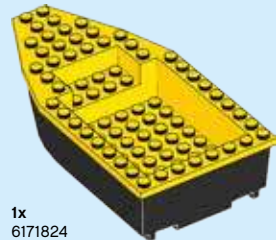

1x
6171824



1x
6096150



1x
4211060

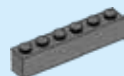

1x
4211100



1x
6175946



1x
4652294



Customer Service

Kundenservice

Service Consommateurs

Servicio Al Consumidor

LEGO.com/service or dial



00800 5346 5555 :



1-800-422-5346 :





EASY TO BUILD

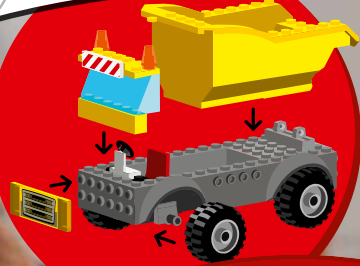

Build and play
with LEGO® Juniors

[LEGO.com/juniors](https://www.lego.com/juniors)



LEGO® Juniors
Create & Cruise



Apple and the Apple logo are trademarks of Apple Inc., registered in the U.S. and other countries. App Store is a service mark of Apple Inc.

Google Play is a trademark of Google Inc.

Ask parents' permission first.

Bitte frage erst deine Eltern um Erlaubnis.

Demande d'abord l'autorisation d'un parent.

Pide antes permiso a tus padres.

Pede primeiro permissão aos teus pais.

Először kérj engedélyt a szüleidtől!

先请求家长的许可。



LEGO® Juniors
Create & Cruise

Free app!

The fun continues!



LEGO JUNIORS
EASY TO BUILD

4-7



5-12

All DC characters and elements © & ™ DC Comics.

WIN

GO TO WWW.LEGO.COM/PRODUCTFEEDBACK AND
GIVE US YOUR SHORT **FEEDBACK** ABOUT THIS
LEGO® SET FOR A CHANCE TO WIN
A COOL LEGO PRIZE.

Terms & Conditions apply

LEGO.com/productfeedback



GEWINNE

Erzähle uns auf
www.LEGO.com/productfeedback

etwas über die Erfahrungen, die du mit
diesem LEGO® Set gemacht hast, und
sichere dir die Chance auf einen coolen
LEGO Preis!

Es gelten die Teilnahmebedingungen

GAGNE

Rends-toi sur
www.LEGO.com/productfeedback

et donne-nous quelques commentaires sur
ce produit LEGO® pour avoir une chance
de gagner un prix LEGO !

Voir Conditions Générales

GANAN

Visita
www.LEGO.com/productfeedback

y envíanos tu opinión acerca de este set
LEGO®. ¡Participarás en el sorteo de un
premio LEGO!

Términos y Condiciones aplicables

获取奖品

登录
www.LEGO.com/productfeedback

给出关于此乐高®套装的简短反馈，
就有机会获得炫酷乐高奖品

《条款及条件》适用

LEGO and the LEGO logo are trademarks of the LEGO Group. ©2017 The LEGO Group.

 BATMAN and all related characters and elements
© & ™ DC Comics and Warner Bros. Entertainment Inc.

 WB SHIELD: TM & © Warner Bros. Entertainment Inc.
(s17)

6203505