

Technical Description and Operating Instructions

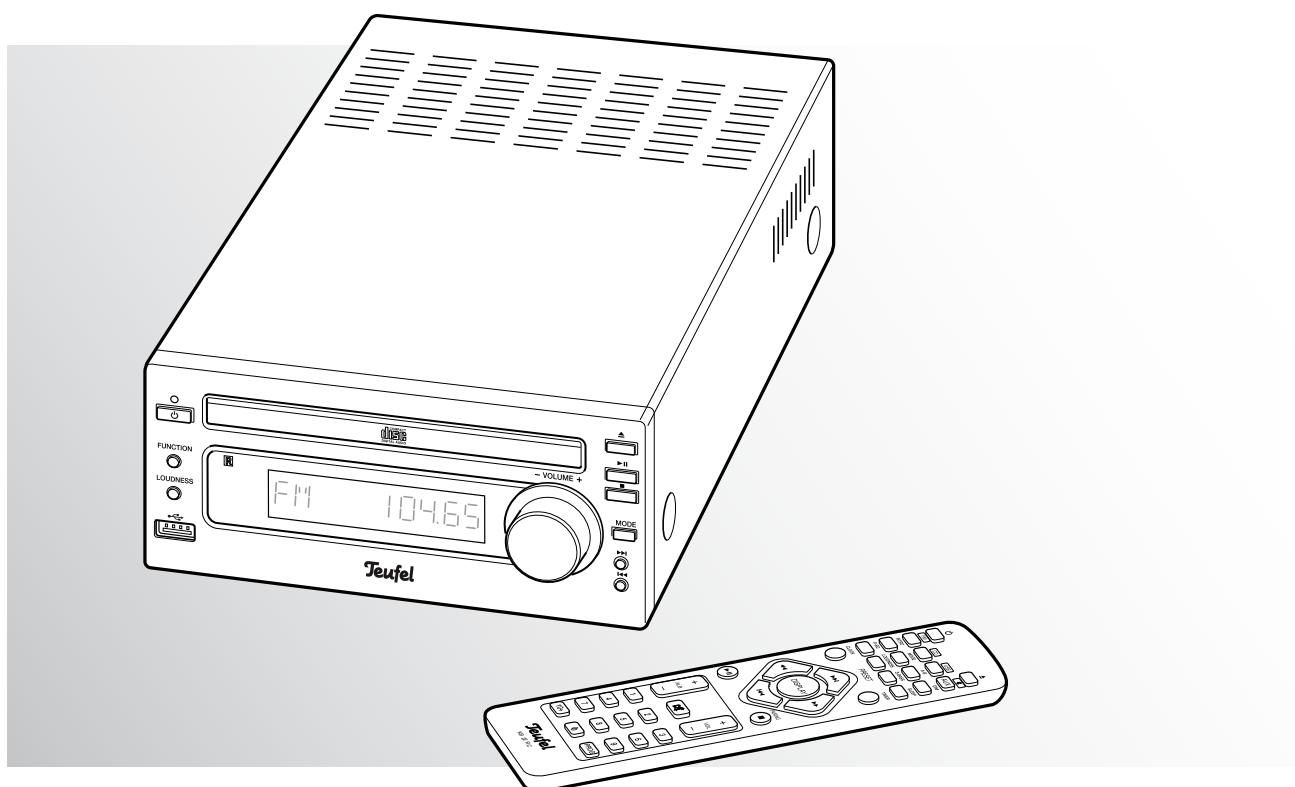

KB 22 CR

CD receiver for Kombo 22

Teufel

Contents

General notes and information	3	Radio playback	14
For your information	3	Setting the radio stations	14
Original packaging	3	Manually	14
Complaints	3	Station scanning	14
Contact	3	Mono/stereo	14
Proper use	3	Station memory	14
		Saving stations	14
Safety notes	4	Selecting stations from the memory 14	
Overview	6	CD operation	15
Control elements and connections	7	Suitable CDs	15
Setup and connection	9	About handling CDs	15
Location tips	9	Inserting a CD	15
Connecting the speakers	9	Ejecting a CD	15
Antenna	9	USB mode	16
Audio input	9	Inserting a USB stick and playback	16
Connecting to a power supply	9	Removing a USB stick	16
Remote control	10	AUX operation	17
Changing the battery	10	Analogue source device	17
Functionality	10	Bluetooth source device	17
Basic functions	11	Playback functions (CD, MP3/WMA, USB)	18
Activating and deactivating	11	Search by track number	18
Activating	11	Repeat function / Shuffle	19
Switching to Standby	11	Repeating a section	19
EcoPower mode	11	Program playback	19
Activating EcoPower mode	11	Creating a program	19
Deactivating EcoPower mode	11	Playing a program	20
Dimmer	11	Deleting a program	20
Selecting a source	12	Timer functions	20
Adjusting the volume 12		Sleep	20
Mute 12		Activating Sleep	20
Adjusting the sound	12	Deactivating Sleep	20
Equalizer	12	Displaying the Sleep time remaining	20
Aurally compensated volume	12	Timer / alarm function	21
Bass boost	12	Switching the timer /alarm function on and off 21	
Clock	13	Troubleshooting	22
Setting the time	13	Care and cleaning	22
Automatically with RDS	13	Protecting the environment	23
Manually	13	Technical data	23
Displaying the time	13		

General notes and information

Notice

The information in this document may change without prior notice and in no way constitutes any liability on the part of Lautsprecher Teufel GmbH.

No part of these instructions may be reproduced in any form or be broadcasted in any way electronically, mechanically, by photocopy or recording without the written permission of Lautsprecher Teufel GmbH.

© Lautsprecher Teufel GmbH
Version 1.0
July 2013

Original packaging

If you wish to exercise your eight-week right of return, we ask that you be absolutely sure to hold onto the packaging. We can only accept the return of the speakers WITH THE ORIGINAL PACKAGING. Empty boxes are not available!

Complaints

In case of complaint we will need the following information to process your enquiry:

1. Invoice number

Can be found on the sales slip (enclosed with the product) or on the order confirmation received as a PDF document, e.g. 4322543

2. Serial number or batch number

Located on the back of the unit,
e.g. serial number: KB20240129A-123.

Many thanks for your support!

Contact

For questions, suggestions or any other issues please contact our customer service department:

Lautsprecher Teufel GmbH
Gewerbehof Buelowbogen · Buelowstraße 66
10783 Berlin (Germany)

Phone: 00800 - 200 300 40 (toll-free)

Fax: +49 (0)30 / 300 930 930

E-mail: service@teufelaudio.com

www.teufelaudio.com

Proper use

Only use the unit as described in these operating instructions. Any other use will be deemed as not in accordance with the instructions and may lead to damage of property or even persons.

The manufacturer accepts no liability for damage caused by use not in accordance with the instructions.

The unit is intended for private use.



Before operating the speakers please read the safety notes and operating instructions carefully. This is the only way to use all functions safely and reliably.

Keep the operating instructions safe and pass them on to anyone who may own the unit after you.

Safety notes

Caution icons

You will find the following caution icons in these instructions:

Danger High risk!

Failure to observe the warning may result in severe personal injury or death.

Attention Moderate risk!

Failure to observe the warning may result in property damage.

**Minor risk!**

Points which should be observed when handling the unit.

Safety notes

Danger Risk of electric shock!

Faulty installation of electrical equipment or mains voltage which is too high can cause electric shocks.

- Only operate the unit with the mains adapter supplied or with a mains adapter of identical construction.
 - Disconnect the mains adapter immediately and do not use the unit if its case or the mains adapter are defective or if there is other visible damage.
 - If the unit emits smoke or smells of burning or other unusual odours, disconnect it immediately from the power supply and do not operate it.
 - The standby button does not disconnect the unit from the power supply. Therefore, place the unit so that the mains adapter is easily accessible.
 - Never open the case of the mains adapter or the unit. Repairs may only be carried out by an authorised specialist workshop. Only parts which conform with the original unit specifications may be used in this case. There are electrical and mechanical parts in this unit which are necessary in order to avoid exposure to sources of danger.
 - Do not insert any objects through the vent slots in the housing.
 - Only use the unit in indoor areas.
 - Do not operate the unit in damp areas and protect it from drops of water or splash water. Also take care not to stand vases or other containers filled with liquid on or near the speaker in order to avoid liquid getting into the case. If water or other foreign objects should enter the unit, immediately disconnect the mains plug. Then send the unit to our service address.
 - Never touch the mains adapter with wet hands.
 - Check the unit regularly for damage.
-

Danger Danger to children!

Children can become trapped in the packing film when playing and suffocate.

- Do not allow children to play with the unit or the packing film. Danger of suffocation.
 - Ensure that children do not remove small parts from the unit or take them off of the unit (e.g. control knobs or plug adapters). They could swallow the parts and choke.
 - Never allow children to operate electrical units unsupervised.
-

**Danger to hearing!**

Extended listening at high volumes may lead to hearing loss.

Very high acoustic pressure can suddenly be created, especially if the unit is switched on when set at full volume. This may have psychological consequences and also cause physical injury. Children and pets are particularly at risk.

- Set the volume control on your unit to a low level.
 - When the volume is set to a high level, never place your ear directly on the speaker.
 - To avoid damage to health, avoid extended listening at high volumes.
-

Danger Health hazard!

If the battery belonging to the product is swallowed, this may result in severe internal injuries and even death.

- Keep both new and used button cell batteries so that they are not accessible for children.
 - If the battery compartment can no longer be closed securely, do not use the product further and keep it so that it is not accessible for children.
 - If you suspect that a button cell battery has been swallowed or ingested in any other way, seek the immediate attention of a physician.
-

Danger Danger of chemical burns!

Leaking battery acid may lead to chemical burns.

- Do not allow battery acid to come into contact with skin, eyes or mucus membranes. In case of contact with acid rinse the affected part immediately with plenty of plain water and if necessary see a doctor.
-

Danger Danger of explosion!

Batteries (particularly lithium batteries) can explode if used improperly.

- Never attempt to recharge batteries.
 - Only use batteries of the same or equivalent type.
 - Do not heat or short circuit batteries or rechargeable batteries and do not dispose them in fire.
 - Do not expose batteries and storage batteries to direct sunlight.
-

Danger Danger of injury/damage!

Setting the unit up in an unsuitable location may result in injury to persons and/or damage

to property.

- Never use the unit unmounted in vehicles, in unstable locations, on wobbly tripods or furniture, on insufficiently dimensioned brackets etc. The unit could tip or fall down and cause injury to persons or be damaged itself.
 - Set up the unit in such a way that you cannot accidentally knock it over and that the cables do not pose any trip hazard.
 - Do not place the unit near sources of heat (e.g. heaters, ovens, other heat generating equipment such as amplifiers etc.).
-

Danger Danger to eyes and skin!

Opening the disc compartment with the lock deactivated will cause an invisible or visible laser beam to be emitted.

- Do not look into the beam, even if you are using optical instruments.
-

Attention Fire hazard!

Improper use may lead to damage or fire.

- Do not place open flames such as burning candles or similar on the unit.
 - Do not place the unit in direct sunlight.
 - Ensure sufficient ventilation.
 - Do not cover the vents with curtains, blankets, newspapers or similar. Heat build-up inside the unit can shorten its lifetime.
-

Attention Risk of damage!

External influences may damage or destroy the device.

- If the unit is to be left unsupervised for a long period (e.g. during a holiday), or if a thunderstorm is forecast, disconnect the power plug from the mains power supply. Otherwise, a sudden overvoltage may cause a defect.
 - Leaked batteries may damage the remote control. In case of prolonged absence, remove any batteries from the remote control.
 - If the device is subjected to warm temperatures after being cold (e.g. after transport), condensation may occur inside of it.
In this case, wait at least 2 hours before you connect and activate it.
-

Explanation of symbols

	Safety category II Dual insulation
	May only be used indoors.
	Polarity on the round connector: outside (-), inside (+)

Overview

Product contents

- ① 1 x CD receiver KB 22 CR
- ② 1 x remote control
- ③ 1 x mains adapter
- ④ 1 x throw-out aerial for VHF (FM)
- ⑤ 2 x speaker cable

The speakers for this system are supplied in a separate packaging. Please take note of the instructions supplied with the speakers.

Checking the product contents

- Check that all items have been delivered and that nothing is damaged.
- If the delivery is incomplete or you find damage sustained in transit, do not operate the unit but contact our service department (see page 3).

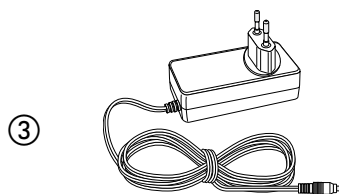
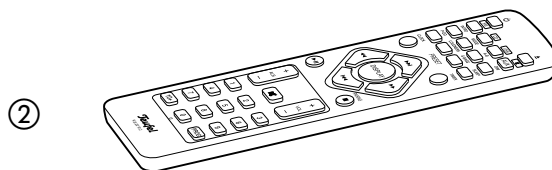
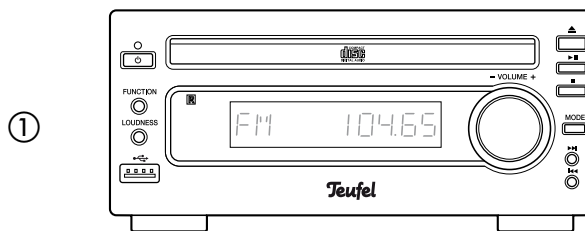

Control elements and connections

Front side

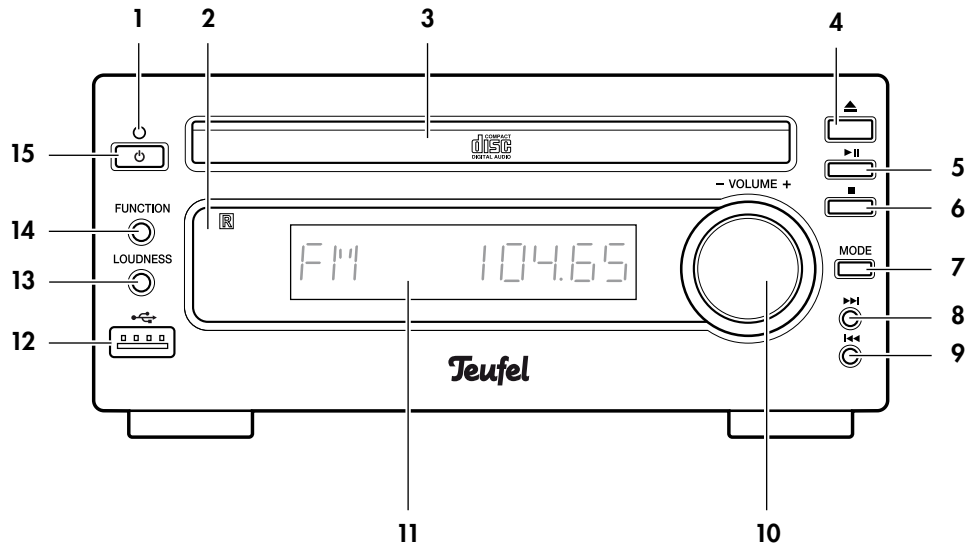

Item	Name	Description
1	—	Control LED
2	—	Infrared receiver for remote control
3	—	CD drawer
4	▲	Opening / closing the CD drawer
5	▶	Playback/pause
6	■	Stop button
7	MODE	Radio operation: Switch between stereo/mono USB and CD: Adjust repeat
8	▶▶	Radio operation: Select stored station (up) USB and CD: Next track

Item	Name	Description
9	◀◀	Radio operation: Select stored station (down) USB and CD: Previous track
10	VOLUME	Volume control
11	—	DISPLAY
12	🔌	USB connection
13	LOUDNESS	Switch aurally compensated volume on / off
14	FUNCTION	Switch signal source
15	🔌	Switch unit on or to Standby / EcoPower mode

Back side

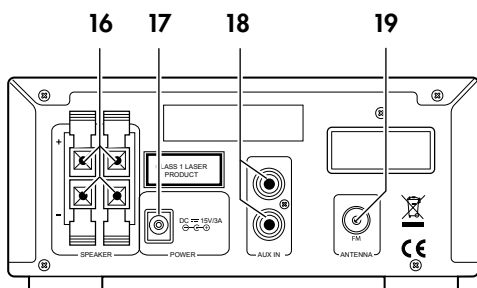

Item	Name	Description
16	SPEAKERS	Speaker connections
17	—	Mains adapter connection
18	AUX IN	External signal source connection
19	FM	FM / VHF antenna connection

Remote control

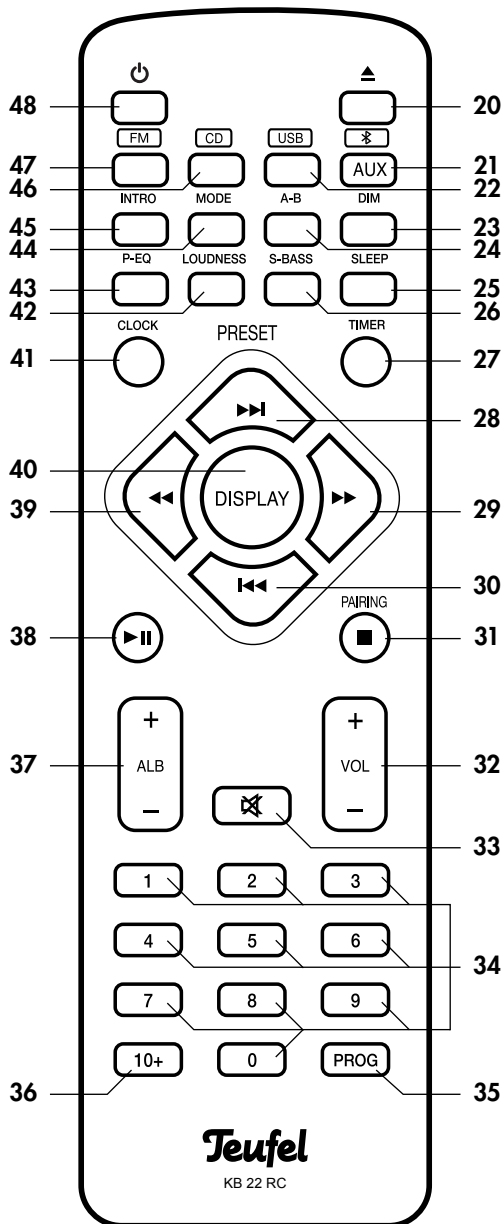

Item	Name	Description
20	▲	Open / close the CD drawer
21	AUX	Select external source device (AUX / BT)
22	USB	USB input selection
23	DIM	Change the brightness of the display
24	A-B	CD and USB only: Repeat a section
25	SLEEP	Switch-off function
26	S-BASS	Switch Super-Bass on / off
27	TIMER	Switch-on function
28	▶▶	Radio operation: Select stored programme (upwards) CD and USB: Next track
29	▶▶	Radio operation: Frequency up
30	◀◀	CD and USB: Fast forward Radio operation: Select stored programme (downwards) USB and CD: Previous track
31	■ / PAIRING	Stop button / disconnect blue-tooth connection
32	Vol +/-	Volume adjust
33	MUTE	Mute speaker
34	1 ... 0	Number buttons
35	PROG	Radio operation: Store station USB and CD: Set program play-back
36	10+	Select track or stored station >10
37	ALB +/-	Radio operation: Next/previous stored station CD and USB operation: Select next/previous album
38	▶	Playback/pause
39	◀◀	Radio operation: Frequency down CD and USB: Rewind
40	DISPLAY	Radio operation: Show RDS info USB and CD: Show track info
41	CLOCK	Show time
42	LOUDNESS	Switch aurally compensated volume on/off
43	P-EQ	Adjust the sound
44	MODE	Radio operation: Switch between stereo/mono CD and USB: Set repeat /shuffle mode
45	INTRO	CD and USB: Play track sample
46	CD	CD operation
47	FM	Radio operation
48	⏻	Switch unit on or to Standby / EcoPower mode

Setup and connection

Location tips

- Select a stable, level base.
- Make sure that the environment is clean and free from dust.
- Avoid placing the unit close to sources of heat or in direct sunlight.
- Arrange the connector cables so that they do not pose a trip hazard.
- Do not place heavy objects on the cables or unit.

Connecting the speakers

Use the speaker cables supplied to connect the speakers. If you need longer cables you can order them from the "Accessories" section of our online shop (www.teufel.de).

On the back side of the CD receiver are the "SPEAKER" connecting terminals 16 for the right ("R") and left ("L") speakers.

The terminals are each marked red (+) and black (-).



Make sure the polarity is correct!

Connect the like coloured terminals. Otherwise the sound quality will suffer. The strands of the speaker cables are marked with different colours or shapes.

1. Split the wire down by approx. 30 mm on both ends and remove approx. 10 mm of insulation each. Twist the wire so that no strands are protruding. Tin coating is not necessary.

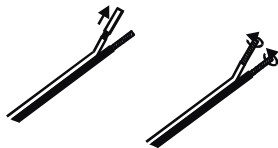

2. Flip the lever on the connecting terminal up or down to open the terminal.

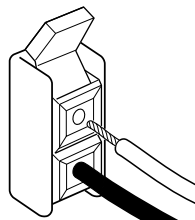

3. Guide the exposed end of the cable into the opening in the terminal and close the lever again. The cable has now been clamped in place.

Antenna

Danger



Risk associated with lightning strike!

If you are using outdoor or roof antennas, be absolutely sure that the antenna has lightning protection.

To receive FM/VHF stations, connect the antenna to the jack 19 "FM". This may be a roof/outside antenna, but also a cable television connection. You will need a coaxial connector cable for this.

If there is no antenna connection available where the unit is located you can use the throw-out aerial 4 supplied. Push the aerial plug into the jack 19 "FM" and adjust the position of the throw-out aerial for best reception. Now fixed the antenna in place with tape.

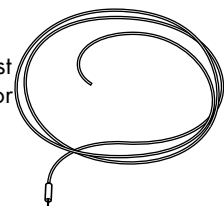

Audio input

You can connect almost any audio source to the "AUX IN" cinch jacks 18 on the back of the unit, i.e. computer, Smartphone, MP3 player (with/without dock), games console, television etc. The source device must have an output with line level. This kind of output is either a stereo cinch jack or a 3.5 mm jack plug. **Connect these units to the "AUX IN" connections 18** using appropriate cables. Cables are available from our online shop (www.teufel.de) in the "Accessories" section.

Connecting to a power supply

Connect the round plug on the mains adapter supplied to connection 17 on the back of the unit. Connect the mains adapter to a mains power socket.

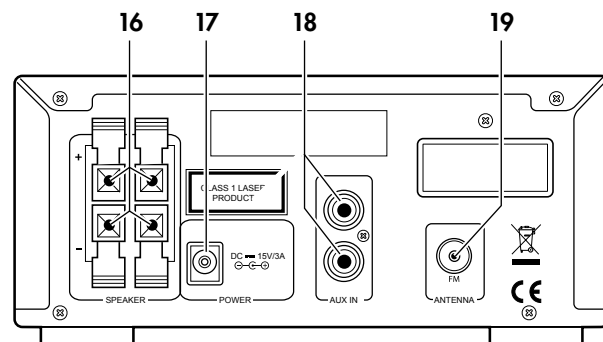

Remote control

A 3 Volt button battery CR2025 is required to operate the remote control.

The battery is already installed in the remote control unit on shipping and is protected by a strip of plastic. You will see this plastic strip on the back of the remote control. Simply remove it with care. The remote control is now ready for use.

Danger Health hazard!

If the battery belonging to the product is swallowed, this may result in severe internal injuries and even death.

- Keep both new and used button cell batteries so that they are not accessible for children.
- If the battery compartment can no longer be closed securely, do not use the product further and keep it so that it is not accessible for children.
- If you suspect that a button cell battery has been swallowed or ingested in any other way, seek the immediate attention of a physician.

Danger Danger of chemical burns!

Leaking battery acid may lead to chemical burns.

- Do not allow battery acid to come into contact with skin, eyes or mucus membranes. In case of contact with acid rinse the affected part immediately with plenty of plain water and if necessary see a doctor.

Danger Danger of explosion!

Batteries (particularly lithium batteries) can explode if used improperly.

- Never attempt to recharge batteries.
 - Only use batteries of the same or equivalent type.
 - Do not heat or short circuit batteries or rechargeable batteries and do not dispose them in fire.
 - Do not expose batteries and storage batteries to direct sunlight.
-

Changing the battery

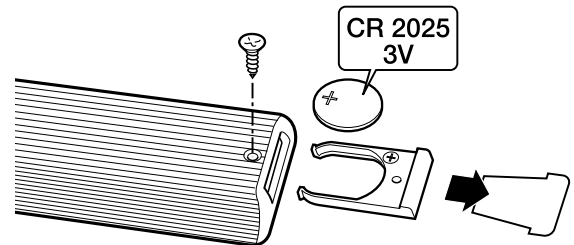

1. Hold the remote control face down.
2. Unscrew the cross-headed screw using a screwdriver.
3. Pull the battery compartment out of the remote control.
4. Take out the old battery (see „Batteries and rechargeable batteries“ on page 23).
5. Place the new battery into the holder, making sure that the “+” symbol is visible on the battery and on the holder.
6. Replace holder and push the compartment back in until it clicks.
7. Screw-tighten the cross-headed screw.

Functionality

The remote control relays the control signals by means of infrared light. It is therefore important that you point the remote control in the direction of the unit. Make sure that the infrared light is not obstructed by objects.

Fluorescent or energy-saving light bulbs installed in the facility of the unit may impair the function of the remote control or even make it impossible.

Basic functions

Activating and deactivating

Activating

- Press button **15** or **48** "⏻" or one of the function select buttons **21** "FM", **22** "CD", **46** "USB" or **47** "AUX". The unit powers up, the display briefly shows "HELLO".

Switching to standby

- During operation press button **15** or button **48** "⏻" briefly. The unit will switch to Standby. The display briefly shows "BYE BYE", and then displays the time. After a few minutes the time display disappears and the display goes dark.
- In order to show the time again, press button **41** "CLOCK" briefly.

EcoPower mode

In EcoPower mode the unit uses a maximum of only 0.5 Watt.

Activating EcoPower mode

- Whilst in operation or when in standby, press and hold button **15** or button **48** "⏻" for approx. 3 seconds. The display briefly shows "ECOPOWER", then goes dark. EcoPower mode is now switched on and replaces Standby mode. This means that pressing button **15** or button **48** "⏻" will no longer switch the unit to Standby but to EcoPower mode.

Switching from EcoPower mode

- Whilst the unit is in EcoPower mode, press and hold button **15** or button **48** "⏻" for approx. 3 seconds. The display shows the time, the unit is now back in standby. EcoPower mode is now switched off. This means that pressing button **15** or button **48** "⏻" will no longer switch the unit to EcoPower mode but to standby.

Dimmer

- You **23** "DIM" to control the brightness of the display. The display brightness is adjusted every time you push the button: bright, medium, dim.

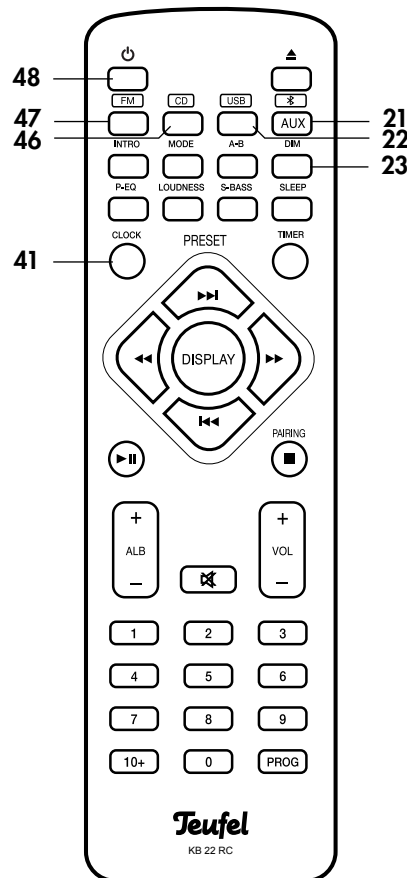
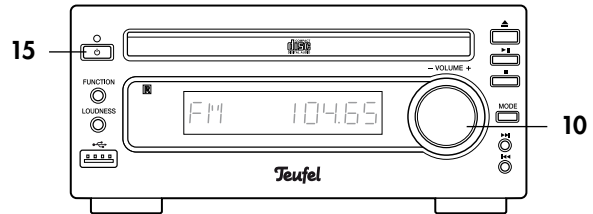

Selecting a source

When the unit is switched on the recently selected audio source is activated.

Use button **14** "FUNCTION" to change the source, or select a source directly using the buttons

- **47** "FM" (Radio)
- **46** "CD" (CD player)
- **22** "USB" (USB storage)
- **21** "AUX"/"⌘" (external signal source, line or Bluetooth)

The display will now show the selected source.

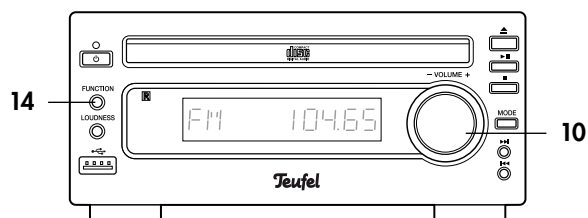

Adjusting the volume

- Use control **10** "VOLUME" or button **32** "Vol" to set the desired volume level.

The display will show the volume level selected from Min to Max.

Mute

- Use button **33** to mute the sound. The display shows the flashing message "MUTING".
- To turn the sound back on: Press button **33** again or adjust the volume.

Adjusting the sound

Equalizer

Press button **43** "P-EQ" to sequence through the preset sound patterns and select: FLAT (sound unchanged), POP, JAZZ, CLASSIC and ROCK.

Aurally compensated volume

Pressing button **42** "LOUDNESS" switches the aurally compensated volume control on and off. When this function is switched on, the symbol is shown in the display and when playback is quiet the sound will be fuller.

Bass boost

Pressing button **26** "S-BASS" switches the bass boost function on and off; this boosts the deeper tones and slightly boosts the higher tones too. When the S-BASS function is switched on the symbol appears in the display.

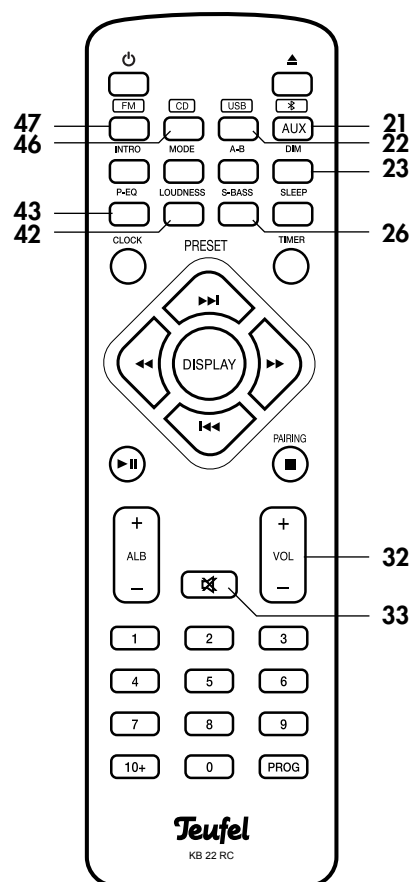

Clock

The integrated clock shows the current time in the display. The clock is set manually or by RDS when in radio mode. There is also a sleep function (up to 90 minutes).

Setting the time

Automatically with RDS

Select a radio station with RDS signal (see „Setting the radio stations“ on page 14). After a few minutes the KB 22 CR will pick up the time signal from the radio station and set the clock accordingly.

Manually

If no RDS station is being received, you can also set the clock manually:

1. Switch the unit to standby using button **15** or button **48** “**⏻**”.
2. Press button **41** “CLOCK” briefly once. The display will show the current time.
3. Press button **41** “CLOCK” and hold for 3 seconds. The display will briefly show the message “CLOCK SET” and then “CLOCK 24” or “CLOCK 12”.
4. Set the clock to 24 hour or 12 hour operation using volume control **10** “VOLUME” or button **32** “Vol +/-”.
5. Press button **41** “CLOCK” briefly once. The display will flash the hour.
6. Use volume control **10** “VOLUME” or button **32** “Vol +/-” to set the hour.
7. Press button **41** “CLOCK” briefly once. The display will now flash the minutes.
8. Use volume control **10** “VOLUME” or button **32** “Vol +/-” to set the minutes.
9. Press button **41** “CLOCK” briefly once. The time is now set.

Displaying the time

In order to show the time, press button 41 “CLOCK” briefly. The display now shows the time for 3 or 90 seconds (in standby and in EcoPower mode).

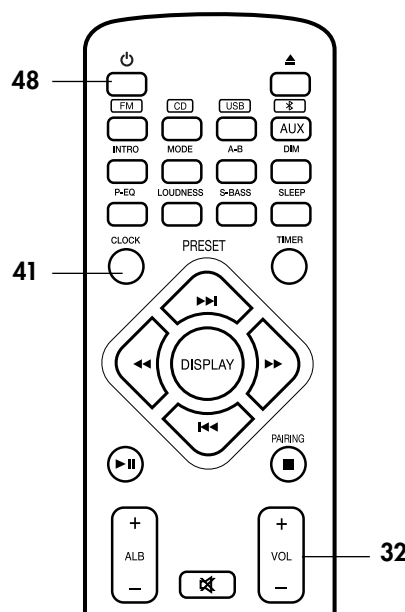
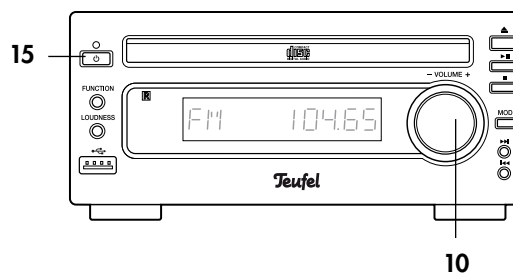

Radio playback

Use button **47** to select "Radio" as the source. Your KB 22 CR can receive mono and stereo stations in the range from 87.5 to 108 MHz.

For stations with RDS the name of the station is shown in the display and you can use button **40** "Display" to call up the programme type and the time (not all stations offer this service).

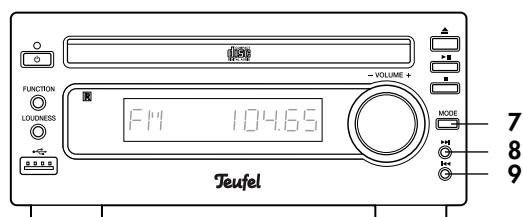

Setting the radio stations

Use button **29** "▶▶" or **39** "◀◀" to set the tuning frequency.

Manually

- Press the button briefly.
The frequency is increased or reduced by one step (0.05 MHz).

Station scanning

- Press and hold the button for approx. 3 seconds.
The search begins and will stop at the first station received with sufficient signal.

Mono/stereo

Poor signal quality may lead to sound distortion in stereo operation. Use button **7** or **44** "Mode" to switch to mono operation.

Station memory

Your radio can save 20 stations. You can then easily select saved stations at the touch of a button.

Saving stations

1. Set the desired station as described above.
2. Press button **35** "PROG". The display will flash "PROG".
3. Use button **28** "▶▶" / **30** "◀◀" to select the desired slot number for the station, or enter using the number buttons **34** "1...0". Enter the tens using button **36** "10+".
4. Press button **35** "PROG". The station has now been stored.

Selecting stations from the memory

1. Increase or decrease the slot number using button **8/28** "▶▶" or **9/30** "◀◀".
2. Enter the desired slot number using the number buttons **34** "1...0". Enter the tens using button **36** "10+".

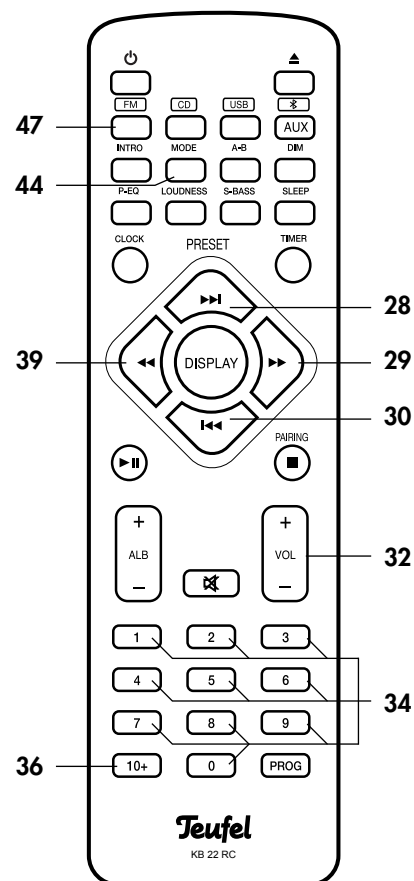

CD operation

Suitable CDs

- Use only ordinary CDs with a diameter of 120 or 80 mm bearing one of the symbols shown here.
- CDs containing MP3 and WMA files can also be read.
- CDs/CDRs, CDRWs burnt on a home system can normally be read but high burn speed or "bad" blank discs can cause problems. The only solution is trial and error in this case.
- CDs produced for commercial purposes cannot always be read.

COMPACT
disc
DIGITAL AUDIO

COMPACT
disc
RECORDABLE

COMPACT
disc
ReWritable

About handling CDs

Every CD is covered by a resistant plastic layer which protects it from outside influences. However, you must always protect the disc against dirt and scratches. CD players can compensate for minor damage to the CD. Larger scratches or other damage may result in "hanging" or similar errors. For more information about the correct handling of CDs see the notes on the CD sleeve.

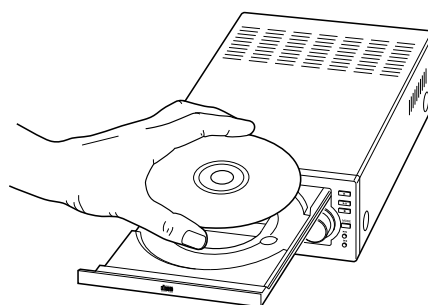

Inserting a CD

Attention Risk of damage!



Do not insert CDs on top of one another. Do not insert anything other objects than CDs.

1. Select source "CD" (see page 11).
2. Press button **4** or **20** "▲". The CD drawer will slide out forwards.
3. Insert the CD carefully into the depression inside the CD drawer with the printed side facing up.
4. Press button **4** or **20** "▲", or button **5** or **38** "▶▶". The CD drawer will close and the unit will read the CD. The display will show the message "READ" and after a few seconds playback begins automatically.

The playback functions for CD and USB are identical and are described in the section "Playback functions" on page 16.

Ejecting a CD

- Stop playback by pressing button **6** or **31** "■".
- Press button **4** or **20** "▲". The CD drawer will slide out forwards.
- Take the CD out of the CD drawer and press button **4** or **20** "▲" to close the CD drawer.

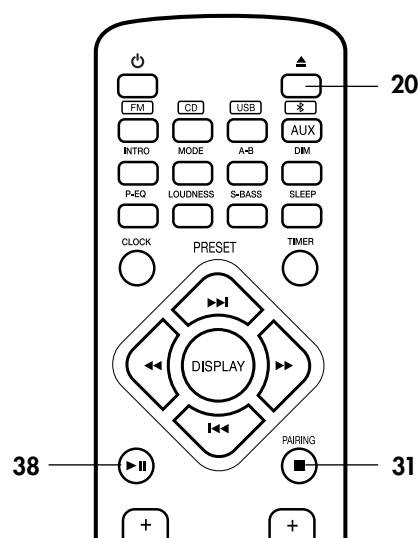
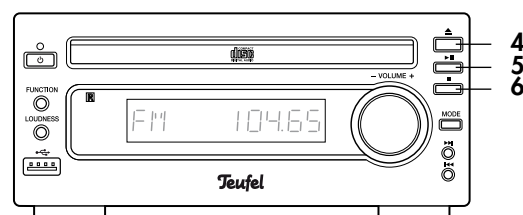

USB mode

Your new CD receiver can read USB storage devices of the specification USB 1.0 and 2.0 containing up to 32 GB of information and playback music files stored on them in MP3 and WMA formats.



Important

Do not use any storage devices with mechanical **damage** or which have fallen in liquid. Do not expose such storage devices to direct **sunlight**. Improper handling may result in **data loss**! Make backup copies of your music on your PC.

Inserting a USB stick and playback

- Use button **22** to select "USB" as the source. The display will show the message "READ USB".
- Insert the USB stick into the jack **12** "🔌". The plug only fits the jack in one position.
- If there are any music files on the stick playback will start automatically.
- If no readable files are found on the stick the display will remain dark.

The playback functions for CD and USB are identical and are described in the section "Playback functions" on page 16.

Removing a USB stick

Attention Risk of damage!



Never remove a USB storage device when your KB 22 CR is still accessing its data, i.e. during playback or pause! Stop playback using button **6** or **31** "■" before removing the device.

- Simply pull the USB stick out.

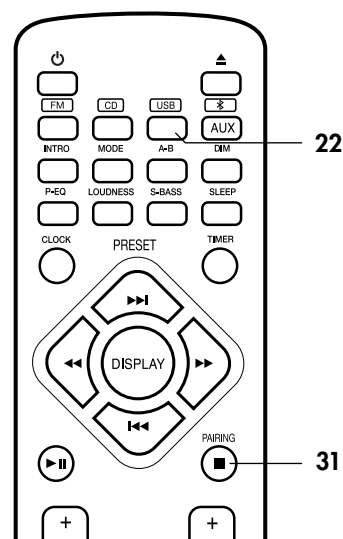
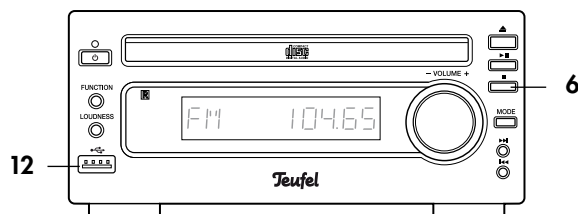

AUX operation

Analogue source device

You can connect a source device with analogue sound output using the "AUX IN" cinch jacks **18** e.g. the ear-phone output of an MP3 player or Smartphone. To do this you will need a stereo cinch cable.

- Press button **21** "AUX".
The display will show "AUX" or "BT". Press the button again if required to switch between "AUX" and "BT".

Bluetooth source device

Using Bluetooth you can connect a compatible source device to the KB 22 CR without any cables. The range is approx. 10 m.

1. Select the source "BT" using button **21**.
Press the button several times if required until "BT" appears in the display.
2. Switch on the Bluetooth function on your source device (e.g. Smartphone) and have it search for Bluetooth devices. You will find more information about this in the operating instructions of your source device.
3. Once the search is complete the list of devices found should include "Kombo 22". Select this unit to establish the connection.
4. If required, enter the password "0000".
Your KB 22 CR is now paired and will work just like Bluetooth headphones. All sounds normally reproduced by your source device will now be directed to the KB 22 CR and played via this unit.
5. If the source device is a Smartphone, the Bluetooth connection will be interrupted by any incoming calls and you can use the phone as normal.
After finishing your phone call, the sounds will once again be diverted and played back by your KB 22 CR.
6. To terminate the Bluetooth connection press button **31** "PAIRING" and hold down until the message "CLEAR" appears in the display.
Alternatively you can switch off the Bluetooth function on your source device.

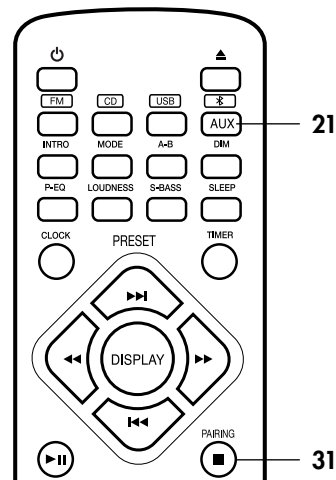
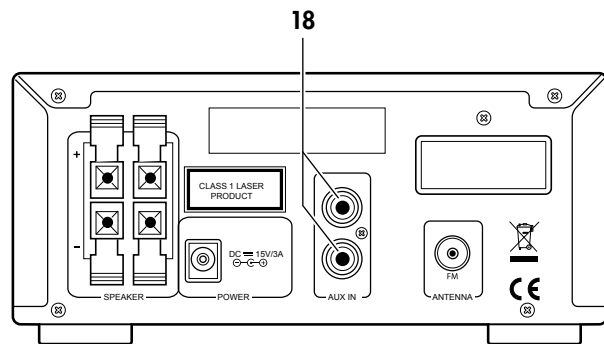

Playback functions (CD, MP3/WMA, USB)

During playback the display will show the album number (file folder, only with MP3/WMA) with two digits, the number of the current track and the playback time elapsed.

Use button **40** "DISPLAY" to display more information such as time remaining, track name, artist and album. A lot of information however is only available with MP3/WMA files or not at all.

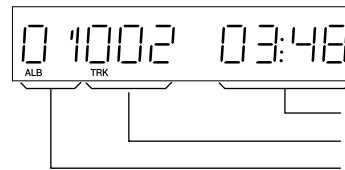

Time elapsed (3:48)
Track number (002)
Album number (01)
(only with MP3/WMA)

- Pause playback: Press button **5** or **38** "▶||"
- Continue playback: Press button **5** or **38** "▶||" again.
- Play next track: Tap button **8** or **28** "▶▶"
- Play previous track: Tap button **9** or **30** "◀◀" twice.
- Fast track playback: Press and hold button **39** "◀◀" or **29** "▶▶"
. Playback occurs without sound; you will see the elapsed play time of the track in the display.
To resume normal playback release the button.
- Only with MP3/WMA:
 - Select next album (next file folder): Tap the top "+" of button **37** "ALB".
 - Jump to the start of the album or to the previous album: Tap the bottom "-" of button **37** "ALB" several times if required.
- Press "INTRO" button **45** for the sample playback function. Only the first 10 seconds of each track will be played.
Switch function off: Press "INTRO" button **45** again.
- Stop playback: Press button **6** "■" or **31** "■".

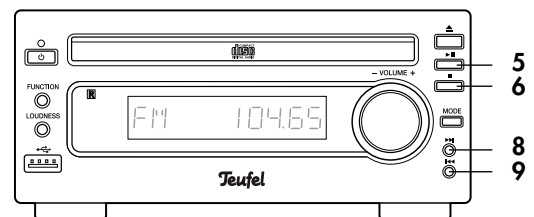

Search by track number

The KB 22 CR numbers each track of a CD or USB stick sequentially even if they are saved in different folders. Enter the desired number using the number buttons **34** "1 ... 0" and, for the tens, using button **36** "10+". Playback will start.

Repeat function / Shuffle

Use button **7** or **44** "MODE" to switch between repeat functions; you will see the function selected in the display:

- **TRK REP** (flashing) – repeat the current track.
- **REP ALB** (flashing, only with MP3/WMA) – repeat all

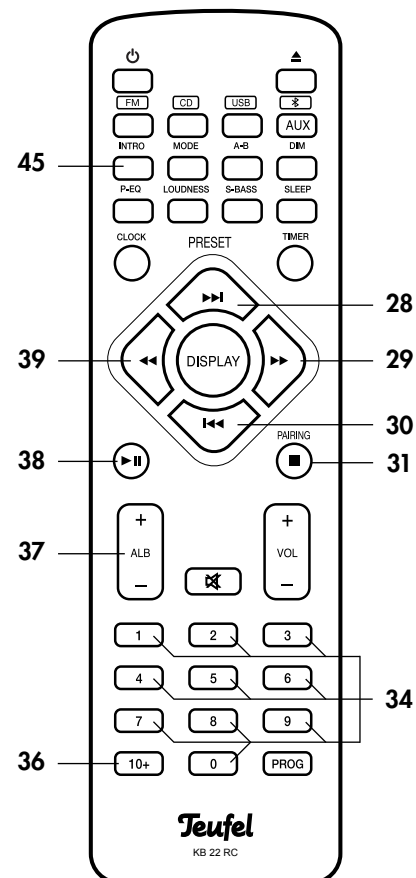

tracks of the current album (file folder).

- **REP ALL** – play all tracks and then start again from the beginning.
- **SHUF** (shuffle) – play all tracks in random order.

Repeating a section

This function allows you to define a section to be repeated.

1. Start playback.
2. At the start of the desired section press button **24** "A-B" briefly.
3. At the end of the desired section press button **24** "A-B" briefly again.
The section will now be continuously repeated.
4. To resume normal playback press button **24** "A-B" briefly again.

Program playback

You can program up to 20 tracks to be played in an order set by you. You can enter a title or titles several times into the program if desired.

Creating a program

Do not press the stop button **6** "■" or **31** "■" whilst programming as this will delete the program.

1. Press button **35** "PROG".
The number of the program slot ("P-00") will appear on the right of the display and the message "PROG" will be flashing.
2. Set the first track number:
 - Enter using button **36** "10+" for the tens and the number buttons **34** "1 ... 0", or
 - Select the album using button **37** "ALB" (MP3/WMA only) and then select the track number using button **8** or **28** "▶▶" and **9** or **30** "◀◀".
3. Press button **35** "PROG".
The number of the next program slot (e.g. "P-01") will appear briefly on the left of the display.
4. Enter all desired tracks in the same way.

Playing a program

- After entering the last track start the program using button **5** or **38** "▶||".
All programmed tracks will be played in the programmed order. The display will show "PROG".
- To stop program playback press button **6** "■" or **31** "■" once briefly – the program remains in the memory.

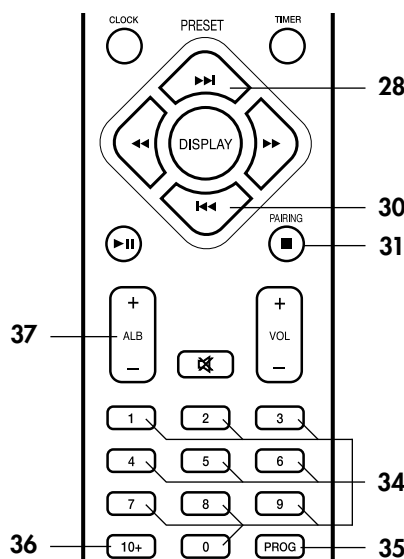
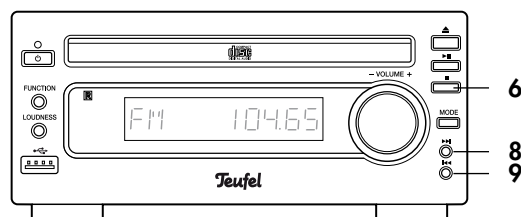
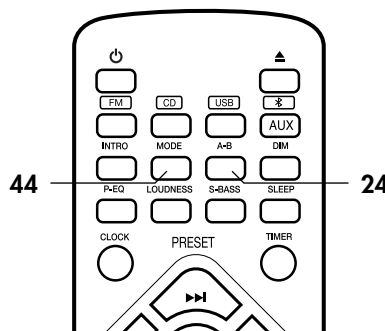
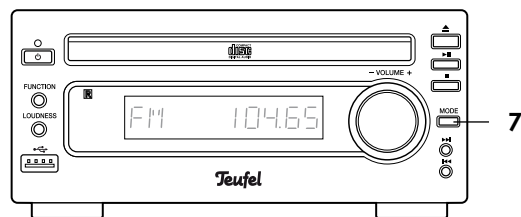

Deleting a program

- Press button **6** "■" or **31** "■" twice during programmed playback or once in stop mode

The display will show the message "PROGRAM CLEARED".

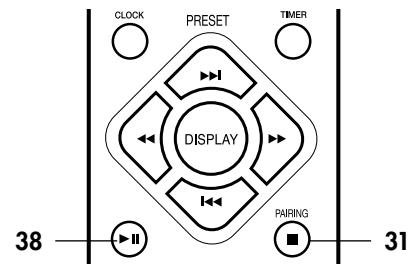
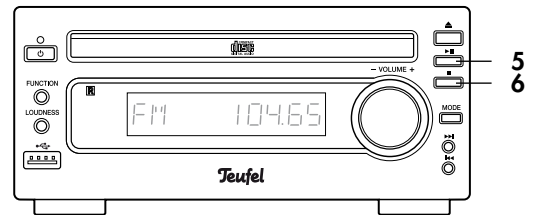

Timer functions

Sleep

This function allows the KB 22 CR to switch itself off after a preset period of time.

Activating Sleep

- During playback press button **25** "SLEEP".
"SLEEP OFF" will appear in the display.
- Press button **25** "SLEEP" again to set the number of minutes till switch-off: 120, 90, 60, 45, 30 or 15 minutes.
A short time after pressing the last button the original display will reappear and the countdown begins.

Deactivating Sleep

- Press the "SLEEP" button **25** until the display shows "SLEEP OFF".

Displaying the Sleep time remaining

- To display the time remaining until the unit switches off during the countdown, press button **25** "SLEEP" once briefly.

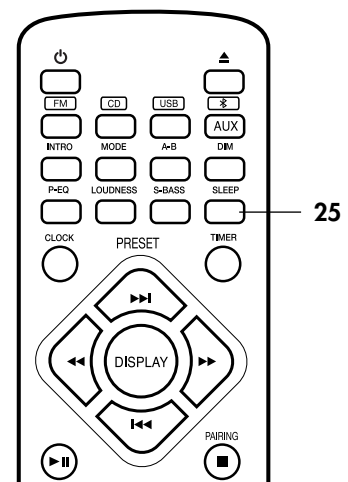

Timer / alarm function

This function allows you to program a time for the unit to switch on. The clock must be set to the correct time (see „Setting the time“ on page 13).

1. Switch the unit to standby using button **15** or button **48** "⏻". If the unit is in EcoPower mode, press button **42** "CLOCK" briefly to show the time.
2. Press and hold button **27** "TIMER" until the display shows "TIMER SET" followed by the type of operation (eg. "USB").
3. Select the type of operation to be active when the unit switches on (e.g. "TUNER") using buttons **28** "▶▶" / **30** "◀◀" or the volume control **10** "VOLUME".
4. Press button **27** "TIMER" once briefly. The display shows the time when the unit will switch on, the hour display is flashing.
5. Set the hour using buttons **28** "▶▶" / **30** "◀◀" or volume control **10** "VOLUME".
6. Press button **27** "TIMER" once briefly. The display will flash the minutes.
7. Set the minutes using buttons **28** "▶▶" / **30** "◀◀" or volume control **10** "VOLUME".
8. Press button **27** "TIMER" once briefly. The display will show the volume level when the unit switches on.
9. Set the desired volume using buttons **28** "▶▶" / **30** "◀◀" or volume control **10** "VOLUME".
10. Press button **27** "TIMER" once briefly. Programming is now complete. The current time is now displayed once again. The display shows the timer symbol ⏰ which indicates that this function is active.

The unit will switch itself on at the programmed time with the selected type of operation and with the selected volume level.

Switching the timer /alarm function on and off

1. Switch the unit to standby using button **15** or button **48** "⏻".
2. Press button **27** "TIMER" briefly to switch the timer function on and off.
 - **On:** Timer symbol ⏰ is displayed
 - **Off:** Timer symbol ⏰ is not displayed

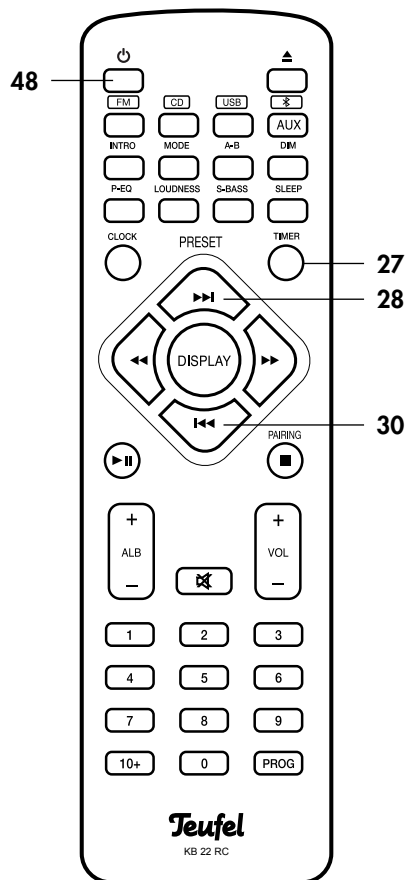
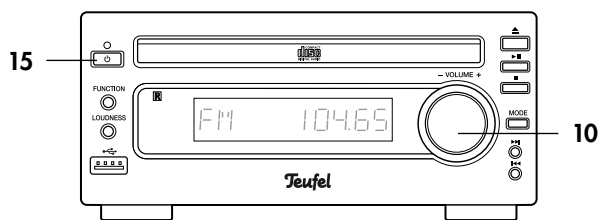

Troubleshooting

The following advice should help you to solve problems. If this doesn't work, please contact our hotline (see page 3). Take note of the warranty instructions.

Problem	Possible cause	Solution
The KB 22 CR is not working, the display does not light up.	The KB 22 CR has no power.	Check the mains adapter and the socket.
The KB 22 CR is not working, but the display does light up.	The volume has been set too low.	Increase the volume with control 10 "VOLUME" or 32 "Vol +".
	Wrong source selected.	Select the right source (see page 10).
No CD playback and/or "NO DISC" displayed.	No disc has been inserted.	Insert a CD.
	Disc has been inserted upside down.	Insert the disc with the labelled side facing up.
	CD dirty or damaged.	Clean or change the disc.
	Condensation in the device.	Take out the disc and do not use the device for one to two hours while activated.
No or disrupted music playback.	Files with a format other than MP3 or WMA are located on the storage device.	Delete the incorrect files.
	File damaged.	Delete or skip file.
The remote control is not working.	No clear line of sight between the remote control and the device.	Remove the obstacle.
	Remote control not properly aligned.	Point the remote control towards the device.
	Battery inserted in the remote control the wrong way round.	Insert the battery the right way round (see page 10).
	Remote control battery exhausted.	Insert a new battery (see page 10).
The sound is washed out and muffled.	Loudspeakers wrongly connected.	Both loudspeakers must be connected in the same way.

Care and cleaning

Clean the KB 22 CR and remote control regularly with a soft, damp microfibre cloth. Please be absolutely sure to observe the following notes in the process:

Danger Risk of electric shock!



In contact with live parts, water can lead to electric shock or short circuit.

- Make sure that no liquid penetrates the unit.
- Disconnect the mains plug before cleaning.

Attention Risk of damage!



Using the wrong cleaning materials may damage the delicate surface of the case.

- If possible, only use plain water without any additives. In case of stubborn marks, a mild soap solution may be used.
- In no circumstances should caustic cleaning products, white spirit, thinners, petrol or similar be used for cleaning.

How to clean your CDs

To clean your CDs use only cleaning products approved for this purpose.

If necessary carefully wipe the disc with a soft, lint free cloth from the centre to the rim. Hold the disc between the index finger and thumb of the other hand in the process.

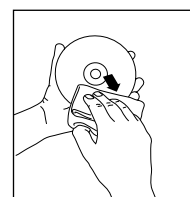

Touching the playing side of the disc with your hand can lead to problems during playback.



Protecting the environment

Disposal of the unit

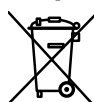

Used units must not be disposed of with household waste!

If the unit is no longer operational, every consumer is required by law to dispose of used devices separately from household waste, e.g. at a collection point run by the communal authority borough. In this way it is ensured, that used units are properly recycled and that negative consequences on the environment are avoided.

For this reason, electrical equipment is labelled with the displayed symbol.

Batteries and rechargeable batteries

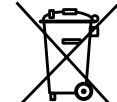

Batteries and rechargeable batteries must not be disposed of with household waste!

Every consumer is required by law to bring all batteries and rechargeable batteries, whether they contain harmful substances*) or not, to a collection point run by the communal authority or borough or run commercially, so that they can be disposed of in an environmentally friendly manner.

Please only hand in fully discharged batteries and rechargeable batteries!

*) labelled with: Cd = Cadmium, Hg = Mercury, Pb = Lead

Technical data

Operating voltage:	230 V / 50 Hz
Power consumption:	Operation: max. 60 watts Standby: < 1 watt EcoPower mode: ≤ 0.5 Watt
Dimensions (W x H x D):	15.9 x 7.8 x 28 cm
Net weight:	1440 g



This product conforms with Council of the European Union guidelines 2004/108/EC and 2006/95/EC.

Technical changes reserved!

Teufel

For questions, suggestions or any other issues please contact our customer service department:

Lautsprecher Teufel GmbH
Gewerbehof Buelowbogen - Aufgang D1
Buelowstr. 66, 10783 Berlin (Germany)

Phone: 00800 - 200 300 40
(toll-free)
Fax: +49 (0)30 / 300 930 930
www.teufelaudio.com

No responsibility is assumed for the
correctness of this information.
Technical changes, typographical
errors and other errors reserved.