



Nighthawk X4S
AC2600 Smart
WiFi Router
User Manual

Model R7800

April 2016
202-11596-04

350 E. Plumeria Drive
San Jose, CA 95134
USA

Nighthawk X4S AC2600 Smart WiFi Router

Support

Thank you for purchasing this NETGEAR product.

You can visit <http://support.netgear.com> to register your product, get help, access the latest downloads and user manuals, and join our community. We recommend that you use only official NETGEAR support resources.

Conformity

For regulatory compliance information, visit http://kb.netgear.com/app/answers/detail/a_id/11621.

Compliance

For regulatory compliance information, visit <http://www.netgear.com/about/regulatory>.

See the regulatory compliance document before connecting the power supply.

Trademarks

© NETGEAR, Inc., NETGEAR and the NETGEAR Logo are trademarks of NETGEAR, Inc. Any non_ NETGEAR trademarks are used for reference purposes only.

Contents

Chapter 1 Hardware Setup

Unpack Your Router.....	9
Top View.....	9
Rear Panel.....	11
Turn the LEDs On or Off.....	12
Attach the Antennas.....	12
USB Ports on the Left Panel.....	13
eSATA Port on the Right Panel.....	13
Connect an eSATA Device.....	14
Position Your Router.....	14
Cable Your Router.....	15

Chapter 2 Connect to the Network and Access the Router

Connect to the Network.....	18
Wired Connection.....	18
WiFi Connection Using WPS.....	18
WiFi Connection.....	18
Label.....	19
Types of Logins.....	19
Use a Web Browser to Access the Router.....	19
Log In to the Router.....	19
Automatic Internet Setup.....	20
Automatic Internet Setup With Two Routers.....	21
Access the Router With NETGEAR genie Apps.....	23

Chapter 3 Specify Your Internet Settings

Use the Internet Setup Wizard.....	25
Manually Set Up the Internet Connection.....	25
Specify an Internet Connection Without a Login.....	26
Specify an Internet Connection That Uses a Login.....	27
Specify IPv6 Internet Connections.....	29
Requirements for Entering IPv6 Addresses.....	30
Use Auto Config for an IPv6 Internet Connection.....	30
Use Auto Detect for an IPv6 Internet Connection.....	32
Set Up an IPv6 6rd Internet Connection.....	33
Set Up an IPv6 6to4 Tunnel Internet Connection.....	35
Set Up an IPv6 Pass Through Internet Connection.....	36
Set Up an IPv6 Fixed Internet Connection.....	37
Set Up an IPv6 DHCP Internet Connection.....	38
Set Up an IPv6 PPPoE Internet Connection.....	40
Change the MTU Size.....	41
Enable British Telecom IGMP Proxy Support.....	44

Chapter 4 Control Access to the Internet

Set Up Parental Controls.....46
Allow or Block Access to Your Network.....47
Use Keywords to Block Internet Sites.....48
 Block Services From the Internet.....49
 Delete Keywords From the Blocked List.....51
 Avoid Blocking on a Trusted Computer.....52
Manage Network Access Control Lists.....52
Schedule When to Block Internet Sites and Services.....53
Set Up Security Event Email Notifications.....55
Set Up IP-MAC Binding.....56

Chapter 5 Network Settings

View or Change WAN Settings.....58
Set Up a Default DMZ Server.....59
Change the Router’s Device Name.....60
Change the LAN TCP/IP Settings.....60
Specify the IP Addresses That the Router Assigns.....62
Disable the DHCP Server Feature in the Router.....64
Manage Reserved LAN IP Addresses.....64
 Reserve an IP Address.....64
 Edit a Reserved IP Address.....65
 Delete a Reserved IP Address Entry.....66
Use the WPS Wizard for WiFi Connections.....66
Specify Basic WiFi Settings.....67
Change the WiFi Mbps Settings.....70
Change the WiFi Password or Security Level.....71
Enable or Disable WiFi 160 MHz.....72
Enable a WiFi Video Network.....72
Set Up a Guest WiFi Network.....73
Enable a Video Guest WiFi Network.....75
Control the WiFi Radios.....76
 Use the WiFi On/Off Button.....76
 Enable or Disable the WiFi Radios.....76
Set Up a WiFi Schedule.....77
Specify WPS Settings.....78
Use the Router as a WiFi Access Point.....79
Use the Router in Bridge Mode.....80
Set Up a Bridge for a Port Group or VLAN Tag Group.....82
 Set Up a Bridge for a Port Group.....83
 Set Up a Bridge for a VLAN Tag Group.....84
 Set Up an IPTV Port to Lease an Intranet Port.....86

Chapter 6 Optimize Performance

Use Dynamic QoS to Optimize Internet Traffic Management.....89
 Enable Dynamic QoS.....89
 Enable or Disable the Automatic QoS Database Update.....90

Nighthawk X4S AC2600 Smart WiFi Router

Manually Update the Dynamic QoS Database.....	91
Participate in Dynamic QoS Analytics.....	91
Improve Network Connections With Universal Plug and Play.....	92
Wi-Fi Multimedia Quality of Service.....	93

Chapter 7 Manage Your Network

Update the Router Firmware.....	96
Change the admin Password.....	96
Set Up Password Recovery.....	97
Recover the admin Password.....	98
View Router Status.....	99
Display Internet Port Statistics.....	100
Check the Internet Connection Status.....	101
View and Manage Logs of Router Activity.....	102
View Devices Currently on the Network.....	103
Monitor Internet Traffictraffic metering.....	104
Manage the Router Configuration File.....	106
Back Up Settings.....	106
Erase the Current Configuration Settings.....	107
Restore Configuration Settings.....	107
Remote Access.....	108
Set Up Remote Management.....	108
Use Remote Access.....	109
Remotely Access Your Router Using the genie App.....	109

Chapter 8 Share USB Storage Devices Attached to the Router

USB Device Requirements.....	111
Connect a Storage Device to the Router.....	111
Access a Storage Device Connected to the Router From a Windows Computer.....	112
Map a USB Device to a Windows Network Drive.....	112
Access a Storage Device That Is Connected to the Router From a Mac.....	113
Back Up Windows Computers With ReadySHARE Vault.....	114
Back Up Mac Computers With Time Machine.....	114
Set Up a USB Hard Drive on a Mac.....	114
Prepare to Back Up a Large Amount of Data.....	115
Use Time Machine to Back Up Onto a USB Hard Disk.....	116
Use FTP Within the Network.....	117
View or Change Network Folders on a Storage Device.....	117
Add a Network Folder on a Storage Device.....	119
Edit a Network Folder on a Storage Device.....	120
Safely Remove a USB Device.....	121

Chapter 9 Use Dynamic DNS to Access USB Storage Devices Through the Internet

Set Up and Manage Dynamic DNS.....	123
Set Up FTP Access Through the Internet.....	123
Your Personal FTP Server.....	124
Set Up Your Personal FTP Server.....	124
Set Up a New Dynamic DNS Account.....	125

Nighthawk X4S AC2600 Smart WiFi Router

Specify a DNS Account That You Already Created.....	126
Change the Dynamic DNS Settings.....	127
Access USB Storage Devices Through the Internet.....	129
Remotely Access a USB Device Using ReadyCLOUD.....	129
Create a ReadyCLOUD Account.....	129
Register Your Router With ReadyCLOUD.....	130
Download Files Onto a USB Storage Device.....	132
Download Files.....	132
Change the Download Settings.....	133
Send Downloader Email Notifications.....	134
Manage Downloader Tasks.....	135
View Photos on Your USB Device With Kwiit.....	135

Chapter 10 Use the Router as a Media Server

Specify ReadyDLNA Media Server Settings.....	138
Play Music From a Storage Device With iTunes Server.....	138
Set Up the Router's iTunes Server With iTunes.....	139
Set Up the Router's iTunes Server With the Remote App.....	140
Play Media From a USB Device on TiVo.....	142
Set Up the Router to Work With TiVo.....	142
Play Videos on TiVo.....	143
Play Music or View Photos on TiVo.....	143

Chapter 11 Share a USB Printer

Install the Printer Driver and Cable the Printer.....	145
Download the ReadySHARE Printer Utility.....	145
Install the ReadySHARE Printer Utility.....	145
Print Using the NETGEAR USB Control Center.....	147
View or Change the Status of a Printer.....	147
Use the Scan Feature of a Multifunction USB Printer.....	148
Change NETGEAR USB Control Center Settings.....	148
Turn Off Automatic Startup for NETGEAR USB Control Center.....	148
Change the Language for the NETGEAR USB Control Center.....	149
Specify the USB Control Center Time-Out.....	149

Chapter 12 Customize Internet Traffic Rules for Ports

Port Forwarding to a Local Server.....	152
Set Up Port Forwarding to a Local Server.....	152
Add a Custom Port Forwarding Service.....	153
Edit a Port Forwarding Service.....	154
Delete a Port Forwarding Entry.....	155
Application Example: Make a Local Web Server Public.....	155
How the Router Implements the Port Forwarding Rule.....	156
Port Triggering.....	156
Add a Port Triggering Service.....	156
Enable Port Triggering.....	158
Application Example: Port Triggering for Internet Relay Chat port triggering.....	159

Chapter 13 Use VPN to Access Your Network

Set Up a VPN Connection.....161
Specify VPN Service in the Router.....161
Install OpenVPN Software.....162
 Install OpenVPN Software on Your Windows Computer.....162
 Install OpenVPN Software on Your Mac Computer.....165
 Install OpenVPN Software on an iOS Device.....165
 Install OpenVPN Software on an Android Device.....166
Use a VPN Tunnel on Your Windows Computer.....167
Use VPN to Access the Router’s USB Device and Media.....169
Use VPN to Access Your Internet Service at Home.....169
 Set Up VPN Client Internet Access in the Router.....169
 Block VPN Client Internet Access in the Router.....170
 Use a VPN Tunnel to Access Your Internet Service at Home.....171
Change VPN Pass-Through Settings.....171

Chapter 14 Troubleshooting

Quick Tips.....174
 Sequence to Restart Your Network.....174
 Check Ethernet Cable Connections.....174
 WiFi Settings.....174
 Network Settings.....174
Troubleshoot With the LEDs.....174
 Standard LED Behavior When the Router Is Powered On.....174
 Power LED Is Off or Blinking.....175
 Power LED Stays Amber.....175
 LEDs Never Turn Off.....175
 Internet or Ethernet Port LEDs Are Off.....176
 WiFi LED Is Off.....176
You Cannot Log In to the Router.....176
You Cannot Access the Internet.....177
Troubleshoot Internet Browsing.....178
Changes Are Not Saved.....178
Troubleshoot WiFi Connectivity.....179
Troubleshoot Your Network Using the Ping Utility.....179
 Test the LAN Path to Your Router.....179
 Test the Path From Your Computer to a Remote Device.....180

Chapter 15 Supplemental Information

Factory Settings.....183
Technical Specifications.....184

Hardware Setup

1

The Nighthawk X4S AC2600 Smart WiFi Router with four high-performance antennas and quad-stream X4S architecture combines four WiFi streams to deliver WiFi connection speeds of up to 1.73 Gbps, and a combined speed of 2.53 Gbps, as follows:

- 800 Mbps WiFi speed on the 2.4 GHz band
- 1.73 Gbps on the 5 GHz band
- Multiuser MIMO (MU-MIMO) for faster speeds with simultaneously streamed data for up to three devices
- 160 MHz bandwidth support for maximum performance for mobile devices

Nighthawk X4S is ideal for homes with a high volume of network and Internet traffic from gaming and streaming. With Dynamic QoS, the router optimizes performance based on the application and the device, and automatically performs cloud updates to optimize the most popular applications and services.

Nighthawk X4S also provides fast central storage, backup, and streaming to every device in your home with two USB 3.0 ports (10 times faster than USB 2.0) and an eSATA port. Sharing content across your network is easy, from accessing stored photos and music to printing wirelessly. Stream your stored media files on any device anywhere on the network. Share your music with AirPlay-compatible devices from a USB hard drive connected to the router. Use the free NETGEAR ReadySHARE Vault app to back up your Windows computers to a USB hard drive connected to Nighthawk X4S.

This chapter contains the following sections:

- *Unpack Your Router* on page 9
- *Top View* on page 9
- *Rear Panel* on page 11
- *Attach the Antennas* on page 12
- *USB Ports on the Left Panel* on page 13
- *eSATA Port on the Right Panel* on page 13
- *Position Your Router* on page 14
- *Cable Your Router* on page 15

For more information about the topics covered in this manual, visit the support website at support.netgear.com.

Unpack Your Router

Your package contains the router, four antennas, the power adapter, and an Ethernet cable.



Figure 1. Package contents

Top View

The status LEDs and buttons are located on the top of the router.

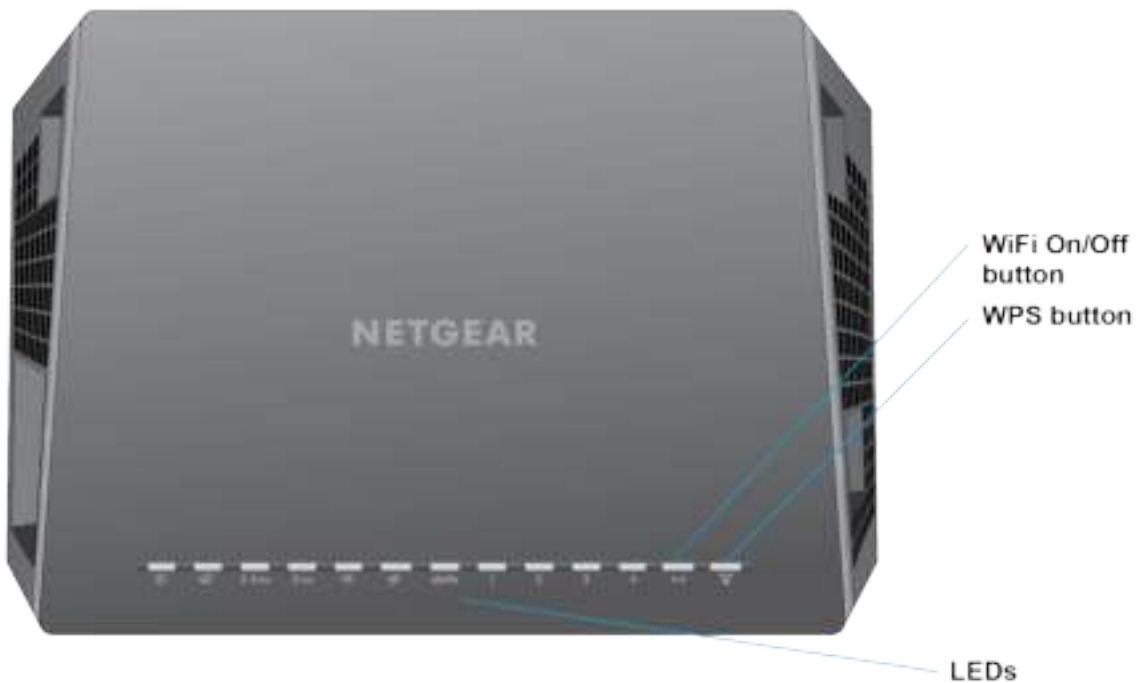



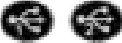





Figure 2. Router LEDs and buttons

Nighthawk X4S AC2600 Smart WiFi Router

Table 1. LED and button descriptions

LED	Description
Power 	<ul style="list-style-type: none"> • Solid amber. The router is starting. • Blinking amber. The firmware is upgrading, or the Reset button was pressed. • Solid white. The router is ready. • Blinking white. The firmware is corrupted. • Off. Power is not supplied to the router.
Internet 	<ul style="list-style-type: none"> • Solid white. The Internet connection is ready. • Solid amber. The router detected an Ethernet cable connection to the modem. • Off. No Ethernet cable is connected between the router and the modem.
2.4 GHz WiFi 	<ul style="list-style-type: none"> • Solid white. The 2.4 GHz WiFi radio is operating. • Blinking. The router is sending or receiving WiFi traffic. • Off. The 2.4 GHz WiFi radio is off.
5 GHz WiFi 	<ul style="list-style-type: none"> • Solid white. The 5 GHz WiFi radio is operating. • Blinking. The router is sending or receiving WiFi traffic. • Off. The 5 GHz WiFi radio is off.
USB 3.0 port 1 and USB 3.0 port 2 	<ul style="list-style-type: none"> • Solid white. A USB device is connected and is ready. • Blinking. A USB device is plugged in and is trying to connect. • Off. No USB device is connected, or someone clicked the Safely Remove Hardware button and it is now safe to remove the attached USB device.
eSATA 	<ul style="list-style-type: none"> • Solid white. An eSATA device is connected and is ready. • Blinking. An eSATA device is plugged in and is trying to connect. • Off. No eSATA device is connected.

Nighthawk X4S AC2600 Smart WiFi Router

LED	Description
Ethernet ports 1–4 	The LED color indicates the speed: white for Gigabit Ethernet connections and amber for 100 Mbps or 10 Mbps Ethernet connections. <ul style="list-style-type: none">• Solid. A powered-on device is connected to the Ethernet port.• Blinking. The port is sending or receiving traffic.• Off. No device is connected to this Ethernet port.
WiFi On/Off button with LED 	Pressing this button for two seconds turns the 2.4 GHz and 5 GHz WiFi radios on and off. If this LED is lit, the WiFi radios are on. If this LED is off, the WiFi radios are turned off and you cannot use WiFi to connect to the router.
WPS button with LED 	This button lets you use WPS to join the WiFi network without typing the WiFi password. The WPS LED blinks white during this process and then lights solid white.

You can use the **LED On/Off** switch on the rear panel of the router to turn the LEDs on the top of the router on or off. See [Turn the LEDs On or Off](#) on page 12.

Rear Panel

The rear panel connections and buttons are shown in the following figure.



Figure 3. Router rear panel

Pressing the **Reset** button restores the factory settings. See [Factory Settings](#) on page 183>.

Turn the LEDs On or Off

► To turn the LEDs on or off:

- Slide the **LED On/Off** switch on the rear panel to the On or Off position.



The Power LED stays lit even if the **LED On/Off** switch is in the Off position.

Attach the Antennas

The router comes with four antennas.

► To attach the antennas:

1. To determine where to attach the antennas, match the labels on the antennas with the labels on the router.

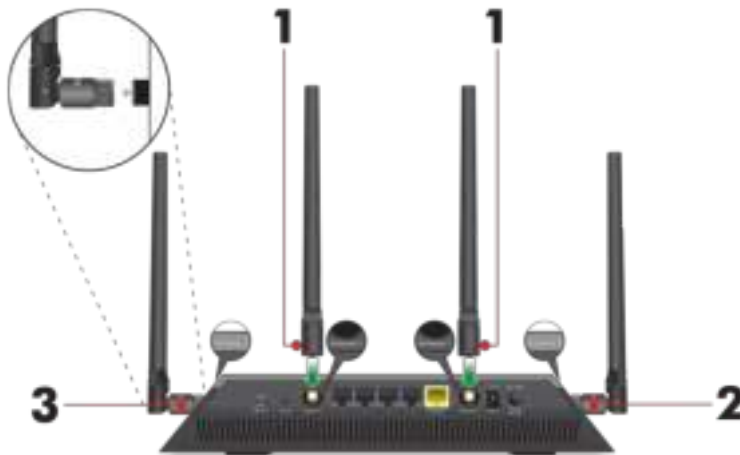

2. Align the antennas with the antenna posts on the router.
3. Attach the antennas on the threaded antenna posts.
4. Position the antennas for the best WiFi performance.

We recommend that you position all of the antennas vertically, as shown.

USB Ports on the Left Panel

Two 3.0 USB ports are located on the left panel.



Figure 4. USB ports

eSATA Port on the Right Panel

An eSATA port is located on the right panel.



Figure 5. eSATA port

Connect an eSATA Device

▶ To connect an eSATA device:

- Use an eSATA cable to connect your device to the eSATA port on the side of the router as shown.



Position Your Router

The router lets you access your network anywhere within the operating range of your WiFi network. However, the operating distance or range of your WiFi connection can vary significantly depending on the physical placement of your router. For example, the thickness and number of walls the WiFi signal passes through can limit the range.

Additionally, other WiFi access points in and around your home might affect your router's signal. WiFi access points are routers, repeaters, WiFi range extenders, and any other device that emits a WiFi signal for network access.

Position your router according to the following guidelines:

- Place your router near the center of the area where your computers and other devices operate, and within line of sight to your WiFi devices.
- Make sure that the router is within reach of an AC power outlet and near Ethernet cables for wired computers.
- Place the router in an elevated location, minimizing the number walls and ceilings between the router and your other devices.
- Place the router away from electrical devices such as these:
 - Ceiling fans
 - Home security systems
 - Microwaves
 - Computers

Nighthawk X4S AC2600 Smart WiFi Router

- Base of a cordless phone
- 2.4 GHz cordless phone
- Place the router away from large metal surfaces, large glass surfaces, insulated walls, and items such as these:
 - Solid metal door
 - Aluminum studs
 - Fish tanks
 - Mirrors
 - Brick
 - Concrete

Cable Your Router

The following image shows how to cable your router:

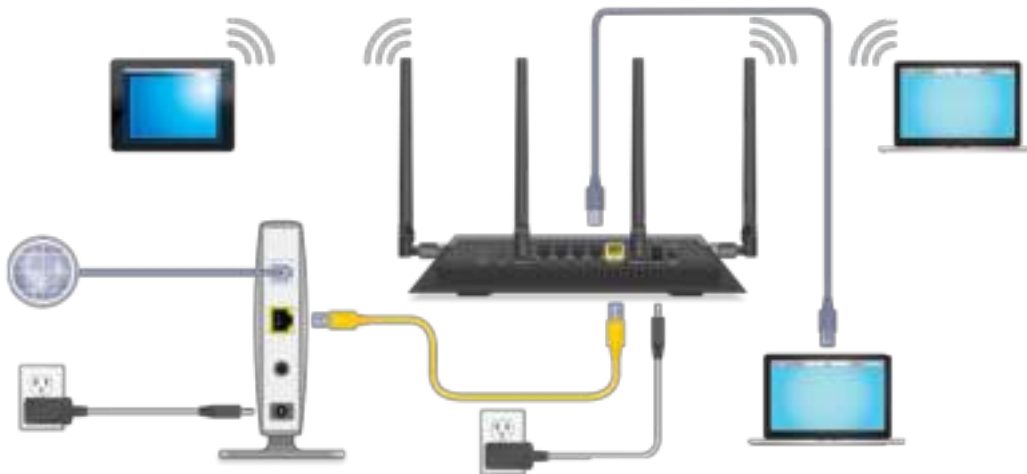

Figure 6. Router cabling

► To cable your router:

1. Unplug your modem's power, leaving the modem connected to the wall jack for your Internet service.
If your modem uses a battery backup, remove the battery.
2. Plug in and turn on your modem.
If your modem uses a battery backup, put the battery back in.

Nighthawk X4S AC2600 Smart WiFi Router

3. Connect your modem to the Internet port of your router with the yellow Ethernet cable that came with your router.
4. Connect the power adapter to your router and plug the power adapter into an outlet.
5. Slide the **LED On/Off** switch on the rear panel to the On position.
6. Press the **Power On/Off** button on the rear panel of the router.

Connect to the Network and Access the Router

2

You can connect to the router's WiFi networks or use a wired Ethernet connection. This chapter explains the ways you can connect and how to access the router and log in.

The chapter contains the following sections:

- *Connect to the Network* on page 18
- *Types of Logins* on page 19
- *Use a Web Browser to Access the Router* on page 19
- *Automatic Internet Setup* on page 20
- *Automatic Internet Setup With Two Routers* on page 21
- *Access the Router With NETGEAR genie Apps* on page 23

Connect to the Network

You can connect to the router network through a wired or WiFi connection. If you set up your computer to use a static IP address, change the settings so that it uses Dynamic Host Configuration Protocol (DHCP).

Wired Connection

You can connect your computer to the router using an Ethernet cable and join the router's local area network (LAN).

▶ To connect your computer to the router with an Ethernet cable:

1. Make sure that the router is receiving power (its Power LED is lit).
2. Connect an Ethernet cable to an Ethernet port on your computer.
3. Connect the other end of the Ethernet cable to one of the numbered Ethernet ports.

Your computer connects to the local area network (LAN). A message might display on your computer screen to notify you that an Ethernet cable is connected.

WiFi Connection Using WPS

You can connect to the router's WiFi network with Wi-Fi Protected Setup (WPS) or you can find and select the WiFi network.

▶ To use WPS to connect to the WiFi network:

1. Make sure that the router is receiving power (its Power LED is lit).
2. Check the WPS instructions for your computer or WiFi device.
3. Press the **WPS** button on the router.
4. Within two minutes, on your computer or WiFi device, press its **WPS** button or follow its instructions for WPS connections.

Your computer or WiFi device connects to the WiFi network.

WiFi Connection

▶ To find and select the WiFi network:

1. Make sure that the router is receiving power (its Power LED is lit).
2. On your computer or WiFi device, find and select the WiFi network.

The WiFi network name is on the label on the router.

3. Join the WiFi network and enter the WiFi password.

The password is on the label on the router.

Nighthawk X4S AC2600 Smart WiFi Router

Your WiFi device connects to the WiFi network.

Label

The product label shows the login information, WiFi network name and network key (password), MAC address, and serial number.



Figure 7. Product label

Types of Logins

Separate types of logins serve different purposes. It is important that you understand the difference so that you know which login to use when.

Several types of logins are associated with the router:

- **ISP login.** The login that your ISP gave you logs you in to your Internet service. Your service provider gave you this login information in a letter or some other way. If you cannot find this login information, contact your service provider.
- **WiFi network key or password.** Your router is preset with a unique WiFi network name (SSID) and password for WiFi access. This information is on the label on the router.
- **Router login.** This logs you in to the router interface from a web browser as admin.

Use a Web Browser to Access the Router

When you connect to the network (either with WiFi or with an Ethernet cable), you can use a web browser to access the router to view or change its settings. When you access the router, the software automatically checks to see if your router can connect to your Internet service.

Log In to the Router

When you first connect to your router and launch a web browser, the browser automatically displays the router's web page. If you want to view or change settings for the router later, you can use a browser to log in to the router's web page.

► To log in to the router:

1. Launch a web browser from a computer or WiFi device that is connected to the network.
2. Enter **http://www.routerlogin.net**.

Note You can also enter **http://www.routerlogin.com** or enter the router's IP address in this format: **http://192.168.1.1**. The default IP address for the router is **http://192.168.1.1**. If the router detects a conflict with a WAN IP address, it changes its IP address to 10.0.0.1 or 172.16.5.1. The procedures in this manual use **http://www.routerlogin.net**.

A login window opens.

3. Enter the router user name and password.

The user name is **admin**. The default password is **password**. The user name and password are case-sensitive.

The BASIC Home page displays.

Automatic Internet Setup

You can let the NETGEAR installation assistant set up your router automatically, or you can set up your router manually. Before you start the setup process, get your ISP information and make sure that the computers and devices in the network are using the settings described here. If you are installing a new router on a network that already includes a router, see *Automatic Internet Setup With Two Routers* on page 21.

When your Internet service starts, your Internet service provider (ISP) typically gives you all the information needed to connect to the Internet. For DSL service, you might need the following information to set up your router:

- The ISP configuration information for your DSL account
- ISP login name and password
- Fixed or static IP address setting (special deployment by ISP; this setting is rare)

If you cannot locate this information, ask your ISP to provide it. When your Internet connection is working, you no longer need to launch the ISP login program on your computer to access the Internet. When you start an Internet application, your router automatically logs you in.

The NETGEAR installation assistant runs on any device with a web browser. Installation and basic setup takes about 15 minutes to complete.

► To use the NETGEAR installation assistant to automatically set up your router:

1. Turn the router on by pressing the **On/Off** button.
2. Make sure that your computer or WiFi device is connected to the router with an Ethernet cable (wired) or over WiFi with the preset security settings listed on the label.

Note If you want to change the router's WiFi settings, use a wired connection to avoid being disconnected when the new WiFi settings take effect.

3. Launch a web browser.

The page that displays depends on whether you accessed the router before or if the the router is connected to another router or gateway:

- The first time you set up the Internet connection for your router, the browser goes to <http://www.routerlogin.net> and the Configuring the Internet Connection page displays.
- If the NETGEAR installation assistant detects that the router is connected to another router or gateway, you are prompted to set up the router in router mode or access point mode. See [Automatic Internet Setup With Two Routers](#) on page 21.
- If you already set up the Internet connection, enter **<http://www.routerlogin.net>** in the address field for your browser to start the installation process.

4. Follow the onscreen instructions.

The NETGEAR installation assistant guides you through connecting the router to the Internet.

5. If the browser does not display a router page, do the following:

- Make sure that the computer is connected to one of the LAN Ethernet ports or over WiFi to the router.
- Make sure that the router is receiving power and that its Power LED is lit.
- Close and reopen the browser or clear the browser cache.
- Browse to **<http://www.routerlogin.net>**.
- If the computer is set to a static or fixed IP address (this setting is uncommon), change it to obtain an IP address automatically from the router.

6. If the router does not connect to the Internet, do the following:

- a. Review your settings. Make sure that you selected the correct options and typed everything correctly.
- b. Contact your ISP to verify that you are using the correct configuration information.
- c. Read [You Cannot Access the Internet](#) on page 177. If problems persist, register your product and contact NETGEAR technical support.

When the router connects to the Internet, you are prompted to download and install the free NETGEAR Desktop genie app and the free ReadySHARE Vault app.

Automatic Internet Setup With Two Routers

You can let the NETGEAR installation assistant set up your router automatically, or you can set up your router manually. Before you start the setup process, get your ISP information and make sure that the computers and devices in the network are using the settings described here. If you are connecting only one router to your Internet connection, see [Automatic Internet Setup](#) on page 20.

Nighthawk X4S AC2600 Smart WiFi Router

When your Internet service starts, your Internet service provider (ISP) typically gives you all the information needed to connect to the Internet. For DSL service, you might need the following information to set up your router:

- The ISP configuration information for your DSL account
- ISP login name and password
- Fixed or static IP address setting (special deployment by ISP; this setting is rare)

If you cannot locate this information, ask your ISP to provide it. When your Internet connection is working, you no longer need to launch the ISP login program on your computer to access the Internet. When you start an Internet application, your router automatically logs you in.

The NETGEAR installation assistant runs on any device with a web browser. Installation and basic setup takes about 15 minutes to complete.

▶ To use the NETGEAR installation assistant to automatically set up your router on a network with another router:

1. Turn the router on by pressing the **On/Off** button.
2. Make sure that your computer or WiFi device is connected to the router with an Ethernet cable (wired) or over WiFi with the preset security settings listed on the label.

Note If you want to change the router's WiFi settings, use a wired connection to avoid being disconnected when the new WiFi settings take effect.

3. Launch a web browser.

The page that displays depends on whether you accessed the router before or if the the router is connected to another router or gateway:

- The first time you set up the Internet connection for your router, the browser goes to <http://www.routerlogin.net> and the Configuring the Internet Connection page displays.
- If the NETGEAR installation assistant detects that the router is connected to another router or gateway, you are prompted to set up the router in router mode or access point mode.
- If you already set up the Internet connection, enter **<http://www.routerlogin.net>** in the address field for your browser to start the installation process.

4. Select the **Help Me Choose** radio button or **Let Me Choose** radio button:

- **Help Me Choose.** If you select this radio button, the NETGEAR installation assistant asks you a few questions to determine if you should set the router in router mode or access point mode. We recommend that you select the **Help Me Choose** radio button.
- **Let Me Choose.** If you select this radio button, you must select the **Router Mode** radio button or the **Access Point Mode** radio button. You can change the mode by running the Setup Wizard again. For more information, see [Use the Internet Setup Wizard](#) on page 25.

5. Follow the onscreen instructions.

The NETGEAR installation assistant guides you through connecting the router to the Internet.

Connect to the Network and Access the Router

Nighthawk X4S AC2600 Smart WiFi Router

6. If the browser does not display a router page, do the following:
 - Make sure that the computer is connected to one of the LAN Ethernet ports or over WiFi to the router.
 - Make sure that the router is receiving power and that its Power LED is lit.
 - Close and reopen the browser or clear the browser cache.
 - Browse to **http://www.routerlogin.net**.
 - If the computer is set to a static or fixed IP address (this setting is uncommon), change it to obtain an IP address automatically from the router.
7. If the router does not connect to the Internet, do the following:
 - a. Review your settings. Make sure that you selected the correct options and typed everything correctly.
 - b. Contact your ISP to verify that you are using the correct configuration information.
 - c. Read *You Cannot Access the Internet* on page 177. If problems persist, register your product and contact NETGEAR technical support.

When the router connects to the Internet, you are prompted to download and install the free NETGEAR Desktop genie app and the free ReadySHARE Vault app.

Access the Router With NETGEAR genie Apps

The genie app is the easy dashboard for managing, monitoring, and repairing your home network. The genie app can help you with the following:

- Automatically repair common WiFi network problems.
- Easily manage router features like Live Parental Controls, guest access, Internet traffic meter, speed test, and more.

► To use the genie app to access the router:

1. Visit the NETGEAR genie web page at www.NETGEAR.com/genie.
2. Follow the onscreen instructions to install the app on your smartphone, tablet, or computer.
3. Launch the genie app.

The genie app dashboard page displays.

Specify Your Internet Settings

3

Usually, the quickest way to set up the router to use your Internet connection is to allow the genie to detect the Internet connection when you first access the router with a web browser. You can also customize or specify your Internet settings.

This chapter contains the following sections:

- *Use the Internet Setup Wizard* on page 25
- *Manually Set Up the Internet Connection* on page 25
- *Specify IPv6 Internet Connections* on page 29
- *Change the MTU Size* on page 41
- *Enable British Telecom IGMP Proxy Support* on page 44

Use the Internet Setup Wizard

You can use the Setup Wizard to detect your Internet settings and automatically set up your router. The Setup Wizard is not the same as the pages that display the first time you connect to your router to set it up.

► To use the Setup Wizard:

1. Launch a web browser from a computer or WiFi device that is connected to the network.
2. Enter **http://www.routerlogin.net**.

A login window opens.

3. Enter the router user name and password.

The user name is **admin**. The default password is **password**. The user name and password are case-sensitive.

The BASIC Home page displays.

4. Select **ADVANCED > Setup Wizard**.

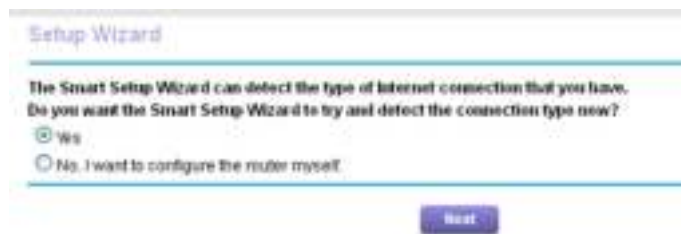

5. Select the **Yes** radio button.

If you select the **No** radio button, you are taken to the Internet Setup page (see [Manually Set Up the Internet Connection](#) on page 25).

6. Click the **Next** button.

The Setup Wizard searches your Internet connection for servers and protocols to determine your Internet configuration.

When the router connects to the Internet, you are prompted to download and install the free NETGEAR Desktop genie app and the free ReadySHARE Vault app.

Manually Set Up the Internet Connection

You can view or change the router's Internet connection settings.

Specify an Internet Connection Without a Login

► **To specify the Internet connection settings:**

1. Launch a web browser from a computer or WiFi device that is connected to the network.
2. Enter **http://www.routerlogin.net**.

A login window opens.

3. Enter the router user name and password.

The user name is **admin**. The default password is **password**. The user name and password are case-sensitive.

The BASIC Home page displays.

4. Select **Internet**.



Your router might display information that is different from this example.

5. For the Does your Internet connection require a login? setting, leave the **No** radio button selected.
6. If your Internet connection requires an account name or host name, type it in the **Account Name (If Required)** field.
7. If your Internet connection requires a domain name, type it in the **Domain Name (If Required)** field.

For the other sections on this page, the default settings usually work, but you can change them.

8. Select an Internet IP Address radio button:

- **Get Dynamically from ISP**. Your ISP uses DHCP to assign your IP address. Your ISP automatically assigns these addresses.

Nighthawk X4S AC2600 Smart WiFi Router

- **Use Static IP Address.** Enter the IP address, IP subnet mask, and the gateway IP address that your ISP assigned. The gateway is the ISP router to which your router connects.
9. Select a Domain Name Server (DNS) Address radio button:
 - **Get Automatically from ISP.** Your ISP uses DHCP to assign your DNS servers. Your ISP automatically assigns this address.
 - **Use These DNS Servers.** If you know that your ISP requires specific servers, select this option. Enter the IP address of your ISP's primary DNS server. If a secondary DNS server address is available, enter it also.
 10. Select a Router MAC Address radio button:
 - **Use Default Address.** Use the default MAC address.
 - **Use Computer MAC Address.** The router captures and uses the MAC address of the computer that you are now using. You must use the one computer that the ISP allows.
 - **Use This MAC Address.** Enter the MAC address that you want to use.
 11. Click the **Apply** button.

Your settings are saved.
 12. Click the **Test** button to test your Internet connection.

If the NETGEAR website does not display within one minute, see *You Cannot Access the Internet* on page 177.

Specify an Internet Connection That Uses a Login

► To view or change the basic Internet setup:

1. Launch a web browser from a computer or WiFi device that is connected to the network.
2. Enter **http://www.routerlogin.net**.

A login window opens.
3. Enter the router user name and password.

The user name is **admin**. The default password is **password**. The user name and password are case-sensitive.
The BASIC Home page displays.
4. Select **Internet**.

Nighthawk X4S AC2600 Smart WiFi Router

Internet Setup

Test Cancel Apply

Does your Internet connection require a login?

Yes

No

Account Name (if Required) R0500

Domain Name (if Required)

Internet IP Address

Get Dynamically from ISP

Use Static IP Address

IP Address

IP Subnet Mask

Gateway IP Address

Domain Name Server (DNS) Address

Get Automatically from ISP

Use These DNS Servers

Primary DNS

Secondary DNS

Third DNS

Router MAC Address

Use Default Address

Help Center Show/Hide Help Center

Scroll to view more settings

5. For the Does your Internet connection require a login? setting, select the **Yes** radio button.
6. From the **Internet Service Provider** menu, select the encapsulation method: **PPPoE**, **L2TP**, or **PPTP**.
7. In the **Login** field, enter the login name that your ISP gave you.
This login name is often an email address.
8. In the **Password** field, type the password that you use to log in to your Internet service.
9. If your ISP requires a service name, type it in the **Service Name (if Required)** field.
10. From the **Connection Mode** menu, select **Always On**, **Dial on Demand**, or **Manually Connect**.
11. To change the number of minutes until the Internet login times out, in the **Idle Timeout (In minutes)** field, type the number of minutes.
This is how long the router keeps the Internet connection active when no one on the network is using the Internet connection. A value of 0 (zero) means never log out.
12. Select an Internet IP Address radio button:
 - **Get Dynamically from ISP**. Your ISP uses DHCP to assign your IP address. Your ISP automatically assigns these addresses.
 - **Use Static IP Address**. Enter the IP address, IP subnet mask, and the gateway IP address that your ISP assigned. The gateway is the ISP router to which your router connects.
13. Select a Domain Name Server (DNS) Address radio button:

Specify Your Internet Settings

- **Get Automatically from ISP.** Your ISP uses DHCP to assign your DNS servers. Your ISP automatically assigns this address.
- **Use These DNS Servers.** If you know that your ISP requires specific servers, select this option. Enter the IP address of your ISP's primary DNS server. If a secondary DNS server address is available, enter it also.

14. Select a Router MAC Address radio button:

- **Use Default Address.** Use the default MAC address.
- **Use Computer MAC Address.** The router captures and uses the MAC address of the computer that you are now using. You must use the one computer that the ISP allows.
- **Use This MAC Address.** Enter the MAC address that you want to use.

15. Click the **Apply** button.

Your settings are saved.

16. Click the **Test** button to test your Internet connection.

If the NETGEAR website does not display within one minute, see [You Cannot Access the Internet](#) on page 177.

Specify IPv6 Internet Connections

You can set up an IPv6 Internet connection if the router does not detect it automatically.

► To set up an IPv6 Internet connection:

1. Launch a web browser from a computer or WiFi device that is connected to the network.
2. Enter **http://www.routerlogin.net**.
A login window opens.
3. Enter the router user name and password.
The user name is **admin**. The default password is **password**. The user name and password are case-sensitive.
The BASIC Home page displays.
4. Select **ADVANCED > Advanced Setup > IPv6**.
The IPv6 page displays.
5. From the **Internet Connection Type** menu, select the IPv6 connection type:
 - If your ISP did not provide details, select **IPv6 Tunnel**.
 - If you are not sure, select **Auto Detect** so that the router detects the IPv6 type that is in use.
 - If your Internet connection does not use PPPoE or DHCP, or is not fixed, but is IPv6, select **Auto Config**.

Your Internet service provider (ISP) can provide this information. For more information about IPv6 Internet connection, see the following sections:

- [Use Auto Detect for an IPv6 Internet Connection](#) on page 32
- [Use Auto Config for an IPv6 Internet Connection](#) on page 30

- *Set Up an IPv6 6rd Internet Connection* on page 33
- *Set Up an IPv6 6to4 Tunnel Internet Connection* on page 35
- *Set Up an IPv6 Pass Through Internet Connection* on page 36
- *Set Up an IPv6 Fixed Internet Connection* on page 37
- *Set Up an IPv6 DHCP Internet Connection* on page 38
- *Set Up an IPv6 PPPoE Internet Connection* on page 40

6. Click the **Apply** button.
Your settings are saved.

Requirements for Entering IPv6 Addresses

IPv6 addresses are denoted by eight groups of hexadecimal quartets that are separated by colons. You can reduce any four-digit group of zeros within an IPv6 address to a single zero or omit it. The following errors invalidate an IPv6 address:

- More than eight groups of hexadecimal quartets
- More than four hexadecimal characters in a quartet
- More than two colons in a row

Use Auto Config for an IPv6 Internet Connection

► To set up an IPv6 Internet connection through autoconfiguration:

1. Launch a web browser from a computer or WiFi device that is connected to the network.
2. Enter **http://www.routerlogin.net**.

A login window opens.

3. Enter the router user name and password.

The user name is **admin**. The default password is **password**. The user name and password are case-sensitive.

The BASIC Home page displays.

4. Select **ADVANCED > Advanced Setup > IPv6**.

The IPv6 page displays.

5. From the **Internet Connection Type** menu, select **Auto Config**.

Nighthawk X4S AC2600 Smart WiFi Router

The screenshot shows the IPv6 configuration interface. At the top, there are three buttons: 'Status Refresh', 'Cancel', and 'Apply'. Below these, the 'Internet Connection Type' is set to 'Auto Config'. There are three input fields: 'DHCP User Class (If Required)', 'DHCP Domain Name (If Required)', and 'Router's IPv6 Address On WAN' (displaying 'Not Available'). The 'LAN Setup' section includes 'Router's IPv6 Address On LAN' (displaying 'Not Available'), 'IP Address Assignment' with radio buttons for 'Use DHCP Server' and 'Auto Config' (selected), and a checkbox for 'Use This Interface ID' with four input boxes. At the bottom, 'IPv6 Filtering' is set to 'Secured'.

The router automatically detects the information in the following fields:

- **Router's IPv6 Address on WAN.** This field shows the IPv6 address that is acquired for the router's WAN (or Internet) interface. The number after the slash (/) is the length of the prefix, which is also indicated by the underline () under the IPv6 address. If no address is acquired, the field displays Not Available.
- **Router's IPv6 Address on LAN.** This field shows the IPv6 address that is acquired for the router's LAN interface. The number after the slash (/) is the length of the prefix, which is also indicated by the underline () under the IPv6 address. If no address is acquired, the field displays Not Available.

6. (Optional) In the **DHCP User Class (If Required)** field, enter a host name.

Most people can leave this field blank, but if your ISP gave you a specific host name, enter it here.

7. (Optional) In the **DHCP Domain Name (If Required)** field, enter a domain name.

You can type the domain name of your IPv6 ISP. Do not enter the domain name for the IPv4 ISP here. For example, if your ISP's mail server is mail.xxx.yyy.zzz, type xxx.yyy.zzz as the domain name. If your ISP provided a domain name, type it in this field. For example, Earthlink Cable might require a host name of home, and Comcast sometimes supplies a domain name.

8. Select an IP Address Assignment radio button:

- **Use DHCP Server.** This method passes more information to LAN devices but some IPv6 systems might not support the DHCv6 client function.
- **Auto Config.** This is the default setting.

This setting specifies how the router assigns IPv6 addresses to the devices on your home network (the LAN).

Specify Your Internet Settings

- (Optional) Select the **Use This Interface ID** check box and specify the interface ID to be used for the IPv6 address of the router's LAN interface.

If you do not specify an ID here, the router generates one automatically from its MAC address.

- Click the **Apply** button.

Your settings are saved.

Use Auto Detect for an IPv6 Internet Connection

► To set up an IPv6 Internet connection through autodetection:

- Launch a web browser from a computer or WiFi device that is connected to the network.
- Enter **http://www.routerlogin.net**.

A login window opens.

- Enter the router user name and password.

The user name is **admin**. The default password is **password**. The user name and password are case-sensitive.

The BASIC Home page displays.

- Select **ADVANCED > Advanced Setup > IPv6**.



- From the **Internet Connection Type** menu, select **Auto Detect**.

The router automatically detects the information in the following fields:

Nighthawk X4S AC2600 Smart WiFi Router

- **Connection Type.** This field indicates the connection type that is detected.
- **Router's IPv6 Address on WAN.** This field shows the IPv6 address that is acquired for the router's WAN (or Internet) interface. The number after the slash (/) is the length of the prefix, which is also indicated by the underline (_) under the IPv6 address. If no address is acquired, the field displays Not Available.
- **Router's IPv6 Address on LAN.** This field shows the IPv6 address that is acquired for the router's LAN interface. The number after the slash (/) is the length of the prefix, which is also indicated by the underline (_) under the IPv6 address. If no address is acquired, the field displays Not Available.

6. Select an IP Address Assignment radio button:

- **Use DHCP Server.** This method passes more information to LAN devices but some IPv6 systems might not support the DHCPv6 client function.
- **Auto Config.** This is the default setting.

This setting specifies how the router assigns IPv6 addresses to the devices on your home network (the LAN).

7. (Optional) Select the **Use This Interface ID** check box and specify the interface ID to be used for the IPv6 address of the router's LAN interface.

If you do not specify an ID here, the router generates one automatically from its MAC address.

8. Click the **Apply** button.

Your settings are saved.

Set Up an IPv6 6rd Internet Connection

The 6rd protocol makes it possible to deploy IPv6 to sites using a service provider's IPv4 network. 6rd uses the service provider's own IPv6 address prefix. This limits the operational domain of 6rd to the service provider's network and is under direct control of the service provider. The IPv6 service provided is equivalent to native IPv6. The 6rd mechanism relies on an algorithmic mapping between the IPv6 and IPv4 addresses that are assigned for use within the service provider's network. This mapping allows for automatic determination of IPv4 tunnel endpoints from IPv6 prefixes, allowing stateless operation of 6rd.

With a 6rd tunnel configuration, the router follows the RFC5969 standard, supporting two ways to establish a 6rd tunnel IPv6 WAN connection:

- **Auto Detect mode.** In IPv6 Auto Detect mode, when the router receives option 212 from the DHCPv4 option, autodetect selects the IPv6 as 6rd tunnel setting. The router uses the 6rd option information to establish the 6rd connection.
- **Manual mode.** Select **6rd Tunnel**. If the router receives option 212, the fields are automatically completed. Otherwise, you must enter the 6rd settings.

► To set up an IPv6 6rd Internet connection:

1. Launch a web browser from a computer or WiFi device that is connected to the network.
2. Enter **http://www.routerlogin.net**.

A login window opens.

3. Enter the router user name and password.

The user name is **admin**. The default password is **password**. The user name and password are case-sensitive.

The BASIC Home page displays.

4. Select **ADVANCED > Advanced Setup > IPv6**.

5. From the **Internet Connection Type** menu, select **6rd Tunnel**.

The page adjusts. The router automatically detects the information in the following sections:

- **6rd (IPv6 Rapid Development) Configuration.** The router detects the service provider's IPv4 network and attempts to establish an IPv6 6rd tunnel connection. If the IPv4 network returns 6rd parameters to the router, the page adjusts to display the correct settings in this section.
- **Router's IPv6 Address on LAN.** This field shows the IPv6 address that is acquired for the router's LAN interface. The number after the slash (/) is the length of the prefix, which is also indicated by the underline () under the IPv6 address. If no address is acquired, the field displays Not Available.
- **MTU size (in bytes).** The normal MTU (maximum transmit unit) value for most Ethernet networks is 1500 bytes, or 1492 bytes for PPPoE connections. Change the MTU only if you are sure that it is necessary for your ISP connection. For more information about changing the MTU size, see [Change the MTU Size](#) on page 41.

6. Select an IPv6 Domain Name Server (DNS) Address radio button:

Nighthawk X4S AC2600 Smart WiFi Router

- **Get Automatically from ISP.** Your ISP uses DHCP to assign your DNS servers. Your ISP automatically assigns this address.
 - **Use These DNS Servers.** If you know that your ISP requires specific servers, select this option. Enter the IP address of your ISP's primary DNS server. If a secondary DNS server address is available, enter it also.
7. Select an IP Address Assignment radio button:
- **Use DHCP Server.** This method passes more information to LAN devices but some IPv6 systems might not support the DHCPv6 client function.
 - **Auto Config.** This is the default setting.
This setting specifies how the router assigns IPv6 addresses to the devices on your home network (the LAN).
8. (Optional) Select the **Use This Interface ID** check box and specify the interface ID that you want to be used for the IPv6 address of the router's LAN interface.
- If you do not specify an ID here, the router generates one automatically from its MAC address.
9. Click the **Apply** button.
- Your settings are saved.

Set Up an IPv6 6to4 Tunnel Internet Connection

The remote relay router is the router to which your router creates a 6to4 tunnel. Make sure that the IPv4 Internet connection is working before you apply the 6to4 tunnel settings for the IPv6 connection.

► To set up an IPv6 Internet connection by using a 6to4 tunnel:

1. Launch a web browser from a computer or WiFi device that is connected to the network.
2. Enter **http://www.routerlogin.net**.
A login window opens.
3. Enter the router user name and password.
The user name is **admin**. The default password is **password**. The user name and password are case-sensitive.
The BASIC Home page displays.
4. Select **ADVANCED > Advanced Setup > IPv6**.
The IPv6 page displays.
5. From the **Internet Connection Type** menu, select **6to4 Tunnel**.

The router automatically detects the information in the Router's IPv6 Address on LAN field. This field shows the IPv6 address that is acquired for the router's LAN interface. The number after the slash (/) is the length of the prefix, which is also indicated by the underline () under the IPv6 address. If no address is acquired, the field displays Not Available.

6. Select a Remote 6to4 Relay Router radio button:
 - **Auto.** Your router uses any remote relay router that is available on the Internet. This is the default setting.
 - **Static IP Address.** Enter the static IPv4 address of the remote relay router. Your IPv6 ISP usually provides this address.
7. Select an IP Address Assignment radio button:
 - **Use DHCP Server.** This method passes more information to LAN devices but some IPv6 systems might not support the DHCPv6 client function.
 - **Auto Config.** This is the default setting.

This setting specifies how the router assigns IPv6 addresses to the devices on your home network (the LAN).

8. (Optional) Select the **Use This Interface ID** check box and specify the interface ID to be used for the IPv6 address of the router's LAN interface.

If you do not specify an ID here, the router generates one automatically from its MAC address.

9. Click the **Apply** button.

Your settings are saved.

Set Up an IPv6 Pass Through Internet Connection

In pass-through mode, the router works as a Layer 2 Ethernet switch with two ports (LAN and WAN Ethernet ports) for IPv6 packets. The router does not process any IPv6 header packets.

▶ To set up a pass-through IPv6 Internet connection:

1. Launch a web browser from a computer or WiFi device that is connected to the network.
2. Enter **http://www.routerlogin.net**.

A login window opens.

3. Enter the router user name and password.

The user name is **admin**. The default password is **password**. The user name and password are case-sensitive.

The BASIC Home page displays.

4. Select **ADVANCED > Advanced Setup > IPv6**.

The IPv6 page displays.

5. From the **Internet Connection Type** menu, select **Pass Through**.

The page adjusts, but no additional fields display.

6. Click the **Apply** button.

Your settings are saved.

Set Up an IPv6 Fixed Internet Connection

► To set up a fixed IPv6 Internet connection:

1. Launch a web browser from a computer or WiFi device that is connected to the network.
2. Enter **http://www.routerlogin.net**.

A login window opens.

3. Enter the router user name and password.

The user name is **admin**. The default password is **password**. The user name and password are case-sensitive.

The BASIC Home page displays.

4. Select **ADVANCED > Advanced Setup > IPv6**.

The IPv6 page displays.

5. From the **Internet Connection Type** menu, select **Fixed**.

The screenshot shows the IPv6 configuration page. At the top, there are 'Cancel' and 'Apply' buttons. Below that, the 'Internet Connection Type' is set to 'Fixed'. The 'WAN Setup' section includes fields for 'IPv6 Address/Prefix Length', 'Default IPv6 Gateway', 'Primary DNS Server', and 'Secondary DNS Server'. The 'LAN Setup' section has radio buttons for 'IP Address Assignment' (with 'Use DHCP Server' selected) and 'Auto Config'. At the bottom, there is a field for 'IPv6 Address/Prefix Length' and a 'Secure' checkbox.

6. Configure the fixed IPv6 addresses for the WAN connection:
 - **IPv6 Address/Prefix Length.** The IPv6 address and prefix length of the router WAN interface.
 - **Default IPv6 Gateway.** The IPv6 address of the default IPv6 gateway for the router's WAN interface.
 - **Primary DNS Server.** The primary DNS server that resolves IPv6 domain name records for the router.
 - **Secondary DNS Server.** The secondary DNS server that resolves IPv6 domain name records for the router.

Note If you do not specify the DNS servers, the router uses the DNS servers that are configured for the IPv4 Internet connection on the Internet Setup page. (See *Manually Set Up the Internet Connection* on page 25.)

7. Select an IP Address Assignment radio button:

- **Use DHCP Server.** This method passes more information to LAN devices but some IPv6 systems might not support the DHCPv6 client function.
- **Auto Config.** This is the default setting.

This setting specifies how the router assigns IPv6 addresses to the devices on your home network (the LAN).

8. In the **IPv6 Address/Prefix Length** fields, specify the static IPv6 address and prefix length of the router's LAN interface.

If you do not specify an ID here, the router generates one automatically from its MAC address.

9. Click the **Apply** button.

Your settings are saved.

Set Up an IPv6 DHCP Internet Connection

► **To set up an IPv6 Internet connection with a DHCP server:**

1. Launch a web browser from a computer or WiFi device that is connected to the network.
2. Type **http://www.routerlogin.net**.

A login window opens.

3. Enter the router user name and password.

The user name is **admin**. The default password is **password**. The user name and password are case-sensitive.

The BASIC Home page displays.

4. Select **ADVANCED > Advanced Setup > IPv6**.

The IPv6 page displays.

Nighthawk X4S AC2600 Smart WiFi Router

- From the **Internet Connection Type** menu, select **DHCP**.

The screenshot shows the IPv6 configuration interface. At the top, there are buttons for 'Status Refresh', 'Cancel', and 'Apply'. The 'Internet Connection Type' is set to 'DHCP'. Below this, there are fields for 'User Class (If Required)', 'Domain Name (If Required)', and 'Router's IPv6 Address On WAN' (displaying 'Not Available'). The 'LAN Setup' section includes 'Router's IPv6 Address On LAN' (displaying 'Not Available'), 'IP Address Assignment' with radio buttons for 'Use DHCP Server' and 'Auto Config' (selected), and a 'Use This Interface ID' checkbox with a dropdown menu. At the bottom, there is an 'IPv6 Filtering' section with 'Secured' and 'Open' options.

The router automatically detects the information in the following fields:

- **Router's IPv6 Address on WAN.** This field shows the IPv6 address that is acquired for the router's WAN (or Internet) interface. The number after the slash (/) is the length of the prefix, which is also indicated by the underline () under the IPv6 address. If no address is acquired, the field displays Not Available.
- **Router's IPv6 Address on LAN.** This field shows the IPv6 address that is acquired for the router's LAN interface. The number after the slash (/) is the length of the prefix, which is also indicated by the underline () under the IPv6 address. If no address is acquired, the field displays Not Available.

- (Optional) In the **User Class (If Required)** field, enter a host name.

Most people can leave this field blank, but if your ISP gave you a specific host name, enter it here.

- (Optional) In the **Domain Name (If Required)** field, enter a domain name.

You can type the domain name of your IPv6 ISP. Do not enter the domain name for the IPv4 ISP here. For example, if your ISP's mail server is mail.xxx.yyy.zzz, type xxx.yyy.zzz as the domain name. If your ISP provided a domain name, type it in this field. For example, Earthlink Cable might require a host name of home, and Comcast sometimes supplies a domain name.

- Select an IP Address Assignment radio button:

- **Use DHCP Server.** This method passes more information to LAN devices but some IPv6 systems might not support the DHCv6 client function.
- **Auto Config.** This is the default setting.

This setting specifies how the router assigns IPv6 addresses to the devices on your home network (the LAN).

- (Optional) Select the **Use This Interface ID** check box and specify the interface ID to be used for the IPv6 address of the router's LAN interface.

Specify Your Internet Settings

If you do not specify an ID here, the router generates one automatically from its MAC address.

10. Click the **Apply** button.

Your settings are saved.

Set Up an IPv6 PPPoE Internet Connection

► To set up a PPPoE IPv6 Internet connection:

1. Launch a web browser from a computer or WiFi device that is connected to the network.
2. Type **http://www.routerlogin.net**.

A login window opens.

3. Enter the router user name and password.

The user name is **admin**. The default password is **password**. The user name and password are case-sensitive.

The BASIC Home page displays.

4. Select **ADVANCED > Advanced Setup > IPv6**.

The IPv6 page displays.

5. From the **Internet Connection Type** menu, select **PPPoE**.

The screenshot shows the IPv6 configuration page. The 'Internet Connection Type' is set to 'PPPoE'. The 'Login' and 'Password' fields are empty. The 'Service Name (if Required)' field is empty. The 'Connection Mode' dropdown is set to 'Always On'. The 'Router's IPv6 Address On WAN' is 'Not Available'. The 'LAN Setup' section shows the 'Router's IPv6 Address On LAN' is 'Not Available'. The 'IP Address Assignment' section has 'Use DHCP Server' and 'Auto Config' options, with 'Auto Config' selected. There is a checkbox for 'Use This Interface ID' with a dropdown menu below it. At the bottom, there is an 'IPv6 Filtering' section with 'Secured' and 'Open' radio buttons, where 'Secured' is selected.

The router automatically detects the information in the following fields:

Nighthawk X4S AC2600 Smart WiFi Router

- **Router's IPv6 Address on WAN.** This field shows the IPv6 address that is acquired for the router's WAN (or Internet) interface. The number after the slash (/) is the length of the prefix, which is also indicated by the underline (_) under the IPv6 address. If no address is acquired, the field displays Not Available.
- **Router's IPv6 Address on LAN.** This field shows the IPv6 address that is acquired for the router's LAN interface. The number after the slash (/) is the length of the prefix, which is also indicated by the underline (_) under the IPv6 address. If no address is acquired, the field displays Not Available.

6. In the **Login** field, enter the login information for the ISP connection.

This is usually the name that you use in your email address. For example, if your main mail account is JerAB@ISP.com, you would type JerAB in this field. Some ISPs (like Mindspring, Earthlink, and T-DSL) require that you use your full email address when you log in. If your ISP requires your full email address, type it in this field.

7. In the **Password** field, enter the password for the ISP connection.
8. In the **Service Name** field, enter a service name.

If your ISP did not provide a service name, leave this field blank.

Note The default setting of the **Connection Mode** menu is **Always On** to provide a steady IPv6 connection. The router never terminates the connection. If the connection is terminated, for example, when the modem is turned off, the router attempts to reestablish the connection immediately after the PPPoE connection becomes available again.

9. Select an IP Address Assignment radio button:
 - **Use DHCP Server.** This method passes more information to LAN devices but some IPv6 systems might not support the DHCv6 client function.
 - **Auto Config.** This is the default setting.

This setting specifies how the router assigns IPv6 addresses to the devices on your home network (the LAN).

10. (Optional) Select the **Use This Interface ID** check box and specify the interface ID to be used for the IPv6 address of the router's LAN interface.

If you do not specify an ID here, the router generates one automatically from its MAC address.

11. Click the **Apply** button.

Your settings are saved.

Change the MTU Size

The maximum transmission unit (MTU) is the largest data packet a network device transmits. When one network device communicates across the Internet with another, the data packets travel through many devices along the way.

Nighthawk X4S AC2600 Smart WiFi Router

If a device in the data path uses a lower MTU setting than the other devices, the data packets must be split or “fragmented” to accommodate the device with the smallest MTU.

The best MTU setting for NETGEAR equipment is often the default value. In some situations, changing the value fixes one problem but causes another. Leave the MTU unchanged unless one of these situations occurs:

- You experience problems connecting to your ISP or other Internet service, and the technical support of either the ISP or NETGEAR recommends changing the MTU setting. These web-based applications might require an MTU change:
 - A secure website that does not open, or displays only part of a web page
 - Yahoo email
 - MSN portal
 - America Online’s DSL service
- You use VPN and experience severe performance problems.
- You used a program to optimize MTU for performance reasons and now you are experiencing connectivity or performance problems.

Note An incorrect MTU setting can cause Internet communication problems. For example, you might not be able to access certain websites, frames within websites, secure login pages, or FTP or POP servers.

▶ To change the MTU size:

1. Launch a web browser from a computer or WiFi device that is connected to the network.
2. Type **http://www.routerlogin.net**.

A login window opens.

3. Enter the router user name and password.

The user name is **admin**. The default password is **password**. The user name and password are case-sensitive.

The BASIC Home page displays.

Nighthawk X4S AC2600 Smart WiFi Router

4. Select **ADVANCED > Setup > WAN Setup**.

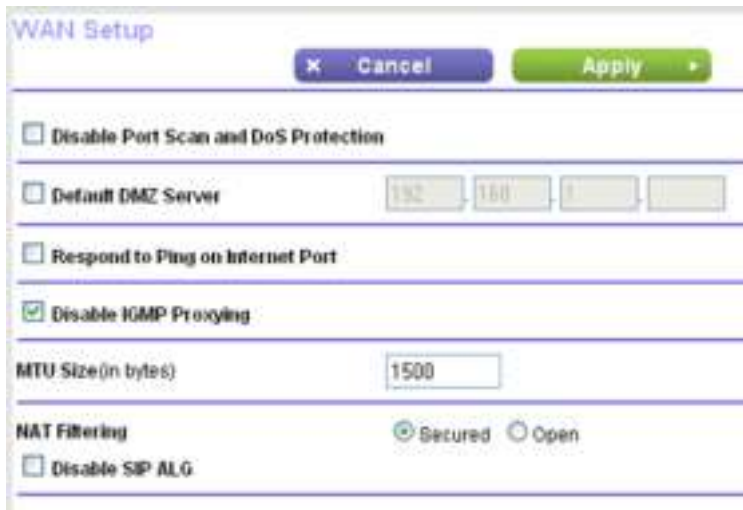

WAN Setup

Disable Port Scan and DoS Protection

Default DMZ Server

Respond to Ping on Internet Port

Disable IGMP Proxying

MTU Size (in bytes)

NAT Filtering Secured Open

Disable SIP ALG

5. In the **MTU Size** field, enter a value from 64 to 1500.
6. Click the **Apply** button.

Your settings are saved.

If you suspect an MTU problem, a common solution is to change the MTU to 1400. If you are willing to experiment, you can gradually reduce the MTU from the maximum value of 1500 until the problem goes away. The following table describes common MTU sizes and applications.

Table 2. Common MTU sizes

MTU	Application
1500	The largest Ethernet packet size. This setting is typical for connections that do not use PPPoE or VPN and is the default value for NETGEAR routers, adapters, and switches.
1492	Used in PPPoE environments.
1472	Maximum size to use for pinging. (Larger packets are fragmented.)
1468	Used in some DHCP environments.
1460	Usable by AOL if you do not send or receive large email attachments, for example.
1436	Used in PPTP environments or with VPN.

MTU	Application
1400	Maximum size for AOL DSL.
576	Typical value to connect to dial-up ISPs.

Enable British Telecom IGMP Proxy Support

You must use this feature only for British Telecom (BT) Internet Protocol television (IPTV) service. It might also work with TalkTalk IPTV service.

▶ To enable BT IGMP proxy support:

1. Launch a web browser from a computer or WiFi device that is connected to the network.
2. Type **http://www.routerlogin.net**.

A login window opens.

3. Enter the router user name and password.

The user name is **admin**. The default password is **password**. The user name and password are case-sensitive.

The BASIC Home page displays.

4. Select **ADVANCED > Setup > WAN Setup**.

The WAN Setup page displays.

5. Clear the **Disable ITMP Proxying** check box.
6. Select the **Support British Telecom (BT) IGMP Proxying** check box.
7. Click the **Apply** button.

Your settings are saved.

Control Access to the Internet

4

The router comes with a built-in firewall that helps protect your home network from unwanted intrusions from the Internet.

This chapter includes the following sections:

- *Set Up Parental Controls* on page 46
- *Allow or Block Access to Your Network* on page 47
- *Use Keywords to Block Internet Sites* on page 48
- *Manage Network Access Control Lists* on page 52
- *Schedule When to Block Internet Sites and Services* on page 53
- *Set Up Security Event Email Notifications* on page 55
- *Set Up IP-MAC Binding* on page 56

Set Up Parental Controls

The first time that you select **Parental Controls** from the BASIC Home page, your browser goes to the Live Parental Controls website, where you can learn more about Parental Controls and download the application.

After you set up and enable Parental Controls, you can change the web filtering level for each device on the network through the network map page on the genie app.

▶ To set up Parental Controls:

1. Launch a web browser from a computer or WiFi device that is connected to the network.
2. Enter **http://www.routerlogin.net**.

A login window opens.

3. Enter the router user name and password.

The user name is **admin**. The default password is **password**. The user name and password are case-sensitive.

The BASIC Home page displays.

4. Select **Parental Controls**.

The Live Parental Controls website displays.

5. Click the button for the app or version that you want to download and use.
6. Follow the onscreen instructions to download and install the genie app.
7. Open the genie app and select **Parental Controls**.

After installation, Live Parental Controls automatically starts.

8. Click the **Next** button, read the note, and click the **Next** button again.

Because Live Parental Controls uses free OpenDNS accounts, you are prompted to log in or create a free account.

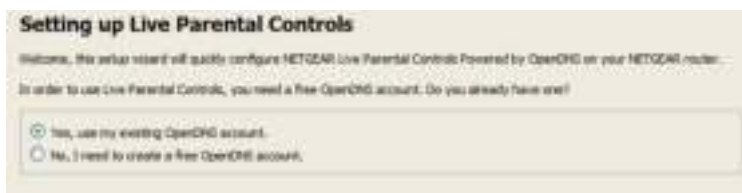

9. Select a radio button as follows:
 - If you already own an OpenDNS account, leave the **Yes** radio button selected.
 - If you do not own an OpenDNS account, select the **No** radio button.

If you are creating an account, the Create a free OpenDNS account page displays. Do the following:

Nighthawk X4S AC2600 Smart WiFi Router

- a. Complete the fields.
- b. Click the **Next** button.

After you log on or create your account, the filtering level page displays.

10. Select a filtering level and click the **Next** button.

The Setup is complete page displays.

11. Click the **Take me to the status screen** button.

The Status page displays. Parental controls are now set up for the router.

12. To enable Parental Controls, click the **Enable Live Parental Controls** button.

Allow or Block Access to Your Network

You can use access control to block or allow access to your network.

► To set up access control:

1. Launch a web browser from a computer or WiFi device that is connected to the network.
2. Enter **http://www.routerlogin.net**.

A login window opens.

3. Enter the router user name and password.

The user name is **admin**. The default password is **password**. The user name and password are case-sensitive.

The BASIC Home page displays.

4. Select **ADVANCED > Security > Access Control**.

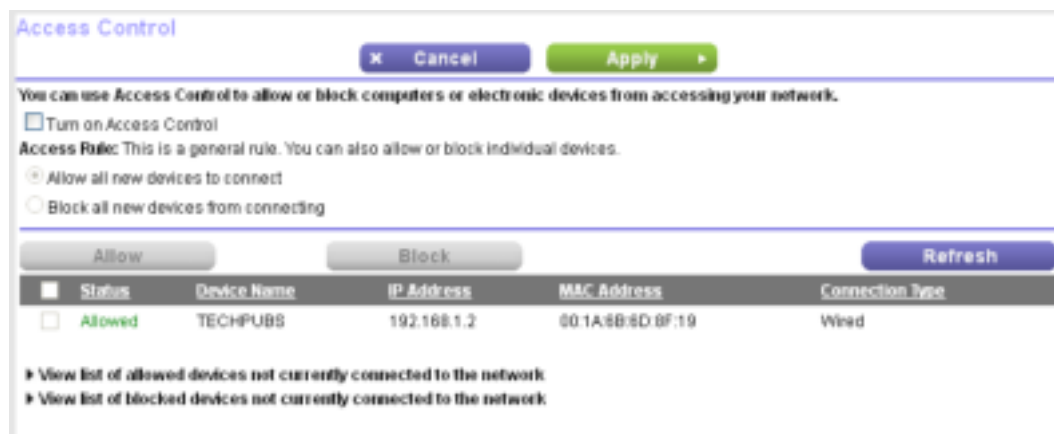

The screenshot shows the 'Access Control' configuration page. At the top, there are 'Cancel' and 'Apply' buttons. Below the title, a message states: 'You can use Access Control to allow or block computers or electronic devices from accessing your network.' There is a checkbox for 'Turn on Access Control'. Under 'Access Rule', there are two radio button options: 'Allow all new devices to connect' (selected) and 'Block all new devices from connecting'. Below these options are 'Allow' and 'Block' buttons, and a 'Refresh' button. A table displays the current status of devices:

Status	Device Name	IP Address	MAC Address	Connection Type
<input type="checkbox"/> Allowed	TECHPUBS	192.168.1.2	00:1A:5B:8D:0F:19	Wired

At the bottom, there are two links: 'View list of allowed devices not currently connected to the network' and 'View list of blocked devices not currently connected to the network'.

5. Select the **Turn on Access Control** check box.

Nighthawk X4S AC2600 Smart WiFi Router

You must select this check box before you can specify an access rule and use the **Allow** and **Block** buttons. When this check box is cleared, all devices are allowed to connect, even if a device is in the blocked list.

6. Select an access rule:
 - **Allow all new devices to connect.** With this setting, if you add a new device, it can access your network. You don't need to enter its MAC address on this page. We recommend that you leave this radio button selected.
 - **Block all new devices from connecting.** With this setting, if you add a new device, before it can access your network, you must enter its MAC address for an Ethernet connection and its MAC address for a WiFi connection in the allowed list.

The access rule does not affect previously blocked or allowed devices. It applies only to devices joining your network in the future after you apply these settings.

7. To view allowed or blocked devices that are not connected, click one of the following links:

- **View list of allowed devices not currently connected to the network**
- **View list of blocked devices not currently connected to the network**

The list displays.

8. To allow the computer or device you're currently using to continue to access the network, select the check box next to your computer or device, and click the **Allow** button.
9. Click the **Apply** button.

Your settings are saved.

Use Keywords to Block Internet Sites

You can use keywords to block certain Internet sites from your network. You can use blocking all the time or based on a schedule.

► To block Internet sites:

1. Launch a web browser from a computer or WiFi device that is connected to the network.
2. Enter **http://www.routerlogin.net**.
A login window opens.
3. Enter the router user name and password.
The user name is **admin**. The default password is **password**. The user name and password are case-sensitive.
The BASIC Home page displays.

4. Select **ADVANCED** > **Security** > **Block Sites**.



The screenshot shows the 'Block Sites' configuration page. At the top, there are 'Cancel' and 'Apply' buttons. Below that is a link: 'To learn more about advanced content filtering and keyword blocking features from NETGEAR, please go to www.netgear.com/na'. The 'Keyword Blocking' section has three radio button options: 'Event' (selected), 'Per Schedule', and 'Always'. Below this is a text input field labeled 'Type keyword or domain name here' with an 'Add Keyword' button. Underneath is a list area labeled 'Block sites containing these keywords or domain names:' with 'Delete Keyword' and 'Clear List' buttons. At the bottom, there is a checkbox for 'Allow trusted IP addresses to visit blocked sites' and a 'Trusted IP Address' field with 'Add', 'Remove', and 'Clear' buttons.

5. Select a keyword blocking option:
 - **Per Schedule.** Turn on keyword blocking according to a schedule that you set. (See [Schedule When to Block Internet Sites and Services](#) on page 53.)
 - **Always.** Turn on keyword blocking all the time, independent of the Schedule page.
6. In the **Type keyword or domain name here** field, enter a keyword or domain that you want to block. For example:
 - Specify XXX to block <http://www.badstuff.com/xxx.html>.
 - Specify .com if you want to allow only sites with domain suffixes such as .edu or .gov.
 - Enter a period (.) to block all Internet browsing access.
7. Click the **Add Keyword** button.
The keyword is added to the keyword list. The keyword list supports up to 32 entries.
8. Click the **Apply** button.
Keyword blocking takes effect.

Block Services From the Internet

You can block Internet services on your network based on the type of service. You can block the services all the time or based on a schedule.

▶ To block services:

1. Launch a web browser from a computer or WiFi device that is connected to the network.
2. Enter **<http://www.routerlogin.net>**.

A login window opens.

Nighthawk X4S AC2600 Smart WiFi Router

3. Enter the router user name and password.

The user name is **admin**. The default password is **password**. The user name and password are case-sensitive. The BASIC Home page displays.

4. Select **ADVANCED > Security > Block Services**.



5. Specify when to block the services:

- To block the services all the time, select the **Always** radio button.
- To block the services based on a schedule, select the **Per Schedule** radio button.

For information about how to specify the schedule, see [Schedule When to Block Internet Sites and Services](#) on page 53.

6. Click the **Add** button.



7. To add a service that is in the **Service Type** menu, select the application or service.

The settings for this service automatically display in the fields.

8. To add a service or application that is not in the menu, select **User Defined**, and do the following:

- a. If you know that the application uses either TCP or UDP, select the appropriate protocol. Otherwise, select **TCP/UDP** (both).
- b. Enter the starting port and ending port numbers.

If the service uses a single port number, enter that number in both fields. To find out which port numbers the service or application uses, you can contact the publisher of the application, ask user groups or newsgroups, or search on the Internet.

9. Select a filtering option:
 - **Only This IP Address.** Block services for a single computer.
 - **IP Address Range.** Block services for a range of computers with consecutive IP addresses on your network.
 - **All IP Addresses.** Block services for all computers on your network.

10. Click the **Add** button.

Your settings are saved.

Delete Keywords From the Blocked List

► To delete keywords from the list:

1. Launch a web browser from a computer or WiFi device that is connected to the network.
2. Enter **http://www.routerlogin.net**.

A login window opens.

3. Enter the router user name and password.

The user name is **admin**. The default password is **admin**. The user name and password are case-sensitive.

The BASIC Home page displays.

4. Select **ADVANCED > Security > Block Sites**.

The Block Sites page displays.

5. Do one of the following:

- To delete a single word, select it and click the **Delete Keyword** button.
The keyword is removed from the list.
- To delete all keywords on the list, click the **Clear List** button.
All keywords are removed from the list.

6. Click the **Apply** button.

Your settings are saved.

Avoid Blocking on a Trusted Computer

You can exempt one trusted computer from blocking. The computer that you exempt must be assigned a fixed IP address. You can use the reserved IP address feature to specify the IP address. See *Manage Reserved LAN IP Addresses* on page 64.

► To specify a trusted computer:

1. Launch a web browser from a computer or WiFi device that is connected to the network.
2. Enter **http://www.routerlogin.net**.
A login window opens.
3. Enter the router user name and password.
The user name is **admin**. The default password is **password**. The user name and password are case-sensitive.
The BASIC Home page displays.
4. Select **ADVANCED > Security > Block Sites**.
The Block Sites page displays.
5. Scroll down and select the **Allow trusted IP address to visit blocked sites** check box.
6. In the **Trusted IP Address** field, enter the IP address of the trusted computer.
7. Click the **Apply** button.
Your settings are saved.

Manage Network Access Control Lists

You can use access control to block or allow access to your network.

► To manage devices that are allowed or blocked:

1. Launch a web browser from a computer or WiFi device that is connected to the network.
2. Type **http://www.routerlogin.net**.
A login window opens.
3. Enter the router user name and password.
The user name is **admin**. The default password is **password**. The user name and password are case-sensitive.
The BASIC Home page displays.

4. Select **ADVANCED > Security > Access Control**.

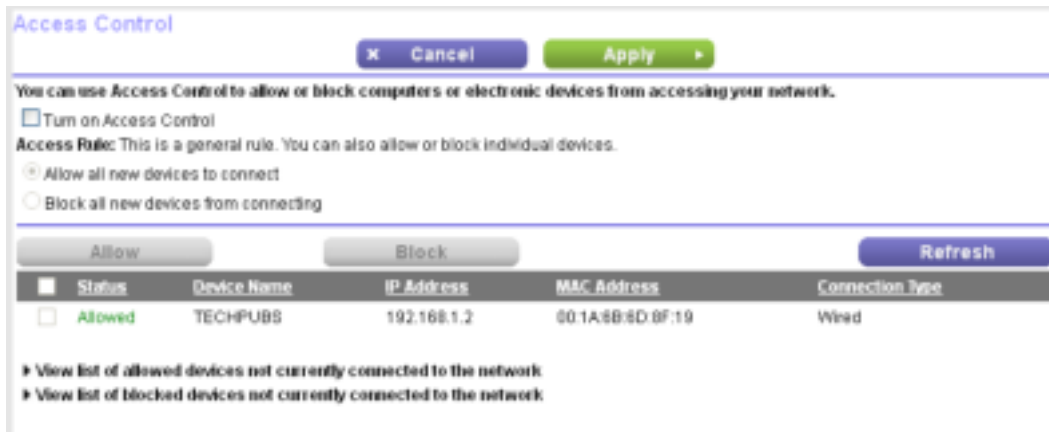

5. Select the **Turn on Access Control** radio button.
6. Click the **View list of allowed devices not currently connected to the network** link.

The list displays.

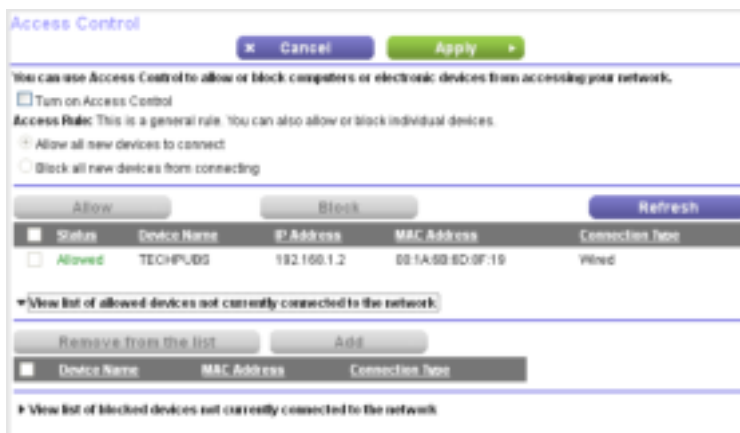

7. Select the check box for a device.
8. Use the **Add** button, **Edit** button, and **Remove from the list** button as needed.
9. Click the **Apply** button.

Your changes take effect.

Schedule When to Block Internet Sites and Services

When you schedule blocking, the same schedule is used to block sites and to block services. For information about how to specify what you want the router to block, see [Use Keywords to Block Internet Sites](#) on page 48 and [Block Services From the Internet](#) on page 49.

► To schedule blocking:

1. Launch a web browser from a computer or WiFi device that is connected to the network.
2. Enter **http://www.routerlogin.net**.

A login window opens.

3. Enter the router user name and password.

The user name is **admin**. The default password is **password**. The user name and password are case-sensitive.

The BASIC Home page displays.

4. Select **ADVANCED > Security > Schedule**.



The screenshot shows the 'Schedule' configuration page. At the top, there are 'Cancel' and 'Apply' buttons. Below that, the 'Days to Block' section has radio buttons for 'Every Day' (selected), 'Sunday', 'Monday', 'Tuesday', 'Wednesday', 'Thursday', 'Friday', and 'Saturday'. The 'Time of day to block (in 24-hour clock)' section has radio buttons for 'All Day' (selected), and input fields for 'Start Blocking' and 'End Blocking' with 'Hour' and 'Minute' sub-labels. The 'Time Zone' section has a dropdown menu set to '(GMT-08:00) Pacific Time (US & Canada) Tijuana' and a checkbox for 'Automatically adjust for daylight savings time'. At the bottom, it shows 'Current Time: Wednesday, Dec 11, 2012 17:04:26'.

5. Specify when to block keywords and services:
 - **Days to Block**. Select the check box for each day that you want to block the keywords, or select the **Every Day** check box, which automatically selects the check boxes for all days.
 - **Time of Day to Block**. Select a start and end time in 24-hour format, or select the **All Day** check box for 24-hour blocking.
6. Select your time zone from the menu.
7. If you live in a region that observes daylight saving time, select the **Automatically adjust for daylight savings time** check box.
8. Click the **Apply** button.

Your settings are saved.

Set Up Security Event Email Notifications

The router can email you its logs of router activity. The log records router activity and security events such as attempts to access blocked sites or services.

► To set up email notifications:

1. Launch a web browser from a computer or WiFi device that is connected to the network.
2. Enter **http://www.routerlogin.net**.

A login window opens.

3. Enter the router user name and password.

The user name is **admin**. The default password is **password**. The user name and password are case-sensitive.

The BASIC Home page displays.

4. Select **ADVANCED > Security > E-mail**.

5. Select the **Turn E-mail Notification On** check box.
6. In the **Your Outgoing Mail Server** field, enter the name of your ISP outgoing (SMTP) mail server (such as mail.myISP.com).

You might be able to find this information in the configuration window of your email program. If you leave this field blank, log and alert messages are not sent.

7. In the **Send to This E-mail Address** field, type the email address to which logs and alerts are to be sent.

This email address is also used for the From address. If this field is blank, log and alert messages are not sent.

8. If your outgoing email server requires authentication, select the **My Mail Server requires authentication** check box, and do the following:

- a. In the **User Name** field, type the user name for the outgoing email server.
 - b. In the **Password** field, type the password for the outgoing email server.
9. To send alerts when someone attempts to visit a blocked site, select the **Send Alerts Immediately** check box.
Email alerts are sent immediately when someone attempts to visit a blocked site.
10. To send logs based on a schedule, specify these settings:
 - a. From **Send logs according to this schedule** menu, select the schedule type.
 - b. From the **Day** menu, select the day.
 - c. From the **Time** menu, select the time, and select the **am** or **pm** radio button.
11. Click the **Apply** button.

Your settings are saved.

Logs are sent automatically according to the schedule that you set. If the log fills before the specified time, it is sent. After the log is sent, it is cleared from the router memory. If the router cannot email the log and the log buffer fills, the router overwrites the log.

Set Up IP-MAC Binding

This feature is available only in the China and Russia regions.

► To set IP-MAC binding:

1. Launch a web browser from a computer or WiFi device that is connected to the network.
2. Enter **http://www.routerlogin.net**.

A login window opens.

3. Enter the router user name and password.

The user name is **admin**. The default password is **password**. The user name and password are case-sensitive.

The BASIC Home page displays.

4. Select **ADVANCED > Security > ARP Protection/IPMAC Binding**.

The ARP Protection/IPMAC Binding page displays. By default, the IP-MAC binding feature is turned off.

5. To turn on this feature, select the **Enable** check box.
6. Click the **Apply** button.

The IP address reservation table becomes the IPMAC binding table. The router is set to use a static ARP table for the LAN environment and no longer receives ARP replies from LAN ports. Internet access is granted only to LAN devices that are registered in the IP binding table.

Network Settings

5

The router comes ready for WiFi, Ethernet, and USB connections. You can customize the router's network settings. We recommend that you install the router and connect it to the Internet before you change its network settings.

This chapter includes the following sections:

- [View or Change WAN Settings](#) on page 58
- [Set Up a Default DMZ Server](#) on page 59
- [Change the Router's Device Name](#) on page 60
- [Change the LAN TCP/IP Settings](#) on page 60
- [Specify the IP Addresses That the Router Assigns](#) on page 62
- [Disable the DHCP Server Feature in the Router](#) on page 64
- [Manage Reserved LAN IP Addresses](#) on page 64
- [Use the WPS Wizard for WiFi Connections](#) on page 66
- [Specify Basic WiFi Settings](#) on page 67
- [Change the WiFi Password or Security Level](#) on page 71
- [Set Up a WiFi Schedule](#) on page 77
- [Enable or Disable WiFi 160 MHz](#) on page 72
- [Enable a WiFi Video Network](#) on page 72
- [Set Up a Guest WiFi Network](#) on page 73
- [Enable a WiFi Video Network](#) on page 72
- [Control the WiFi Radios](#) on page 76
- [Set Up a WiFi Schedule](#) on page 77
- [Specify WPS Settings](#) on page 78
- [Use the Router as a WiFi Access Point](#) on page 79
- [Use the Router in Bridge Mode](#) on page 80
- [Set Up a Bridge for a Port Group or VLAN Tag Group](#) on page 82

View or Change WAN Settings

You can view or configure wide area network (WAN) settings for the Internet port. You can set up a DMZ (demilitarized zone) server, change the maximum transmit unit (MTU) size, and enable the router to respond to a ping to its WAN (Internet) port.

► To view or change the WAN settings:

1. Launch a web browser from a computer or WiFi device that is connected to the network.
2. Type **http://www.routerlogin.net**.

A login window opens.

3. Enter the router user name and password.

The user name is **admin**. The default password is **password**. The user name and password are case-sensitive.

The BASIC Home page displays.

4. Select **ADVANCED > Setup > WAN Setup**.



The following settings display:

- **Disable Port Scan and DoS Protection.** DoS protection protects your LAN against denial of service attacks such as Syn flood, Smurf Attack, Ping of Death, and many others. Select this check box only in special circumstances.
- **Default DMZ Server.** This feature is sometimes helpful when you are playing online games or videoconferencing, but it makes the firewall security less effective. See [Set Up a Default DMZ Server](#) on page 59.
- **Respond to Ping on Internet Port.** This feature allows your router to be discovered. Use this feature only as a diagnostic tool or for a specific reason.

- **Disable IGMP Proxying.** IGMP proxying allows a computer on the local area network (LAN) to receive the multicast traffic it is interested in from the Internet. If you do not need this feature, you can select this check box to disable it.
- **MTU Size (in bytes).** The normal MTU (maximum transmit unit) value for most Ethernet networks is 1500 bytes, or 1492 bytes for PPPoE connections. Change the MTU only if you are sure that it is necessary for your ISP connection. See *Change the MTU Size* on page 41.
- **NAT Filtering.** Network Address Translation (NAT) determines how the router processes inbound traffic. Secured NAT protects computers on the LAN from attacks from the Internet but might prevent some Internet games, point-to-point applications, or multimedia applications from working. Open NAT provides a much less secured firewall but allows almost all Internet applications to work.

5. Click the **Apply** button.

Your changes are saved.

Set Up a Default DMZ Server

The default DMZ server feature is helpful when you are using some online games and videoconferencing applications that are incompatible with Network Address Translation (NAT). The router is programmed to recognize some of these applications and to work correctly with them, but other applications might not function well. In some cases, one local computer can run the application correctly if the IP address for that computer is entered as the default DMZ server.



WARNING:

DMZ servers pose a security risk. A computer designated as the default DMZ server loses much of the protection of the firewall and is exposed to exploits from the Internet. If compromised, the DMZ server computer can be used to attack other computers on your network.

The router usually detects and discards incoming traffic from the Internet that is not a response to one of your local computers or a service that you configured on the Port Forwarding/Port Triggering page. Instead of discarding this traffic, you can specify that the router forwards the traffic to one computer on your network. This computer is called the default DMZ server.

▶ To set up a default DMZ server:

1. Launch a web browser from a computer or WiFi device that is connected to the network.
2. Type **http://www.routerlogin.net**.

A login window opens.

3. Enter the router user name and password.

The user name is **admin**. The default password is **password**. The user name and password are case-sensitive.

The BASIC Home page displays.

4. Select **ADVANCED > Setup > WAN Setup**.

The WAN Setup page displays.

5. Select the **Default DMZ Server** check box.
6. Type the IP address.
7. Click the **Apply** button.

Your change takes effect.

Change the Router's Device Name

The router's default device name is based on its model number, such as R7500 or R7800. This device name displays in the file manager when you browse your network.

► To change the router's device name:

1. Launch a web browser from a computer or WiFi device that is connected to the network.
2. Type **http://www.routerlogin.net**.

A login window opens.

3. Enter the router user name and password.

The user name is **admin**. The default password is **password**. The user name and password are case-sensitive.

The BASIC Home page displays.

4. Select **ADVANCED > Setup > LAN Setup**.

The LAN Setup page displays.

5. In the **Device Name** field, type a new name.
6. Click the **Apply** button.

Your change is saved.

Change the LAN TCP/IP Settings

The router is preconfigured to use private IP addresses on the LAN side and to act as a DHCP server. The router's default LAN IP configuration is as follows:

- **LAN IP address.** 192.168.1.1
- **Subnet mask.** 255.255.255.0

These addresses are part of the designated private address range for use in private networks and are suitable for most applications. If your network requires a different IP addressing scheme, you can change these settings.

Nighthawk X4S AC2600 Smart WiFi Router

You might want to change these settings if you need a specific IP subnet that one or more devices on the network use, or if you use competing subnets with the same IP scheme.

▶ To change the LAN TCP/IP settings:

1. Launch a web browser from a computer or WiFi device that is connected to the network.
2. Type **http://www.routerlogin.net**.

A login window opens.

3. Enter the router user name and password.

The user name is **admin**. The default password is **password**. The user name and password are case-sensitive.

The BASIC Home page displays.

4. Select **ADVANCED > Setup > LAN Setup**.

The screenshot shows the 'LAN Setup' configuration page. At the top, there are 'Cancel' and 'Apply' buttons. The 'Device Name' field contains 'R7800'. Under 'LAN TCP/IP Setup', the 'IP Address' is '192.168.1.1' and the 'IP Subnet Mask' is '255.255.255.0'. The 'RIP Direction' is set to 'Both' and the 'RIP Version' is 'Disabled'. There is a checked checkbox for 'Use Router as DHCP Server'. Below it, the 'Starting IP Address' is '192.168.1.2' and the 'Ending IP Address' is '192.168.1.254'. At the bottom, there is an 'Address Reservation' table with columns for IP Address, Device Name, and MAC Address, and buttons for Add, Edit, and Delete.

Your router might display information that is different from this example.

5. In the **IP Address** field, type the IP address.
6. In the **IP Subnet Mask**, type the subnet mask of the router.

The IP address and subnet mask identify which addresses are local to a specific device and which must be reached through a gateway or router.

7. Change the RIP settings.

Router Information Protocol (RIP) allows a router to exchange routing information with other routers.

Nighthawk X4S AC2600 Smart WiFi Router

- a. Select the RIP direction:
 - **Both**. The router broadcasts its routing table periodically and incorporates information that it receives.
 - **Out Only**. The router broadcasts its routing table periodically.
 - **In Only**. The router incorporates the RIP information that it receives.
- b. Select the RIP version:
 - **Disabled**. This is the default setting.
 - **RIP-1**. This format is universally supported. It is adequate for most networks, unless you are using an unusual network setup.
 - **RIP-2**. This format carries more information. Both RIP-2B and RIP-2M send the routing data in RIP-2 format. RIP-2B uses subnet broadcasting. RIP-2M uses multicasting.

8. Click the **Apply** button.

Your changes are saved.

If you changed the LAN IP address of the router, you are disconnected when this change takes effect.

9. To reconnect, close your browser, relaunch it, and log in to the router.

Specify the IP Addresses That the Router Assigns

By default, the router acts as a Dynamic Host Configuration Protocol (DHCP) server. The router assigns IP, DNS server, and default gateway addresses to all computers connected to the LAN. The assigned default gateway address is the LAN address of the router.

These addresses must be part of the same IP address subnet as the router's LAN IP address. Using the default addressing scheme, define a range between 192.168.1.2 and 192.168.1.254, although you can save part of the range for devices with fixed addresses.

► To specify the pool of IP addresses that the router assigns:

1. Launch a web browser from a computer or WiFi device that is connected to the network.
2. Type **http://www.routerlogin.net**.

A login window opens.

3. Enter the router user name and password.

The user name is **admin**. The default password is **password**. The user name and password are case-sensitive.

The BASIC Home page displays.

Nighthawk X4S AC2600 Smart WiFi Router

4. Select **ADVANCED > Setup > LAN Setup**.

The screenshot shows the LAN Setup configuration interface. At the top, there are 'Cancel' and 'Apply' buttons. The 'Device Name' field is set to 'R7800'. Under 'LAN TCP/IP Setup', the IP Address is '192.168.1.1' and the IP Subnet Mask is '255.255.255.0'. The RIP Direction is set to 'Both' and the RIP Version is 'Disabled'. The 'Use Router as DHCP Server' checkbox is checked. The Starting IP Address is '192.168.1.2' and the Ending IP Address is '192.168.1.254'. Below this is an 'Address Reservation' table with columns for '#', 'IP Address', 'Device Name', and 'MAC Address'. At the bottom of the table are 'Add', 'Edit', and 'Delete' buttons.

Your router might display information that is different from this example.

5. Make sure that the **Use Router as DHCP Server** check box is selected.
6. Specify the range of IP addresses that the router assigns:
 - a. In the **Starting IP Address** field, type the lowest number in the range.

This IP address must be in the same subnet as the router.
 - b. In the **Ending IP Address** field, type the number at the end of the range of IP addresses.

This IP address must be in the same subnet as the router.
7. Click the **Apply** button.

Your settings are saved.

The router delivers the following parameters to any LAN device that requests DHCP:

- An IP address from the range that you define
- Subnet mask
- Gateway IP address (the router's LAN IP address)
- DNS server IP address (the router's LAN IP address)

Disable the DHCP Server Feature in the Router

By default, the router acts as a DHCP server. The router assigns IP, DNS server, and default gateway addresses to all computers connected to the LAN. The assigned default gateway address is the LAN address of the router.

You can use another device on your network as the DHCP server or specify the network settings of all your computers.

▶ To disable the DHCP server feature in the router:

1. Launch a web browser from a computer or WiFi device that is connected to the network.
2. Type **http://www.routerlogin.net**.
A login window opens.
3. Enter the router user name and password.
The user name is **admin**. The default password is **password**. The user name and password are case-sensitive.
The BASIC Home page displays.
4. Select **ADVANCED > Setup > LAN Setup**.
The LAN Setup page displays.
5. Clear the **Use Router as DHCP Server** check box.
6. Click the **Apply** button.
Your settings are saved.
7. (Optional) If this service is disabled and no other DHCP server is on your network, set your computer IP addresses manually so that the computers can access the router.

Manage Reserved LAN IP Addresses

When you specify a reserved IP address for a computer on the LAN, that computer always receives the same IP address each time it accesses the router's DHCP server. Assign reserved IP addresses to computers or servers that require permanent IP settings.

Reserve an IP Address

▶ To reserve an IP address:

1. Launch a web browser from a computer or WiFi device that is connected to the network.
2. Type **http://www.routerlogin.net**.
A login window opens.
3. Enter the router user name and password.
The user name is **admin**. The default password is **password**. The user name and password are case-sensitive.

The BASIC Home page displays.

4. Select **ADVANCED > Setup > LAN Setup**.

The LAN Setup page displays.

5. In the Address Reservation section, click the **Add** button.
6. In the **IP Address** field, type the IP address to assign to the computer or server.

Choose an IP address from the router's LAN subnet, such as 192.168.1.x.

7. Type the MAC address of the computer or server.

Tip If the computer is already on your network, you can copy its MAC address from the Attached Devices page and paste it here.

8. Click the **Apply** button.

The reserved address is entered into the table.

The reserved address is not assigned until the next time the computer contacts the router's DHCP server. Reboot the computer, or access its IP configuration and force a DHCP release and renew.

Edit a Reserved IP Address

▶ To edit a reserved address entry:

1. Launch a web browser from a computer or WiFi device that is connected to the network.
2. Type **http://www.routerlogin.net**.

A login window opens.

3. Enter the router user name and password.

The user name is **admin**. The default password is **password**. The user name and password are case-sensitive.

The BASIC Home page displays.

4. Select **ADVANCED > Setup > LAN Setup**.

The LAN Setup page displays.

5. Select the radio button next to the reserved address.
6. Click the **Edit** button.
7. Change the settings.
8. Click the **Apply** button.

Your changes are saved.

Delete a Reserved IP Address Entry

► To delete a reserved address entry:

1. Launch a web browser from a computer or WiFi device that is connected to the network.
2. Type **http://www.routerlogin.net**.
A login window opens.
3. Enter the router user name and password.
The user name is **admin**. The default password is **password**. The user name and password are case-sensitive.
The BASIC Home page displays.
4. Select **ADVANCED > Setup > LAN Setup**.
The LAN Setup page displays.
5. Select the radio button next to the reserved address.
6. Click the **Delete** button.
The address is removed.

Use the WPS Wizard for WiFi Connections

The WPS Wizard helps you add a WiFi computer or device to your WiFi network without typing the WiFi password.

► To use the WPS Wizard:

1. Launch a web browser from a computer or WiFi device that is connected to the network.
2. Type **http://www.routerlogin.net**.
A login window opens.
3. Enter the router user name and password.
The user name is **admin**. The default password is **password**. The user name and password are case-sensitive.
The BASIC Home page displays.
4. Select **ADVANCED > WPS Wizard**.
A note explaining WPS displays.
5. Click the **Next** button.

The WPS page displays.

6. Select a setup method:
 - **Push button.** Click the **WPS** button on this screen.
 - **PIN Number.** The page adjusts. Enter the client security PIN and click the **Next** button.
7. Within two minutes, go to the client device and use its WPS software to connect to the WiFi network.

The WPS process automatically sets up your WiFi computer with the network password when it connects. The router WPS page displays a confirmation message.

Specify Basic WiFi Settings

The router comes with preset security. This means that the WiFi network name (SSID), network key (password), and security option (encryption protocol) are preset in the factory. You can find the preset SSID and password on the label on the router.

Note The preset SSID and password are uniquely generated for every device to protect and maximize your WiFi security.

We recommend that you do not change your preset security settings. If you change your preset security settings, make a note of the new settings and store it in a safe place where you can easily find it.

If your computer is connected with WiFi when you change the SSID or other WiFi security settings, you are disconnected when you click the **Apply** button. To avoid this problem, use a computer with a wired connection to access the router.

► To specify basic WiFi settings:

1. Launch a web browser from a computer or WiFi device that is connected to the network.
2. Type **http://www.routerlogin.net**.

A login window opens.

3. Enter the router user name and password.

The user name is **admin**. The default password is **password**. The user name and password are case-sensitive.

The BASIC Home page displays.

Nighthawk X4S AC2600 Smart WiFi Router

4. Select **Wireless**.



You can specify the settings for the 2.4 GHz band and for the 5 GHz band.

Your router might display information that is different from this example.

5. From the **Region** menu, select your region.

In some locations, you cannot change this setting.

6. To control the SSID broadcast, select or clear the **Enable SSID Broadcast** check box.

When this check box is selected, the router broadcasts its network name (SSID) so that it displays when you scan for local WiFi networks on your computer or WiFi device.

7. To change the network name (SSID), type a new name in the **Name (SSID)** field.

The name can be up to 32 characters long and it is case-sensitive. The default SSID is randomly generated and is on the label on the tower. If you change the name, make sure to write down the new name and keep it in a safe place.

8. To change the WiFi channel, select a number from the **Channel** menu.

In some regions, not all channels are available. Do not change the channel unless you experience interference (shown by lost connections or slow data transfers). If this happens, experiment with different channels to see which is the best.

When you use multiple access points, it is better if adjacent access points use different channels to reduce interference. The recommended channel spacing between adjacent access points is four channels (for example, use Channels 1 and 5, or 6 and 10).

9. Click the **Apply** button.

Your settings are saved.

If you connected wirelessly to the network and you changed the SSID, you are disconnected from the network.

10. Make sure that you can connect wirelessly to the network with its new settings.

If you cannot connect wirelessly, check the following:

Network Settings

Nighthawk X4S AC2600 Smart WiFi Router

- Is your computer or WiFi device connected to another WiFi network in your area? Some WiFi devices automatically connect to the first open network without WiFi security that they discover.
- Is your computer or WiFi device trying to connect to your network with its old settings (before you changed the settings)? If so, update the WiFi network selection in your computer or WiFi device to match the current settings for your network.

Change the WiFi Mbps Settings

The data rate for high-speed transmissions is commonly identified as megabits per second (Mbps). By default, the router is set to operate with up to 600 Mbps in the 2.4 GHz WiFi band and up to 1,733 Mbps in the 5 GHz WiFi band. You can select slower settings.

► To change the WiFi Mbps settings:

1. Launch a web browser from a computer or WiFi device that is connected to the network.
2. Type **http://www.routerlogin.net**.

A login window opens.

3. Enter the router user name and password.

The user name is **admin**. The default password is **password**. The user name and password are case-sensitive.

The BASIC Home page displays.

4. Select **Wireless**.



Your router might display information that is different from this example.

5. For the 2.4 GHz WiFi band, in the Wireless Network (2.4 GHz b/gn/n) section, select a setting from the **Mode** menu.

Up to 800 Mbps is the default setting. The other settings are **Up to 347 Mbps** and **Up to 54 Mbps**.

6. For the 5GHz WiFi band, select a setting from the **Mode** menu.

Up to 1733 Mbps is the default setting, which allows 802.11ac and 802.11a WiFi devices to join the network. The other settings are **Up to 800 Mbps** and **Up to 347 Mbps**.

When the **Enable 20/40 MHz Coexistence** check box is selected, the router runs in 40 MHz mode unless there is another nearby WiFi network in the area already running in 40 MHz mode or there is a WiFi access point on

the secondary channel. If that happens, the router runs in 20 MHz mode to coexist with that network. If you want the router to always run in 40 MHz mode, clear this check box.

7. Click the **Apply** button.

Your settings are saved.

Change the WiFi Password or Security Level

Your router comes with preset WPA2 or WPA security. The password that you enter to connect to your network is unique to your router and is on the label on the router. *We recommend that you use the preset security, but you can change the settings. Do not disable security.*

► To change the WPA settings:

1. Launch a web browser from a computer or WiFi device that is connected to the network.
2. Enter **http://www.routerlogin.net**.

A login window opens.

3. Enter the router user name and password.

The user name is **admin**. The default password is **password**. The user name and password are case-sensitive.

The BASIC Home page displays.

4. Select **Wireless**.

The Wireless Settings page displays.

5. Under Security Options, select a WPA option.

The WPA2 options use the newest standard for the strongest security. WPA2-PSK (AES) is the default setting.

The **Passphrase** field displays.

6. In the **Passphrase** field, enter the network key (password).

It is a text string from 8 to 63 characters.

7. Write down the new password and keep it in a secure place for future reference.

8. Click the **Apply** button.

Your settings are saved.

Enable or Disable WiFi 160 MHz

The WiFi 160 MHz setting reduces lag and improves streaming speed. Note that the WiFi clients must have 160 MHz support, and they must be connected to the 5 GHz WiFi network. You can enable or disable WiFi the HT160 setting.

If your computer is connected with WiFi when you change the MU-MIMO setting, you are disconnected when you click the **Apply** button. To avoid this problem, use a computer with a wired connection to access the router.

► To enable or disable WiFi 160 MHz:

1. Launch a web browser from a computer or WiFi device that is connected to the network.
2. Enter **http://www.routerlogin.net**.

A login window opens.

3. Enter the router user name and password.

The user name is **admin**. The default password is **password**. The user name and password are case-sensitive.

The BASIC Home page displays.

4. Select **ADVANCED > Advanced Setup > Wireless Settings**.

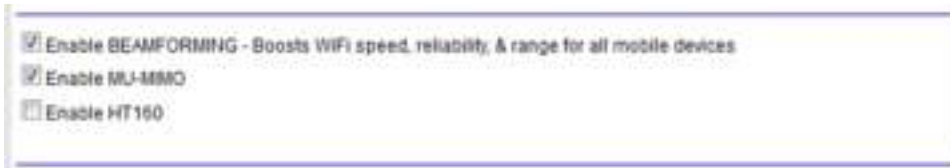

5. Select the **Enable HT160** check box.
6. Click the **Apply** button.

Your settings are saved.

Enable a WiFi Video Network

Guest networks allows visitors at your home to use the Internet without using your WiFi security key. For optimal HD streaming performance for your guests, you can enable a 5 GHz guest video network. When this the video network feature is enabled, the router uses video reliability algorithms to reduce jitter and packet loss during video streaming.

► To enable a WiFi video network:

1. Launch a web browser from a computer or WiFi device that is connected to the network.
2. Type **http://www.routerlogin.net**.

A login window opens.

3. Enter the router user name and password.

Nighthawk X4S AC2600 Smart WiFi Router

The user name is **admin**. The default password is **password**. The user name and password are case-sensitive.

The BASIC Home page displays.

4. Select **Wireless.**

The Wireless Setup page displays.

5. Scroll down to the Wireless Network (5 GHz 802.11a/n/ac) section of the page.

6. Select the **Enable Video Network check box.**

7. Click the **Apply button.**

Your settings are saved.

Set Up a Guest WiFi Network

Guest networks allow visitors at your home to use the Internet without using your WiFi security key. You can add a guest network for the 2.4 GHz WiFi band and the 5.0 GHz WiFi band.

► **To set up a guest network:**

1. Launch a web browser from a computer or WiFi device that is connected to the network.

2. Type **http://www.routerlogin.net.**

A login window opens.

3. Enter the router user name and password.

The user name is **admin**. The default password is **password**. The user name and password are case-sensitive.

The BASIC Home page displays.

4. Select **Guest Network**.

Guest Network Settings

Wireless Settings (2.4GHz band)

Enable Guest Network

Enable SSID Broadcast

Allow guests to see each other and access my local network

Guest Wireless Network Name (SSID):

Security Options

None

WPA2-PSK (AES)

WPA-PSK (TKIP) + WPA2-PSK (AES)

WPA/WPA2 Enterprise

Wireless Settings (5GHz 802.11n/ac)

Enable Guest Network

Enable SSID Broadcast

Enable Video Network

Allow guests to see each other and access my local network

Guest Wireless Network Name (SSID):

Security Options

None

WPA2-PSK (AES)

WPA-PSK (TKIP) + WPA2-PSK (AES)

Your router might display information that is different from this example.

5. Scroll to the section of the page for the guest WiFi network that you want to set up.

The default guest WiFi network names (SSIDs) are as follows:

- **NETGEAR-Guest** is for the 2.4 GHz WiFi band.
- **NETGEAR-5G-Guest** is for the 5 GHz WiFi band.

6. Leave the **Enable SSID Broadcast** check box selected.

Allowing the router to broadcast its WiFi network name (SSID) makes it easier to find your network and connect to it. If you clear this check box, that creates a hidden network.

7. Give the guest network a name.

The guest network name is case-sensitive and can be up to 32 characters. You then manually configure the WiFi devices in your network to use the guest network name in addition to the main SSID.

8. For the WiFi channel and mode, leave the default settings selected.

9. Select a security option.

The WPA2 options use the newest standard for the strongest security. WPA2 is the default setting.

10. Click the **Apply** button.

Your settings are saved.

Enable a Video Guest WiFi Network

Guest networks allow visitors at your home to use the Internet without using your WiFi security key. For optimal HD streaming performance for your guests, you can enable a 5 GHz guest video network. When this the video network feature is enabled, the router uses video reliability algorithms to reduce jitter and packet loss during video streaming.

► To set up a guest network:

1. Launch a web browser from a computer or WiFi device that is connected to the network.
2. Type **http://www.routerlogin.net**.

A login window opens.

3. Enter the router user name and password.

The user name is **admin**. The default password is **password**. The user name and password are case-sensitive.

The BASIC Home page displays.

4. Select **Guest Network**.

Guest Network Settings

Cancel Apply

Wireless Settings (2.4GHz 802.11n)

Enable Guest Network

Enable SSID Broadcast

Allow guests to see each other and access my local network

Guest Wireless Network Name (SSID): NETGEAR-Guest

Security Options

None

WPA2-PSK [AES]

WPA-PSK [TKIP] + WPA2-PSK [AES]

WPAWPA2 Enterprise

Wireless Settings (5GHz 802.11a/n/ac)

Enable Guest Network

Enable SSID Broadcast

Enable Video Network

Allow guests to see each other and access my local network

Guest Wireless Network Name (SSID): NETGEAR-5G-Guest

Security Options

None

WPA2-PSK [AES]

WPA-PSK [TKIP] + WPA2-PSK [AES]

Your router might display information that is different from this example.

5. Scroll to the Wireless Network (5 GHz 802.11 a/n/ac) section.
6. Select the **Enable Video Network** check box.
7. Click the **Apply** button.

Your settings are saved.

Control the WiFi Radios

The router's internal WiFi radios broadcast signals in the 2.4 GHz and 5 GHz ranges. By default, they are on so that you can connect over WiFi to the router. When the WiFi radios are off, you can still use an Ethernet cable for a LAN connection to the router.

You can turn the WiFi radios on and off with the **WiFi On/Off** button on the router, or you can log in to the router and enable or disable the WiFi radios. If you are close to the router, it might be easier to press its **WiFi On/Off** button. If you are away from the router or already logged in it might be easier to enable or disable them. You can also turn the WiFi radios off and on based on a schedule. (See *Set Up a WiFi Schedule* on page 77.)

Use the WiFi On/Off Button

► To turn the WiFi radios off and on with the WiFi On/Off button:

- Press the **WiFi On/Off** button on the top of the router for two seconds.

If you turned off the WiFi radios, the WiFi On/Off LED and the WPS LED turn off. If you turned on the WiFi radios, the WiFi On/Off LED and the WPS LED light.

Enable or Disable the WiFi Radios

If you used the **WiFi On/Off** button to turn off the WiFi radios, you can't log in to the router to turn them back on. You must press the **WiFi On/Off** button again for two seconds to turn the WiFi radios back on.

► To enable or disable the WiFi radios:

1. Launch a web browser from a computer or WiFi device that is connected to the network.
2. Enter **http://www.routerlogin.net**.

A login window opens.

3. Enter the router user name and password.

The user name is **admin**. The default password is **password**. The user name and password are case-sensitive.

The BASIC Home page displays.

4. Select **ADVANCED > Advanced Setup > Wireless Settings**.

Your router might display information that is different from this example.

5. In the 2.4 GHz and 5 GHz sections, select or clear the **Enable Wireless Router Radio** check boxes.
Clearing these check boxes turns off the WiFi feature of the router for each band.
6. Click the **Apply** button.

If you turned off both WiFi radios, the WiFi On/Off LED and the WPS LED turn off. If you turned on the WiFi radios, the WiFi On/Off LED and the WPS LED light.

Set Up a WiFi Schedule

You can turn off the WiFi signal from your router at times when you do not need a WiFi connection. For example, you might turn it off for the weekend if you leave town.

► To set up the WiFi schedule:

1. Launch a web browser from a computer or WiFi device that is connected to the network.
2. Enter **http://www.routerlogin.net**.

A login window opens.

3. Enter the router user name and password.

The user name is **admin**. The default password is **password**. The user name and password are case-sensitive.

The BASIC Home page displays.

4. Select **ADVANCED > Advanced Setup > Wireless Settings**.
5. Click the **Add a new period** button.
6. Use the menus, radio buttons, and check boxes to set up a period during which you want to turn off the WiFi signal.
7. Click the **Apply** button.
8. Select the **Turn off wireless signal by schedule** check box to activate the schedule.
9. Click the **Apply** button.

Your settings are saved.

Specify WPS Settings

Wi-Fi Protected Setup (WPS) lets you join the WiFi network without typing the WiFi password.

► To specify WPS settings:

1. Launch a web browser from a computer or WiFi device that is connected to the network.
2. Type **http://www.routerlogin.net**.

A login window opens.

3. Enter the router user name and password.

The user name is **admin**. The default password is **password**. The user name and password are case-sensitive.

The BASIC Home screen displays.

4. Select **ADVANCED > Advanced Setup > Wireless Settings**.

The Router's PIN field displays the PIN that you use on a registrar (for example, from the Network Explorer on a Vista Windows computer) to configure the router's WiFi settings through WPS.

5. (Optional) Select or clear the **Enable Router's PIN** check box.

The PIN function might temporarily be disabled when the router detects suspicious attempts to break into the router's WiFi settings by using the router's PIN through WPS. You can manually enable the PIN function by selecting the **Enable Router's PIN** check box.

6. (Optional) Select or clear the **Keep Existing Wireless Settings** check box.

By default, the **Keep Existing Wireless Settings** check box is selected. We recommend that you leave this check box selected.

Nighthawk X4S AC2600 Smart WiFi Router

If you clear this check box, the next time a new WiFi client uses WPS to connect to the router, the router WiFi settings change to an automatically generated random SSID and security key.

7. Click the **Apply** button.

Your changes are saved.

Use the Router as a WiFi Access Point

You can set up the router to run as an access point (AP) on the same local network as another router.

► To set up the router as an AP:

1. Use an Ethernet cable to connect the Internet port of this router to a LAN port in the other router.



2. Launch a web browser from a computer or WiFi device that is connected to the network.
3. Type **<http://www.routerlogin.net>**.

A login window opens.

4. Enter the router user name and password.

The user name is **admin**. The default password is **password**. The user name and password are case-sensitive.

The BASIC Home page displays.

5. Select **ADVANCED > Advanced Setup > Wireless AP**.

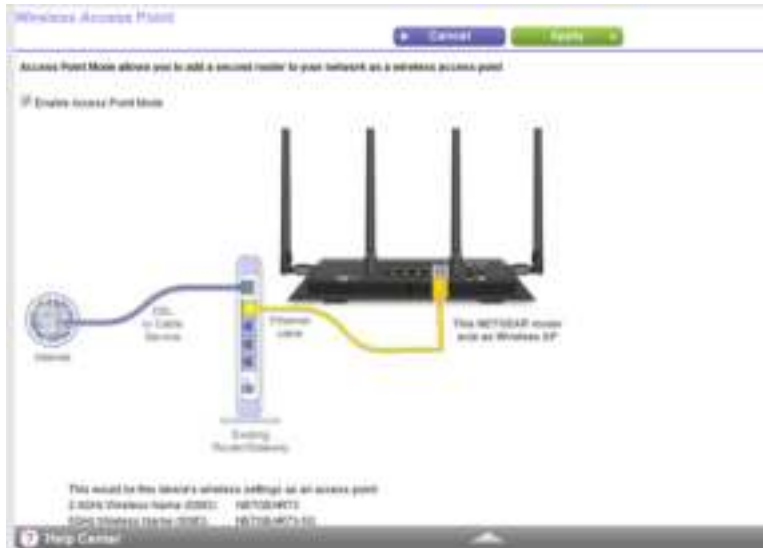

6. Select the **Enable AP Mode** check box.
7. Scroll down and select an IP address setting:
 - **Get dynamically from existing router.** The other router on the network assigns an IP address to this router while this router is in AP mode.
 - **Enable fixed IP settings on this device (not recommended).** Use this setting if you want to manually assign a specific IP address to this router while it is in AP mode. Using this option effectively requires advanced network experience.

Note To avoid interference with other routers or gateways in your network, NETGEAR recommends that you use different WiFi settings on each router. You can also turn off the WiFi radio on the other router or gateway and use the R7800 router only for WiFi client access.

8. Click the **Apply** button.
The IP address of the router changes, and you are disconnected.
9. To reconnect, close and restart your browser and type **http://www.routerlogin.net**.

Use the Router in Bridge Mode

You can use your router in bridge mode to connect multiple devices with WiFi at the faster 802.11ac speed. To do this, you need two WiFi routers: one set up as a router and the other set up as a bridge.

Nighthawk X4S AC2600 Smart WiFi Router

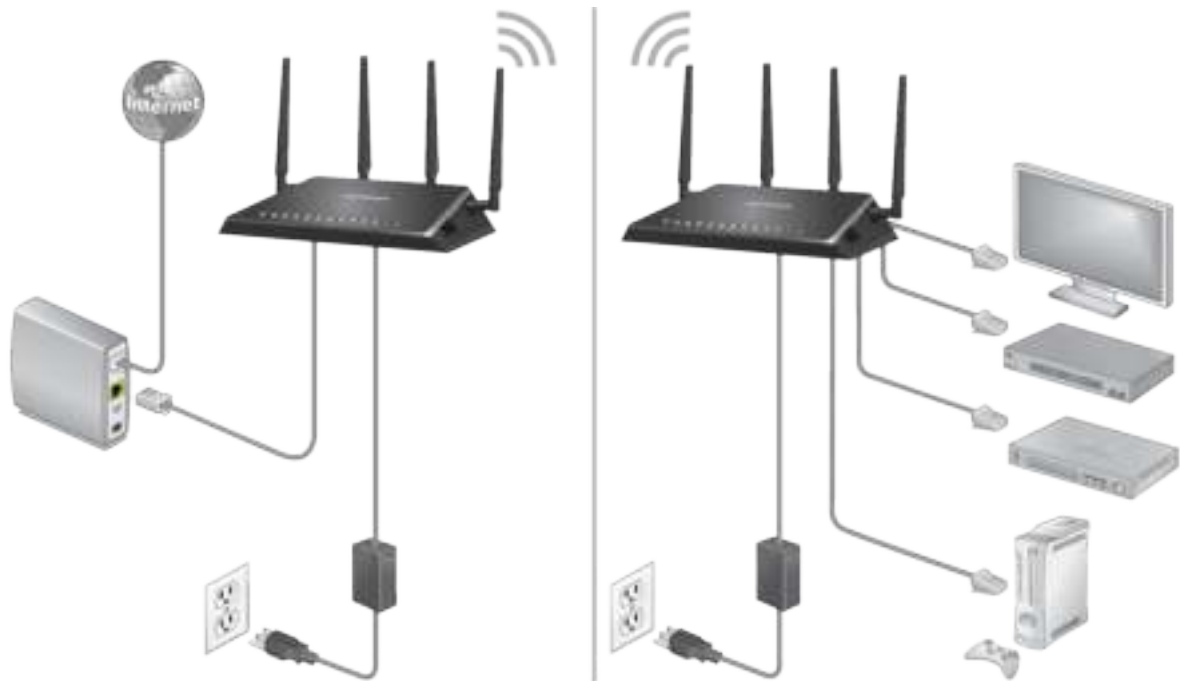

Figure 8. Router in bridge mode with an 802.11ac WiFi connection

Installing your router as a bridge offers the following benefits:

- You can take advantage of gigabit WiFi speeds on current devices.
- Use gigabit WiFi for applications like video and gaming.
- Connect multiple devices like a NAS, smart TV, NeoTV, Blu-ray player, and game consoles at gigabit WiFi speeds using a WiFi link.
- Avoid the need for separate WiFi adapters for each device.

For example, you could install the first router in a room such as a home office where your Internet connection is located.

Then set up the second router in bridge mode. Place the router in bridge mode in a different room such as the room where your home entertainment center is located. Cable the router in bridge mode to your smart TV, DVR, game console, or Blu-ray player, and use its 802.11ac WiFi connection to the first router.

► To set up bridge mode:

1. Make a note of the WiFi settings of the other router to which this router will connect.

You must know the SSID, WiFi security mode, WiFi password, and operating frequency (either 2.4 GHz or 5 GHz).

2. Launch a web browser from a computer or WiFi device that is connected to the network of the router that will run in bridge mode.

Nighthawk X4S AC2600 Smart WiFi Router

3. Type **http://www.routerlogin.net**.

A login window opens.

4. Enter the router user name and password.

The user name is **admin**. The default password is **password**. The user name and password are case-sensitive.

The BASIC Home page displays.

5. Select **ADVANCED > Advanced Setup > Wireless Bridge**.

The Wireless Bridge page displays.

6. Select the **Enable Bridge Mode** check box.

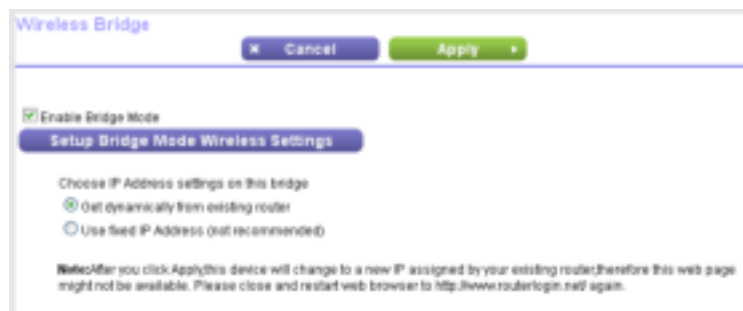

7. Click the **Setup Bridge Mode Wireless Settings** button.

8. Enter the settings of the other router:

- a. Select the WiFi network frequency (**2.4 GHz** or **5 GHz**).
- b. For 802.11ac mode, select **5 GHz**.
- c. In the **Name (SSID)** field, enter the WiFi network name (SSID).
- d. In the Security Option section, select a radio button.
- e. If prompted, type the passphrase (the WiFi password that you use to connect with WiFi to the other router).

9. Click the **Apply** button.

The settings for the other router are saved and the Advanced Wireless Settings page displays.

10. Click the **Apply** button on the Advanced Wireless Settings page.

Your settings are saved.

Set Up a Bridge for a Port Group or VLAN Tag Group

Some devices, such as an IPTV, cannot function behind the router's network address translation (NAT) service or firewall. Based on what your Internet service provider (ISP) requires, for the device to connect to the ISP's network directly, you can enable the bridge between the device and the router's Internet port or add new VLAN tag groups to the bridge.

Note If your ISP provides directions on how to set up a bridge for IPTV and Internet service, follow those directions.

Set Up a Bridge for a Port Group

If the devices that are connected to the router's Ethernet LAN port or WiFi network include an IPTV device, your ISP might require you to set up a bridge for a port group for the router's Internet interface.

A bridge with a port group prevents packets that are sent between the IPTV device and the router's Internet port from being processed through the router's network address translation (NAT) service.

► To configure a port group and enable the bridge:

1. Launch a web browser from a computer or WiFi device that is connected to the network.

2. Enter **http://www.routerlogin.net**.

A login window opens.

3. Enter the router user name and password.

The user name is **admin**. The default password is **password**. The user name and password are case-sensitive.

The BASIC Home page displays.

4. Select **ADVANCED > Advanced Setup > VLAN/Bridge Settings**.

The VLAN / Bridge Settings page displays.

5. Select the **Enable VLAN/Bridge Group** check box.

The page expands.

6. Select the **By bridge group** radio button.



7. Select a Wired Ports check box or a Wireless check box:

- If your device is connected to an Ethernet port on the router, select the Wired Ports check box that corresponds to the Ethernet port on the router to which the device is connected.
- If your device is connected to your router's WiFi network, select the Wireless check box that corresponds to the router's WiFi network to which the device is connected.

Note You must select at least one Wired Ports or Wireless check box. You can select more than one check box.

8. Click the **Apply** button.

Your settings are saved.

Set Up a Bridge for a VLAN Tag Group

If the devices that are connected to the router's Ethernet LAN ports or WiFi network include an IPTV device, your ISP might require you to set up a bridge for a VLAN tag group for the router's Internet interface.

If you are subscribed to IPTV service, the router might require VLAN tags to distinguish between the Internet traffic and the IPTV traffic. A bridge with a VLAN tag group prevents packets that are sent between the IPTV device and the router's Internet port from being processed through the router's network address translation (NAT) service.

You can add VLAN tag groups to a bridge and assign VLAN IDs and priority values to each VLAN tag group.

► To add a VLAN tag group and enable the bridge:

1. Launch a web browser from a computer or WiFi device that is connected to the network.
2. Enter **http://www.routerlogin.net**.

A login window opens.

3. Enter the router user name and password.

The user name is **admin**. The default password is **password**. The user name and password are case-sensitive.

The BASIC Home page displays.

4. Select **ADVANCED > Advanced Setup > VLAN/Bridge Settings**.

The VLAN / Bridge Settings page displays.

Nighthawk X4S AC2600 Smart WiFi Router

- Select the **Enable VLAN/Bridge Group** check box.



- Select the **By VLAN tag group** radio button.



- Specify the settings as described in the following table.

Field	Description
Name	Enter a name for the VLAN tag group. The name can be up to 10 characters.
VLAN ID	Enter a value from 1 to 4094.
Priority	Enter a value from 0 to 7.
<p>Select the check box for a wired LAN port or WiFi port.</p> <p>If your device is connected to an Ethernet port on the router, select the LAN port check box that corresponds to the Ethernet port on the router to which the device is connected. If your device is connected to your router's WiFi network, select the WiFi check box that corresponds to the router's WiFi network to which the device is connected.</p> <p>You must select at least one LAN port or WiFi port. You can select more than one port.</p>	

- Click the **Add** button.
The VLAN tag group is added.
- Click the **Apply** button.
Your settings are saved.

Set Up an IPTV Port to Lease an Intranet Port

You can set up the router to create an Internet Protocol television (IPTV) port that can lease an IP address from your IPTV service provider. Use this feature only if you subscribe to an IPTV service and your IPTV service requires an intranet address.

Some IPTV ports cannot work behind NAT because the IPTV port requires an IP address within the Internet service provider's network (intranet address). You can set up a bridge connection from the WAN to one of the LAN ports. When IPTV is connected through WiFi, the home router also must support the bridging of the WAN port to the WiFi network name (SSID). The designated LAN port or WiFi name becomes an IPTV port with direct access to the WAN without going through NAT.

► To configure an IPTV port:

1. Launch a web browser from a computer or WiFi device that is connected to the network.
2. Enter **http://www.routerlogin.net**.

A login window opens.

3. Enter the router user name and password.

The user name is **admin**. The default password is **password**. The user name and password are case-sensitive.

The BASIC Home page displays.

4. Select **ADVANCED > Advanced Setup > VLAN/Bridge Settings**.

The VLAN / Bridge Settings page displays.

5. Select the **Enable VLAN/Bridge Group** check box.

The page expands.

6. Select the **By bridge group** radio button.



7. Select a Wired Ports check box or a Wireless check box:

- If your device is connected to an Ethernet port on the router, select the Wired Ports check box that corresponds to the Ethernet port on the router to which the device is connected.
- If your device is connected to your router's WiFi network, select the Wireless check box that corresponds to the router's WiFi network to which the device is connected.

Note You must select at least one Wired Ports or Wireless check box. You can select more than one check box.

8. Click the **Apply** button.

Your settings are saved.

Optimize Performance

6

You can set up the router to optimize performance for applications such as Internet gaming, high-definition video streaming, and VoIP communication. By default, the router uses Wi-Fi Multimedia Quality of Service (WMM QoS).

This chapter contains the following sections:

- *Use Dynamic QoS to Optimize Internet Traffic Management* on page 89
- *Improve Network Connections With Universal Plug and Play* on page 92
- *Wi-Fi Multimedia Quality of Service* on page 93

Use Dynamic QoS to Optimize Internet Traffic Management

Dynamic Quality of Service (QoS) helps improve your router's Internet traffic management capabilities through better application and device identification, bandwidth allocation, and traffic prioritization techniques. Dynamic QoS resolves traffic congestion when the Internet bandwidth is limited and different demands compete for bandwidth.



Figure 9. Dynamic QoS optimizes Internet traffic by prioritizing competing demands

Enable Dynamic QoS

Because not everyone uses Dynamic QoS, it is disabled by default.

► To enable Dynamic QoS:

1. Launch a web browser from a computer or WiFi device that is connected to the network.
2. Enter **http://www.routerlogin.net**.
A login window opens.
3. Enter the router user name and password.
The user name is **admin**. The default password is **password**. The user name and password are case-sensitive.
The BASIC Home page displays.
4. Select **Quality of Service**.
The QoS Setup page displays.

5. Select the **Dynamic QoS** check box.
6. Specify your Internet bandwidth.

You must specify your Internet bandwidth so that Dynamic QoS can perform bandwidth allocation and traffic prioritization. We recommend that you use Speedtest to detect your Internet bandwidth.

To use Speedtest, do the following:

- a. For more accurate Speedtest results, make sure that no other devices are accessing the Internet.
- b. Click the **Speedtest** button.

Speedtest determines your Internet bandwidth.

7. Click the **Apply** button.

Your settings are saved.

A link displays on the bottom of the page that you click to view bandwidth utilization. Clicking the link displays the Attached Devices page. For more information, see *View Devices Currently on the Network* on page 103.

Enable or Disable the Automatic QoS Database Update

The router uses a QoS database of the most popular applications and services to implement Dynamic QoS. By default, the router automatically updates this database. You can turn off this feature and manually update the database.

► To enable or disable the automatic Dynamic QoS database update:

1. Launch a web browser from a computer or WiFi device that is connected to the network.
2. Enter **http://www.routerlogin.net**.

A login window opens.

3. Enter the router user name and password.

The user name is **admin**. The default password is **password**. The user name and password are case-sensitive.

The BASIC Home page displays.

4. Select **Dynamic QoS**.

The Dynamic QoS screen displays. If you are using Dynamic QoS, the **Enable Dynamic QoS** check box is selected.

5. Select or clear the **Automatically update performance optimization database** check box.
6. Click the **Apply** button.

Your settings are saved.

Manually Update the Dynamic QoS Database

The router uses a QoS database of the most popular applications and services to implement Dynamic QoS. By default, the router automatically updates this database when you enable Dynamic QoS, but if you turned off the automatic update feature, you can manually update the database.

► To manually update the Dynamic QoS database:

1. Launch a web browser from a computer or WiFi device that is connected to the network.
2. Enter **http://www.routerlogin.net**.

A login window opens.

3. Enter the router user name and password.

The user name is **admin**. The default password is **password**. The user name and password are case-sensitive.

The BASIC Home page displays.

4. Select **Dynamic QoS**.

The Dynamic QoS page displays. If you are using Dynamic QoS, the **Enable Dynamic QoS** check box is selected.

5. Click the **Update Now** button.

The router checks for the newest version of the database and downloads it.

6. Click the **Apply** button.

Your settings are saved.

Participate in Dynamic QoS Analytics

NETGEAR uses a QoS database of the most popular applications and services to implement Dynamic QoS. As new applications and services become popular, we update this database and automatically update your router if you enabled Dynamic QoS. You can opt in to share aggregate QoS information to help improve the Dynamic QoS feature.

► To opt in to participate in Dynamic QoS analytics:

1. Launch a web browser from a computer or WiFi device that is connected to the network.
2. Enter **http://www.routerlogin.net**.

A login window opens.

3. Enter the router user name and password.

The user name is **admin**. The default password is **password**. The user name and password are case-sensitive.

The BASIC Home page displays.

4. Select **Dynamic QoS**.
The Dynamic QoS page displays.
5. Make sure that you enabled Dynamic QoS.
For more information about enabling Dynamic QoS, see *Enable Dynamic QoS* on page 89.
6. Select the **Help improve the Dynamic QoS feature by sharing analytics with NETGEAR** check box.
A pop-up window displays detailed information about sharing analytics. The **Yes** radio button is selected by default.
7. Read the information and click the **Submit** button.
8. Click the **Apply** button.
Your settings are saved.

Improve Network Connections With Universal Plug and Play

Universal Plug and Play (UPnP) helps devices such as Internet appliances and computers access the network and connect to other devices as needed. UPnP devices can automatically discover the services from other registered UPnP devices on the network.

If you use applications such as multiplayer gaming, peer-to-peer connections, or real-time communications such as instant messaging or remote assistance (a feature in Windows XP), enable UPnP.

► To enable Universal Plug and Play:

1. Launch a web browser from a computer or WiFi device that is connected to the network.
2. Enter **http://www.routerlogin.net**.
A login window opens.
3. Enter the router user name and password.
The user name is **admin**. The default password is **password**. The user name and password are case-sensitive.
The BASIC Home page displays.
4. Select **ADVANCED > Advanced Setup > UPnP**.
The UPnP page displays.
5. Select the **Turn UPnP On** check box.
By default, this check box is selected. UPnP for automatic device configuration can be enabled or disabled. If the **Turn UPnP On** check box is cleared, the router does not allow any device to automatically control router resources, such as port forwarding.
6. Type the advertisement period in minutes.

The advertisement period specifies how often the router broadcasts its UPnP information. This value can range from 1 to 1440 minutes. The default period is 30 minutes. Shorter durations ensure that control points receive current device status at the expense of more network traffic. Longer durations can compromise the freshness of the device status but can significantly reduce network traffic.

7. Type the advertisement time to live in hops.

The time to live for the advertisement is measured in hops (steps) for each UPnP packet sent. Hops are the steps a packet takes between routers. The number of hops can range from 1 to 255. The default value for the advertisement time to live is 4 hops, which should be fine for most home networks. If you notice that some devices are not being updated or reached correctly, it might be necessary to increase this value.

8. Click the **Apply** button.

The UPnP Portmap Table displays the IP address of each UPnP device that is accessing the router and which ports (internal and external) that device opened. The UPnP Portmap Table also displays what type of port is open and whether that port is still active for each IP address.

To refresh the information in the UPnP Portmap Table, click the **Refresh** button.

Wi-Fi Multimedia Quality of Service

Wi-Fi Multimedia Quality of Service (WMM QoS) prioritizes WiFi voice and video traffic over the WiFi link. WMM QoS is automatically enabled for the router.

WMM QoS prioritizes WiFi data packets from different applications based on four access categories: voice, video, best effort, and background. For an application to receive the benefits of WMM QoS, WMM must be enabled for both it and the client running that application. Legacy applications that do not support WMM and applications that do not require QoS are assigned to the best effort category, which receives a lower priority than voice and video.

▶ To disable WMM QoS:

1. Launch an Internet browser from a computer or WiFi device that is connected to the network.
2. Enter **http://www.routerlogin.net**.

A login window opens.

3. Enter the router user name and password.

The user name is **admin**. The default password is **password**. The user name and password are case-sensitive.

The BASIC Home page displays.

4. Select **ADVANCED > Setup > QoS Setup**.

The Quality of Service page displays.

5. Click the **WMM** tab.
6. Clear the **Enable WMM (Wi-Fi multimedia) settings (2.4 GHz b/g/n)** check box.

Nighthawk X4S AC2600 Smart WiFi Router

7. Clear the **Enable WMM (Wi-Fi multimedia) settings (5 GHz a/n/ac)** check box.
8. Click the **Apply** button.

Your settings are saved.

Manage Your Network

7

This chapter describes the router settings for administering and maintaining your router and home network.

The chapter includes the following sections:

- *Update the Router Firmware* on page 96
- *Change the admin Password* on page 96
- *Set Up Password Recovery* on page 97
- *Recover the admin Password* on page 98
- *View Router Status* on page 99
- *View Devices Currently on the Network* on page 103
- *Monitor Internet Traffic* on page 104
- *Manage the Router Configuration File* on page 106
- *Remote Access* on page 108

Update the Router Firmware

The router firmware (routing software) is stored in flash memory. You might see a message at the top of the router pages when new firmware is available. You can respond to that message to update the firmware or you can check to see if new firmware is available and update your product.

► To check for new firmware and update your router:

1. Launch a web browser from a computer or WiFi device that is connected to the network.
2. Enter **http://www.routerlogin.net**.

A login window opens.

3. Enter the router user name and password.

The user name is **admin**. The default password is **password**. The user name and password are case-sensitive.

The BASIC Home page displays.

4. Select **ADVANCED > Administration > Firmware Update**.

The Router Update page displays.

5. Click the **Check** button.

The router finds new firmware information if any is available and displays a message asking if you want to download and install it.

6. Click the **Yes** button.

The router locates and downloads the firmware and begins the update.



WARNING:

To avoid the risk of corrupting the firmware, do not interrupt the update. For example, do not close the browser, click a link, or load a new page. Do not turn off the router.

When the upload is complete, your router restarts. The update process typically takes about one minute. Read the new firmware release notes to find out if you must reconfigure the router after updating.

Change the admin Password

You can change the default password that is used to log in to the router with the user name admin. This password is not the one that you use for WiFi access.

Note Be sure to change the password for the user name admin to a secure password. The ideal password contains no dictionary words from any language and contains uppercase and lowercase letters, numbers, and symbols. It can be up to 30 characters.

► To set the password for the user name admin:

1. Launch a web browser from a computer or WiFi device that is connected to the network.
2. Enter **http://www.routerlogin.net**.

A login window opens.

3. Enter the router user name and password.

The user name is **admin**. The default password is **password**. The user name and password are case-sensitive. The BASIC Home page displays.

4. Select **ADVANCED > Administration > Set Password**.

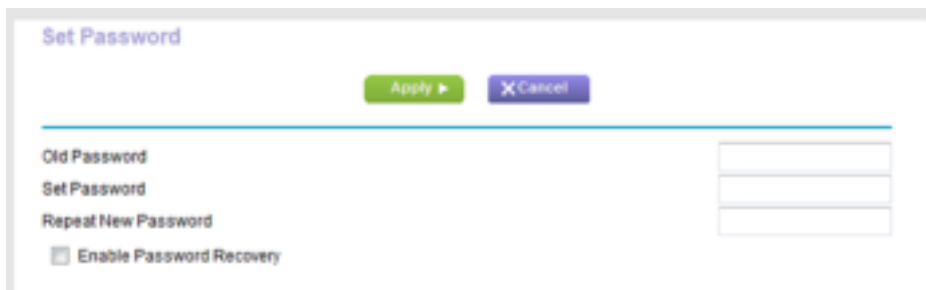

5. Type the old password, and type the new password twice.
6. To be able to recover the password, select the **Enable Password Recovery** check box.

We recommend that you enable password recovery.

7. Click the **Apply** button.

Your settings are saved.

Set Up Password Recovery

We recommend that you enable password recovery if you change the password for the router user name admin. Then you can recover the password if it is forgotten. This recovery process is supported in Internet Explorer, Firefox, and Chrome browsers but not in the Safari browser.

► To set up password recovery:

1. Launch a web browser from a computer or WiFi device that is connected to the network.
2. Enter **http://www.routerlogin.net**.
A login window opens.
3. Enter the router user name and password.
The user name is **admin**. The default password is **password**. The user name and password are case-sensitive.
The BASIC Home page displays.
4. Select **ADVANCED > Administration > Set Password**.
The Set Password page displays.
5. Select the **Enable Password Recovery** check box.
6. Select two security questions and provide answers to them.
7. Click the **Apply** button.
Your settings are saved.

Recover the admin Password

► To recover your password:

1. Launch a web browser from a computer or WiFi device that is connected to the network.
2. In the address field of your browser, enter **http://www.routerlogin.net**.
A login window opens.
3. Click the **Cancel** button.
If password recovery is enabled, you are prompted to enter the serial number of the router.
The serial number is on the label on the router.
4. Enter the serial number of the router.
5. Click the **Continue** button.
A window opens requesting the answers to your security questions.
6. Enter the saved answers to your security questions.
7. Click the **Continue** button.
A window opens and displays your recovered password.
8. Click the **Login again** button.

A login window opens.

9. With your recovered password, log in to the router.

View Router Status

► To view the router status and usage information:

1. Launch a web browser from a computer or WiFi device that is connected to the network.
2. Enter **http://www.routerlogin.net**.

A login window opens.

3. Enter the router user name and password.

The user name is **admin**. The default password is **password**. The user name and password are case-sensitive.

The BASIC Home page displays.

4. Click the **ADVANCED** tab.



Your router might display information that is different from this example. If your router is set up to lease an intranet address from your Internet service provider (ISP), the Internet Port pane displays the IP Address, Connection, and Subnet Mask intranet values in parentheses.

Display Internet Port Statistics

► **To display Internet port statistics:**

1. Launch a web browser from a computer or WiFi device that is connected to the network.
2. Enter **http://www.routerlogin.net**.

A login window opens.

3. Enter the router user name and password.

The user name is **admin**. The default password is **password**. The user name and password are case-sensitive.

The BASIC Home page displays.

4. Click the **ADVANCED** tab.

The ADVANCED Home page displays.

5. In the Internet Port pane, click the **Show Statistics** button.

Port	Status	TxPkts	RxPkts	Collisions	Tx B/s	Rx B/s	Up Time
WAN	1000MFull	2375	2827	0	566	985	00:09:43
LAN 1	Link Down	3671	3262	0	2176	745	00:00:00
LAN 2	1000MFull						00:03:03
LAN 3	Link Down						00:00:00
LAN 4	Link Down						00:00:00
WLAN bgn	600M	0	0	0	0	0	00:10:08
WLAN wlan	1733M	0	0	0	0	0	00:09:44

Poll Interval: (secs) Set Interval Stop

The following information displays:

- **System Up Time.** The time elapsed since the router was last restarted.
- **Port.** The statistics for the WAN (Internet) and LAN (Ethernet) ports. For each port, the screen displays the following information:
 - **Status.** The link status of the port.
 - **TxPkts.** The number of packets transmitted on this port since reset or manual clear.
 - **RxPkts.** The number of packets received on this port since reset or manual clear.
 - **Collisions.** The number of collisions on this port since reset or manual clear.
 - **Tx B/s.** The current transmission (outbound) bandwidth used on the WAN and LAN ports.
 - **Rx B/s.** The current reception (inbound) bandwidth used on the WAN and LAN ports.

Nighthawk X4S AC2600 Smart WiFi Router

- **Up Time.** The time elapsed since this port acquired the link.
 - **Poll Interval.** The interval at which the statistics are updated on this page.
6. To change the polling frequency, enter a time in seconds in the **Poll Interval** field and click the **Set Interval** button.

To stop the polling entirely, click the **Stop** button.

Check the Internet Connection Status

► To check the Internet connection status:

1. Launch a web browser from a computer or WiFi device that is connected to the network.
2. Enter **http://www.routerlogin.net**.

A login window opens.

3. Enter the router user name and password.

The user name is **admin**. The default password is **password**. The user name and password are case-sensitive.

The BASIC Home page displays.

4. Click the **ADVANCED** tab.

The ADVANCED Home page displays.

5. In the Internet Port pane, click the **Connection Status** button.



The screenshot shows a window titled "Connection Status" with a table of network information and control buttons below it.

Connection Status	
IP Address	10.1.10.29
Subnet Mask	255.255.255.0
Default Gateway	10.1.10.1
DHCP Server	10.1.10.1
DNS Server	75.75.75.75 75.75.76.76
Lease Obtained	7 Days, 0 Hours, 0 Minutes
Lease Expires	6 Days, 23 Hours, 48 Minutes

Below the table are two buttons: "Release" and "Renew". At the bottom center is a button with an "X" icon and the text "Close Window".

The following information displays:

Nighthawk X4S AC2600 Smart WiFi Router

- **IP Address.** The IP address that is assigned to the router.
 - **Subnet Mask.** The subnet mask that is assigned to the router.
 - **Default Gateway.** The IP address for the default gateway that the router communicates with.
 - **DHCP Server.** The IP address for the Dynamic Host Configuration Protocol server that provides the TCP/IP configuration for all the computers that are connected to the router.
 - **DNS Server.** The IP address of the Domain Name Service server that provides translation of network names to IP addresses.
 - **Lease Obtained.** The date and time when the lease was obtained.
 - **Lease Expires.** The date and time that the lease expires.
6. To return the status of all items to 0, click the **Release** button.
 7. To refresh the screen, click the **Renew** button.
 8. To exit the screen, click the **Close Window** button.

View and Manage Logs of Router Activity

The log is a detailed record of the websites you accessed or attempted to access and other router actions. Up to 256 entries are stored in the log.

▶ To view and manage logs:

1. Launch a web browser from a computer or WiFi device that is connected to the network.
2. Enter **http://www.routerlogin.net**.

A login window opens.

3. Enter the router user name and password.

The user name is **admin**. The default password is **password**. The user name and password are case-sensitive.

The BASIC Home page displays.

4. Select **ADVANCED > Administration > Logs**.



The Logs page shows the following information:

- **Action.** The action that occurred, such as whether Internet access was blocked or allowed.
 - **Source IP.** The IP address of the initiating device for this log entry.
 - **Target address.** The name or IP address of the website or news group visited or to which access was attempted.
 - **Date and time.** The date and time the log entry was recorded.
5. To customize the logs, scroll down and clear or select the check boxes in the Include in Log section.
 6. To refresh the log screen, click the **Refresh** button.
 7. To clear the log entries, click the **Clear Log** button.
 8. To email the log immediately, click the **Send Log** button.

View Devices Currently on the Network

You can view all computers or devices that are currently connected to your network.

► To view devices on the network:

1. Launch a web browser from a computer or WiFi device that is connected to the network.
2. Enter **http://www.routerlogin.net**.

A login window opens.

3. Enter the router user name and password.

The user name is **admin**. The default password is **password**. The user name and password are case-sensitive.

The BASIC Home page displays.

4. Select **Attached Devices**.

The Attached Devices page displays devices that are connected to the router through Ethernet (using a wired connection) or connected to a WiFi band in the WiFi network.

The IP address for devices can change because the router assigns an IP address to each device when it joins the network. The unique MAC address for each device does not change.

5. To update this page, click the **Refresh** button.

Monitor Internet Traffic

Traffic metering allows you to monitor the volume of Internet traffic that passes through the router Internet port. You can set limits for traffic volume.

► To monitor Internet traffic:

1. Launch a web browser from a computer or WiFi device that is connected to the network.
2. Enter **http://www.routerlogin.net**.

A login window opens.

3. Enter the router user name and password.

The user name is **admin**. The default password is **password**. The user name and password are case-sensitive.

The BASIC Home page displays.

4. Select **ADVANCED > Advanced Setup > Traffic Meter**.



5. Select the **Enable Traffic Meter** check box.
6. To control the volume of Internet traffic, use either the traffic volume control feature or the connection time control feature:
 - Select the **Traffic volume control by** radio button and then select one of the following options:
 - **No Limit**. No restriction is applied when the traffic limit is reached.
 - **Download only**. The restriction is applied to incoming traffic only.
 - **Both Directions**. The restriction is applied to both incoming and outgoing traffic.
 - Select the **Connection time control** radio button and enter the allowed hours in the **Monthly limit** field.
7. If your ISP charges for extra data volume when you make a new connection, enter the extra data volume in MB in the **Round up data volume for each connection by** field.
8. In the Traffic Counter section, set the traffic counter to begin at a specific time and date.
To start the traffic counter immediately, click the **Restart Counter Now** button.
9. In the Traffic Control section, specify whether the router should issue a warning message before the monthly limit of Mbytes or hours is reached.

By default, the value is 0 and no warning message is issued. You can select one of the following to occur when the limit is attained:

- The Internet LED blinks white or amber.
- The Internet connection is disconnected and disabled.

10. Click the **Apply** button.

The Internet Traffic Statistics section helps you to monitor the data traffic.

11. To update the Traffic Statistics section, click the **Refresh** button.
12. To display more information about the data traffic on your router and to change the poll interval, click the **Traffic Status** button.

Manage the Router Configuration File

The configuration settings of the router are stored within the router in a configuration file. You can back up (save) this file to your computer, restore it, or reset it to the factory default settings.

Back Up Settings

► To back up the router's configuration settings:

1. Launch a web browser from a computer or WiFi device that is connected to the network.
2. Enter **http://www.routerlogin.net**.

A login window opens.

3. Enter the router user name and password.

The user name is **admin**. The default password is **password**. The user name and password are case-sensitive.

The BASIC Home page displays.

4. Select **ADVANCED > Administration > Backup Settings**.

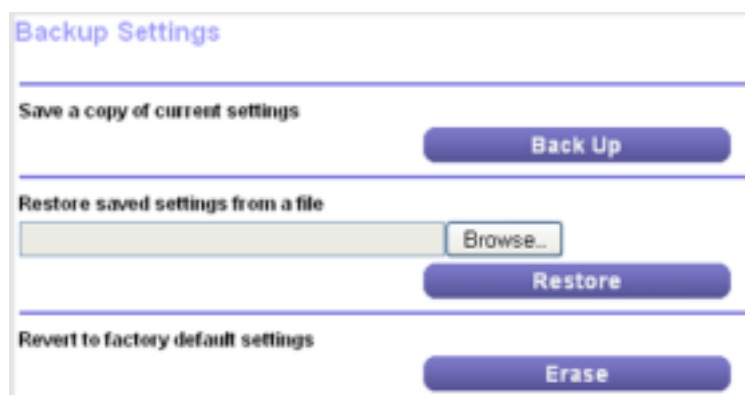

The screenshot shows the 'Backup Settings' page. It has three main sections, each separated by a horizontal line. The first section is titled 'Save a copy of current settings' and contains a blue 'Back Up' button. The second section is titled 'Restore saved settings from a file' and contains a text input field with a 'Browse...' button next to it, and a blue 'Restore' button below. The third section is titled 'Revert to factory default settings' and contains a blue 'Erase' button.

5. Click the **Back Up** button.
6. Follow the direction of your browser to save the file.

A copy of the current settings is saved in the location that you specified.

Erase the Current Configuration Settings

You can erase the current configuration and restore the factory default settings. You might want to do this if you move the router to a different network. (See *Factory Settings* on page 183.)

► To erase the configuration settings:

1. Launch a web browser from a computer or WiFi device that is connected to the network.
2. Enter **http://www.routerlogin.net**.
A login window opens.
3. Enter the router user name and password.
The user name is **admin**. The default password is **password**. The user name and password are case-sensitive.
The BASIC Home page displays.
4. Select **ADVANCED > Administration > Backup Settings**.
The Backup Settings page displays.
5. Click the **Erase** button.
The factory default settings are restored. The user name is admin, the password is password, and the LAN IP address is 192.168.1.1. DHCP is enabled.

Restore Configuration Settings

► To restore configuration settings that you backed up:

1. Launch a web browser from a computer or WiFi device that is connected to the network.
2. Enter **http://www.routerlogin.net**.
A login window opens.
3. Enter the router user name and password.
The user name is **admin**. The default password is **password**. The user name and password are case-sensitive.
The BASIC Home page displays.
4. Select **ADVANCED > Administration > Backup Settings**.
The Backup Settings page displays.
5. Click the **Browse** button to find and select the `.cfg` file.
6. Click the **Restore** button.
The file is uploaded to the router and the router reboots.



WARNING:
Do not interrupt the reboot process.

Remote Access

You can access your router over the Internet to view or change its settings. You must know the router's WAN IP address to use this feature. For information about remote access using Dynamic DNS, see [Set Up and Manage Dynamic DNS](#) on page 123.

Note Be sure to change the password for the user name admin to a secure password. The ideal password contains no dictionary words from any language and contains uppercase and lowercase letters, numbers, and symbols. It can be up to 30 characters. See [Change the admin Password](#) on page 96.

Set Up Remote Management

► To set up remote management:

1. Launch a web browser from a computer or WiFi device that is connected to the network.
2. Enter **http://www.routerlogin.net**.

A login window opens.

3. Enter the router user name and password.

The user name is **admin**. The default password is **password**. The user name and password are case-sensitive.

The BASIC Home page displays.

4. Select **ADVANCED > Advanced Setup > Remote Management**.

Remote Management

Cancel Apply

Turn Remote Management On

Remote Management Address: http://0.0.0.0:8443

Allow Remote Access By:

Only This Computer

IP Address Range

Everyone

From: [] [] [] []

To: [] [] [] []

Port Number: 8443

5. Select the **Turn Remote Management On** check box.

6. In the Allow Remote Access By section, specify the external IP addresses to be allowed to access the router's remote management.

Note For enhanced security, restrict access to as few external IP addresses as practical.

Select one of the following:

- **Only This Computer.** Allow access from a single IP address on the Internet. Enter the IP address to be allowed access.
 - **IP Address Range.** Allow access from a range of IP addresses on the Internet. Enter a beginning IP address and an ending IP address to define the allowed range.
 - **Everyone.** Allow access from any IP address on the Internet.
7. Specify the port number for accessing the web management interface.

Normal web browser access uses the standard HTTP service port 80. For greater security, enter a custom port number for the remote web management interface. Choose a number from 1024 to 65535, but do not use the number of any common service port. The default is 8080, which is a common alternate for HTTP.

8. Click the **Apply** button.

Your settings are saved.

Use Remote Access

► To use remote access:

1. Launch a web browser on a computer that is not on your home network.
2. Type your router's WAN IP address into your browser's address or location field followed by a colon (:) and the custom port number.

For example, if your external address is 134.177.0.123 and you use port number 8080, enter **http://134.177.0.123:8080** in your browser.

Remotely Access Your Router Using the genie App

You can use the genie app to remotely access your router and change its settings. Before you can use remote access with the genie app, you must update your router's firmware and download the latest genie app for your computer or mobile device. Remote access with the genie app is supported for Windows computers, iOS mobile devices, and Android mobile devices.

For more information about how to update your router's firmware, see *Update the Router Firmware* on page 96.

To download the latest genie app for your computer or mobile device, visit NETGEAR.com/genie. For more information about how to set up remote access using the genie app, see the genie app user manual, which is available at downloadcenter.netgear.com/.

Share USB Storage Devices Attached to the Router

8

This chapter describes how to access and manage storage devices attached to your router. ReadySHARE lets you access and share USB storage devices connected to the router. (If your storage device uses special drivers, it is not compatible.)

Note The USB ports on the router can be used only to connect USB storage devices like flash drives or hard drives or a printer. Do not connect computers, USB modems, CD drives, or DVD drives to the router USB port.

This chapter contains the following sections:

- *USB Device Requirements* on page 111
- *Connect a Storage Device to the Router* on page 111
- *Access a Storage Device Connected to the Router From a Windows Computer* on page 112
- *Map a USB Device to a Windows Network Drive* on page 112
- *Access a Storage Device That Is Connected to the Router From a Mac* on page 113
- *Back Up Windows Computers With ReadySHARE Vault* on page 114
- *Back Up Mac Computers With Time Machine* on page 114
- *Use FTP Within the Network* on page 117
- *View or Change Network Folders on a Storage Device* on page 117
- *Safely Remove a USB Device* on page 121

For more information about ReadySHARE features, visit netgear.com/readystatechange.

USB Device Requirements

The router works with most USB-compliant external flash and hard drives. For the most up-to-date list of USB devices that the router supports, visit kb.netgear.com/app/answers/detail/a_id/18985/~/readyshare-usb-drives-compatibility-list.

Some USB external hard drives and flash drives require you to load the drivers onto the computer before the computer can access the USB device. Such USB devices do not work with the router.

The router supports the following file system types for full read/write access:

- FAT16
- FAT32
- NTFS
- NTFS with compression format enabled
- Ext2
- Ext3
- Ext4
- HFS
- HFS+

Connect a Storage Device to the Router

ReadySHARE lets you access and share USB and eSATA devices that are connected to the appropriate router port. (If your USB device uses special drivers, it is not compatible.)

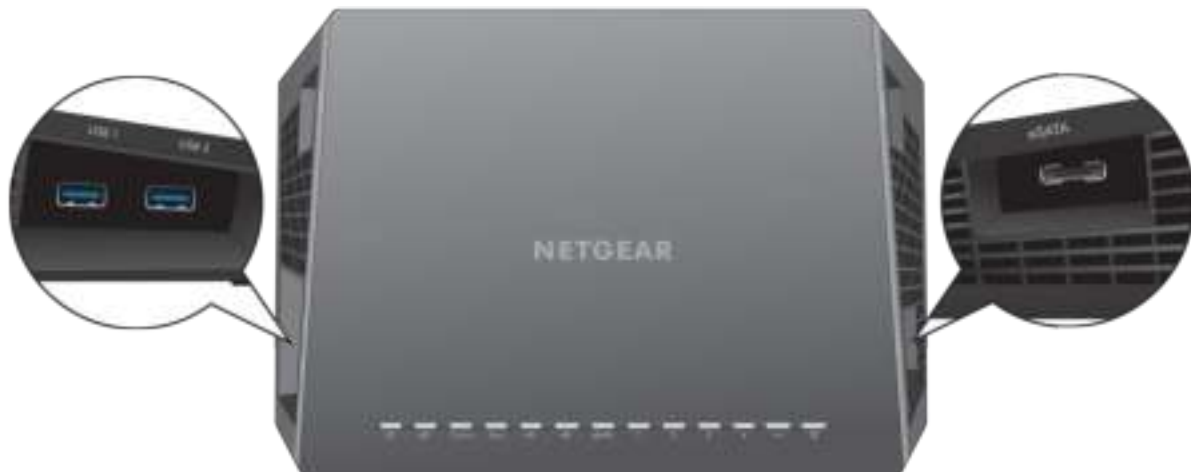

Figure 10. USB 3.0 and an eSATA port are located on the sides of the router

► To connect a USB device:

1. Insert your USB storage drive into a USB port on the side panel of the router.
2. If your USB device uses a power supply, connect it.

You must use the power supply when you connect the USB device to the router.

When you connect the USB device to the router USB port, it might take up to two minutes before it is ready for sharing. By default, the USB device is available to all computers on your local area network (LAN).

Access a Storage Device Connected to the Router From a Windows Computer

► To access the device from a Windows computer:

1. Connect a USB or eSATA storage device to the appropriate port on the router.

If your storage device uses a power supply, you must use it when you connect the device to the router.

When you connect the storage device to the router's port, it might take up to two minutes before it is ready for sharing. By default, the device is available to all computers on your local area network (LAN).

2. Select **Start > Run**.
3. Enter `\\readyshare` in the dialog box.
4. Click the **OK** button.

A window automatically opens and displays the files and folders on the device.

Map a USB Device to a Windows Network Drive

► To map the USB device to a Windows network drive:

1. Connect a USB storage device to a USB port on the router.

If your storage device uses a power supply, you must use it when you connect the device to the router.

When you connect the storage device to the router's port, it might take up to two minutes before it is ready for sharing. By default, the device is available to all computers on your local area network (LAN).

2. Select **Start > Run**.
3. Enter `\\readyshare` in the dialog box.

4. Click the **OK** button.
5. Right-click the USB device and select **Map network drive**.
6. Select the drive letter to map to the new network folder.
7. Click the **Finish** button.

The USB device is mapped to the drive letter that you specified.

8. To connect to the USB storage device as a different user, select the **Connect using different credentials** check box, click the **Finish** button, and do the following:
 - a. Type the user name and password.
 - b. Click the **OK** button.

The USB device is mapped to the drive letter that you specified.

Access a Storage Device That Is Connected to the Router From a Mac

From a computer or device on the network, you can access a storage device that is connected to the router.

▶ To access the device from a Mac:

1. Connect a USB or eSATA storage device to the appropriate port on the router.

If your storage device uses a power supply, you must use it when you connect the device to the router.

When you connect the storage device to the router's port, it might take up to two minutes before it is ready for sharing. By default, the device is available to all computers on your local area network (LAN).

2. On a Mac that is connected to the network, select **Go > Connect to Server**.
3. In the **Server Address** field, enter **smb://readyshare**.
4. When prompted, select the **Guest** radio button.

If you set up access control on the router and you allowed your Mac to access the network, select the **Registered User** radio button and enter **admin** for the name and **password** for the password. For more information about access control, see the user manual, which is available online at downloadcenter.netgear.com or through a link in the router's user interface.

5. Click the **Connect** button.

A window automatically opens and displays the files and folders on the device.

Back Up Windows Computers With ReadySHARE Vault

Your router comes with free backup software for all the Windows computers in your home. Connect a USB hard disk drive (HDD) or an eSATA storage device to the router for centralized, continuous, and automatic backup.

The following operating systems support ReadySHARE Vault:

- Windows XP SP3
- Windows 7
- Windows 8
- Windows 8.1

► To back up your Windows computer:

1. Connect a USB HDD or eSATA storage device to the appropriate port on the router.
2. If your USB device uses a power supply, connect it.

You must use the power supply when you connect the USB device to the router.

When you connect the USB device to the router USB port, it might take up to two minutes before it is ready for sharing. By default, the USB device is available to all computers on your local area network (LAN).

3. Download ReadySHARE Vault from netgear.com/readysware and install it on each Windows computer.
4. Launch ReadySHARE Vault.
5. Use the dashboard or the **Backup** tab to set up and run your backup.

Back Up Mac Computers With Time Machine

You can use Time Machine to back up your Mac computers onto a USB hard drive that is connected to one of the router's USB ports or an eSATA storage device that is connected to the router eSATA port. You can access the connected storage device from your Mac with a wired or WiFi connection to your router.

Set Up a USB Hard Drive on a Mac

NETGEAR recommends that you use a new USB HDD or format your old USB HDD to do the Time Machine backup for the first time. Use a blank partition to prevent some issues during backup using Time Machine. The router supports GUID or MBR partitions.

► To format your USB hard disk drive and specify partitions:

1. Physically connect the USB hard drive to your Mac.
2. On your Mac, go to **Spotlight** (or the magnifying glass) at the top right of the page and search for **Disk Utility**.
3. Open the Disk Utility, select your USB HDD, click the **Erase** tab, and click the **Erase** button.
4. Click the **Partition** tab.
5. In the **Partition Layout** menu, set the number of partitions that you want to use.

6. Click the **Options** button.

The Partition schemes display.

7. Select the **GUID Partition Table** or **Master Boot Record** radio button.
8. In the **Format** menu, select **Mac OS Extended (Journaled)**.
9. Click the **OK** button.
10. Click the **Apply** button.

Your settings are saved.

Prepare to Back Up a Large Amount of Data

Before you back up a large amount of data with Time Machine, NETGEAR recommends that you follow this procedure.

► To prepare to back up a large amount of data:

1. Upgrade the operating system of the Mac computer.
2. Verify and repair the backup disk and the local disk.
3. Verify and repair the permissions on the local disk.
4. Set Energy Saver:
 - a. From the **Apple** menu, select **System Preferences**.
The System Preferences window displays.
 - b. Select **Energy Saver**.
The Energy Saver page displays.
 - c. Click the **Power Adapter** tab.
 - d. Select the **Wake for Wi-Fi network access** check box.
 - e. Click the **back arrow** to save the changes and exit the screen.
5. Modify your security settings:
 - a. From the **System Preferences** window, select **Security & Privacy**.
The Security & Privacy page displays.
 - b. Click the **Advanced** button at the bottom of the page.
If the **Advanced** button is grayed out, click the lock icon so that you can change the settings.
 - c. Clear the **Log out after minutes of inactivity** check box.
 - d. Click the **OK** button.
Your settings are saved.

Use Time Machine to Back Up Onto a USB Hard Disk

You can use Time Machine to back up your Mac computers onto a USB hard disk drive (HDD) that is connected to one of the router's USB ports.

► To back up your Mac onto a USB hard disk drive:

1. Prepare your USB device with a compatible format and partitions.

For more information, see *Set Up a USB Hard Drive on a Mac* on page 114.

2. If you plan to back up a large amount of data, see *Prepare to Back Up a Large Amount of Data* on page 115.
3. Connect your USB HDD to a USB port on the router.

If your USB HDD uses a power supply, you must use it when you connect the USB HDD to the router.

When you connect the USB HDD to the router, it might take up to two minutes before it is ready for sharing. By default, the USB HDD is available to all computers on your local area network (LAN).

4. On a Mac computer that is connected to the network, launch Finder and select **Go > Connect to Server**.

The Connect to Server window displays.

5. Type **smb://routerlogin.net** and click the **Connect** button.
6. When prompted, select the **Registered User** radio button.
7. Enter **admin** for the name and **password** for the password and click the **Connect** button.

A list of USB devices connected to your router displays.

8. From the **Apple** menu, select **System Preferences**.

The System Preferences window displays.

9. Select **Time Machine**.

The Time Machine window displays.

10. Click the **Select Backup Disk** button and select your USB HDD from the list.

11. Click the **Use Disk** button.

Note If you do not see the USB partition that you want in the Time Machine disk list, go to Mac Finder and click that USB partition. It displays in the Time Machine list.

12. When prompted, select the **Registered User** radio button.

13. Enter **admin** for the name and **password** for the password and click the **Connect** button.

When the setup is complete, the Mac automatically schedules a full backup. You can back up immediately if you want.

Use FTP Within the Network

File Transfer Protocol (FTP) lets you send and receive large files faster.

► To set up FTP access:

1. Launch a web browser from a computer or WiFi device that is connected to the network.

2. Enter **http://www.routerlogin.net**.

A login window opens.

3. Enter the router user name and password.

The user name is **admin**. The default password is **password**. The user name and password are case-sensitive.

The BASIC Home page displays.

4. Select **ADVANCED > ReadySHARE > Advanced Settings**.

The USB Storage (Advanced Settings) page displays.

5. Select the **FTP** check box.

6. Click the **Apply** button.

Your settings are saved.

View or Change Network Folders on a Storage Device

You can view or change the network folders on a storage device connected to the router.

► To view or change network folders:

1. Launch a web browser from a computer or WiFi device that is connected to the network.

2. Enter **http://www.routerlogin.net**.

A login window opens.

3. Enter the router user name and password.

The user name is **admin**. The default password is **password**. The user name and password are case-sensitive.

The BASIC Home page displays.

Nighthawk X4S AC2600 Smart WiFi Router

4. Select **ADVANCED > ReadySHARE > ReadySHARE Storage > Advanced Settings**.



5. Scroll down to the Available Networks Folder section and adjust the following settings:
 - **Share Name.** If only one USB device is connected, the default share name is USB_Storage. You can click the name or you can type it in the address field of your web browser. If Not Shared is shown, the default share was deleted and no other share for the root folder exists. Click the link to change this setting.
 - **Read Access and Write Access.** Show the permissions and access controls on the network folder. All-no password (the default) allows all users to access the network folder. The password for admin is the same one that you use to log in to the router.
 - **Folder Name.** Full path of the network folder.
 - **Volume Name.** Volume name from the storage device.
 - **Total Space and Free Space.** Show the current utilization of the storage device.
6. Click the **Apply** button.

Your settings are saved.

Add a Network Folder on a Storage Device

You can add network folders on a USB or eSATA storage device connected to the router ports.

► To add a network folder:

1. Launch a web browser from a computer or WiFi device that is connected to the network.
2. Enter **http://www.routerlogin.net**.

A login window opens.

3. Enter the router user name and password.

The user name is **admin**. The default password is **password**. The user name and password are case-sensitive.

The BASIC Home page displays.

4. Select **ADVANCED > ReadySHARE > ReadySHARE Storage > Advanced Settings**.



5. Select the device.
6. Click the **Create Network Folder** button.

The Add Folder window opens.

If this window does not open, your web browser might be blocking pop-ups. If it is, change the browser settings to allow pop-ups.

7. Complete the fields.

Nighthawk X4S AC2600 Smart WiFi Router

The user name (account name) for All–no password is guest. The password for admin is the same one that is used to log in to the router. By default, it is password.

8. Click the **Apply** button.

The folder is added on the storage device.

Edit a Network Folder on a Storage Device

You can edit network folders on storage devices connected to the router USB ports or the eSATA port.

► To edit a network folder:

1. Launch a web browser from a computer or WiFi device that is connected to the network.
2. Enter **http://www.routerlogin.net**.

A login window opens.

3. Enter the router user name and password.

The user name is **admin**. The default password is **password**. The user name and password are case-sensitive.

The BASIC Home page displays.

4. Select **ADVANCED > ReadySHARE > ReadySHARE Storage > Advanced Settings**.



5. Click the **Edit** button.

The Edit Network Folder window opens.

6. Change the settings in the fields as needed.
7. Click the **Apply** button.

Your changes are saved.

Safely Remove a USB Device

Before you physically disconnect a USB device from the router USB port, log in to the router and take the drive offline.

▶ To remove a USB disk drive safely:

1. Launch a web browser from a computer or WiFi device that is connected to the network.
2. Enter <http://www.routerlogin.net>.

A login window opens.

3. Enter the router user name and password.

The user name is **admin**. The default password is **password**. The user name and password are case-sensitive.

The BASIC Home page displays.

4. Select **USB Storage > Basic Settings**.

The USB Settings page displays.

5. Click the **Safely Remove USB Device** button.

This takes the device offline.

6. Physically disconnect the USB device.

Use Dynamic DNS to Access USB Storage Devices Through the Internet

9

With Dynamic DNS, you can use the Internet to access USB devices attached to the router's USB ports when you're not home.

This chapter includes the following sections:

- [Set Up and Manage Dynamic DNS](#) on page 123
- [Set Up FTP Access Through the Internet](#) on page 123
- [Your Personal FTP Server](#) on page 124
- [Access USB Storage Devices Through the Internet](#) on page 129
- [Remotely Access a USB Device Using ReadyCLOUD](#) on page 129
- [Download Files Onto a USB Storage Device](#) on page 132
- [View Photos on Your USB Device With Kwillt](#) on page 135

For information about how to connect the device and specify its settings, see [Share USB Storage Devices Attached to the Router](#) on page 110.

Set Up and Manage Dynamic DNS

Internet service providers (ISPs) assign numbers called IP addresses to identify each Internet account. Most ISPs use dynamically assigned IP addresses. This means that the IP address can change at any time. You can use the IP address to access your network remotely, but most people don't know what their IP addresses are or when this number changes.

To make it easier to connect, you can get a free account with a Dynamic DNS service that lets you use a domain name to access your home network. To use this account, you must set up the router to use Dynamic DNS. Then the router notifies the Dynamic DNS service provider whenever its IP address changes. When you access your Dynamic DNS account, the service finds the current IP address of your home network and automatically connects you.

If your ISP assigns a private WAN IP address (such as 192.168.x.x or 10.x.x.x), the Dynamic DNS service does not work because private addresses are not routed on the Internet.

Set Up FTP Access Through the Internet

► To set up FTP access:

1. Launch a web browser from a computer or WiFi device that is connected to the network.
2. Enter **http://www.routerlogin.net**.

A login window opens.

3. Enter the router user name and password.

The user name is **admin**. The default password is **password**. The user name and password are case-sensitive.

The BASIC Home page displays.

4. Select **ADVANCED > ReadySHARE > Advanced Settings**.

The ReadySHARE Advanced Settings page displays.

5. Select the **FTP (via Internet)** check box.

6. Click the **Apply** button.

Your changes are saved.

7. To limit access to the admin user, click the **Edit** button.

The Edit page displays.

8. In the **Read Access** list, select **admin**.

9. In the **Write Access** list, select **admin**.

10. Click the **Apply** button.

Your settings are saved.

Your Personal FTP Server

With your customized free URL, you can use FTP to access your network when you aren't home through Dynamic DNS. To set up your FTP server, you must register for a NETGEAR Dynamic DNS (DDNS) service account and specify the account settings. See [Set Up a New Dynamic DNS Account](#) on page 125.

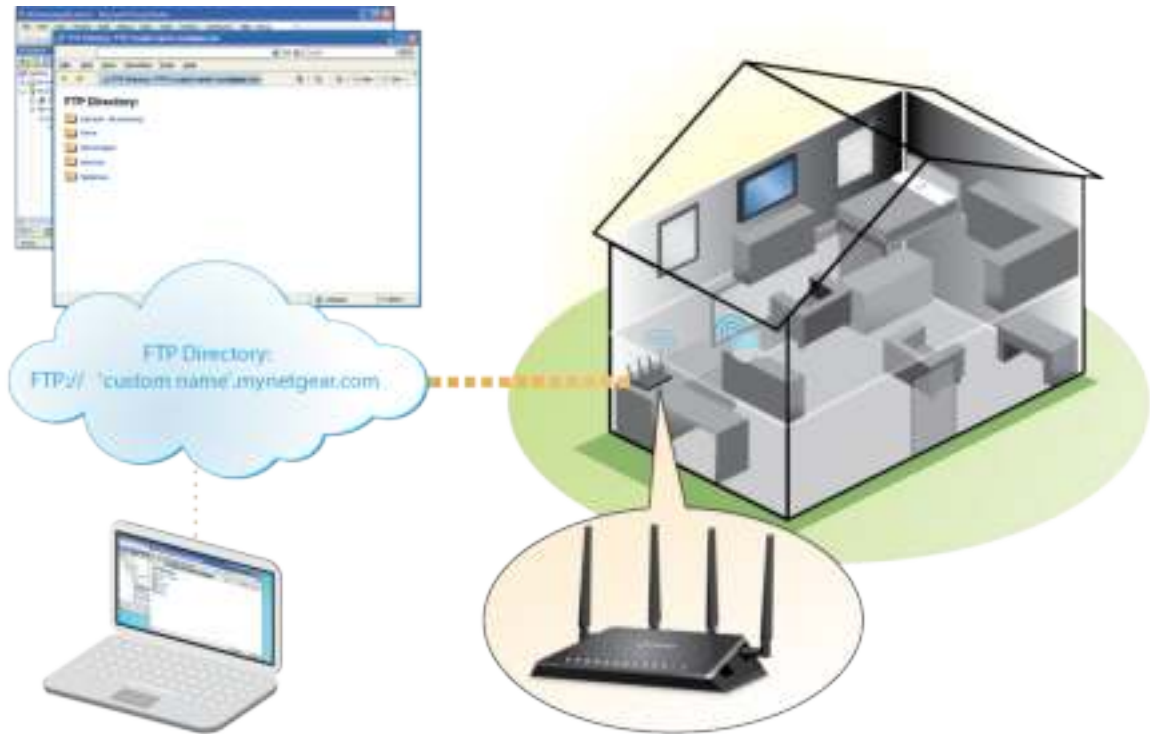

Figure 11. You can access your network through the Internet when you're not home

Note The router supports only basic DDNS, and the login and password might not be secure. You can use DDNS with a VPN tunnel for a secure connection.

Set Up Your Personal FTP Server

► **To set up your personal account and use FTP:**

1. Get your NETGEAR Dynamic DNS domain name.

For more information, see [Your Personal FTP Server](#) on page 124.

2. Make sure that your Internet connection is working.

Nighthawk X4S AC2600 Smart WiFi Router

Your router must use a direct Internet connection. It cannot connect to a different router to access the Internet.

3. Connect a storage device to the router.
4. If your USB device uses a power supply, connect it.

You must use the power supply when you connect the USB device to the router.

When you connect the USB device to the router USB port, it might take up to two minutes before it is ready for sharing. By default, the USB device is available to all computers on your local area network (LAN).

5. Set up FTP access in the router.

See *Set Up FTP Access Through the Internet* on page 123.

6. On a remote computer with Internet access, you can use FTP to access your router using `ftp://yourname.mynetgear.com`.

Set Up a New Dynamic DNS Account

► To set up Dynamic DNS and register for a free NETGEAR account:

1. Launch a web browser from a computer or WiFi device that is connected to the network.
2. Enter `http://www.routerlogin.net`.

A login window opens.

3. Enter the router user name and password.

The user name is **admin**. The default password is **password**. The user name and password are case-sensitive.

The BASIC Home page displays.

4. Select **ADVANCED > Advanced Setup > Dynamic DNS**.

5. Select the **Use a Dynamic DNS Service** check box.
6. From the **Service Provider** menu, select **NETGEAR**.
You can select another service provider.
7. Select the **No** radio button.
8. In the **Host Name** field, type the name that you want to use for your URL.
The host name is sometimes called the domain name. Your free URL includes the host name that you specify and ends with mynetgear.com. For example, specify *MyName.mynetgear.com*.
9. In the **Email** field, type the email address for your account.
10. In the **Password (6-32 characters)** field, type the password for your account.
11. Click the **Register** button.
12. Follow the onscreen instructions to register for your NETGEAR Dynamic DNS service.

Specify a DNS Account That You Already Created

If you already created a Dynamic DNS account with NETGEAR, No-IP, or Dyn, you can set up the router to use your account.

► To set up Dynamic DNS if you already created an account:

1. Launch a web browser from a computer or WiFi device that is connected to the network.
2. Enter **http://www.routerlogin.net**.

A login window opens.

Nighthawk X4S AC2600 Smart WiFi Router

3. Enter the router user name and password.

The user name is **admin**. The default password is **password**. The user name and password are case-sensitive. The BASIC Home page displays.

4. Select **ADVANCED > Advanced Setup > Dynamic DNS**.



The screenshot shows the 'Dynamic DNS' configuration page. At the top, there are three buttons: 'Show Status', 'Cancel', and 'Apply'. Below these is a checkbox labeled 'Use a Dynamic DNS Service'. Underneath, there is a 'Service Provider' dropdown menu set to 'NETGEAR'. A question asks 'Do you have a NETGEAR DDNS or a No-IP DDNS account?' with 'Yes' and 'No' radio buttons. Below this, there are three text input fields for 'Host Name' (containing 'my.netgear.com'), 'Email', and 'Password (6-32 characters)'. A 'Register' button is at the bottom left, and a line of text at the bottom states: 'By submitting this form I agree to the [Terms of Service](#) and that I will only create one free account.'

5. Select the **Use a Dynamic DNS Service** check box.
6. From the **Service Provider** menu, select your provider.
7. Select the **Yes** radio button.

The page adjusts and displays the **Show Status**, **Cancel**, and **Apply** buttons.

8. In the **Host Name** field, type the host name (sometimes called the domain name) for your account.
9. For a No-IP or Dyn account, in the **User Name** field, type the user name for your account.
10. For a NETGEAR account at No-IP, in the **Email** field, type the email address for your account.
11. In the **Password (6-32 characters)** field, type the password for your DDNS account.
12. Click the **Apply** button.

Your settings are saved.

13. To verify that your Dynamic DNS service is enabled in the router, click the **Show Status** button.

A message displays the Dynamic DNS status.

Change the Dynamic DNS Settings

You can change the settings for your Dynamic DNS account.

► To change your settings:

1. Launch a web browser from a computer or WiFi device that is connected to the network.
2. Enter **http://www.routerlogin.net**.

A login window opens.

3. Enter the router user name and password.

The user name is **admin**. The default password is **password**. The user name and password are case-sensitive.

The BASIC Home page displays.

4. Select **ADVANCED > Advanced Setup > Dynamic DNS**.

The Dynamic DNS page displays.

5. Change your DDNS account settings as necessary.
6. Click the **Apply** button.

Your settings are saved.

Access USB Storage Devices Through the Internet

You can access USB storage devices through the Internet when you're not home.

► To access devices from a remote computer:

1. Launch a web browser on a computer that is not on your home network.
2. Connect to your home router:
 - To connect with Dynamic DNS, type the DNS name.
To use a Dynamic DNS account, you must enter the account information on the Dynamic DNS page. See *Set Up and Manage Dynamic DNS* on page 123.
 - To connect without Dynamic DNS, type the router's Internet port IP address.

You can view the router's Internet IP address on the BASIC Home page.

You can use FTP to share files on a USB device connected to the router.

Remotely Access a USB Device Using ReadyCLOUD

NETGEAR ReadyCLOUD for routers lets you remotely access files stored on a USB storage device that is connected to the router. Before you can use ReadyCLOUD, you must create a ReadyCLOUD account and register your router.

A ReadyCLOUD app is also available for Windows computers, Android mobile devices, and iOS mobile devices. For more information about setting up ReadyCLOUD, see the *ReadyCLOUD for Routers User Manual*, which is available online at downloadcenter.netgear.com.

Create a ReadyCLOUD Account

► To create a ReadyCLOUD account:

1. Launch a web browser from a computer or WiFi device.
2. Visit readycloud.netgear.com.

The ReadyCLOUD Welcome page displays.

3. Click the **Sign In** link.

The Sign In page displays.

4. Click the **Create Account** link.

Setup ReadyCLOUD account to access your files from anywhere



User Name:

First Name:

Last Name:

E-mail:

Password:

Re-enter Password:

I agree to the [terms and conditions](#)

5. Complete the fields to set up your account, and click the **Create** button.

You are now ready to register your router with your ReadyCLOUD account.

Register Your Router With ReadyCLOUD

After you create a ReadyCLOUD account, you must register your router with your ReadyCLOUD account.

▶ To register your router with your ReadyCLOUD account:

1. Visit kb.netgear.com/app/answers/detail/a_id/27323/ and check to see if your router supports ReadyCLOUD.
2. Connect a USB storage device to a USB port on the router.

If your USB storage device uses a power supply, you must use it when you connect the USB storage device to the router.

When you connect the USB storage device to the router's USB port, it might take up to two minutes before it is ready for sharing. By default, the USB storage device is available to all computers on your local area network (LAN).

3. Launch a web browser from a computer or WiFi device that is connected to the network.
4. Enter **http://www.routerlogin.net**.

A login window opens.

5. Enter the router user name and password.

The user name is **admin**. The default password is **password**. The user name and password are case-sensitive.

The BASIC Home page displays.

6. Select **ADVANCED > USB Functions > ReadySHARE Storage**.
The ReadySHARE page displays.
7. Click the **ReadyCLOUD** tab.

8. Enter your ReadyCLOUD user name and password and click the **Register** button.
If you did not create a ReadyCLOUD account, see [Create a ReadyCLOUD Account](#) on page 129.
The router is registered with ReadyCLOUD.

Note If the router's Internet connection mode is set to **Dial on Demand**, the router automatically changes the connection mode to **Always On**. This change is required for ReadyCLOUD to remotely access the USB storage device.

9. After registration, visit readycloud.netgear.com.
10. Click the **Sign In** link, enter your ReadyCLOUD user name and password, and click the **Sign In** button.
The ReadyCLOUD page displays the router that you registered and the contents of the USB storage device that is connected to the router.

Download Files Onto a USB Storage Device

NETGEAR Downloader is a download agent that runs on the router. You can use it to download files onto a USB HDD that is connected to the router so that you do not need to keep the computer running.

Download Files

► To access devices from a remote computer:

1. Connect your USB storage device to the router USB port.
2. If your USB device uses a power supply, connect it.

You must use the power supply when you connect the USB device to the router.

When you connect the USB device to the router USB port, it might take up to two minutes before it is ready for sharing. By default, the USB device is available to all computers on your local area network (LAN).

3. Launch a web browser on a computer that is not on your home network.
4. Enter **http://www.routerlogin.net**.

A login window opens.

5. Enter the router user name and password.

The user name is **admin**. The default password is **password**. The user name and password are case-sensitive.

The BASIC Home page displays.

6. Select **NETGEAR Downloader (BETA)**.
The Download Manager page displays.

7. Select the **Enable NETGEAR Downloader** check box.

8. From the **Download Type** menu, select a download protocol.
The field changes based on which protocol you select.
9. Complete the fields presented for the option you selected.

10. Click the **Add** button.

The router begins the download.

11. To display the downloading status, click the **Refresh** button.

12. Click the **Apply** button.

Your settings are saved.

You can use the **Pause**, **Resume**, and **Delete** buttons to manage the downloading tasks. The completed downloading tasks display in the Downloaded Files section.

Change the Download Settings

You can change the default save path to any directory on the USB storage device that is connected to the router. You can change the maximum number of concurrent downloading tasks, but we recommend 3 as the most effective setting. You can enable autorefresh to see updated downloading tasks, but this might slow down speed of the downloads.

► To change NETGEAR Downloader settings:

1. Launch a web browser on a computer that is connected to the network.
2. Enter **http://www.routerlogin.net**.

A login window opens.

3. Enter the router user name and password.

The user name is **admin**. The default password is **password**. The user name and password are case-sensitive.

The BASIC Home page displays.

4. Select **NETGEAR Downloader (BETA)**.

NETGEAR Downloader Settings

Cancel Apply

Save Path
Which folder or path would you like to store?
/ Browse

Total Max Concurrent Downloading Tasks
6
The total concurrent downloading tasks allowed regardless of which kind of service (FTP/HTTP, BT, or eDonkey)

Maximum Download Speed per task (0 means no limit)
0 KB/s

Maximum Upload Speed per task (0 means no limit)
10 KB/s
Upper limit per task. Once set, each download or upload task can use a speed less than or equal to the value you set here.

Enable Auto Status Refresh
The downloading task status will be refreshed automatically according to specified rate
Refresh rate: 3 Times/Minute

Send e-mail notification when a downloader task is finished.
Configure Email

5. Make any needed changes.
6. Click the **Apply** button.

Your settings are saved.

Send Downloader Email Notifications

The router can email you when a downloader task is finished.

▶ To set up email notifications when a downloader task is finished:

1. Launch a web browser on a computer that is not on your home network.
2. Enter **http://www.routerlogin.net**.

A login window opens.

3. Enter the router user name and password.

The user name is **admin**. The default password is **password**. The user name and password are case-sensitive.

The BASIC Home page displays.

4. Select **NETGEAR Downloader (BETA)**.

NETGEAR Downloader Settings

Cancel Apply

Save Path
Which folder or path would you like to store?
/ / Browse

Total Max Concurrent Downloading Tasks 6
The total concurrent downloading tasks allowed regardless of which kind of service (FTP/HTTP, BT, or eDonkey)

Maximum Download Speed per task (0 means no limit) 0 KB/s
Maximum Upload Speed per task (0 means no limit) 10 KB/s
Upper limit per task. Once set, each download or upload task can use a speed less than or equal to the value you set here.

Enable Auto Status Refresh
The downloading task status will be refreshed automatically according to specified rate
Refresh rate: 3 Times/Minute

Send e-mail notification when a downloader task is finished.

Configure Email

5. Click the **Configure Email** button.

The E-mail page displays:

6. Select the **Send E-mail notifications when a downloader task is finished** check box.
7. Click the **Apply** button.
Your settings are saved.

Manage Downloader Tasks

► **To manage downloader tasks:**

1. Launch a web browser on a computer that is not on your home network.
2. Enter **http://www.routerlogin.net**.

A login window opens.

3. Enter the router user name and password.

The user name is **admin**. The default password is **password**. The user name and password are case-sensitive.

The BASIC Home page displays.

4. Select **NETGEAR Downloader (BETA)**.



5. Make any needed changes.
6. Click the **Apply** button.
Your settings are saved.

View Photos on Your USB Device With Kwilt

You can use Kwilt to view photos stored on a USB storage device that is connected to the router. Kwilt is a free app for iOS devices that lets you view photos from different sources.

► **To add the router to your Kwilt account and view photos stored on a USB storage device:**

1. Transfer your photos to a USB storage device.
2. Connect your USB storage device to the router.
3. If your USB device uses a power supply, connect it.

You must use the power supply when you connect the USB device to the router.

Nighthawk X4S AC2600 Smart WiFi Router

When you connect the USB device to the router USB port, it might take up to two minutes before it is ready for sharing. By default, the USB device is available to all computers on your local area network (LAN).

4. Make sure that the router is connected to the Internet.
5. Connect your iOS device to the router's WiFi network.

If you set up a guest network, make sure that you are not connected to the guest network.

6. Download the Kwilt app to your iOS device from the Apple App Store.
7. Launch the Kwilt app on your iOS device.
8. Log in or create a Kwilt account.
9. If you created a new account, authorize your photo streams, add them to your account, and read the tutorial.

The Kwilt timeline page displays.

10. Tap the  **Kwilt** icon.

The Kwilt settings page displays.

11. Tap **PHOTO STREAMS** and tap the  icon.

The ADD PHOTO STREAMS page displays.

12. Scroll down to the STORAGE DEVICES section and tap **KWILT STREAMER**.

The Kwilt Streamer Devices screen displays. Your router displays in the device list.

13. Tap the router and tap the **ADD** button.

The router is added to your account and you can now use the Kwilt app to view the photos stored on the USB storage device, even when you are away from home.

Use the Router as a Media Server

10

The router comes set up to work as a ReadyDLNA media server. You can set up the router to play music from iTunes Server and media from TiVo.

This chapter contains the following sections:

- *Specify ReadyDLNA Media Server Settings* on page 138
- *Play Music From a Storage Device With iTunes Server* on page 138
- *Play Media From a USB Device on TiVo* on page 142

Specify ReadyDLNA Media Server Settings

By default, the router acts as a ReadyDLNA media server, which lets you view movies and photos on DLNA/UPnP AV-compliant media players, such as Xbox360, Playstation, and NETGEAR media players.

► To specify media server settings:

1. Launch a web browser from a computer or WiFi device that is connected to the network.
2. Enter **http://www.routerlogin.net**.

A login window opens.

3. Enter the router user name and password.

The user name is **admin**. The default password is **password**. The user name and password are case-sensitive.

The BASIC Home page displays.

4. Select **ADVANCED > ReadySHARE > Media Server**.

The Media Server (Settings) page displays.

5. Specify the settings:

- **Enable DLNA Media Server.** Select this check box to enable this device to act as a media server.
- **Enable TiVo support.** Select this check box if you want to play ReadyNAS media on your TiVo device. See [Play Media From a USB Device on TiVo](#) on page 142.
- **Media Server Device Name.** Specify the name of the media server.

6. Click the **Apply** button.

Your changes are saved.

Play Music From a Storage Device With iTunes Server

iTunes server lets you play music from a USB device that is connected to a USB port on your router with iTunes on your Windows or Mac computer or with the Apple Remote app on your iPhone or iPad. You can also use the Apple Remote app from an iPhone or iPad to play music on any AirPlay devices, such as Apple TV or AirPlay-supported receivers.



Figure 12. Play music on a USB device with iTunes

Set Up the Router's iTunes Server With iTunes

You can play music from a USB device that is connected to your router with iTunes on your Windows or Mac computer using Home Sharing. To set up Home Sharing, you need an Apple account and the latest version of iTunes installed on your computer.

▶ To set up the router's iTunes server to play music on iTunes:

1. Connect a USB storage device to a USB port on your router.
2. If your USB storage device uses a power supply, connect it.

You must use the power supply when you connect the USB storage device to the router.

When you connect the USB storage device to the router's USB port, it might take up to two minutes before it is ready for sharing. By default, the USB storage device is available to all computers on your local area network (LAN).

3. Launch a web browser from a computer or WiFi device that is connected to your router's network.
4. Enter **<http://www.routerlogin.net>**.

A login window opens.

5. Enter the router user name and password.

The user name is **admin**. The default password is **password**. The user name and password are case-sensitive.

The BASIC Home page displays.

6. Select **ADVANCED > ReadySHARE > Media Server**.

The Media Server (Settings) page displays.

7. Select the **Enable iTunes Media Server (Music Only)** check box.
8. Click the **Apply** button.

Your settings are saved.

9. On your Windows or Mac computer, launch iTunes.
10. Select **File > Home Sharing > Turn On Home Sharing**.

The Home Sharing page displays.

11. Enter your Apple ID email address and password.
12. Click the **Turn On Home Sharing** button.

When Home Sharing is enabled, a **Home Sharing** icon  displays in iTunes.

13. Click the **Home Sharing** icon  and from the menu, select the router.

The music that is on the USB device that is connected to the router displays in iTunes.

Set Up the Router's iTunes Server With the Remote App

You can play music from a USB device that is connected to your router on your iPhone or iPad using the Apple Remote app.

▶ To set up the router's iTunes server to play music on your iPhone or iPad:

1. Connect a USB storage device to a USB port on your router.
2. If your USB storage device uses a power supply, connect it.

You must use the power supply when you connect the USB storage device to the router.

When you connect the USB storage device to the router's USB port, it might take up to two minutes before it is ready for sharing. By default, the USB storage device is available to all computers on your local area network (LAN).

3. Connect your iPhone or iPad to your router's WiFi network.
4. Download the Remote app from the Apple App Store.
5. Launch the Remote app  from your iPhone or iPad.

Nighthawk X4S AC2600 Smart WiFi Router



6. Click the **Add a Device** button.



7. Specify the passcode in the router to set up your iTunes server.
 - a. Launch a web browser from a computer or WiFi device that is connected to your router's network.
 - b. Enter **http://www.routerlogin.net**.

A login window opens.
 - c. Enter the router user name and password.

The user name is **admin**. The default password is **password**. The user name and password are case-sensitive.

The BASIC Home page displays.
 - d. Select **ADVANCED > ReadySHARE > Media Server**.

The Media Server (Settings) page displays.
 - e. Select the **Enable iTunes Media Server (Music Only)** check box.
 - f. Click the **Apply** button.
 - g. Enter the passcode.
 - h. Click the **Allow Control** button.

Nighthawk X4S AC2600 Smart WiFi Router

Your settings are saved.

Your iPhone or iPad pairs with the router and the iTunes Server is ready. The router displays in the Remote app.

8. In the Remote app, tap the router your iPhone or iPad is connected to.

The music that is on the USB device that is connected to the router displays in the app.

Play Media From a USB Device on TiVo

You can set up your TiVo to access media files stored on a USB device that is connected to your router. The TiVo must be on the same network as the router. This feature supports the following file formats:

- **Video.** See and play `mpeg1`, and `mpeg2` files.
- **Music.** See and play MP3 files.
- **Pictures.** View images in `.jpg` format.

You can use the TiVo (Series 2 and later) Home Media Option to play photos and music on your Windows or Mac computer in your TiVo user interface.

Set Up the Router to Work With TiVo

► To set up the router to work with TiVo:

1. Launch a web browser from a computer or WiFi device that is connected to the network.
2. Enter **`http://www.routerlogin.net`**.

A login window opens.

3. Enter the router user name and password.

The user name is **admin**. The default password is **password**. The user name and password are case-sensitive.

The BASIC Home page displays.

4. Select **ADVANCED > ReadySHARE > Media Server**.

The Media Server (Settings) page displays.

5. Make sure that the **Enable TiVo support** check box is selected.
6. If you changed the settings, click the **Apply** button.

Your settings are saved.

Play Videos on TiVo

▶ To play videos:

1. On the TiVo, select **TiVo Central > My Shows**.



2. Go to the bottom of the list and select the router model.

Play Music or View Photos on TiVo

▶ To play music or view photos:

1. On the TiVo, select **TiVo Central > Music, Photos, & Showcases**.



2. Select an item to play or watch.

The ReadySHARE Printer utility lets you share a USB printer that is connected to the USB port on your router. You can share this USB printer among the Windows and Mac computers on your network.

For more information about the features available in the NETGEAR USB Control Center, see the *ReadySHARE Printer User Manual*, which is available at <http://downloadcenter.netgear.com>.

This chapter contains the following sections:

- *Install the Printer Driver and Cable the Printer* on page 145
- *Download the ReadySHARE Printer Utility* on page 145
- *Install the ReadySHARE Printer Utility* on page 145
- *Print Using the NETGEAR USB Control Center* on page 147
- *View or Change the Status of a Printer* on page 147
- *Use the Scan Feature of a Multifunction USB Printer* on page 148
- *Change NETGEAR USB Control Center Settings* on page 148

Install the Printer Driver and Cable the Printer

Some USB printer manufacturers (for example, HP and Lexmark) request that you do not connect the USB cable until the installation software prompts you to do so.

► To install the driver and cable the printer:

1. On each computer on your network that shares the USB printer, install the driver software for the USB printer.
If you cannot locate the printer driver, contact the printer manufacturer.
2. Use a USB printer cable to connect the USB printer to a router USB port.

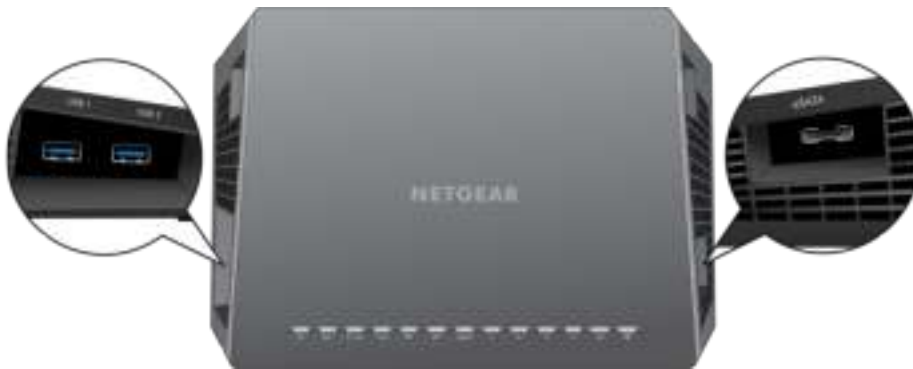

Download the ReadySHARE Printer Utility

The utility works on Windows and Mac computers.

► To download the utility:

1. Visit NETGEAR.com/readysare.
2. Click the **PRINT - Learn how you can print wirelessly from many devices** link.
3. Click one of the following links to download the ReadySHARE Printer utility setup file:
 - **Download PC installer and get started.** This is the utility for Windows computers.
 - **Download Mac installer and get started.** This is the utility for MAC computers.
 - **Download the genie App and get started.** This is the utility for smartphones and tablets.
4. Follow the onscreen instructions to download the ReadySHARE Printer utility.

Install the ReadySHARE Printer Utility

You must install the ReadySHARE Printer utility on each computer that will share the printer. After you install it, the utility displays as NETGEAR USB Control Center on your computer.

► To install the utility:

1. If necessary, unzip the ReadySHARE Printer utility setup file.
2. Double-click the ReadySHARE Printer utility setup file that you downloaded.



3. Follow the wizard instructions to install the NETGEAR USB Control Center.



4. Select a language from the menu and click the **OK** button.



The USB printer connected to the router displays in the NETGEAR USB Control Center window.

Some firewall software, such as Comodo, blocks the NETGEAR USB Control Center from accessing the USB printer. If you do not see the USB printer displayed on the page, you can disable the firewall temporarily to allow the utility to work.

Print Using the NETGEAR USB Control Center

For each computer, after you click the **Connect** and **Disconnect** buttons once, the utility automatically manages the printing queue and handling. By default, the utility starts automatically whenever you log on to Windows and runs in the background.

► To print a document using the NETGEAR USB Control Center:

1. Click the **NETGEAR USB Control Center** icon .
The NETGEAR USB Control Center page displays.
2. Select a printer and click the **Connect** button.
The printer status changes to Manually connected by *Mycomputer*. Now only the computer that you are using can use this printer.
3. Use the print feature in your application to print your document.
The NETGEAR USB Control Center automatically connects your computer to the USB printer and prints the document. If another computer is already connected to the printer, your print job goes into a queue to wait to be printed.
4. If your document does not print, use the NETGEAR USB Control Center to check the printer status.
5. To release the printer so that all computers on the network can use it, click the **Disconnect** button.
The status changes to Available. Now any computers on the network can use the printer.
6. To exit the utility, select **System > Exit**.

View or Change the Status of a Printer

► To view or change the status:

1. Click the **NETGEAR USB Control Center** icon .
The NETGEAR USB Control Center page displays.
The Status column shows the status for each device:
 - **Available.** No print jobs are in progress. You can use the USB printer from any computer in the network.
 - **Connected.** Your computer is connected to the printer and will be released when your print job is done.
 - **Manually Connected by.** Only the connected computer can use the printer.
 - **Waiting to Connect.** Your computer is not connected to the shared printer yet.
2. To print from your computer when the status shows Manually connected by *another computer*, do the following:

- a. Click the **Connect** button on your computer.
On the other user's computer, a message displays that another user wants to connect to the printer.
 - b. On the other user's computer, click the **Accept** button.
The printer is released from the connection and the status changes to Available.
3. To print from your computer when the status shows Waiting to Connect, do the following:
- a. Click the **Connect** button.
The printer status changes to Manually connected by *Mycomputer*. Now only your computer can use the printer.
 - b. To allow the printer to be shared, click the **Disconnect** button.
The printer is released from the connection and the status changes to Available.

Use the Scan Feature of a Multifunction USB Printer

If your USB printer supports scanning, you can also use the USB printer for scanning.

► To use the scan feature of a multifunction USB printer:

1. Click the **NETGEAR USB Control Center** icon .
The NETGEAR USB Control Center page displays.
2. Make sure that the printer status shows as Available.
3. Click the **Network Scanner** button.
4. If a Select a Device window opens, select the scanner and click the **OK** button.
The scanner window opens so that you can use the USB printer for scanning.

Change NETGEAR USB Control Center Settings

You can stop the NETGEAR USB Control Center from starting automatically when you log in to Windows. You can also change the language and specify the time-out to release the printer connection.

Turn Off Automatic Startup for NETGEAR USB Control Center

You can stop the NETGEAR USB Control Center from starting automatically when you log in to Windows.

► **To turn off automatic NETGEAR USB Control Center startup:**

1. Click the **NETGEAR USB Control Center** icon .
The NETGEAR USB Control Center page displays.
2. Select **Tools > Configuration**.
The Control Center - Configuration page displays.
3. Clear the **Automatically execute when logging on Windows** check box.
4. Click the **OK** button.
Your settings are saved.

Change the Language for the NETGEAR USB Control Center

► **To change the language:**

1. Click the **NETGEAR USB Control Center** icon .
The NETGEAR USB Control Center page displays.
2. Select **Tools > Configuration**.
The NETGEAR USB Control Center page displays.
3. From the **Language** menu, select a language.
4. Click the **OK** button.
The next time NETGEAR USB Control Center starts, the language changes.

Specify the USB Control Center Time-Out

Specify the time-out to release the printer connection.

► **To specify the time-out:**

1. Click the **NETGEAR USB Control Center** icon .
The NETGEAR USB Control Center page displays.
2. Select **Tools > Configuration**.
The NETGEAR USB Control Center page displays.
3. In the **Timeout** field, type the number of minutes.

Nighthawk X4S AC2600 Smart WiFi Router

The time-out is the number of minutes that a computer holds its connection to the printer when the connection isn't being used.

4. Click the **OK** button.

Your settings are saved.

Customize Internet Traffic Rules for Ports 12

You can use port forwarding and port triggering to set up rules for Internet traffic. You need networking knowledge to set up these features.

This chapter includes the following sections:

- *Port Forwarding to a Local Server* on page 152
- *Port Triggering* on page 156

Port Forwarding to a Local Server

If your home network includes a server, you can allow certain types of incoming traffic to reach the server. For example, you might want to make a local web server, FTP server, or game server visible and available to the Internet.

The router can forward incoming traffic with specific protocols to computers on your local network. You can specify the servers for applications and you can also specify a default DMZ server to which the router forwards all other incoming protocols.

Set Up Port Forwarding to a Local Server

► To forward specific incoming protocols:

1. Decide which type of service, application, or game you want to provide.
2. Find the local IP address of the computer on your network that will provide the service.

You can usually find this information by contacting the publisher of the application or user groups or news groups.

The server computer must always use the same IP address.

3. Assign the server computer a reserved IP address.

See [Manage Reserved LAN IP Addresses](#) on page 64.

4. Launch a web browser from a computer or WiFi device that is connected to the network.

5. Enter **http://www.routerlogin.net**.

A login window opens.

6. Enter the router user name and password.

The user name is **admin**. The default password is **password**. The user name and password are case-sensitive.

The BASIC Home page displays.

7. Select **ADVANCED > Advanced Setup > Port Forwarding/Port Triggering**.



8. Leave the **Port Forwarding** radio button selected as the service type.
9. From the **Service Name** menu, select the service name.

If the service that you want to add is not in the menu, create a custom service. See [Add a Custom Port Forwarding Service](#) on page 153.

10. In the **Server IP Address** field, enter the IP address of the computer that will provide the service.

11. Click the **Add** button.

The service displays in the menu.

Add a Custom Port Forwarding Service

► To add a custom service:

1. Find out which port number or range of numbers the application uses.

You can usually find this information by contacting the publisher of the application or user groups or news groups.

2. Launch a web browser from a computer or WiFi device that is connected to the network.

3. Enter **http://www.routerlogin.net**.

A login window opens.

4. Enter the router user name and password.

The user name is **admin**. The default password is **password**. The user name and password are case-sensitive.

The BASIC Home page displays.

5. Select **ADVANCED > Advanced Setup > Port Forwarding/Port Triggering**.

The Port Forwarding/Port Triggering page displays.

6. Leave the **Port Forwarding** radio button selected as the service type.

7. Click the **Add Custom Service** button.

Ports - Custom Services

Cancel Add

Service Name

Protocol TCP/UDP

External port range

Please specify ports and port ranges split by commas, example: 31, 50 - 80, 95580 - 65510

Use the same port range for internal port

Internal port range

Please specify ports and port ranges split by commas, example: 31, 50 - 80, 95580 - 65510

Internal IP address

Or select from currently attached devices

IP Address	Device Name
192.168.1.2	TECHFIBR

8. In the **Service Name** field, enter a descriptive name.

9. From the **Protocol** menu, select the protocol.

If you are unsure, select **TCP/UDP**.

10. In the **External port range** field, enter the port numbers.

11. Specify the internal ports by one of these methods:

- Leave the **Use the same port range for Internal port** check box selected.
- Type the port numbers in the **Internal Port Range** field.

You can enter a port range and fixed ports in one rule. For example, external (30-50, 78, 100-102), internal (40-60, 99, 200-202). With this rule, external ports 30-50 are forwarded to internal ports 40-60.

12. In the **Internal IP address** field, type the IP address or select the radio button for an attached device listed in the table.

13. Click the **Apply** button.

The service is now in the list on the Port Forwarding/Port Triggering page.

Edit a Port Forwarding Service

► To edit a port forwarding entry:

1. Launch a web browser from a computer or WiFi device that is connected to the network.
2. Enter **http://www.routerlogin.net**.

A login window opens.

3. Enter the router user name and password.

The user name is **admin**. The default password is **password**. The user name and password are case-sensitive.

The BASIC Home page displays.

4. Select **ADVANCED > Advanced Setup > Port Forwarding/Port Triggering**.

The Port Forwarding/Port Triggering page displays.

5. Leave the **Port Forwarding** radio button selected as the service type.

6. In the table, select the radio button next to the service name.

7. Click the **Edit Service** button.

The Ports - Custom Services page displays.

8. Change the settings as needed.

9. Click the **Apply** button.

Your settings are saved.

Delete a Port Forwarding Entry

▶ To delete a port forwarding entry:

1. Launch a web browser from a computer or WiFi device that is connected to the network.
2. Enter **http://www.routerlogin.net**.
A login window opens.
3. Enter the router user name and password.
The user name is **admin**. The default password is **password**. The user name and password are case-sensitive.
The BASIC Home page displays.
4. Select **ADVANCED > Advanced Setup > Port Forwarding/Port Triggering**.
The Port Forwarding/Port Triggering page displays.
5. Leave the **Port Forwarding** radio button selected.
6. In the table, select the radio button next to the service name.
7. Click the **Delete Service** button.
The service is deleted.

Application Example: Make a Local Web Server Public

If you host a web server on your local network, you can use port forwarding to allow web requests from anyone on the Internet to reach your web server.

▶ To make a local web server public:

1. Assign your web server either a fixed IP address or a dynamic IP address using DHCP address reservation.
In this example, your router always gives your web server an IP address of 192.168.1.33.
2. On the Port Forwarding/Port Triggering page, configure the router to forward the HTTP service to the local address of your web server at **192.168.1.33**.
HTTP (port 80) is the standard protocol for web servers.
3. (Optional) Register a host name with a Dynamic DNS service and specify that name on the Dynamic DNS page of the router.
Dynamic DNS makes it much easier to access a server from the Internet because you can type the name in the Internet browser. Otherwise, you must know the IP address that the ISP assigned, which typically changes.

How the Router Implements the Port Forwarding Rule

The following sequence shows the effects of a port forwarding rule:

1. When you type the URL `www.example.com` in your browser, the browser sends a web page request message with the following destination information:
 - **Destination address.** The IP address of `www.example.com`, which is the address of your router.
 - **Destination port number.** 80, which is the standard port number for a web server process.
2. Your router receives the message and finds your port forwarding rule for incoming port 80 traffic.
3. The router changes the destination in the message to IP address `192.168.1.123` and sends the message to that computer.
4. Your web server at IP address `192.168.1.123` receives the request and sends a reply message to your router.
5. Your router performs Network Address Translation (NAT) on the source IP address and sends the reply through the Internet to the computer or WiFi device that sent the web page request.

Port Triggering

Port triggering is a dynamic extension of port forwarding that is useful in these cases:

- An application must use port forwarding to more than one local computer (but not simultaneously).
- An application must open incoming ports that are different from the outgoing port.

With port triggering, the router monitors traffic to the Internet from an outbound “trigger” port that you specify. For outbound traffic from that port, the router saves the IP address of the computer that sent the traffic. The router temporarily opens the incoming port or ports that you specify in your rule and forwards that incoming traffic to that destination.

Port forwarding creates a static mapping of a port number or range of ports to a single local computer. Port triggering can dynamically open ports to any computer when needed and close the ports when they are no longer needed.

Note If you use applications such as multiplayer gaming, peer-to-peer connections, real-time communications such as instant messaging, or remote assistance (a feature in Windows XP), enable Universal Plug and Play (UPnP). See *Improve Network Connections With Universal Plug and Play* on page 92.

Add a Port Triggering Service

► To add a port triggering service:

1. Launch a web browser from a computer or WiFi device that is connected to the network.
2. Enter `http://www.routerlogin.net`.

A login window opens.

Nighthawk X4S AC2600 Smart WiFi Router

3. Enter the router user name and password.

The user name is **admin**. The default password is **password**. The user name and password are case-sensitive.
The BASIC Home page displays.

4. Select **ADVANCED > Advanced Setup > Port Forwarding/Port Triggering**.

The Port Forwarding/Port Triggering page displays.

5. Select the **Port Triggering** radio button.

Port Forwarding / Port Triggering

Cancel Apply

Please select the service type.

Port Forwarding

Port Triggering

Disable Port Triggering

Port Triggering Time-out (in minutes) 20

Port Triggering Portmap Table

#	Enable	Service Name	Service Type	Inbound Connection	Service User
---	--------	--------------	--------------	--------------------	--------------

+ Add Service Edit Service X Delete Service

6. Click the **Add Service** button.

Port Triggering - Services

Cancel Apply

Service Name

Service User Any

Service Type TCP

Triggering Port (1-65535)

Inbound Connection

Connection Type TCP/UDP

Starting Port (1-65535)

Ending Port (1-65535)

7. In the **Service Name** field, type a descriptive service name.
8. From the **Service User** menu, select a user option:
 - **Any** (the default) allows any computer on the Internet to use this service.
 - **Single address** restricts the service to a particular computer.
9. From the **Service Type** menu, select **TCP** or **UDP** or **TCP/UDP** (both).

If you are not sure, select **TCP/UDP**.

10. In the **Triggering Port** field, enter the number of the outbound traffic port that will open the inbound ports.
11. In the **Connection Type**, **Starting Port**, and **Ending Port** fields, enter the inbound connection information.
12. Click the **Apply** button.

The service is now in the Portmap Table. You must enable port triggering before the router uses port triggering. See [Enable Port Triggering](#) on page 158.

Enable Port Triggering

► To enable port triggering:

1. Launch a web browser from a computer or WiFi device that is connected to the network.
2. Enter **http://www.routerlogin.net**.

A login window opens.

3. Enter the router user name and password.

The user name is **admin**. The default password is **password**. The user name and password are case-sensitive.

The BASIC Home page displays.

4. Select **ADVANCED > Advanced Setup > Port Forwarding/Port Triggering**.

The Port Forwarding/Port Triggering page displays.

5. Select the **Port Triggering** radio button.



6. Clear the **Disable Port Triggering** check box.

If this check box is selected, the router does not use port triggering even if you specified port triggering settings.

7. In the **Port Triggering Timeout** field, enter a value up to 9999 minutes.

This value controls how long the inbound ports stay open when the router detects no activity. This value is required because the router cannot detect when the application terminates.

8. Click the **Apply** button.

Your settings are saved.

Application Example: Port Triggering for Internet Relay Chat

Some application servers, such as FTP and IRC servers, send replies to multiple port numbers. Using port triggering, you can tell the router to open more incoming ports when a particular outgoing port starts a session.

An example is Internet Relay Chat (IRC). Your computer connects to an IRC server at destination port 6667. The IRC server not only responds to your originating source port but also sends an “identify” message to your computer on port 113. Using port triggering, you can tell the router, “When you initiate a session with destination port 6667, you must also allow incoming traffic on port 113 to reach the originating computer.” The following sequence shows the effects of this port triggering rule:

1. You open an IRC client program to start a chat session on your computer.
2. Your IRC client composes a request message to an IRC server using a destination port number of 6667, the standard port number for an IRC server process. Your computer then sends this request message to your router.
3. Your router creates an entry in its internal session table describing this communication session between your computer and the IRC server. Your router stores the original information, performs Network Address Translation (NAT) on the source address and port, and sends this request message through the Internet to the IRC server.
4. Noting your port triggering rule and observing the destination port number of 6667, your router creates another session entry to send any incoming port 113 traffic to your computer.
5. The IRC server sends a return message to your router using the NAT-assigned source port (for example, port 33333) as the destination port and sends an “identify” message to your router with destination port 113.
6. When your router receives the incoming message to destination port 33333, it checks its session table to see if a session is active for port number 33333. Finding an active session, the router restores the original address information replaced by NAT and sends this reply message to your computer.
7. When your router receives the incoming message to destination port 113, it checks its session table and finds an active session for port 113 associated with your computer. The router replaces the message’s destination IP address with your computer’s IP address and forwards the message to your computer.
8. When you finish your chat session, your router eventually senses a period of inactivity in the communications. The router then removes the session information from its session table and incoming traffic is no longer accepted on port numbers 33333 or 113.

You can use OpenVPN software to remotely access your router using virtual private networking (VPN). This chapter explains how to set up and use VPN access.

The chapter includes the following sections:

- *Set Up a VPN Connection* on page 161
- *Specify VPN Service in the Router* on page 161
- *Install OpenVPN Software* on page 162
- *Use a VPN Tunnel on Your Windows Computer* on page 167
- *Use VPN to Access the Router's USB Device and Media* on page 169
- *Use a VPN Tunnel to Access Your Internet Service at Home* on page 171
- *Change VPN Pass-Through Settings* on page 171

Set Up a VPN Connection

A virtual private network (VPN) lets you use the Internet to securely access your network when you aren't home.

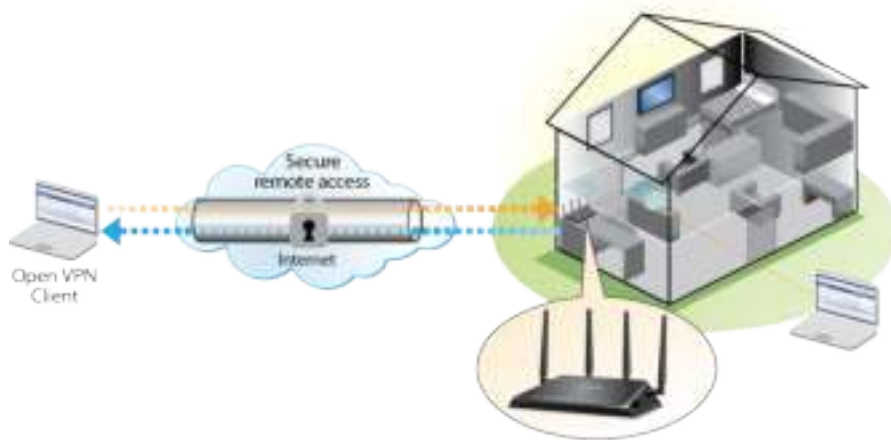

Figure 13. VPN provides a secure tunnel between your home network and a remote computer

This type of VPN access is called a client-to-gateway tunnel. The computer is the client, and the router is the gateway. To use the VPN feature, you must log in to the router and enable VPN, and you must install and run VPN client software on the computer.

VPN uses DDNS or a static IP address to connect with your router.

To use a DDNS service, register for an account with a host name (sometimes called a domain name). You use the host name to access your network. The router supports these accounts: NETGEAR, No-IP, and Dyn.

If your Internet service provider (ISP) assigned a static WAN IP address (such as 50.196.x.x or 10.x.x.x) that never changes to your Internet account, the VPN can use that IP address to connect to your home network.

Specify VPN Service in the Router

You must specify the VPN service settings in the router before you can use a VPN connection.

► To specify the VPN service:

1. Launch a web browser from a computer or WiFi device that is connected to the network.
2. Enter **http://www.routerlogin.net**.

A login window opens.

3. Enter the router user name and password.

The user name is **admin**. The default password is **password**. The user name and password are case-sensitive.

The BASIC Home page displays.

4. Select **ADVANCED > Advanced Setup > VPN Service**.

The VPN page displays.

5. Select the **Enable VPN Service** check box.

By default, the VPN uses the UDP service type and uses port 12974. If you want to customize the service type and port, we recommend that you change these settings before you install the OpenVPN software.

6. To change the service type, scroll down and select the **TCP** radio button.
7. To change the port, scroll down to the **Service Port** field, and type the port number that you want to use.
8. Click the **Apply** button.

Your changes are saved. VPN is enabled in the router, but you must install and set up OpenVPN software on your computer before you can use a VPN connection.

Install OpenVPN Software

You must install this software on each Windows computer, Mac computer, iOS device, or Android device that you plan to use for VPN connections to your router.

Install OpenVPN Software on Your Windows Computer

You must install this software on each Windows computer that you plan to use for VPN connections to your router.

► To install VPN client software on your Windows computer:

1. Launch a web browser from a computer or WiFi device that is connected to the network.
2. Enter **http://www.routerlogin.net**.

A login window opens.

3. Enter the router user name and password.

The user name is **admin**. The default password is **password**. The user name and password are case-sensitive.

The BASIC Home page displays.

4. Select **ADVANCED > Advanced Setup > VPN Service**.

The VPN Service page displays.

5. Make sure that the **Enable VPN Service** check box is selected.
6. Specify any VPN service settings on the page.

For more information, see *Specify VPN Service in the Router* on page 161.

Nighthawk X4S AC2600 Smart WiFi Router

7. Click the **For Windows** button to download the OpenVPN configuration files.
8. Visit openvpn.net/index.php/download/community-downloads.html to download the OpenVPN client utility.
9. In the Windows Installer section of the page, double-click the **openVPN-install-xxx.exe** link.
10. Download and install the Open VPN software on your computer, click the **openVPN-install-xxx.exe** file.



11. Click the **Next** button.
12. Read the License Agreement and click the **I Agree** button.



13. Leave the check boxes selected as shown, and click the **Next** button.

Nighthawk X4S AC2600 Smart WiFi Router

14. To specify the destination folder, click the **Browse** button and select a destination folder.



15. Click the **Install** button.

The window displays the progress of the installation and then displays the final installation page.



16. Click the **Finish** button.
17. Unzip the configuration files that you downloaded and copy them to the folder where the VPN client is installed on your device.

For a client device with Windows 64-bit system, the VPN client is installed at `C:\Program files\OpenVPN\config\` by default.
18. For a client device with Windows, modify the VPN interface name to **NETGEAR-VPN**:
 - a. On your computer, go to the Networks page. If you are using Windows 10, select **Control Panel > Network and Sharing Center > Change adapter settings**.
 - b. In the local area connection list, find the local area connection with the device name **TAP-Windows Adapter**.
 - c. Select the local area connection and change its name (not its device name) to **NETGEAR-VPN**.

If you do not change the VPN interface name, the VPN tunnel connection will fail.

For more information about using OpenVPN on your Windows computer, visit <https://openvpn.net/index.php/open-source/documentation/howto.html#quick>.

Install OpenVPN Software on Your Mac Computer

You must install this software on each Mac computer that you plan to use for VPN connections to your router.

► To install VPN client software on your Mac computer:

1. Launch a web browser from a computer or WiFi device that is connected to the network.
2. Enter **http://www.routerlogin.net**.

A login window opens.

3. Enter the router user name and password.

The user name is **admin**. The default password is **password**. The user name and password are case-sensitive.

The BASIC Home page displays.

4. Select **ADVANCED > Advanced Setup > VPN Service**.

The VPN Service page displays.

5. Make sure that the **Enable VPN Service** check box is selected.
6. Specify any VPN service settings on the page.

For more information, see *Specify VPN Service in the Router* on page 161.

7. Click the **For non-Windows** button to download the OpenVPN configuration files.
8. Visit <https://tunnelblick.net/index.html> to download the OpenVPN client utility for Mac OS X.
9. Download and install the file.
10. Unzip the configuration files that you downloaded and copy them to the folder where the VPN client is installed on your device.

The client utility must be installed by a user with administrative privileges.

For more information about using OpenVPN on your Mac computer, visit

<https://openvpn.net/index.php/access-server/docs/admin-guides/183-how-to-connect-to-access-server-from-a-mac.html>.

Install OpenVPN Software on an iOS Device

You must install this software on each iOS device that you plan to use for VPN connections to your router.

► To install VPN client software on an iOS device:

1. Launch a web browser from a computer or WiFi device that is connected to the network.
2. Enter **<http://www.routerlogin.net>**.

A login window opens.

3. Enter the router user name and password.

The user name is **admin**. The default password is **password**. The user name and password are case-sensitive.

The BASIC Home page displays.

4. Select **ADVANCED > Advanced Setup > VPN Service**.

The VPN Service page displays.

5. Make sure that the **Enable VPN Service** check box is selected.
6. Specify any VPN service settings on the page.

For more information, see *Specify VPN Service in the Router* on page 161.

7. Click the **For Smart Phone** button to download the OpenVPN configuration files.
8. On your iOS device, download and install the OpenVPN Connect app from the Apple app store.
9. On your computer, unzip the configuration files that you downloaded and send the files to your iOS device.

Note that when you open the .ovpn file, a list of apps displays. Select the OpenVPN Connect app to open the .ovpn file.

For more information about using OpenVPN on your iOS device, visit http://www.vpngate.net/en/howto_openvpn.aspx#ios.

Install OpenVPN Software on an Android Device

You must install this software on each Android device that you plan to use for VPN connections to your router.

► To install VPN client software on an Android device:

1. Launch a web browser from a computer or WiFi device that is connected to the network.
2. Enter **<http://www.routerlogin.net>**.

A login window opens.

3. Enter the router user name and password.

The user name is **admin**. The default password is **password**. The user name and password are case-sensitive.

The BASIC Home page displays.

4. Select **ADVANCED > Advanced Setup > VPN Service**.

The VPN Service page displays.

5. Make sure that the **Enable VPN Service** check box is selected.
6. Specify any VPN service settings on the page.

For more information, see *Specify VPN Service in the Router* on page 161.

7. Click the **For Smart Phone** button to download the OpenVPN configuration files.
8. On your Android device, download and install the OpenVPN Connect app from the Google Play Store.
9. On your computer, unzip the configuration files that you downloaded and send the files to your Android device.
10. Open the files on your Android device.
11. Open the .ovpn file using the OpenVPN Connect app.

For more information about using OpenVPN on your Android device, visit

http://www.vpngate.net/en/howto_openvpn.aspx#android.

Use a VPN Tunnel on Your Windows Computer

After you set up the router to use VPN and install the OpenVPN application on your computer, you can open a VPN tunnel from your computer to your router over the Internet.

For the VPN tunnel to work, the local LAN IP address of the remote router must use a different LAN IP scheme from that of the local LAN where your VPN client computer is connected. If both networks use the same LAN IP scheme, when the VPN tunnel is established, you cannot access your home router or your home network with the OpenVPN software.

The default LAN IP address scheme for the router is 192.x.x.x. The most common IP schemes are 192.x.x.x, 172.x.x.x, and 10.x.x.x. If you experience a conflict, change the IP scheme either for your home network or for the network with the client VPN computer. For information about changing these settings, see *Change the LAN TCP/IP Settings* on page 60.

► To open a VPN tunnel:

1. Launch the OpenVPN application with administrator privileges.



The **OpenVPN** icon displays in the Windows taskbar.

Tip You can create a shortcut to the VPN program, then use the shortcut to access the settings and select the **run as administrator** check box. Then every time you use this shortcut, OpenVPN automatically runs with administrator privileges.

2. Right-click the **OpenVPN** icon.



3. Select **Connect**.

The VPN connection is established. You can do the following:

- Launch a web browser and log in to your router.
- Use Windows file manager to access the router's USB device and download files.

Use VPN to Access the Router's USB Device and Media

► To access a USB device and download files:

1. In Windows file manager, select the **Network** folder.



The network resources display. The **ReadySHARE** icon is in the Computer section and the remote router icon is in the Media Devices section (if DLNA is enabled in the router).

2. If the icons do not display, click the **Refresh** button to update the screen.

If the local LAN and the remote LAN are using the same IP scheme, the remote router icon does not display in the Media Devices and Network Infrastructure sections.

3. To access the USB device, click the **ReadySHARE** icon.
4. To access media on the router's network, click the remote router icon.

Use VPN to Access Your Internet Service at Home

When you're away from home and you access the Internet, you usually use a local Internet service provider. For example, at a coffee shop you might be given a code that lets you use the coffee shop's Internet service account to surf the web.

Nighthawk lets you use a VPN connection to access your own Internet service when you're away from home. You might want to do this if you travel to a geographic location that doesn't support all the Internet services that you use at home. For example, your Netflix account might work at home but not in a different country.

Set Up VPN Client Internet Access in the Router

By default, the router is set up to allow VPN connections only to your home network, but you can change the settings to allow Internet access. Accessing the Internet remotely through a VPN might be slower than accessing the Internet directly.

► To allow VPN clients to use your home Internet service:

1. Launch a web browser from a computer or WiFi device that is connected to the network.
2. Enter **http://www.routerlogin.net**.

A login window opens.

Nighthawk X4S AC2600 Smart WiFi Router

3. Enter the router user name and password.

The user name is **admin**. The default password is **password**. The user name and password are case-sensitive.
The BASIC Home page displays.

4. Select **ADVANCED > Advanced Setup > VPN Service**.

The VPN page displays.

5. Select the **Enable VPN Service** radio button.

6. Scroll down to the Clients will use this VPN connection to access section, and select the **All sites on the Internet & Home Network** radio button.

When you access the Internet with the VPN connection, instead of using a local Internet service, you use the Internet service from your home network.

7. Click the **Apply** button.

Your settings are saved.

8. Click the **For Windows** or **For Non Windows** button and download the configuration files for your VPN clients.

9. Unzip the configuration files and copy them to the folder where the VPN client is installed on your device.

For a client device with Windows 64-bit system, the VPN client is installed at `C:\Program files\OpenVPN\config\` by default.

Block VPN Client Internet Access in the Router

By default, the router is set up to allow VPN connections only to your home network, not to the Internet service for your home network. If you changed this setting to allow Internet access, you can change it back.

► To allow VPN clients to access only your home network:

1. Launch a web browser from a computer or WiFi device that is connected to the network.
2. Enter **http://www.routerlogin.net**.

A login window opens.

3. Enter the router user name and password.

The user name is **admin**. The default password is **password**. The user name and password are case-sensitive.
The BASIC Home page displays.

4. Select **ADVANCED > Advanced Setup > VPN Service**.

The VNP page displays.

5. Select the **Enable VPN Service** radio button.

6. Scroll down to the Clients will use this VPN connection to access section, and select the **Home Network only** radio button.

This is the default setting. The VPN connection is only to your home network, not to the Internet service for your home network.

7. Click the **Apply** button.

Your settings are saved.

8. Click **For Windows** or **For Non Windows** button and download the configuration files for your VPN clients.
9. Unzip the configuration files and copy them to the folder where the VPN client is installed on your device.

For a client device with Windows 64-bit system, the VPN client is installed at `C:\Program files\OpenVPN\config\` by default.

Use a VPN Tunnel to Access Your Internet Service at Home

► To access your Internet service:

1. Set up the router to allow VPN access to your Internet service.
See *Set Up VPN Client Internet Access in the Router* on page 169.
2. On your computer, launch the OpenVPN application.
The **OpenVPN** icon displays in the Windows taskbar.
3. Right-click the icon and select **Connect**.
4. When the VPN connection is established, launch your Internet browser.

Change VPN Pass-Through Settings

This feature is available only in Brazil, Russia, India, and China (the BRIC region).

When Network Address Translation (NAT) is enabled in the router, the router filters encrypted tunnel packets through NAT, causing these packets to become invalid. VPN pass-through allows encrypted tunnel packets to go through without being filtered and is enabled by default for IPSec, PPTP, and L2TP packets. Do not disable VPN pass-through for IPSec, PPTP, or L2TP unless a specific reason exists.

► To change the VPN pass-through settings:

1. Launch a web browser from a computer or WiFi device that is connected to the network.
2. Enter **http://www.routerlogin.net**.
A login window opens.
3. Enter the router user name and password.

Nighthawk X4S AC2600 Smart WiFi Router

The user name is **admin**. The default password is **password**. The user name and password are case-sensitive. The BASIC Home page displays.

4. Select **ADVANCED > Setup > WAN Setup**.

WAN Setup

Disable Port Scan and DoS Protection

Default DNS Server: [] [] [] []

Required to Plug in Internet Port

Disable NAT Proxying

NAT Bypass (NAT): []

NAT Filtering: Disabled Open

Disable SIP ALG

VPN Pass-Through

IPSec Pass-Through: Enable Disable

PPTP Pass-Through: Enable Disable

L2TP Pass-Through: Enable Disable

5. To disable VPN pass-through for one or more protocols, select the corresponding **Disable** radio buttons in the VPN Pass-Through section.

By default, VPN pass-through is enabled for all protocols for which the router supports pass-through (IPSec, PPTP, and L2TP).

6. Click the **Apply** button.

Your settings are saved.

This chapter provides information to help you diagnose and solve problems you might experience with your router. If you do not find the solution here, check the NETGEAR support site at <http://support.netgear.com> for product and contact information.

The chapter contains the following sections:

- *Quick Tips* on page 174
- *Troubleshoot With the LEDs* on page 174
- *You Cannot Log In to the Router* on page 176
- *You Cannot Access the Internet* on page 177
- *Troubleshoot Internet Browsing* on page 178
- *Changes Are Not Saved* on page 178
- *Troubleshoot WiFi Connectivity* on page 179
- *Troubleshoot Your Network Using the Ping Utility* on page 179

Quick Tips

This section describes tips for troubleshooting some common problems.

Sequence to Restart Your Network

If you must restart your network, follow this sequence:

1. Turn off and unplug the modem.
2. Turn off the router.
3. Plug in the modem and turn it on. Wait two minutes.
4. Turn on the router and wait two minutes.

Check Ethernet Cable Connections

If your device does not power on, make sure that the Ethernet cables are securely plugged in. The Internet LED on the router is lit if the Ethernet cable connecting the router and the modem is plugged in securely and the modem and router are turned on. If one or more powered-on computers are connected to the router by an Ethernet cable, the corresponding numbered router LAN port LEDs light.

WiFi Settings

Make sure that the WiFi settings in the computer and router match exactly. The WiFi network name (SSID) and WiFi security settings of the router and WiFi computer must match exactly.

If you set up an access list on the Advanced Wireless Settings page, you must add each WiFi computer's MAC address to the router's access list.

Network Settings

Make sure that the network settings of the computer are correct. Wired computers and computers that are connected over WiFi must use network IP addresses on the same network as the router. The simplest way to do this is to configure each computer to obtain an IP address automatically using DHCP.

Some service providers require you to use the MAC address of the computer initially registered on the account. You can view the MAC address on the Attached Devices page.

Troubleshoot With the LEDs

By default, the router is set with standard LED settings. If you turned off the LEDs except the Power LED, you must return the LEDs to their standard settings for troubleshooting. For information about controlling the LED settings, see [Turn the LEDs On or Off](#) on page 12.

Standard LED Behavior When the Router Is Powered On

After you turn on power to the router, verify that the following sequence of events occurs:

1. When power is first applied, verify that the Power LED  is lit.
2. After about two minutes, verify the following:
 - The Power LED is solid white.
 - The Internet LED is lit.
 - The WiFi LED is lit unless you turned off the WiFi radio.

You can use the LEDs on the front panel of the router for troubleshooting.

Power LED Is Off or Blinking

This could occur for a number of reasons. Check the following:

- Make sure that the power adapter is securely connected to your router and securely connected to a working power outlet.
- Make sure that you are using the power adapter that NETGEAR supplied for this product.
- If the Power LED blinks slowly and continuously, the router firmware is corrupted. This can happen if a firmware upgrade is interrupted, or if the router detects a problem with the firmware. If the error persists, it is likely that a hardware problem exists. For recovery instructions, or help with a hardware problem, contact technical support at netgear.com/support.

Power LED Stays Amber

When the router is turned on, the Power LED lights amber for up to two minutes and then turns white. If the LED does not turn white, this indicates a problem with the router.

If the Power LED is still amber three minutes after you turn on power to the router, do the following:

- Cycle the power to see if the router recovers.
- Press and hold the **Reset** button to return the router to its factory settings. For more information, see [Factory Settings](#) on page 183.

If the error persists, a hardware problem might be the cause. Contact technical support at netgear.com/support.

LEDs Never Turn Off

When the router is turned on, the LEDs light for about 10 seconds and then turn off. If all the LEDs stay on, this indicates a fault within the router.

If all LEDs are still lit one minute after power-up, do the following:

- Cycle the power to see if the router recovers.
- Press and hold the **Reset** button to return the router to its factory settings. For more information, see [Factory Settings](#) on page 183.

If the error persists, a hardware problem might be the cause. Contact technical support at netgear.com/support.

Internet or Ethernet Port LEDs Are Off

If either the Ethernet port LEDs or the Internet LED does not light when the Ethernet connection is made, check the following:

- Make sure that the Ethernet cable connections are secure at the router and at the modem or computer.
- Make sure that power is turned on to the connected modem or computer.
- Be sure that you are using the correct cable.

When you connect the router's Internet port to a modem, use the cable that was supplied with the modem. This cable can be a standard straight-through Ethernet cable or an Ethernet crossover cable.

WiFi LED Is Off

If the WiFi LED stays off, check to see if someone pressed the **WiFi On/Off** button on the router. This button turns the WiFi radios in the router on and off. The WiFi LED is lit when the WiFi radios are turned on.

You Cannot Log In to the Router

If you are unable to log in to the router from a computer on your local network, check the following:

- If you are using an Ethernet-connected computer, check the Ethernet connection between the computer and the router.
- Make sure that the IP address of your computer is on the same subnet as the router. If you are using the recommended addressing scheme, your computer's address is in the range of 192.168.1.2 to 192.168.1.254.
- If your computer's IP address is shown as 169.254.x.x, recent versions of Windows and Mac OS generate and assign an IP address if the computer cannot reach a DHCP server. These autogenerated addresses are in the range of 169.254.x.x. If your IP address is in this range, check the connection from the computer to the router, and reboot your computer.
- If your router's IP address was changed and you do not know the current IP address, clear the router's configuration to factory defaults. This sets the router's IP address to 192.168.1.1. For more information, see [Factory Settings](#) on page 183.
- Make sure that Java, JavaScript, or ActiveX is enabled in your browser. If you are using Internet Explorer, click the **Refresh** button to be sure that the Java applet is loaded.
- Try quitting the browser and launching it again.
- Make sure that you are using the correct login information. The user name is **admin**, and the default password is **password**. Make sure that Caps Lock is off when you enter this information.
- If you are attempting to set up your NETGEAR router as a replacement for an ADSL gateway in your network, the router cannot perform many gateway services. For example, the router cannot convert ADSL or cable data into Ethernet networking information. NETGEAR does not support such a configuration.

You Cannot Access the Internet

If you can access your router but not the Internet, check to see if the router can obtain an IP address from your Internet service provider (ISP). Unless your ISP provides a fixed IP address, your router requests an IP address from the ISP. You can determine whether the request was successful using the **ADVANCED** Home page.

► To check the WAN IP address:

1. Launch a web browser from a computer or WiFi device that is connected to the network.
2. Select an external site such as netgear.com.
3. Type **http://www.routerlogin.net**.

A login window opens.

4. Enter the router user name and password.

The user name is **admin**. The default password is **password**. The user name and password are case-sensitive.

The **BASIC** Home page displays.

5. Click the **ADVANCED** tab.

The **ADVANCED** Home page displays.

6. Check to see that an IP address is shown for the Internet port. If 0.0.0.0 is shown, your router did not obtain an IP address from your ISP.

If your router cannot obtain an IP address from the ISP, you might need to force your cable or DSL modem to recognize your new router by restarting your network. For more information, see [Sequence to Restart Your Network](#) on page 174.

If your router is still unable to obtain an IP address from the ISP, the problem might be one of the following:

- Your Internet service provider (ISP) might require a login program. Ask your ISP whether they require PPP over Ethernet (PPPoE) or some other type of login.
- If your ISP requires a login, the login name and password might be set incorrectly.
- Your ISP might check for your computer's host name. Assign the computer host name of your ISP account as the account name on the Internet Setup page.
- If your ISP allows only one Ethernet MAC address to connect to Internet and checks for your computer's MAC address, do one of the following:
 - Inform your ISP that you bought a new network device and ask them to use the router's MAC address.
 - Configure your router to clone your computer's MAC address.

If your router obtained an IP address, but your computer does not load any web pages from the Internet, it might be for one or more of the following reasons:

- Your computer might not recognize any DNS server addresses.

A DNS server is a host on the Internet that translates Internet names (such as www addresses) to numeric IP addresses. Typically, your ISP provides the addresses of one or two DNS servers for your use. If you entered a DNS address during the router's configuration, reboot your computer, and verify the DNS address. You can configure your computer manually with DNS addresses, as explained in your operating system documentation.

- The router might not be configured as the TCP/IP gateway on your computer.
If your computer obtains its information from the router by DHCP, reboot the computer and verify the gateway address.
- You might be running login software that is no longer needed.
If your ISP provided a program to log you in to the Internet (such as WinPoET), you no longer need to run that software after installing your router. You might need to go to Internet Explorer and select **Tools > Internet Options**, click the **Connections** tab, and select **Never dial a connection**. Other browsers provide similar options.

Troubleshoot Internet Browsing

If your router can obtain an IP address but your computer is unable to load any web pages from the Internet, it might be for the following reasons:

- The traffic meter is enabled, and the limit was reached.
By configuring the traffic meter not to block Internet access when the traffic limit is reached, you can resume Internet access. If your ISP sets a usage limit, they might charge you for the overage.
- Your computer might not recognize any DNS server addresses. A DNS server is a host on the Internet that translates Internet names (such as www addresses) to numeric IP addresses.
Typically, your ISP provides the addresses of one or two DNS servers for your use. If you entered a DNS address during the router's configuration, restart your computer.
Alternatively, you can configure your computer manually with a DNS address, as explained in the documentation for your computer.
- The router might not be configured as the default gateway on your computer.
Reboot the computer and verify that the router address (www.routerlogin.net) is listed by your computer as the default gateway address.
- You might be running login software that is no longer needed. If your ISP provided a program to log you in to the Internet (such as WinPoET), you no longer need to run that software after installing your router. You might need to go to Internet Explorer and select **Tools > Internet Options**, click the **Connections** tab, and select the **Never dial a connection**. Other browsers provide similar options.

Changes Are Not Saved

If the router does not save the changes that you make on the router web pages, do the following:

- When entering configuration settings, always click the **Apply** button before moving to another page or tab, or your changes are lost.
- Click the **Refresh** or **Reload** button in the web browser. It is possible that the changes occurred, but the old settings might be in the web browser's cache.

Troubleshoot WiFi Connectivity

If you are experiencing trouble connecting over WiFi to the router, try to isolate the problem:

- Does the WiFi device or computer that you are using find your WiFi network?
If not, check the WiFi LED on the front of the router. If it is off, you can press the **WiFi On/Off** button on the router to turn the router WiFi radios back on.
If you disabled the router's SSID broadcast, then your WiFi network is hidden and does not display in your WiFi client's scanning list. (By default, SSID broadcast is enabled.)
- Does your WiFi device support the security that you are using for your WiFi network (WPA or WPA2)?
- If you want to view the WiFi settings for the router, use an Ethernet cable to connect a computer to a LAN port on the router. Then log in to the router, and select **BASIC > Wireless**.

Note Be sure to click the **Apply** button if you change settings.

If your WiFi device finds your network but the signal strength is weak, check these conditions:

- Is your router too far from your computer or too close? Place your computer near the router but at least 6 feet (1.8 meters) away and see whether the signal strength improves.
- Are objects between the router and your computer blocking the WiFi signal?

Troubleshoot Your Network Using the Ping Utility

Most network devices and routers contain a ping utility that sends an echo request packet to the designated device. The device then responds with an echo reply. You can easily troubleshoot a network using the ping utility in your computer or workstation.

Test the LAN Path to Your Router

You can ping the router from your computer to verify that the LAN path to your router is set up correctly.

► To ping the router from a Windows computer:

1. From the Windows toolbar, click the **Start** button and select **Run**.
2. In the field provided, type **ping** followed by the IP address of the router, as in this example:
ping www.routerlogin.net
3. Click the **OK** button.

You see a message like this one:

```
Pinging <IP address > with 32 bytes of data
```

If the path is working, you see this message:

```
Reply from < IP address >: bytes=32 time=NN ms TTL=xxx
```

If the path is not working, you see this message:

```
Request timed out
```

If the path is not functioning correctly, one of the following problems might be occurring:

- **Wrong physical connections**
For a wired connection, make sure that the numbered LAN port LED is lit for the port to which you are connected. Check to see that the appropriate LEDs are lit for your network devices. If your router and computer are connected to a separate Ethernet switch, make sure that the link LEDs are lit for the switch ports that are connected to your computer and router.
- **Wrong network configuration**
Verify that the Ethernet card driver software and TCP/IP software are both installed and configured on your computer.
Verify that the IP address for your router and your computer are correct and that the addresses are on the same subnet.

Test the Path From Your Computer to a Remote Device

► To test the path from your computer to a remote device:

1. From the Windows toolbar, click the **Start** button and select **Run**.
2. In the Windows Run window, type

```
ping -n 10 <IP address>
```

where *<IP address>* is the IP address of a remote device such as your ISP DNS server.

If the path is functioning correctly, messages display that are similar to those shown in [Test the LAN Path to Your Router](#) on page 179.

3. If you do not receive replies, check the following:
 - Check to see that IP address of your router is listed as the default gateway for your computer. If DHCP assigns the IP configuration of your computers, this information is not visible in your computer Network Control Panel. Verify that the IP address of the router is listed as the default gateway.
 - Check to see that the network address of your computer (the portion of the IP address specified by the subnet mask) is different from the network address of the remote device.
 - Check to see that your cable or DSL modem is connected and functioning.
 - If your ISP assigned a host name to your computer, enter that host name as the account name on the Internet Setup page.
 - Your ISP might be rejecting the Ethernet MAC addresses of all but one of your computers.

Nighthawk X4S AC2600 Smart WiFi Router

Many broadband ISPs restrict access by allowing traffic only from the MAC address of your broadband modem. Some ISPs additionally restrict access to the MAC address of a single computer connected to that modem. If your ISP does this, configure your router to “clone” or “spoof” the MAC address from the authorized computer.

This appendix includes technical information about your router.

The appendix covers the following topics:

- *Factory Settings* on page 183
- *Technical Specifications* on page 184

Factory Settings

You can return the router to its factory settings. Use the end of a paper clip or a similar object to press and hold the **Reset** button on the back of the router for at least seven seconds. The router resets and returns to the factory configuration settings shown in the following table.

Table 3. Factory default settings

Feature		Default Setting
Router login	User login URL	www.routerlogin.com or www.routerlogin.net
	User name (case-sensitive)	admin
	Login password (case-sensitive)	password
Internet connection	WAN MAC address	Use default hardware address
	WAN MTU size	1500
	Port speed	AutoSensing
Local network (LAN)	LAN IP	192.168.1.1
	Subnet mask	255.255.255.0
	DHCP server	Enabled
	DHCP range	192.168.1.2 to 192.168.1.254
	Time zone	Pacific time
	DHCP starting IP address	192.168.1.2
	DHCP ending IP address	192.168.1.254
	DMZ	Disabled
	Time adjusted for daylight saving time	Disabled
	SNMP	Disabled
Firewall	Inbound (communications coming in from the Internet)	Disabled (except traffic on port 80, the HTTP port)
	Outbound (communications going out to the Internet)	Enabled (all)
	Source MAC filtering	Disabled

Nighthawk X4S AC2600 Smart WiFi Router

Feature		Default Setting
Wireless	Wireless communication	Enabled
	SSID name	See router label
	Security	WPA2-PSK (AES)
	Broadcast SSID	Enabled
	Transmission speed	Auto ¹
	Country/region	United States in the US; otherwise, varies by region
	RF channel	Auto for 2.4GHz, CH 44 for WW SKU and CH 153 for North America SKU
	Operating mode	Up to 600 Mbps at 2.4 GHz, 1733 Mbps at 5 GHz

¹Maximum wireless signal rate derived from IEEE Standard 802.11 specifications. Actual throughput can vary. Network conditions and environmental factors, including volume of network traffic, building materials and construction, and network overhead, lower actual data throughput rate.

Technical Specifications

Table 4. R7800 router specifications

Feature	Description
Data and routing protocols	TCP/IP, RIP-1, RIP-2, DHCP, PPPoE, PPTP, Bigpond, Dynamic DNS, UPnP, and SMB
Power adapter	<ul style="list-style-type: none"> • North America: 100-240V, 50/60 Hz input • UK, Australia: 100-240V, 50/60 Hz, input • Europe: 100-240V, 50/60 Hz input • All regions (output): 12V/3.5A DC output
Dimensions	11.22 x 7.26 x 1.97 in. (285 x 184.5 x 50 mm)
Weight	1.65 lb (750 g)
Operating temperature	0° to 40°C (32° to 104°F)
Operating humidity	90% maximum relative humidity, noncondensing

Nighthawk X4S AC2600 Smart WiFi Router

Feature	Description
Electromagnetic emissions	FCC Part 15 Class B EN 55 022 (CISPR 22), Class B C-Tick N10947
LAN	10BASE-T or 100BASE-TX or 1000BASE-T, RJ-45
WAN	10BASE-T or 100BASE-TX or 1000BASE-T, RJ-45
Wireless	Maximum WiFi signal rate complies with the IEEE 802.11 standard. ²
Radio data rates	Auto Rate Sensing
Data encoding standards	<ul style="list-style-type: none"> • IEEE® 802.11 b/g/n 2.4 GHz–256 QAM support • IEEE® 802.11 a/n/ac 5.0 GHz
Maximum computers per WiFi network	Limited by the amount of WiFi network traffic generated by each node (typically 50–70 nodes).
Operating frequency range	AC2600 WiFi ³ <ul style="list-style-type: none"> • 800 Mbps @2.4GHz–256 QAM • 1733 Mbps @5 GHz 11ac
802.11 security	WPA2-PSK and WPA/WPA2

²Maximum wireless signal rate derived from IEEE Standard 802.11 specifications. Actual throughput can vary. Network conditions and environmental factors, including volume of network traffic, building materials and construction, and network overhead, lower actual data throughput rate.

³NETGEAR makes no express or implied representations or warranties about this product's compatibility with any future standards. 802.11ac 1733 Mbps is approximately 4x faster than 802.11n 450 Mbps. 2.4 GHz Performance Mode requires 256 QAM support on the WiFi client. Up to 1733 Mbps wireless speeds achieved when connecting to other 802.11ac 1733 Mbps devices.