

JBL

®

JBL LS SERIES

LS40, LS60, LS80,
LS CENTER

OWNER'S GUIDE



JBL® LS SERIES

For more than 60 years, JBL, Inc. has been providing audio equipment for concert halls, recording studios and movie theaters around the world and has become the hands-down choice of leading recording artists and sound engineers.

With the JBL LS Series, innovative technologies such as pure-titanium compression drivers, Elliptical Oblate Spheroidal™ (EOS) waveguides and Bi-Radial Horn® are available to you. Enjoy!

UNPACKING THE SPEAKERS

If you suspect damage from transit, report it immediately to your dealer. Keep the shipping carton and packing materials for future use.

INCLUDED

LS60, LS80

Spike kit (packed in end pads)



(4) coasters

PLACEMENT

NEVER drag the speaker to move it, as this will damage the spikes, the feet and/or the wood cabinet itself. Always lift the speaker and carry it to its new location.

CAUTION: Floorstanding (tower) loudspeakers have a high center of gravity and may become unstable and tip over during events such as earthquakes, or if rocked, tipped or improperly positioned. If this is a concern, these speakers should be anchored to the wall behind them, using the same procedures and hardware customary for anchoring bookcases and wall units. The customer is responsible for proper installation and proper selection of hardware.

STEREO

Before deciding where to place your speakers, survey your room and think about placement, keeping the following points in mind, using Figure 1 as a guide:

- For best results, place the speakers 6'-8' (1.5m-2.5m) apart.
- Position each speaker so that the tweeter is approximately at ear level.
- Generally, bass output will increase as the speaker is moved closer to a wall or corner.
- Refer to "Home Theater" below if you also plan to use the speakers for home theater reproduction.

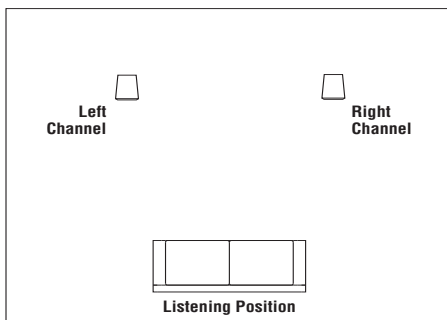

Figure 1. Experiment with speaker placement to obtain the best bass level and stereo imaging in your room.

HOME THEATER

For front-channel use, place one speaker on the left and another on the right, along either side of the television monitor. The JBL LS speakers are primarily designed for use with Plasma, LCD and DLP TV screens, and should not be placed in close proximity of CRT (Cathode Ray Tube) TV sets.

For surround-channel use, place speakers on bookshelves or stands alongside the listening position. Final placement depends on room acoustics, availability of space and your listening preference (Figures 2 and 3).

In 6- or 7-channel configurations, place the rear channel(s) behind the listening position, as shown in Figures 2 and 3.

NOTE: A JBL powered subwoofer will add impact and realism to both music and film soundtracks. Contact your JBL dealer for recommendations on subwoofer models for your application.

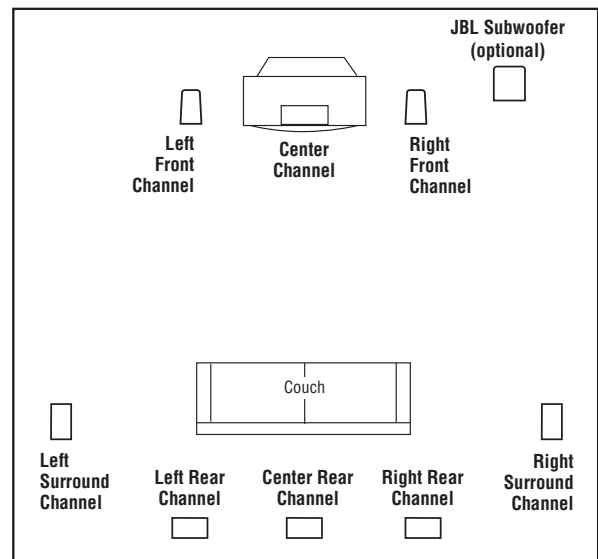

Figure 2. This overhead view shows a typical home theater plan. Left/right rear channels are for a 7-channel system. The center rear channel is for a 6-channel system.

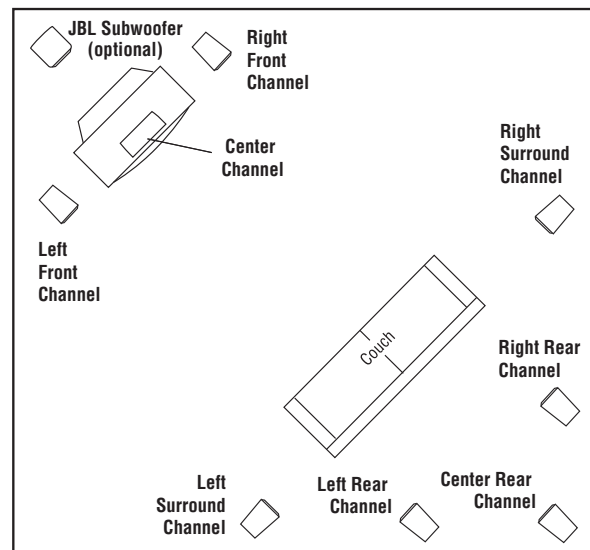

Figure 3. This figure shows an alternate layout, which may be more suitable for some rooms. Left/right rear channels are for a 7-channel system. The center rear channel is for a 6-channel system.

INSTALLING SPIKED FEET

LS60, LS80

Four metal spikes are supplied for use when the speaker is to be placed on a carpeted surface; using them decouples the speaker from the floor to prevent unwanted damping. To insert the spikes, gently lay the speaker on its side (not its front or back) on a soft, nonabrasive surface, and unscrew the rubber-tipped feet (store in a safe place). Each spike then screws into the threaded insert in each corner. Make sure all four spikes are screwed in completely for stability. To protect the surface of uncarpeted floors, set each spike into an included metal coaster.

NEVER drag the speaker to move it, as this will damage the spikes, the feet the wood cabinet itself and/or the floor. **ALWAYS** lift the speaker and carry it to its new location.

WIRING THE SYSTEM

IMPORTANT: MAKE SURE ALL EQUIPMENT IS TURNED OFF BEFORE MAKING ANY CONNECTIONS

For speaker connections, use a high-quality speaker wire with polarity coding. The side of the wire with a ridge or other coding is usually considered positive polarity (i.e., +).

NOTE: If desired, consult your local JBL dealer about speaker wire and connection options.

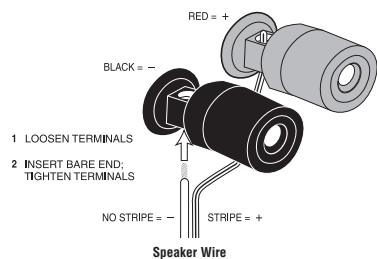

Figure 4. This figure shows how to connect bare wires to the terminals.

The speakers have coded terminals that accept a variety of wire connectors. The most common connection is shown in Figure 4.

To ensure proper polarity, connect each + terminal on the back of the amplifier or receiver to the respective + (red) terminal on each speaker, as shown in Figure 5. Connect the - (black) terminals in a similar way. See the owner's guides that were included with your amplifier, receiver and television to confirm connection procedures.

IMPORTANT: DO NOT REVERSE POLARITIES (I.E., + TO - OR - TO +) WHEN MAKING CONNECTIONS. DOING SO WILL CAUSE POOR IMAGING AND DIMINISHED BASS RESPONSE.

STANDARD CONNECTION

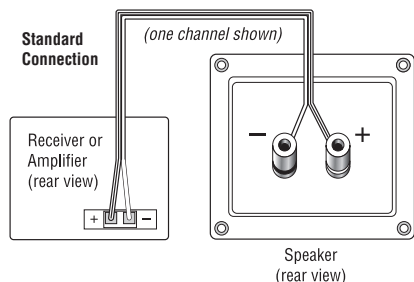
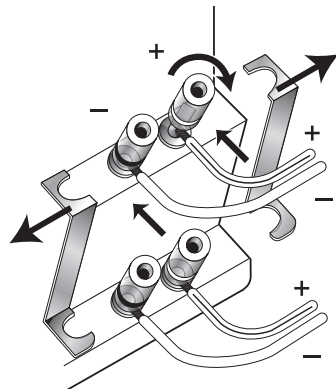

Figure 5. Wiring diagram shows polarity connections for one channel of a stereo or home theater system.

BI-WIRING

LS40, LS60, LS80

The outer connection panel and internal dividing network of the LS40, LS60 and LS80 are designed so that separate sets of speaker cables can be attached to the low-frequency transducer and midrange/high-frequency transducer portions of this dividing network. This is called bi-wiring. Bi-wiring can provide several sonic advantages and considerably more flexibility in power amplifier selection.



1. Loosen the terminals and remove strapping bars.
2. Insert the speaker wire for the high frequencies into the top set of terminals and tighten.
3. Insert the speaker wire for the low frequencies into the bottom set of terminals and tighten.

Figure 6.

SINGLE-STEREO AMPLIFIER

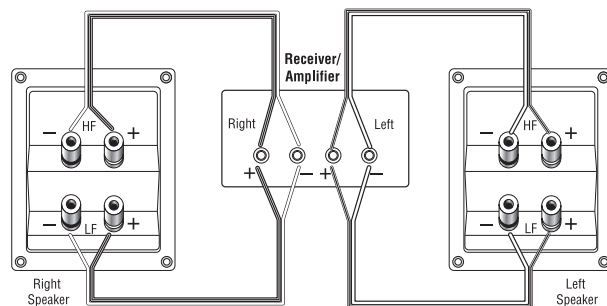

Figure 7.

DUAL-STEREO AMPLIFIER

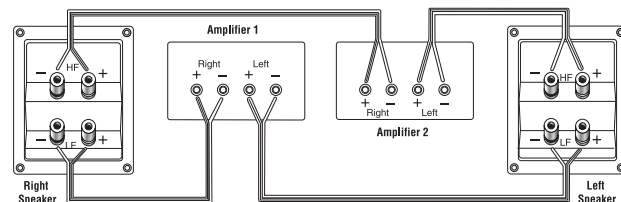

Figure 8.

FINAL ADJUSTMENTS

Check the speakers for playback, first by setting the system volume control to a minimum level, and then by applying power to your audio system. Play a favorite music or video segment and increase the system volume control to a comfortable level.

NOTE: You should hear balanced audio reproduction across the entire frequency spectrum. If not, check all wiring connections or consult the authorized JBL dealer from whom you purchased the system for more help.

The amount of bass you hear and the stereo-image quality will be affected by a number of different factors, including the room's size and shape, the construction materials used to build the room, the listener's position relative to the speakers, and the position of the speakers in the room.

Listen to a variety of music selections and note the bass level. If there is too much bass, move the speakers away from nearby walls. Conversely, if you place the speakers closer to the walls, there will be more bass output.

CARE OF YOUR SPEAKER SYSTEM

Each JBL LS Series enclosure has a finish that does not require any routine maintenance. When needed, use a soft cloth to remove any fingerprints or dust from the enclosure or grille.

NOTE: Do not use any cleaning products or polishes on the cabinet or grille.

SPECIFICATIONS

	LS40	LS60	LS80
Frequency Response (-10dB)	42Hz – 40kHz	40Hz – 40kHz	35Hz – 40kHz
Frequency Response (-3dB)	50Hz – 38kHz	48Hz – 38kHz	46Hz – 38kHz
Power Handling (Continuous)	75W	75W	100W
Power Handling (Music)	150W	150W	200W
Power Handling (Peak)	300W	300W	400W
Max. Rec. Amplifier Power*	150W	150W	200W
Sensitivity (2.83V/1m)	87dB	87dB	90dB
Crossover Frequency	2.6kHz, 7kHz; 24dB/octave	400Hz, 6dB/octave,† 2kHz, 8kHz; 24dB/octave	400Hz, 6dB/octave,† 2.5kHz, 8kHz; 24dB/octave
Nominal Impedance	6 Ohms	6 Ohms	6 Ohms
Low-Frequency Transducer(s)	6-1/2" (165mm) with cast-aluminum frames	Dual 6-1/2" (165mm) with cast-aluminum frames	Dual 8" (200mm) with cast-aluminum frames
High-Frequency Transducer	2" (50mm) Pure-titanium compression driver, Bi-Radial Horn®.	2" (50mm) Pure-titanium compression driver, Bi-Radial Horn®.	2" (50mm) Pure-titanium compression driver, Bi-Radial Horn®.
Ultrahigh-Frequency Transducer	3/4" (19mm) Polyester-film ring-radiator, neodymium magnet; EOS waveguide	3/4" (19mm) Polyester-film ring-radiator, neodymium magnet; EOS waveguide	3/4" (19mm) Polyester-film ring-radiator, neodymium magnet; EOS waveguide
Dimensions (H x W x D)	19-7/16" x 8-3/4" x 13-1/2" (493mm x 222mm x 343mm)	39-1/2" x 8-3/4" x 13-1/2" (1004mm x 222mm x 343mm)	43-1/2" x 10-3/16" x 16-1/2" (1104mm x 259mm x 418mm)
Dimensions (H x W x D) (with feet and pad)	19-5/8" x 8-3/4" x 13-1/2" (499mm x 222mm x 343mm)	40" x 8-3/4" x 13-1/2" (1017mm x 222mm x 343mm)	44" x 10-3/16" x 16-1/2" (1117mm x 259mm x 418mm)
Weight per Speaker (net weight)	29.8 lb (13.5kg)	58.6 lb (26.6kg)	78.5 lb (35.6kg)

LS CENTER

Frequency Response (-10dB)	50Hz – 40kHz
Frequency Response (-3dB)	85Hz – 38kHz
Power Handling (Continuous)	75W
Power Handling (Music)	150W
Power Handling (Peak)	300W
Max. Rec. Amplifier Power*	150W
Sensitivity (2.83V/1m)	88dB
Crossover Frequency	2.5kHz, 9kHz; 24dB/octave
Nominal Impedance	6 Ohms
Low-Frequency Transducers	Dual 6-1/2" (165mm) with cast-aluminum frames
High-Frequency Transducer	2" (50mm) Pure-titanium compression driver, Bi-Radial Horn®.
Ultrahigh-Frequency Transducer	3/4" (19mm) Polyester-film ring-radiator, neodymium magnet; EOS waveguide
Dimensions (H x W x D)	8-1/2" x 26-1/2" x 9-1/4" (217mm x 672mm x 235mm)
Dimensions (H x W x D) (with feet and pad)	9" x 26-1/2" x 9-1/4" (230mm x 672mm x 235mm)
Weight per Speaker (net weight)	31.7 lb (14.4kg)

* The maximum recommended amplifier power rating will ensure proper system headroom to allow for occasional peaks. We do not recommend sustained operation at these maximum power levels.

† High-pass crossover for one of the two low-frequency transducers only.

Declaration of Conformity



We, Harman Consumer Group, Inc.
2, route de Tours
72500 Château du Loir
France

declare in own responsibility that the products described
in this owner's manual are in compliance with technical
standards:

EN 61000-6-3:2001

EN 61000-6-1:2001

Laurent Rault
Harman Consumer Group, Inc.
Château du Loir, France 01/08

Features, specifications and appearance are subject to change without notice.

JBL is a trademark of Harman International Industries, Incorporated, registered in the United States and/or other countries. Elliptical Oblate Spheroidal and Pro Sound Comes Home are trademarks of Harman International Industries, Incorporated.

JBL **PRO SOUND COMES HOME™**

Harman Consumer Group, Inc., 250 Crossways Park Drive, Woodbury, NY 11797 USA
8500 Balboa Boulevard, Northridge, CA 91329 USA
2, route de Tours, 72500 Château du Loir, France
www.jbl.com

© 2008 Harman International Industries, Incorporated. All rights reserved.
Part No. 406-000-05776-E

H A Harman International® Company