

B

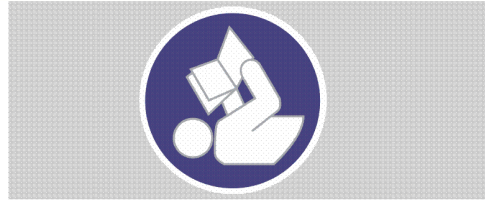

60 min

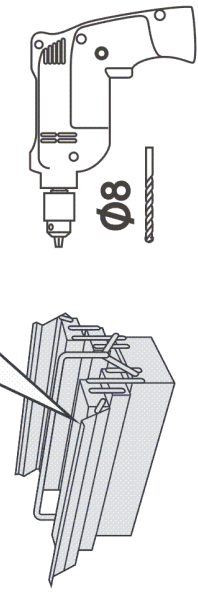

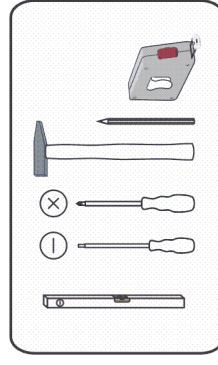
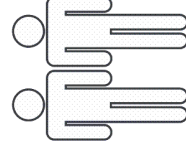
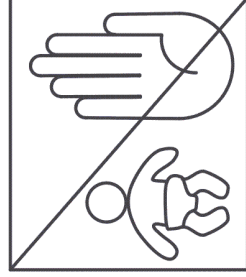
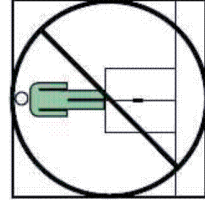
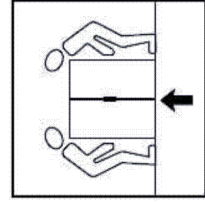
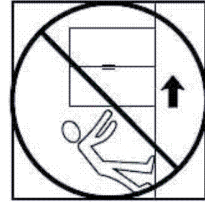
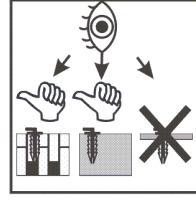
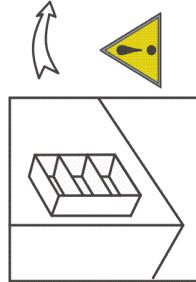
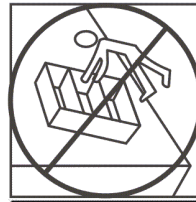
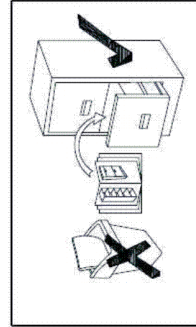
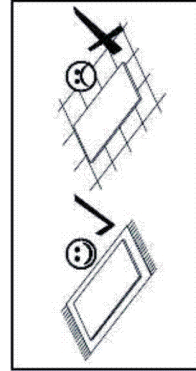
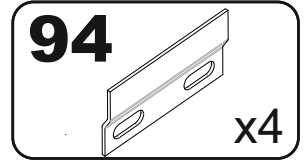
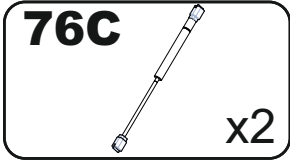
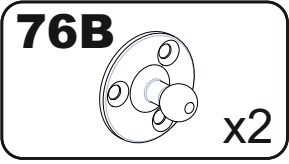
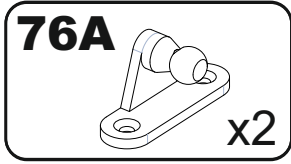
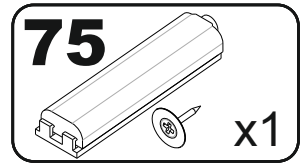
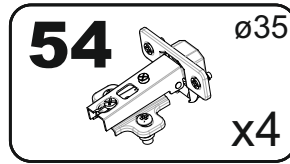
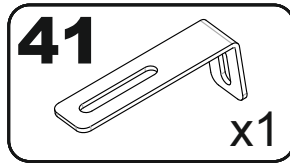
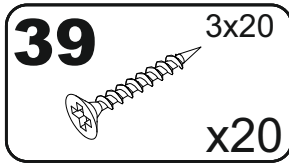
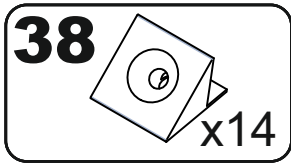
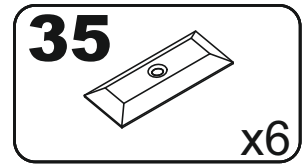
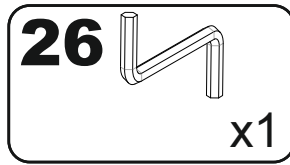
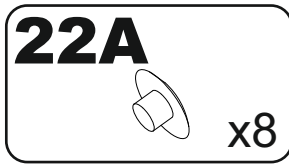
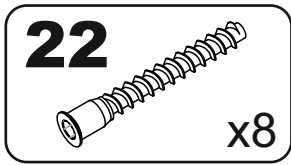
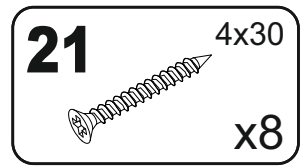
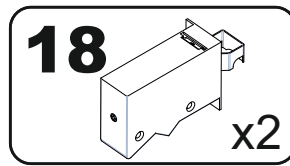
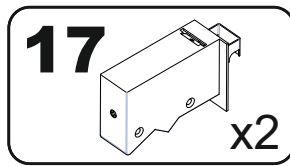
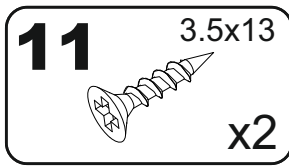
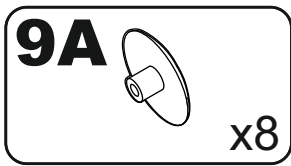
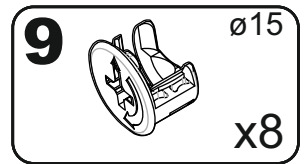
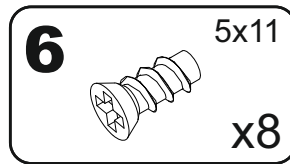
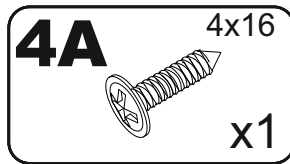
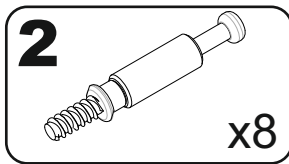
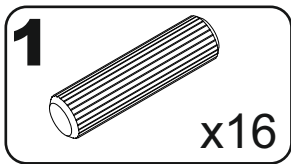
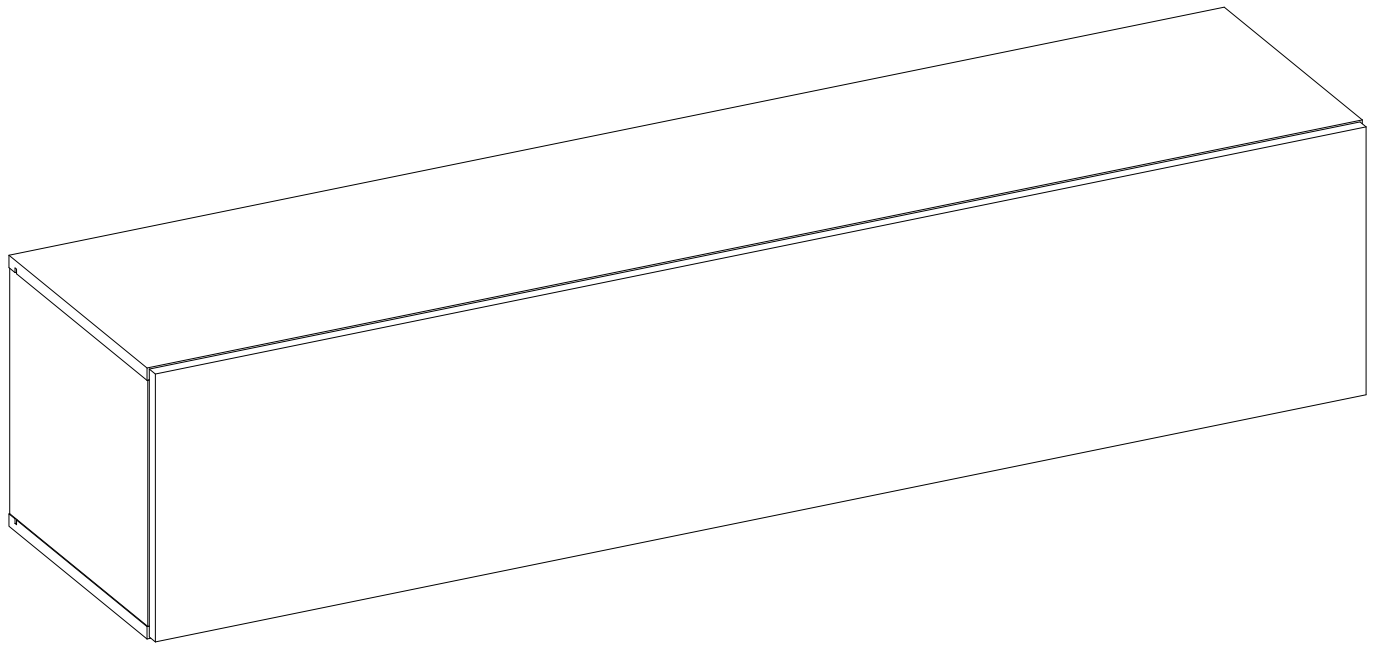
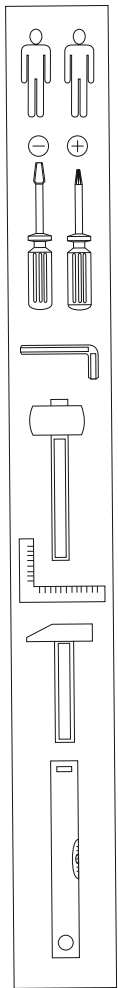

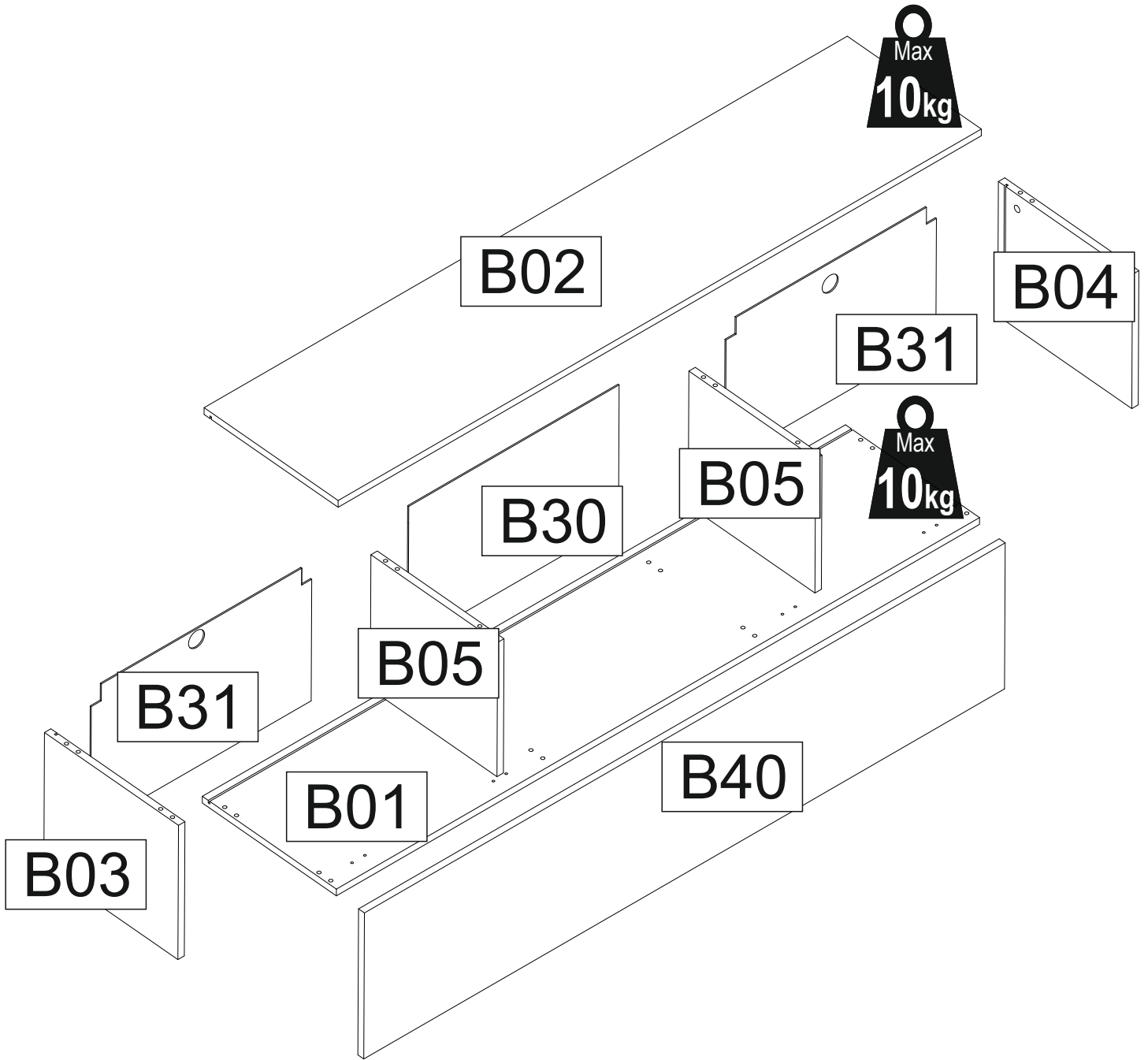

A	B (mm)	C (mm)	D (mm)	E	F
B01	1502	364	16	1	1 1
B02	1502	364	16	1	1 1
B03	318	364	16	1	1 1
B04	318	364	16	1	1 1
B05	318	344	16	2	1 1
B30	491	328	3	1	1 1
B31	491	328	3	2	1 1
B40	1496	346	16	1	1 1

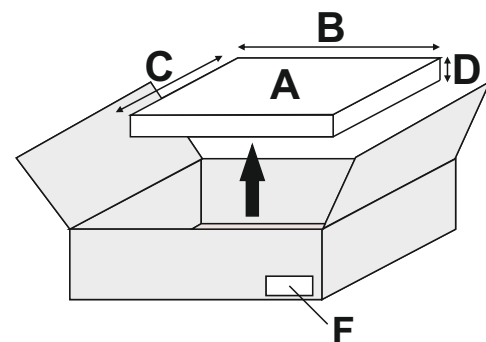
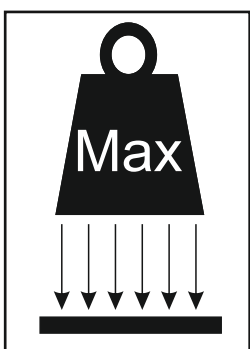

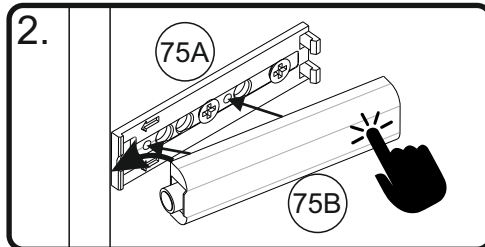
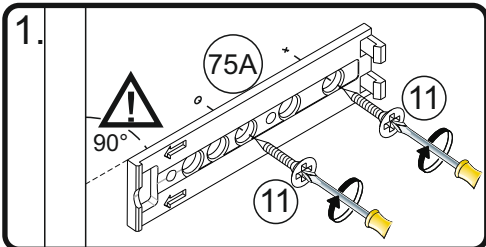
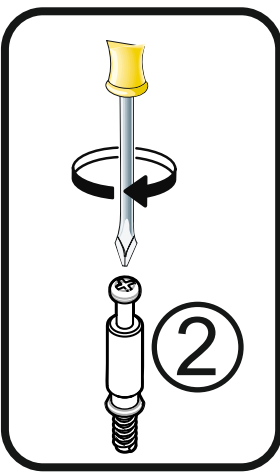
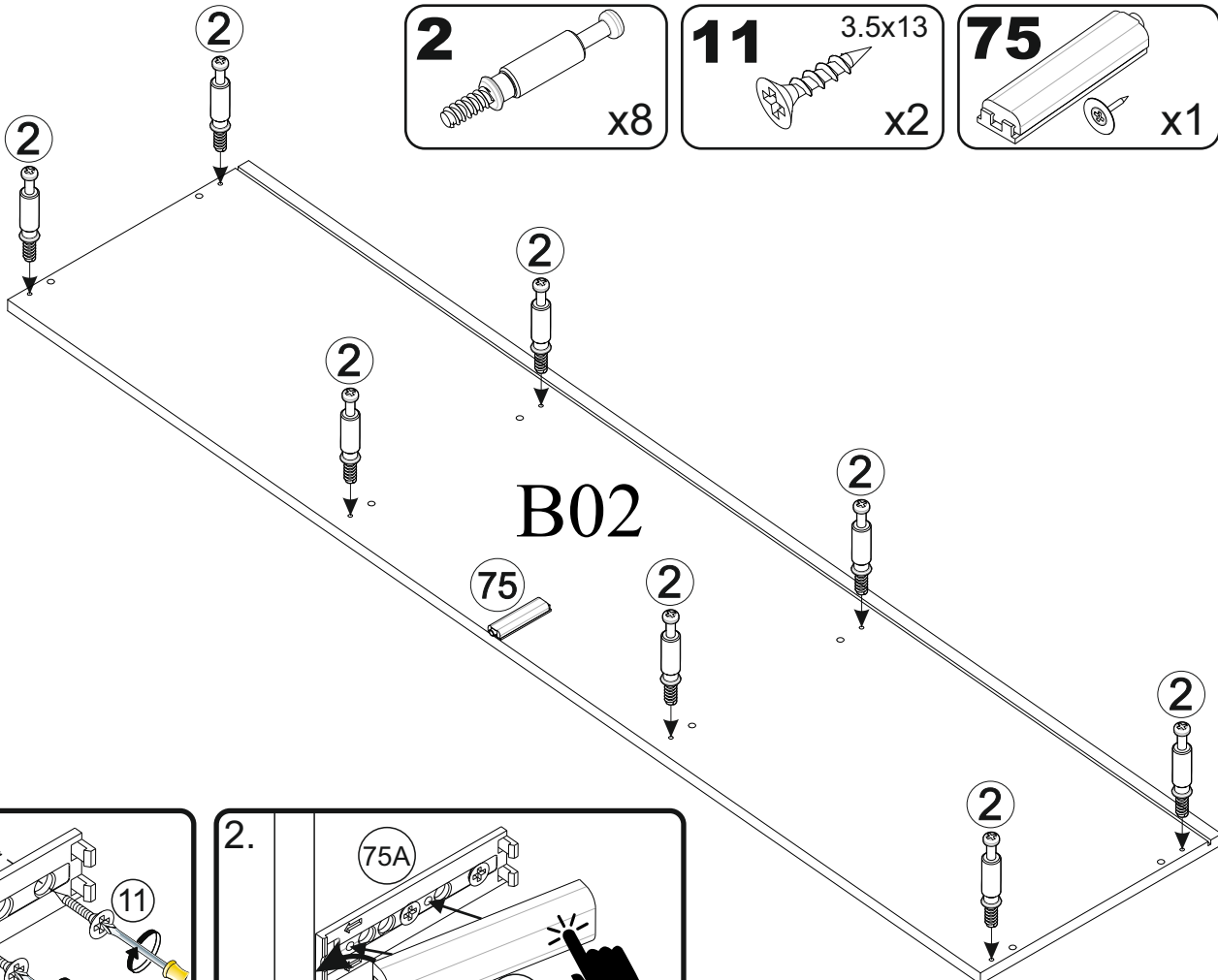
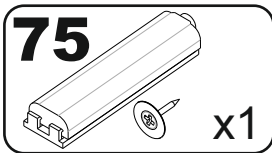
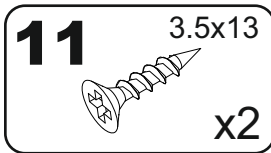
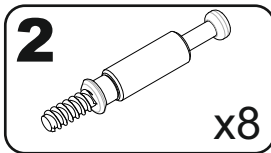

1

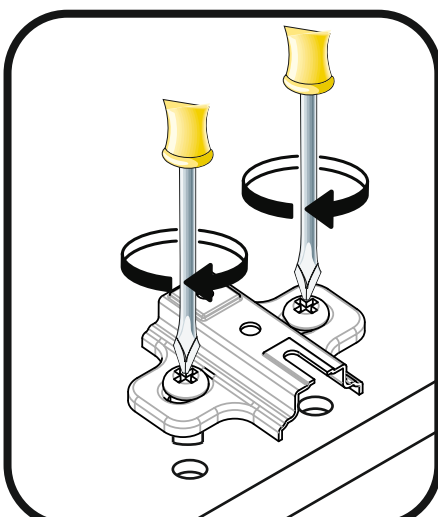
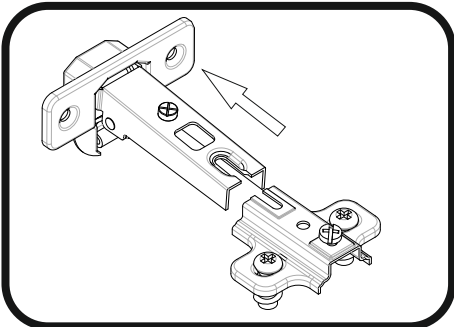
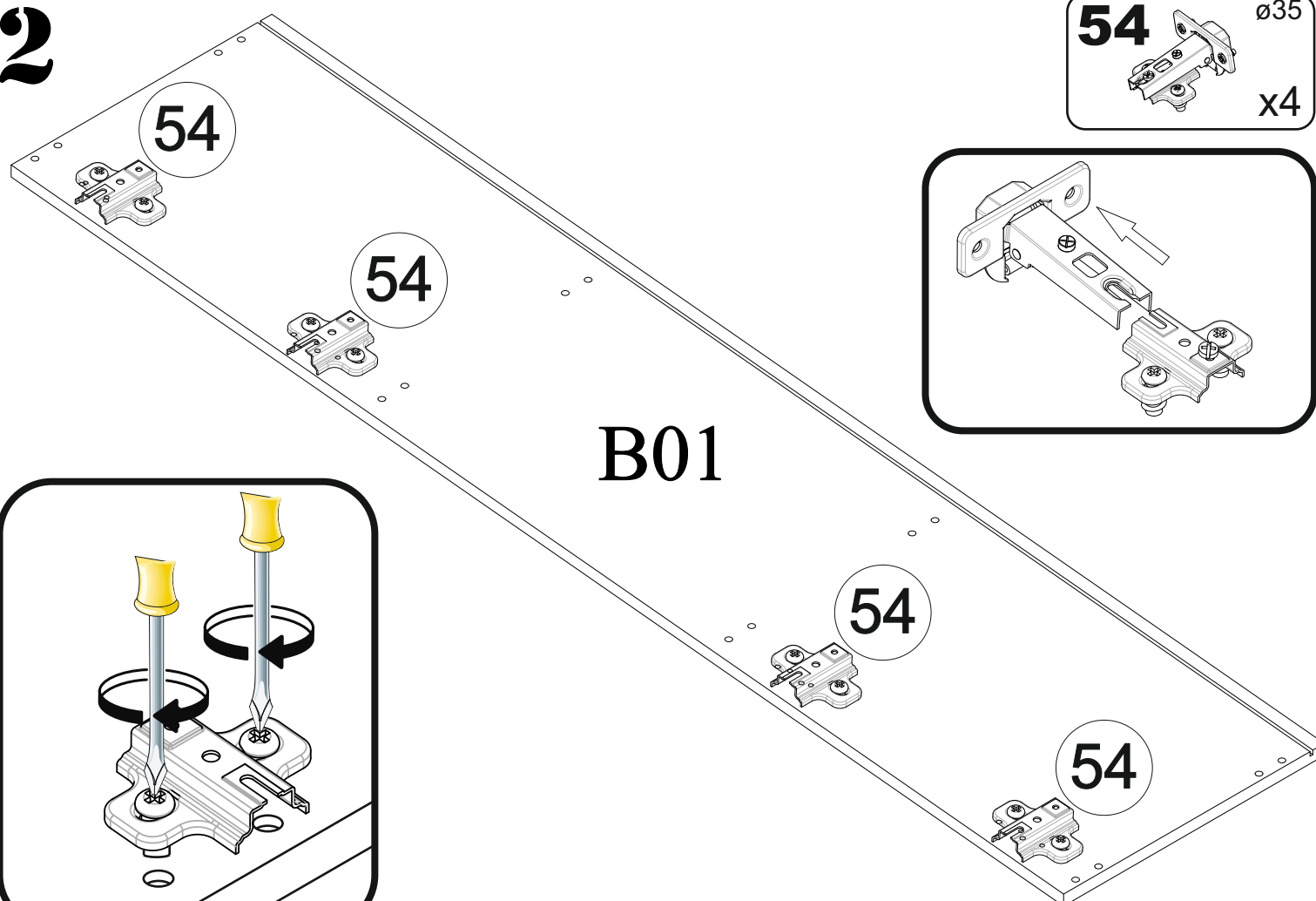
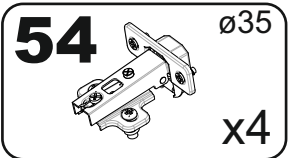

2



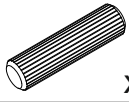

5

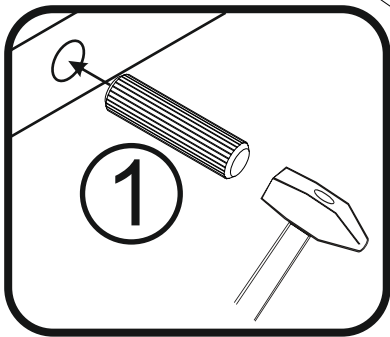
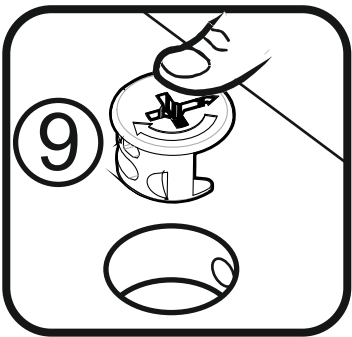
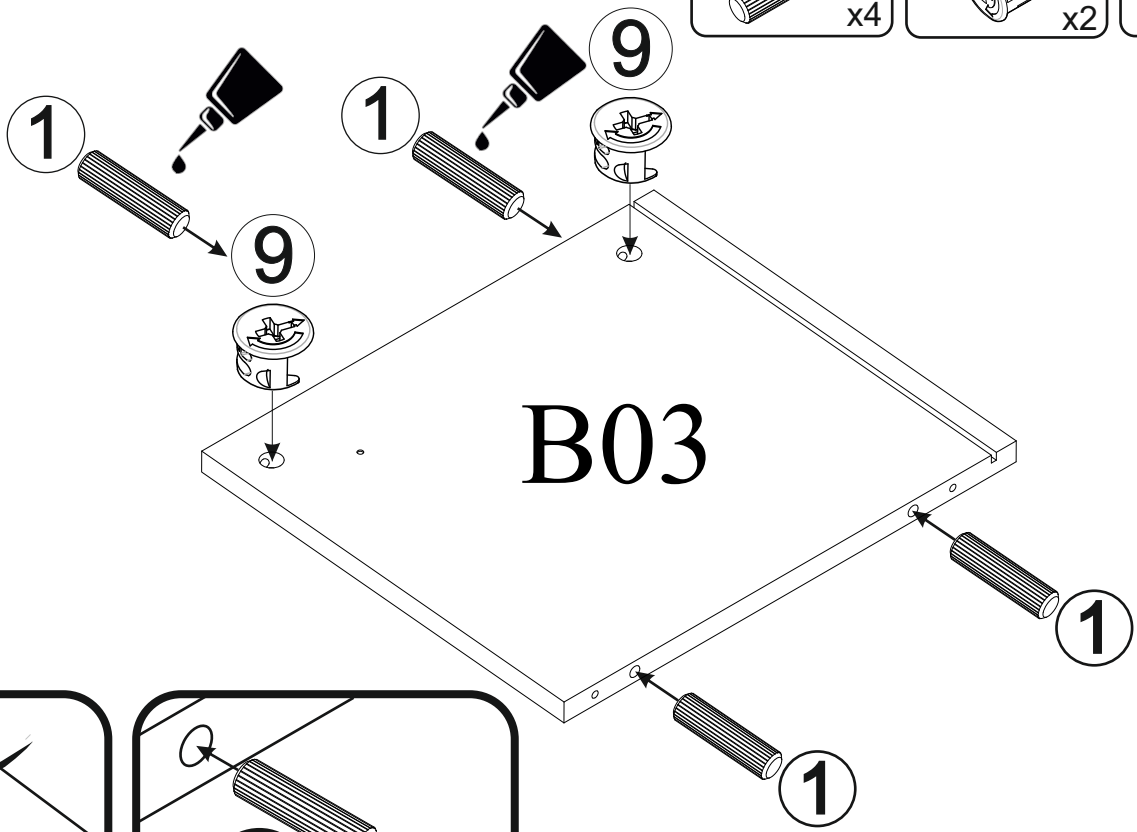
- 1  x4
- 9  ø15 x2
- 32  x1

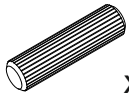

6

- 1  x4
- 9  ø15 x2
- 32  x1

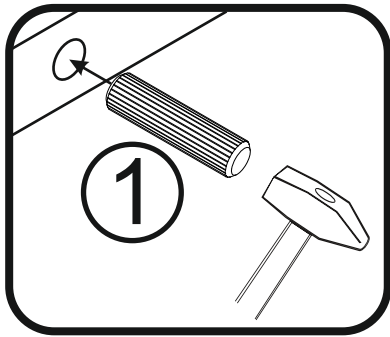
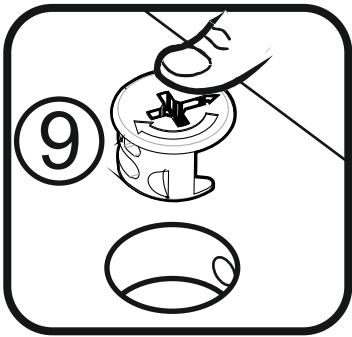
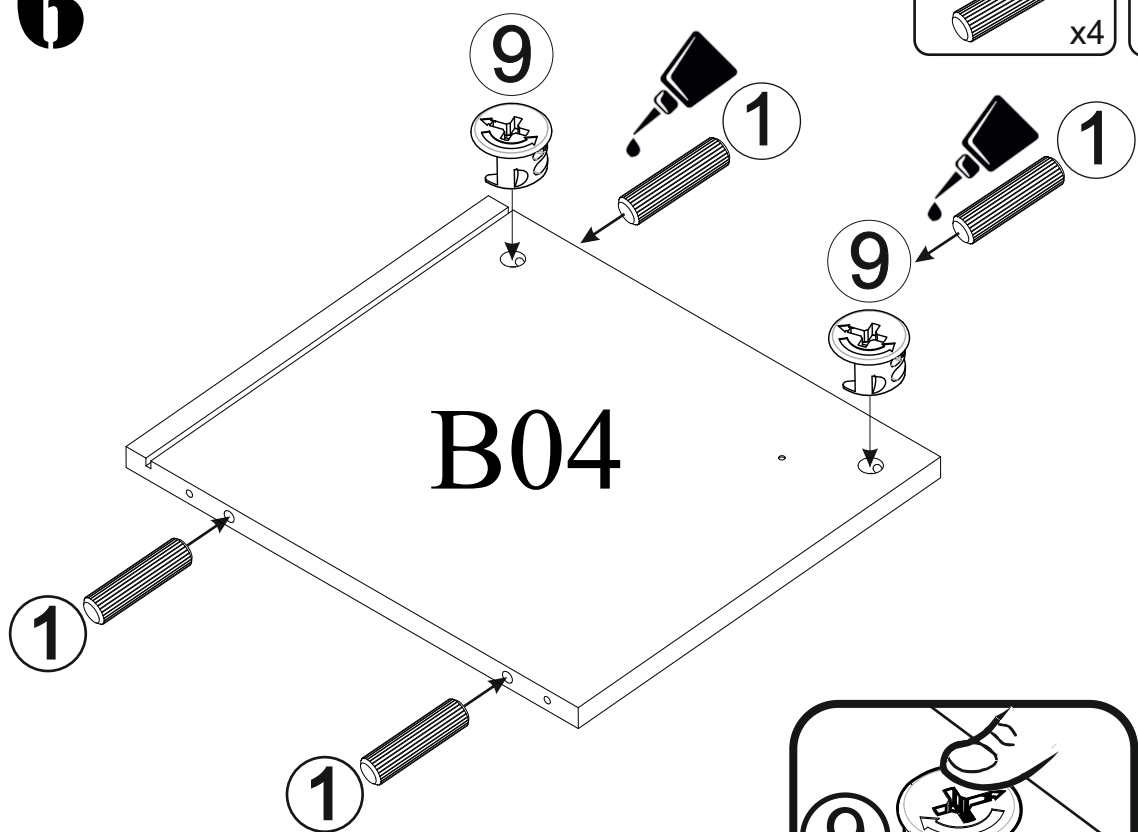

7

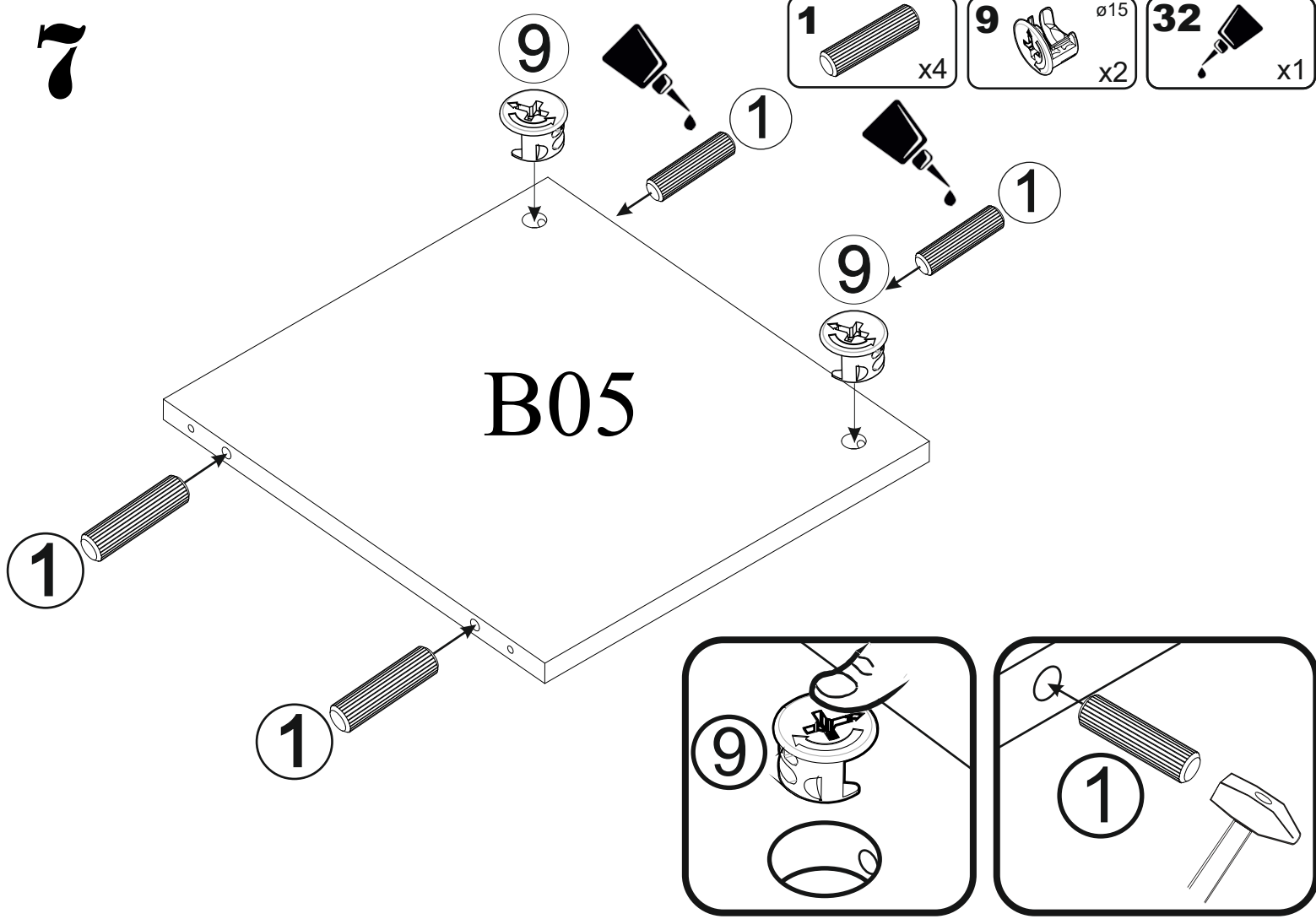

8

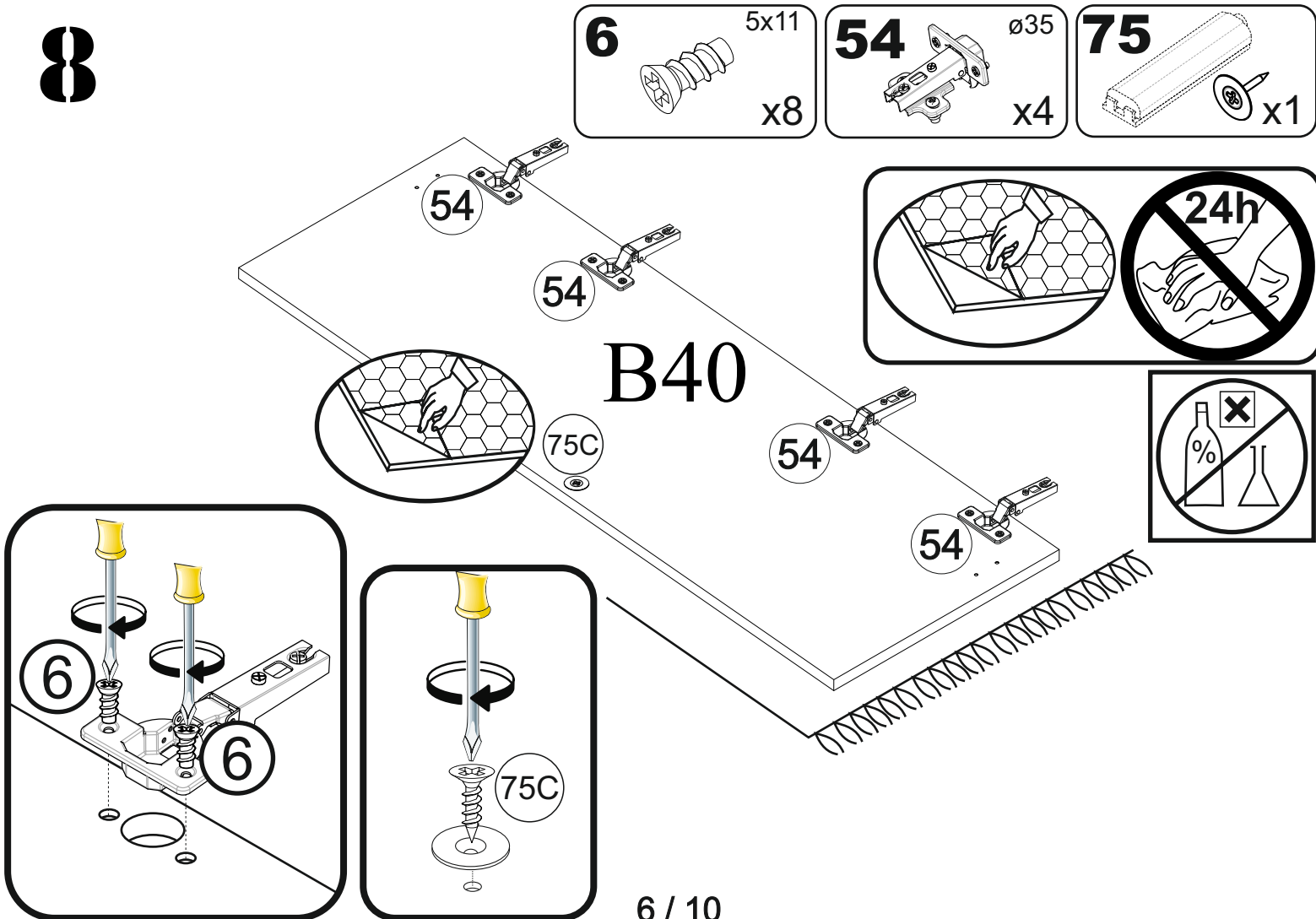

9

9A  x8

32  x1

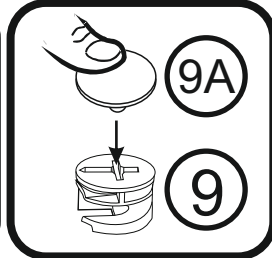
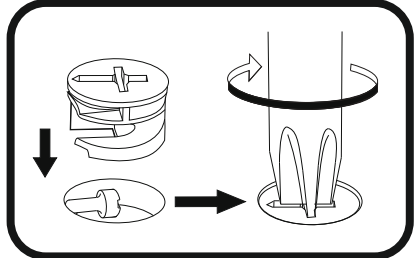
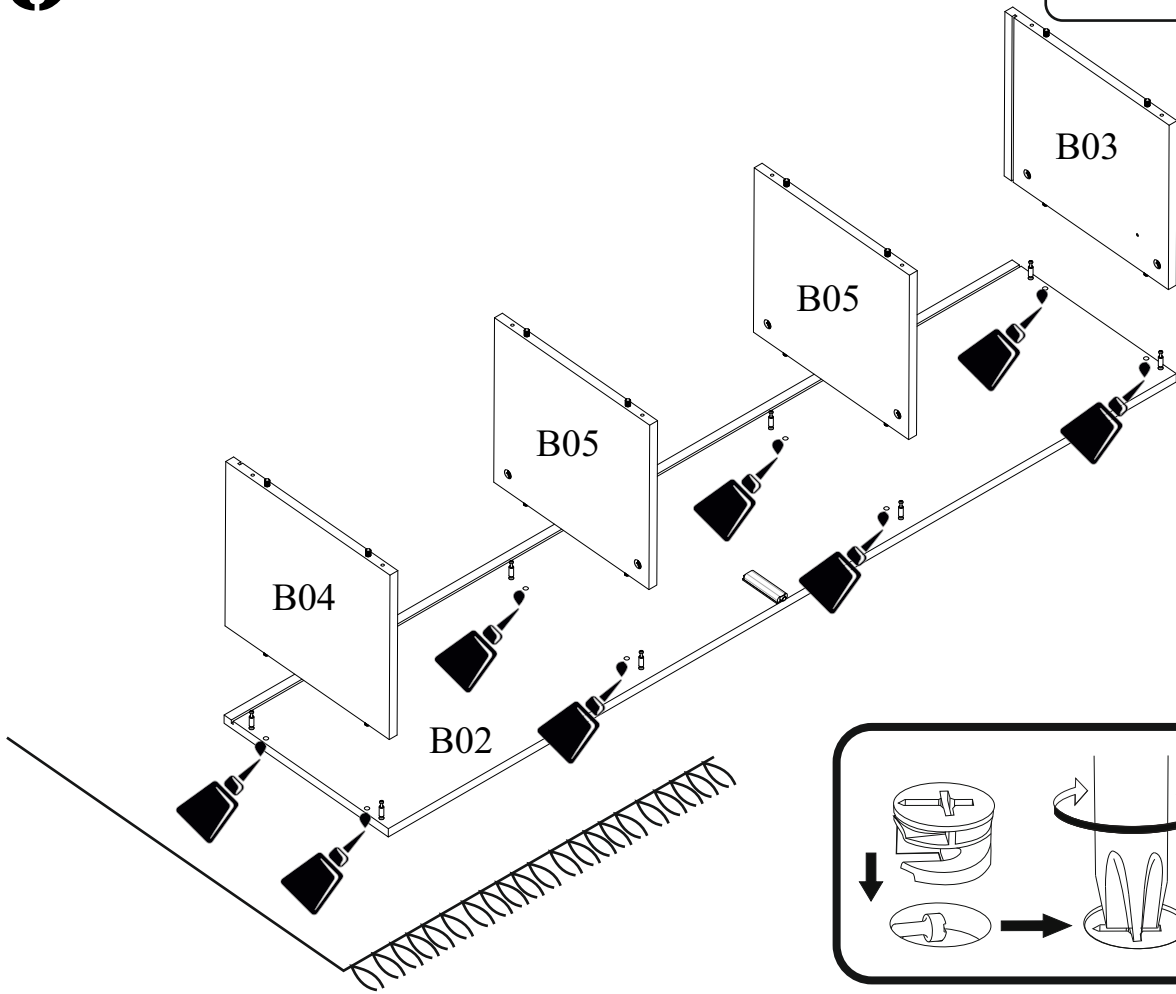

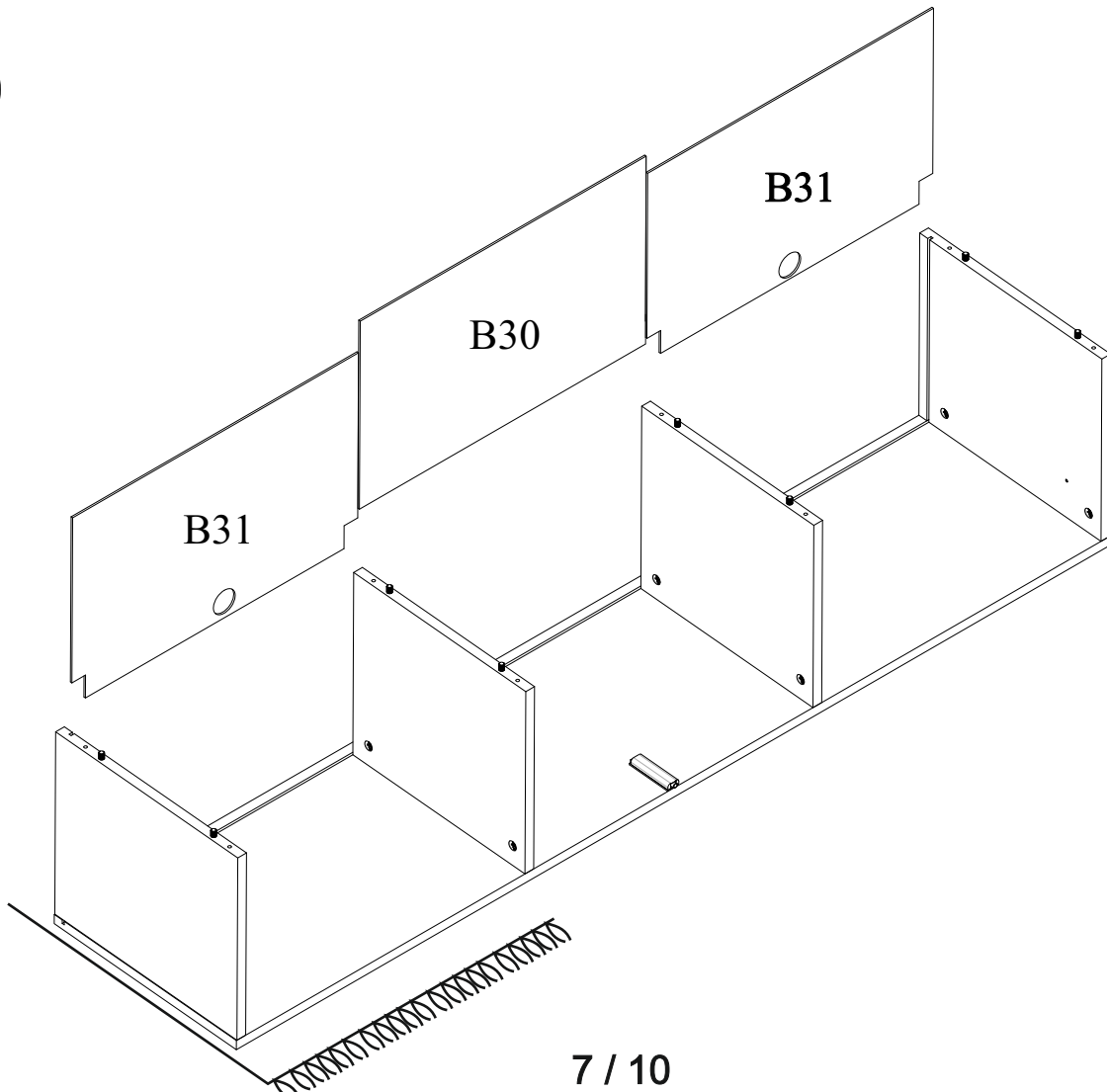

10



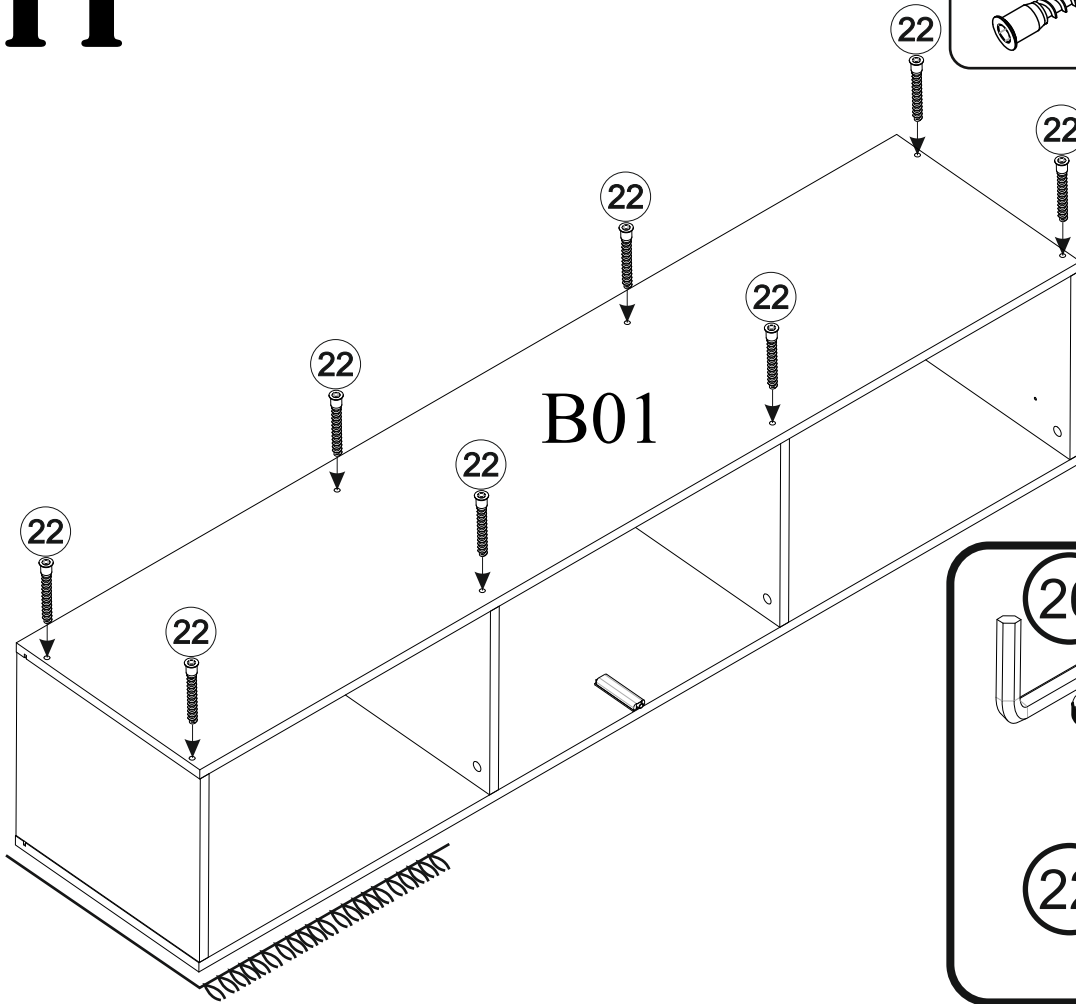

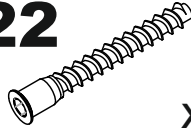

11

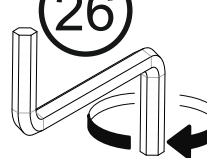

22  x8

22A  x8

26  

22A  

12

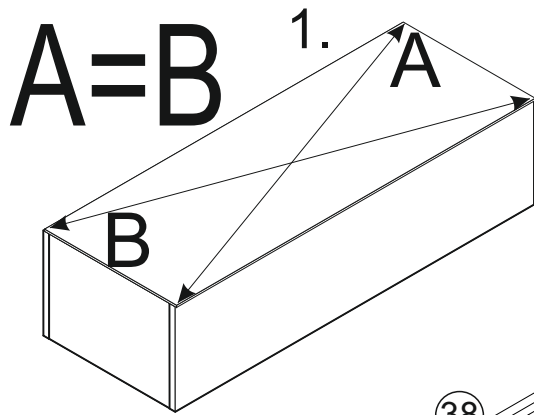

35  x6

38  x14

39  3x20 x20

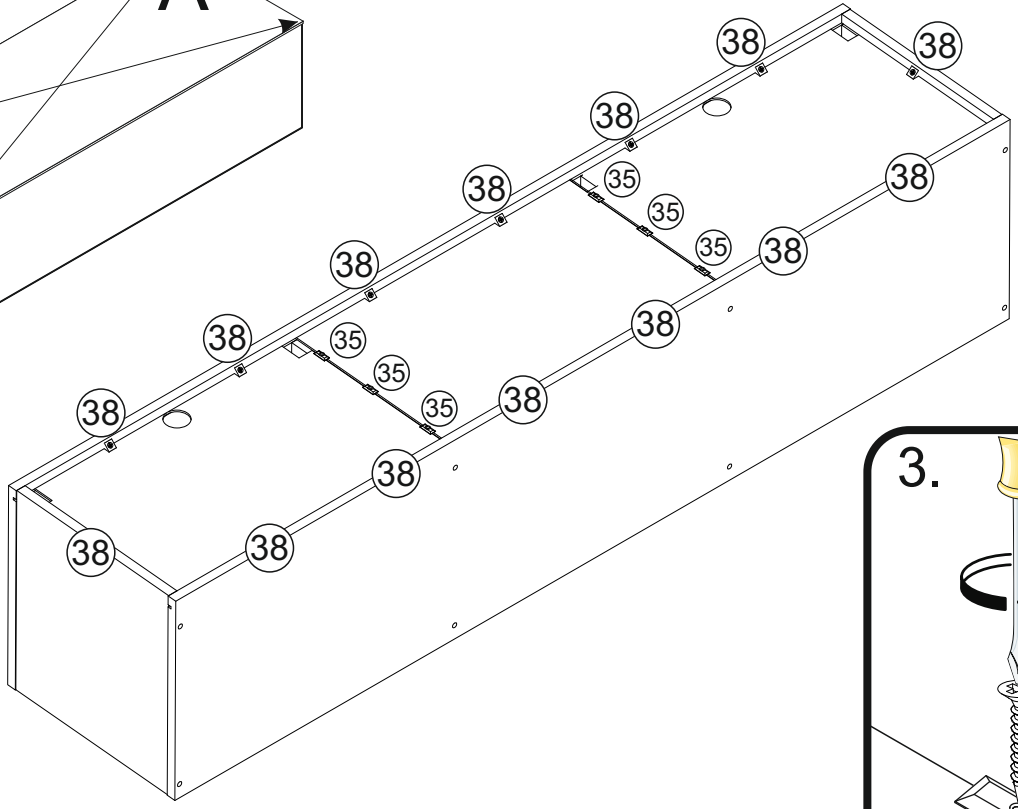

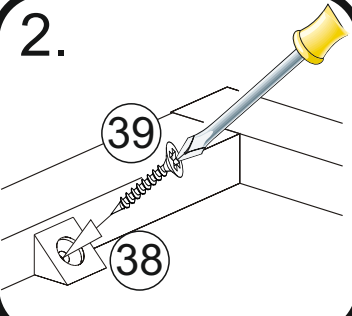
2. 

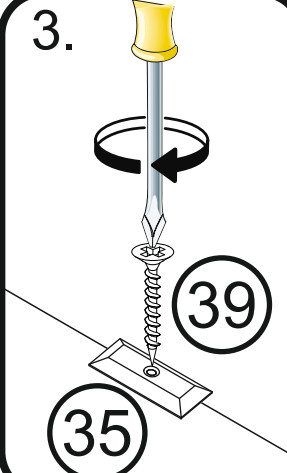
3. 

13

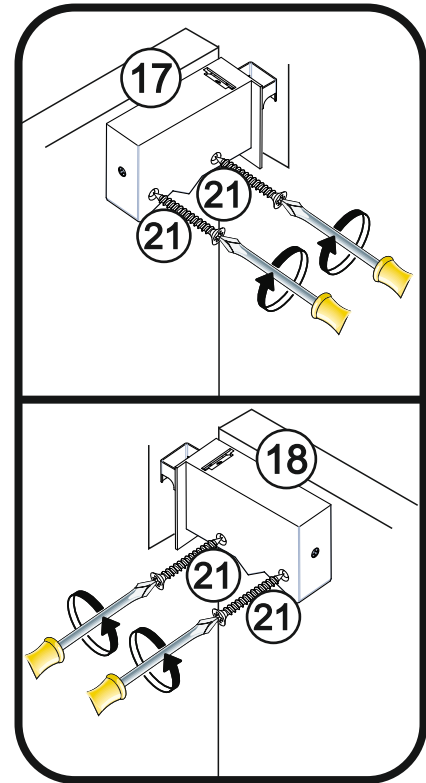
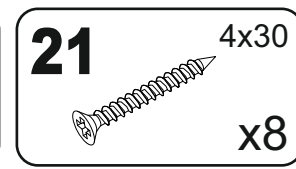
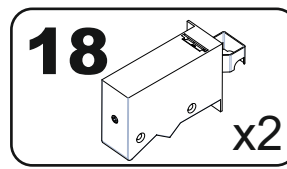
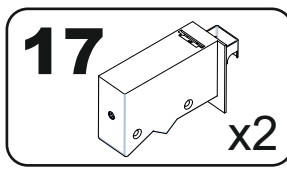
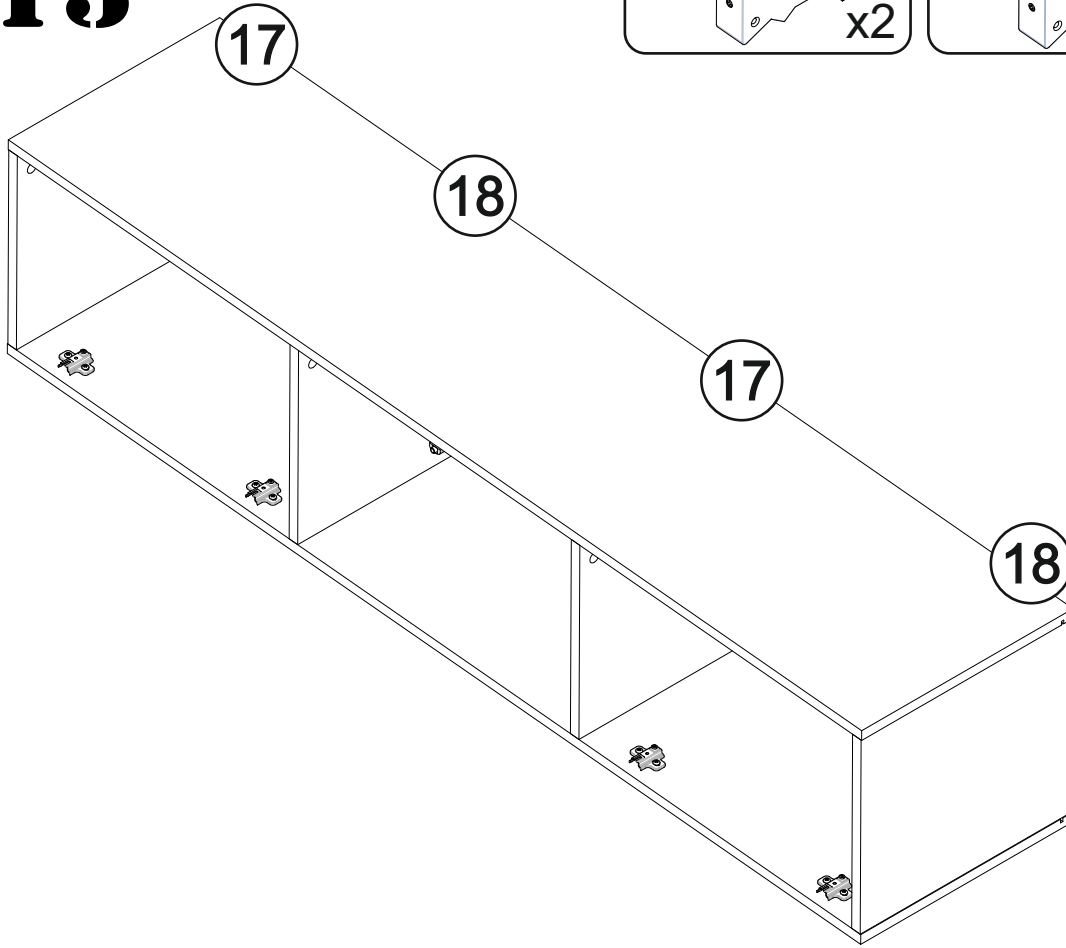

14

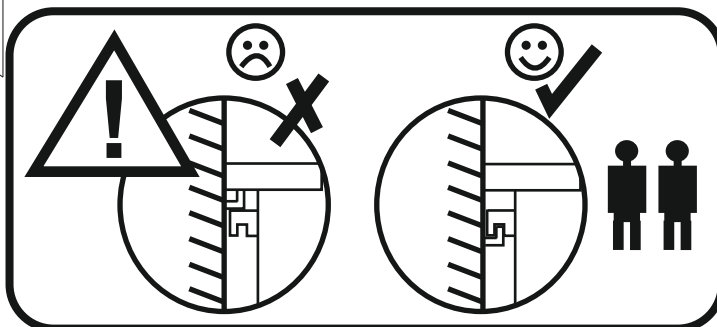
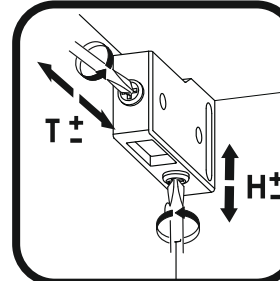
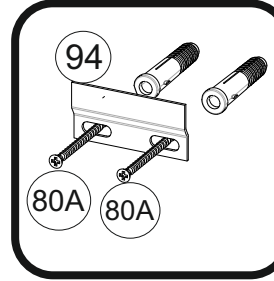
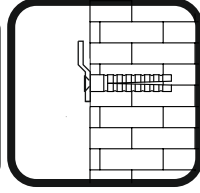
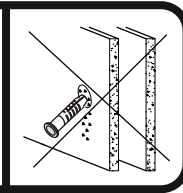
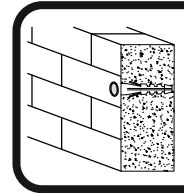
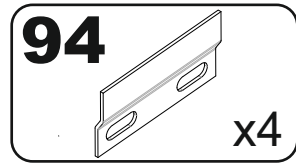
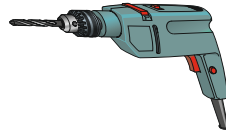
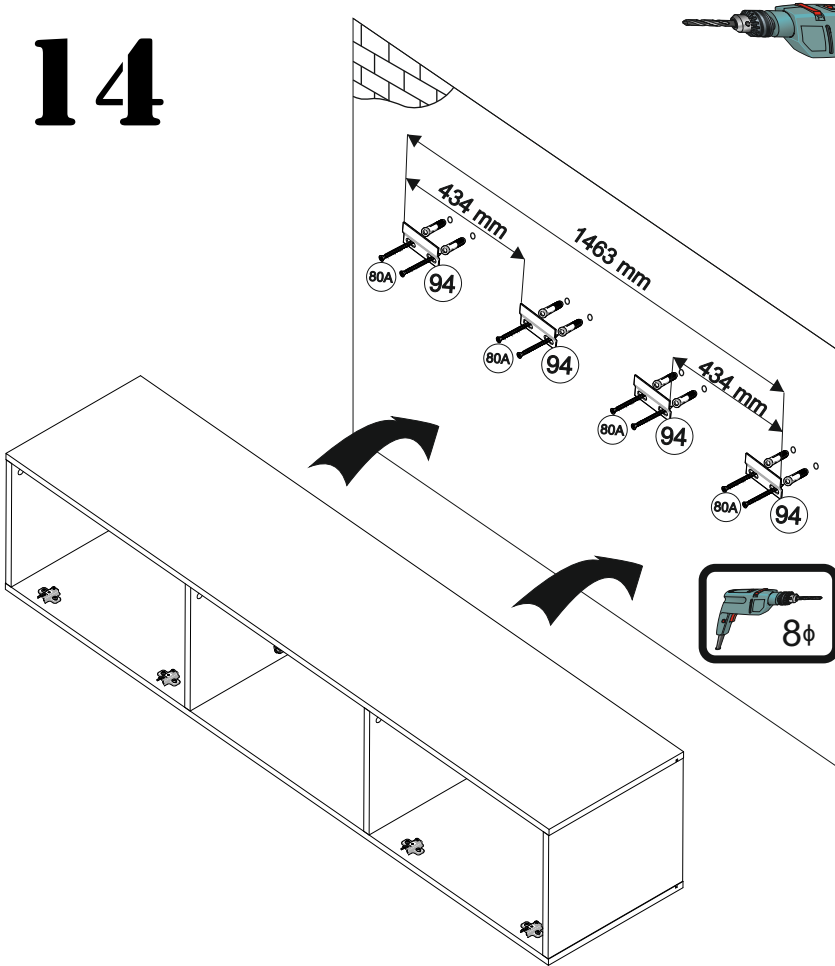

15

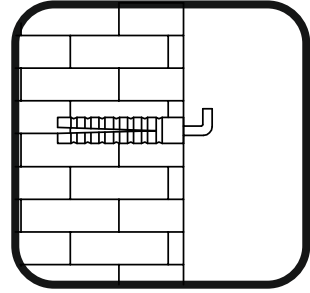
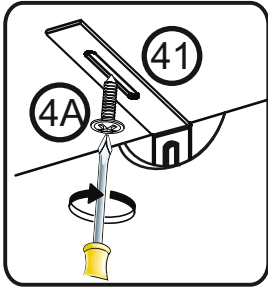
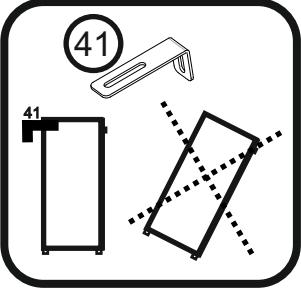
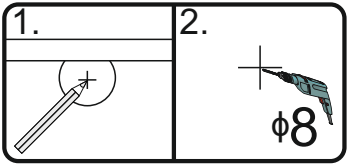
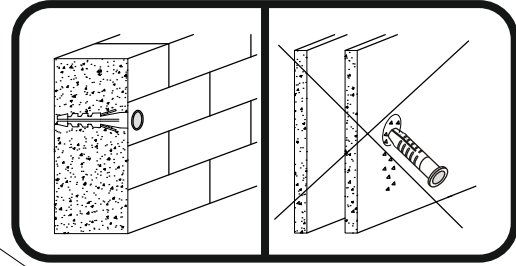
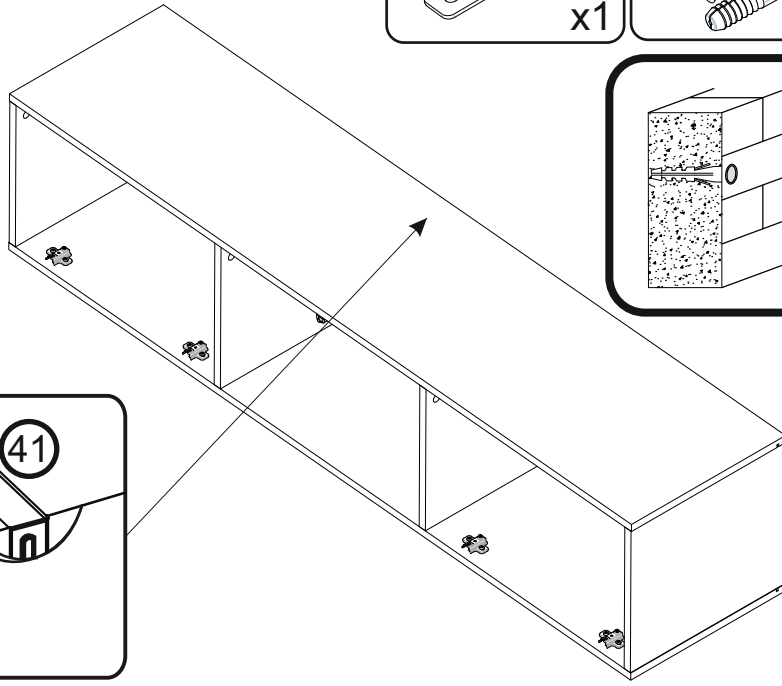
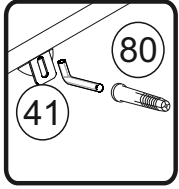
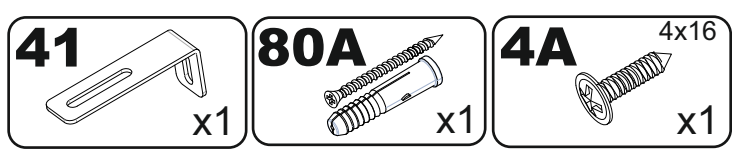

16

