



1/5

A	B	C	D	E
				
x 1	x 1	x 5	x 5	x 5



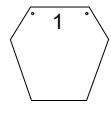
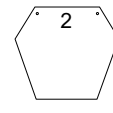
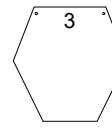
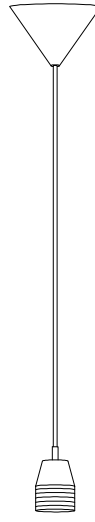

A

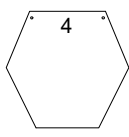
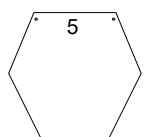
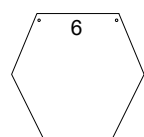
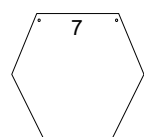
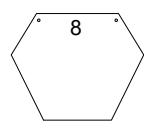
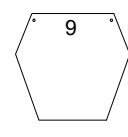
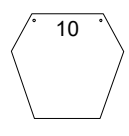
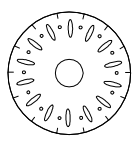
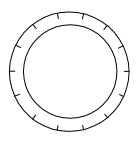
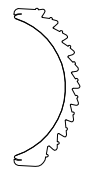
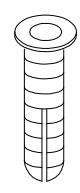
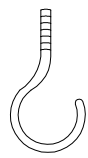

B

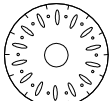
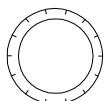

F	G	H	I	J	K
					
x 5	x 5	x 5	x 5	x 5	x 5
L	M	N	O	P	Q
					
x 5	x 1	x 1	x 10	x 1	x 1

1

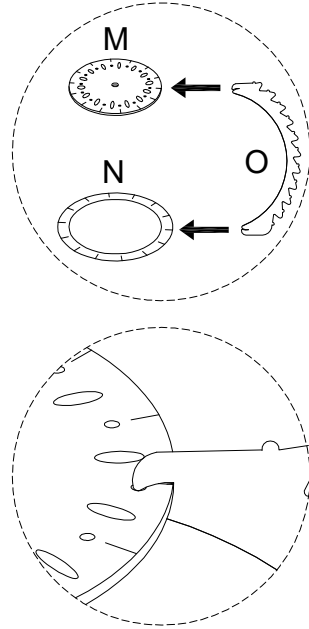
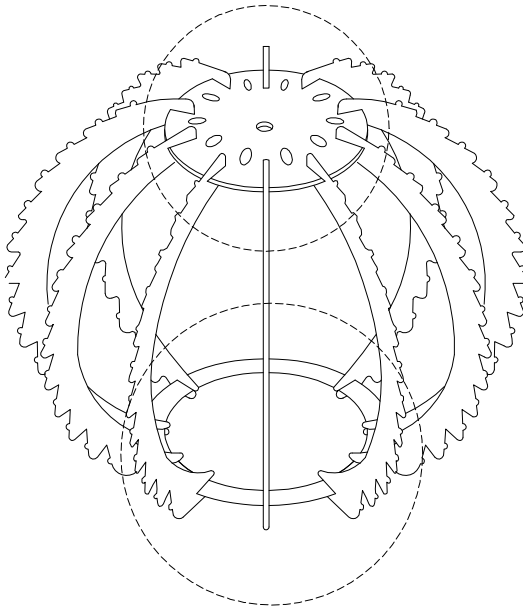
M  x 1	N  x 1	O  x 10
--	--	---

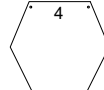
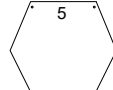
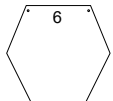
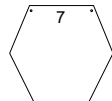
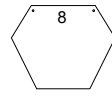
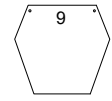
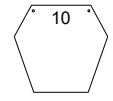

2

C  x 5	D  x 5	E  x 5	F  x 5	G  x 5
H  x 5	I  x 5	J  x 5	K  x 5	L  x 5

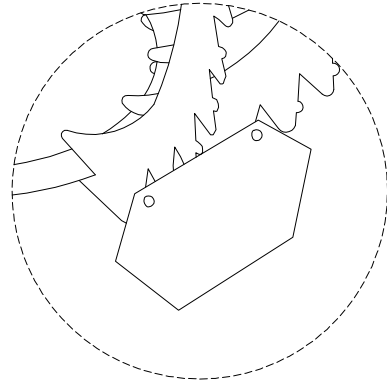
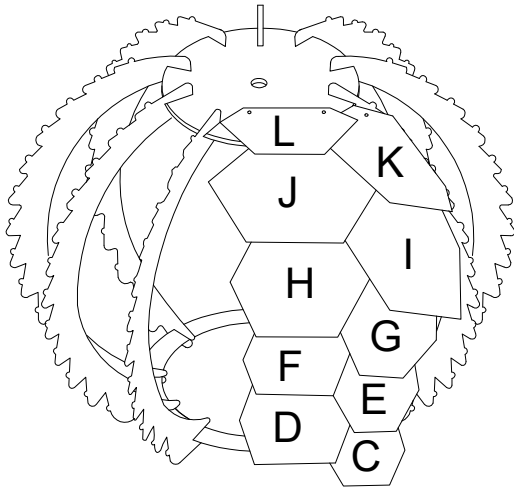

3

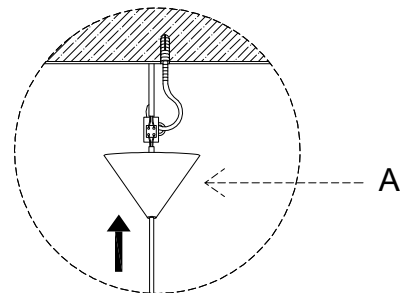
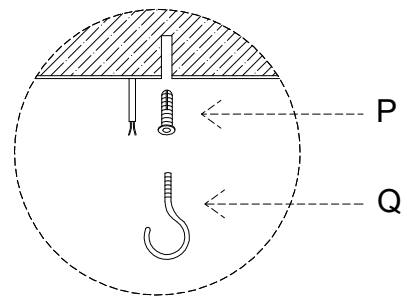
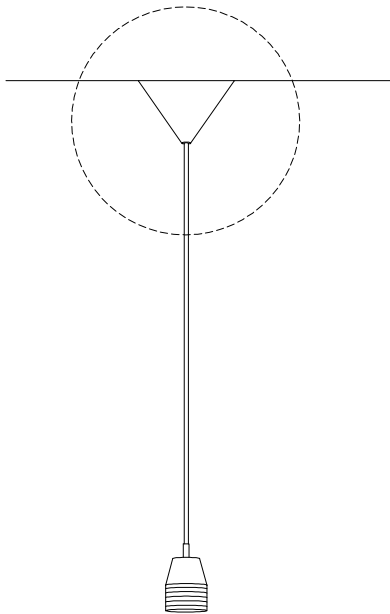
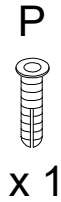

4

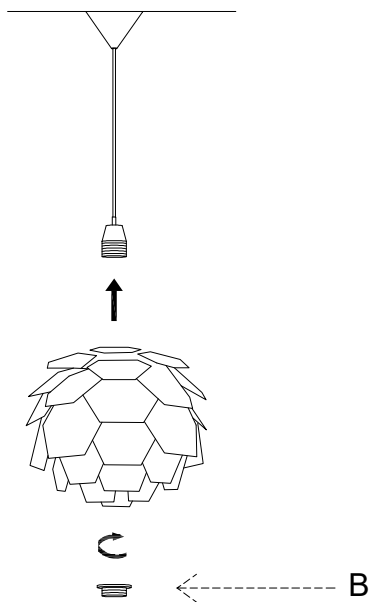
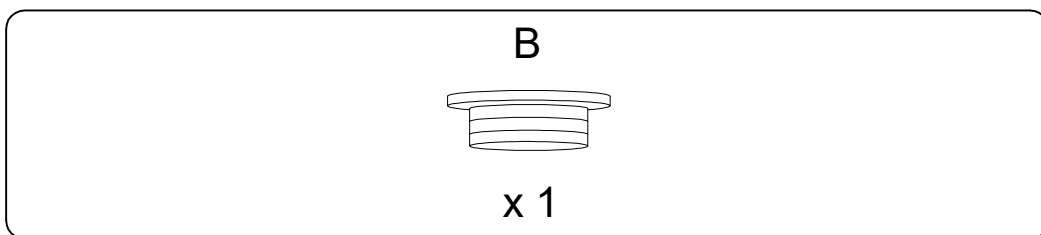

5

