



**PETTADORE**  
INTELLIGENT PETCARE

User Manual

# Nutri Turn

For other languages see  
[pettadore.com/pages/manuals](https://pettadore.com/pages/manuals)

*Please read this manual carefully before using. Keep the manual in a safe place for future reference.*

# 01 / Meet your Nutri Turn

---

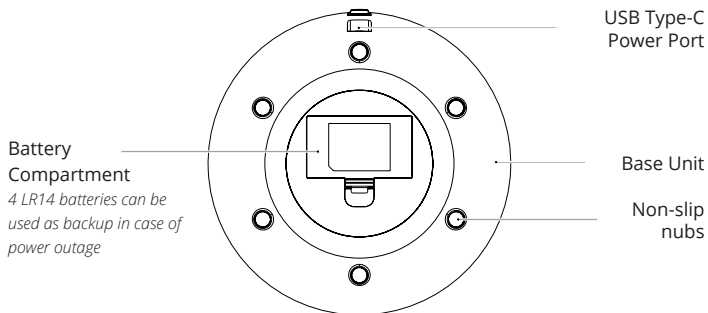
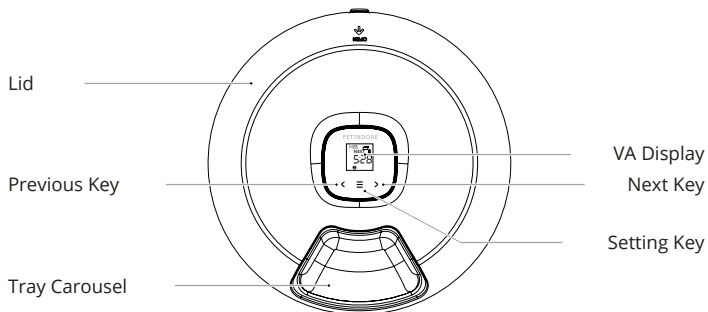

## 02 / Contents of the box

---

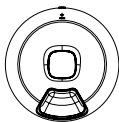

Nutri Turn

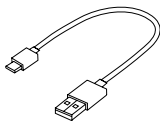

USB-C Cable  
(1.2 m)



Manual

## 03 / Operations

---

### 1) Power on the feeder

Unpack and connect the USB-C Cable to the power socket at the bottom. The LCD will light up.

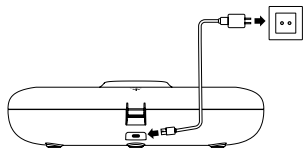

*\* The power supply is not included;  
please prepare yourself*

### 2) Open the lid

Slide the button to 'OPEN' to open the lid.

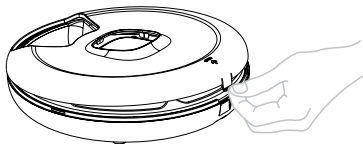

### 3) Fill with food

Fill each compartment with food.

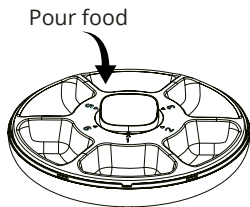

### 4) Close lid

Align the lid with the base at the sprung clip and press down.

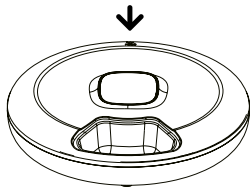

### 5) Manual feeding

Short press the '<' or '>' button to feed instantly.



### 6) Connect feeder with your phone and schedule your feeding.

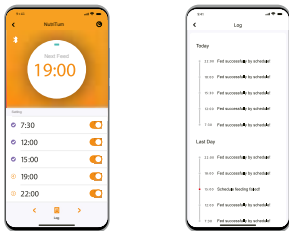

**Note:** Please hold down the '<' and '>' keys at the same time to unlock.

## Backup Battery Installation

Use a screwdriver to open the battery compartment cover at the bottom. Put four LR14 batteries inside (consider the positive and negative poles), Put the cover back on and tighten the screws.

**Note:** You need to buy the batteries separately, and only alkaline dry batteries are supported. Before installing, make sure that there is nothing in the food compartment. Install batteries for emergency backup in case of power failure. If the batteries are not used for a long time, please remove them.

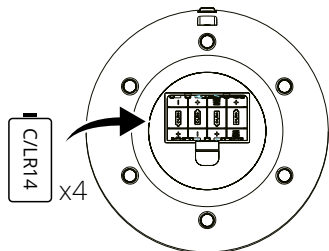

## 04 / Quick Setup

---

- 1) Scan the QR code or download the Pettadore App from App Store and Google Play. Sign up and sign in to the app.
- 2) Click the '+' button and be guided through the SET-UP steps.



**Notice:** Due to the upgrade and update of the Pettadore App, the actual operation may be slightly different from the above description. Please follow the instructions in the current Pettadore app!

## 05 / Manual Setting Explained

---



### Unlock

When locked, please hold down the “ < ” and “ > ” keys at the same time to unlock.



### Setting the system time

When unlocked, double-click the “ ≡ ” key until the HOUR digits flash, press the “ < ” and “ > ” key to set the hour, short press the “ ≡ ” key when finished. When the MINUTE digits flash, press “ < ” and “ > ” keys to set the minute, press the “ ≡ ” key to save.





### Feeding Plan Setting

When unlocked, short-press the “ ≡ ” button until you see the number 1 flashing. Short-press the “ ≡ ” button to see the HOUR digits of time flash. Set the first feeding time the same way you set the system time. After that, press the “ ≡ ” key to save and press “ > ” to set Number 2. Set the timer for all five meals in the same way. If you want to plan only three meals a day, after you set the 3rd feeding time, just press and hold to save and exit.

*\* It is recommended to set up a feeding plan in the mobile APP, which is simpler and more comfortable to operate.*

## 05 / Keys & Bluetooth Status

Bluetooth	Flashing	Disconnected
	Power Off	Connected
Keys	 Previous Key	Press briefly on the main menu; the tray rotates clockwise by one compartment. Press long to check the feeding schedule.
		Press briefly on the feeding schedule setting interface to change and set the meal number of the feeding schedule, reduce hours and minutes.
		Press briefly to review feeding plans, switch between feeding plans.
	 Setting Key	Double-click on the panel to set the device's time, short-press to set feeding plans, and press long for 5 seconds to restore the factory settings.
		Press briefly on the feeding plan setting interface to switch between hours and minutes, long-press to return to the main interface.
	 Next Key	Press briefly on the main menu; the tray will rotate counter-clockwise by one compartment. Long-press to review the feeding plans.
		Press briefly to switch between feeding plans, increase hours and minutes when setting time.
		Press briefly to review feeding plans, switch between feeding plans.

## 06 / Specifications

---

**Model:** PF006

**Power Input:** 5V 1A

**Communication:** Bluetooth

**Capacity Per Compartment:** 170ml (about 120g)

**Suitable Pets:** Cats and Small Sized Dogs

**Size:** 320x320x83mm

**Net Weight:** About 1134g

**Material:** ABS

**Quality Directive:** Q/TK 0022019

**Warranty:** 1 Year



**Pettadore**

Rijshoutstraat 4, 3361 EV

Slidrecht, The Netherlands



## 07 / Precautions

---

1. If the feeder is powered off and then powered on, the time setting needs to be reset.  
Method 1: Connect the feeder to the App. After the connection is established, the feeder will automatically synchronize the phone's time .  
Method 2: If the App is not connected, the time can be set in the setting menu of the feeder.
2. Never place other objects on the top of the feeder.
3. This feeder is suitable for both dry and wet food.
4. The base of the feeder must never be immersed in liquid.
5. If the feeder is not used for 5 minutes, it will automatically turn off the screen to save power.
6. Never fill food beyond the edge of the tray compartment to avoid malfunction.
7. When the feeder alerts on low battery, please replace the battery in time. If you are not going to use the device for a while, we recommend you to remove the batteries.
8. Please get the power cable covered or well-organized to make sure it cannot be chewed by pets.
9. This feeder is suitable for cats and small sized dogs.



**PETTADORE**

## 08 / Warranty Terms

---

Within the period of warranty, if the product fails with no fault of the user, it will be repaired at Pettadore's expense. The warranty does not cover product failure as described in the following examples:

1. Intentional damage to the product by the user or third party.
2. Failure to operate or maintain the product following the (QIG) Quick Installation Guide instructions.
3. Failure due to natural wear and tear including but not limited to scratching, corrosion, oxidation and rusting.
4. Failure due to non-authorized repair of the product including but not limited to user's own or third-party repairing attempts or modifications.

! For other languages see [pettadore.com/pages/manuals](http://pettadore.com/pages/manuals) !

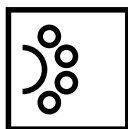

**PETTADORE**



INTELLIGENT PETCARE