

P max. 0,6 MPa
6 bar

0,12 - 0,4 MPa
1,2 - 4 bar

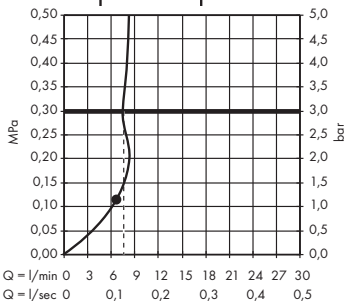

T max. 60 °C
< 50 °C



Croma Select S 1jet 26805400
Croma Select E 1jet 26815400

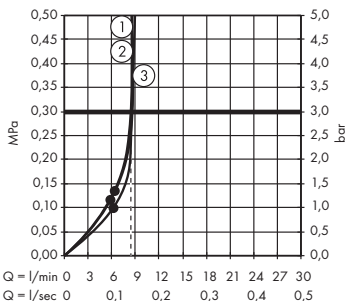

Croma Select S Vario 26803400
Croma Select E Vario 26813400

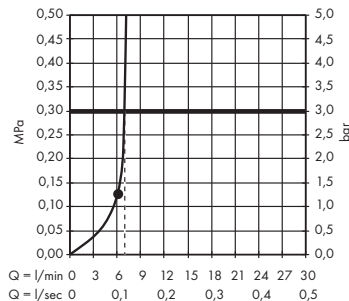

Croma Select S 1jet 26806400
Croma Select E 1jet 26816400

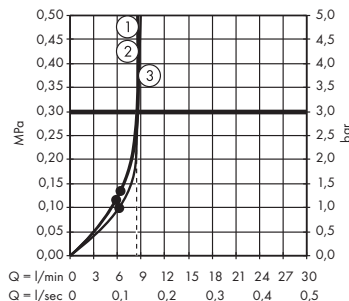

Croma Select S Multi 26801400
Croma Select E Multi 26811400



Croma Select S Vario 26803400
Croma Select E Vario 26813400
Croma Select S Multi 26801400
Croma Select E Multi 26811400

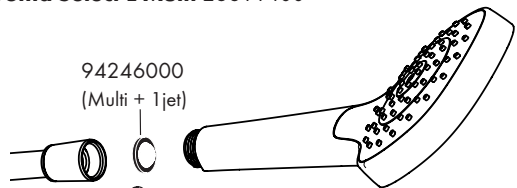
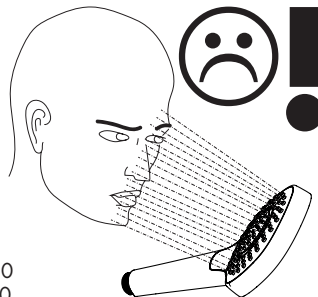

94246000
(Multi + 1jet)

98058000
(Vario)

92672000
(Vario)

	P-IX	NF	DVGW
26801400	P-IX 28499/IB		
26803400	P-IX 28500/IB	X	
26805400	P-IX 28501/IB		
26806400	P-IX 28501/IB		
26811400	P-IX 28502/IB		
26813400	P-IX 28503/IB	X	
26815400	P-IX 28504/IB		
26816400	P-IX 28504/IB		

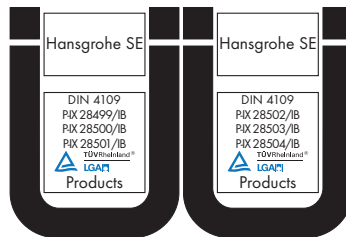

- DE** Montageanleitung
- FR** Instructions de montage
- EN** assembly instructions
- IT** Istruzioni per Installazione
- ES** Instrucciones de montaje
- NL** Handleiding
- DK** Monteringsvejledning
- PT** Manual de Instalação
- PL** Instrukcja montażu
- CS** Montážní návod
- SK** Montážny návod
- ZH** 组装说明
- RU** Инструкция по монтажу
- HU** Szerelési útmutató
- FI** Asennusohje
- SV** Monteringsanvisning
- LT** Montavimo instrukcijos
- HR** Uputstva za instalaciju
- TR** Montaj kılavuzu
- RO** Instrucțiuni de montare
- EL** Οδηγία συναρμολόγησης
- SL** Navodila za montažo
- ET** Paigaldusjuhend
- LV** Montāžas instrukcija
- SR** Uputstvo za montažu
- NO** Montasjeveiledning
- BG** Инструкция за употреба
- SQ** Udhëzime rreth montimit
- AR** تعليمات التجميع
- JP** 施工説明書

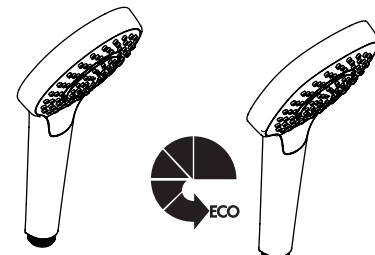

Croma Select S Multi 26801400
Croma Select S Vario 26803400
Croma Select S 1jet 26805400 / 26806400

Croma Select E Multi 26811400
Croma Select E Vario 26813400
Croma Select E 1jet 26815400 / 26816400

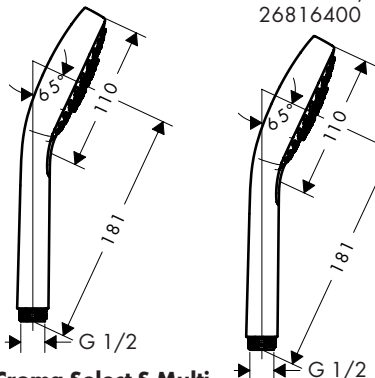

Croma Select S Multi 26801400
Croma Select S Vario 26803400
Croma Select S 1jet 26805400 / 26806400

Croma Select E Multi 26811400
Croma Select E Vario 26813400
Croma Select E 1jet 26815400 / 26816400

DE Reinigungsempfehlung / Garantie / Kontakt
FR Recommandation pour le nettoyage / Garanties / Contact
EN Cleaning recommendation / Warranty / Contact
IT Raccomandazione di pulizia / Garanzia / Contatto
ES Recomendaciones para la limpieza / Garantía / Contacto
NL Aanbevelingen inzake reiniging / Garantie / Contact
DK Rensning, anbefaling / Garanti / Kontakt
PT Recomendações de limpeza / Garantia / Contacto
PL Zalecenie dotyczący pielęgnacji / Gwarancja / Kontakt
CS Doporučení k čištění / Záruka / Kontakt
SK Odporúčania pre čistenie / Záruka / Kontakt
ZH 清洁指南 / 担保 / 接触
RU Рекомендации по очистке / Гарантия / Контакты
FI Puhdistussuositus / Takuu / Kosketus
SV Rengöringsrekommendationer / Garanti / Contacto
LT Valymo rekomendacijos / Garantija / Kontaktai
HR Preporuke za čišćenje / Garancija / Kontakt
TR Temizleme önerisi / Garanti / Temas
RO Recomandări pentru curățare / Garanție / Contact
EL Σύσταση καθαρισμού / γγύηση / επαφή
SL Priporočilo za čiščenje / Garancija / Kontakt
ET Puhastussuovitused / Garantii / Kontakt
LV Tīrīšanas ieteikumi / Garantija / Kontakti
SR Preporuke za čišćenje / Garancija / Kontakt
NO Anbefaling for rengjøring / Garanti / Kontakt
BG Препоръка за почистване / Гаранция / Контакт
SQ Këshilla rreth pastrimit / Garancia / Kontakt
KO 세정시 권장사항 / 품질보증 / 접촉
AR توصيات التنظيف / الضمان (الولايات المتحدة الأمريكية) / اتصال
HU Tisztítási tanácsok / Garancia / érintkezés
JP お手入れの方法 / 保証について / ご連絡先



www.hansgrohe.com/
cleaning-recommendation

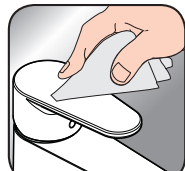

www.hansgrohe.com/
cleaning-recommendation



www.hansgrohe.com/
cleaning-recommendation



www.hansgrohe.com/
cleaning-recommendation

Service

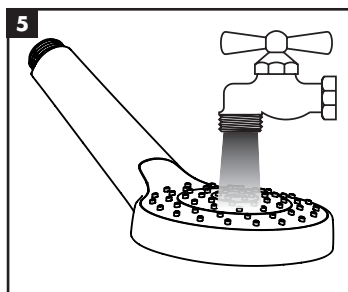
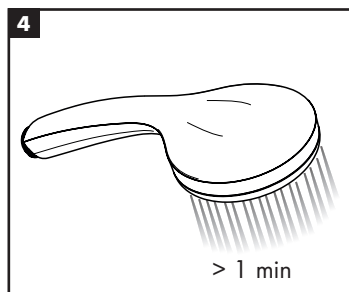
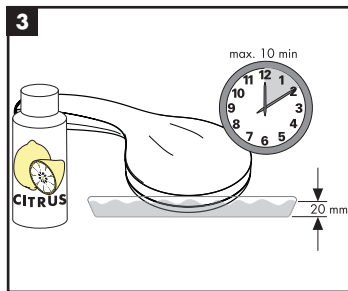
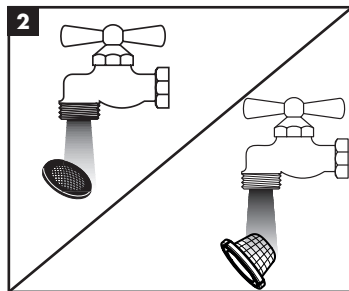
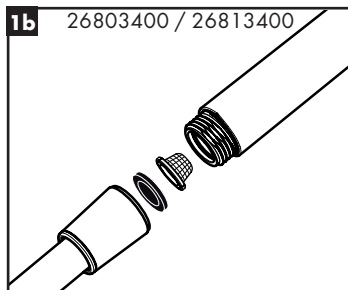
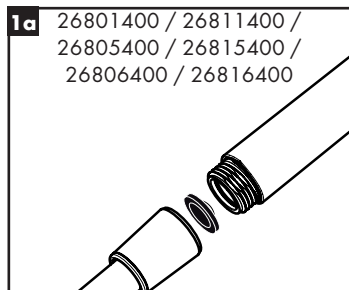

DE Einfach sauber: Kalk lässt sich von den Noppen ganz leicht abrubbeln.
FR La propreté en toute simplicité: les dépôts formés sur les buses élastiques en silicone s'éliminent par un simple passage de la main.
EN Just clean: simply rub over the spray nozzles to remove lime scale.
IT Facile da pulire: Il calcare viene eliminato semplicemente dagli ugelli elastici in silicone.
ES Fácil asear: La cal se puede retirar sencillamente frotando con los dedos de las toberas elásticas de silicona.
NL Eenvoudig schoon: Kalk kan eenvoudig van de noppen worden gewreven.
DK Enkel rengøring: Det er let at fjerne kalkaflejringer fra stråledyserne.
PT Simplesmente limpo: o calcário pode ser simplesmente retirado das saliências através de fricção.
PL Po prostu czysto: Pęczki można całkiem łatwo oczyścić z kamienia.
CS Jednoduše čisté: Vapenné usazeniny můžete z noplek snadno odstranit ořením.
SK Jednoducho čistý: Vodný kameň sa dá zo štetin celkom ľahko odstrániť.
ZH 清洁: 只需要揉搓花洒表面的出水孔即可去除水垢。
RU Простота чистки: известь очень легко стирается с утолщений.
FI Yksinkertaisesti puhdas: kalkin voi helposti hieroa irti nypistä.
SV Enkelt att göra rent: det är lätt att ta bort kalk från nopporna.
LT Paprasta švara: kalkės lengvai nugaravamos nuo kilpos.
HR Jednostavno čisto: Kamenac se savim lako uklanja s izbočina.
TR Sadece temiz: Kireç, düğümlemlerle kolayca ovalanabilir.

RO Pur și simplu curat: Calcarul se îndepărtează ușor de pe noduri prin frecare.
EL Απλά τέλεια καθαριότητα: Τα άλατα μπορούν να αφαιρεθούν με μεγάλη ευκολία από τα στόμια.
SL Preprosto čisto: arnenec se z lahkoto podrgne z vozličkov.
ET Lihtsalt puhas: lujja saab nuppu deli lihtsalt maha hõõruda.
LV Vienkārša tīrīšana: kaļķis no izvirzījumiem ir viegli norubināms.
SR Jednostavno čisto: Kamenac se savim lako skida sa izbočina.
NO Simpelten ren: Ved å gnikke er det lett å fjerne kalk fra nuppene.
BG Просто чисто: Варовикът лесно може да се изтресе от удебеленията.
SQ Thjesht dhe pastër. Mbetjet gëlqerore mund të hiqen me fërkim të lehtë.
AR إنه سهل التنظيف، حيث يسقط الجير بسهولة شديدة من الأجزاء الفائقة.
HU Egyszerűen tisztá: a vízkő egészen könnyen ledörzsölhető a csomókról.
JP 清掃が簡単: カルキは突起部から簡単にこすり落とすことができます。

