

Kensington®

Desktop & Peripherals Locking Kit 2.0

INSTRUCTION GUIDE
GUIDE D'INSTRUCTIONS
BEDIENUNGSANLEITUNG
HANDLEIDING
MANUALE DI ISTRUZIONI
MANUAL DE INSTRUCCIONES

HASZNÁLATI ÚTMUTATÓ
PŘÍRUČKA S POKYNY
INSTRUKCJA OBSŁUGI
РУКОВОДСТВО ПОЛЬЗОВАТЕЛЯ
MANUAL DE INSTRUÇÕES

دليل التعليمات

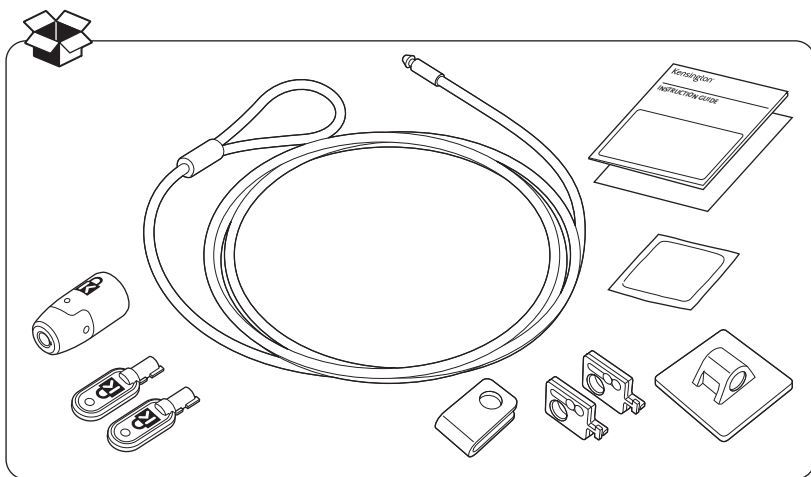

Register Now!
Enregistrer maintenant !
Jetzt registrieren!
Nu registreren
Registrar ahora
Registra adesso

Regiztráljon most!
Zaregistrujte se nyní!
Zarejestruj się!
Зарегістрироваться!
Registe-se agora!
سجل الآن!

www.kensington.com/register



IMPORTANT! REGISTER YOUR KEY CODE! /
IMPORTANT! ENREGISTREZ VOTRE CODE CLÉ! /
WICHTIG! REGISTRIEREN SIE IHREN KEYCODE! /
BELANGRIJK! REGISTREER UW SLEUTELCODE! /
IMPORTANTE! EFFETTUARE LA REGISTRAZIONE DEL
CODICE DELLA CHIAVE /
IMPORTANTE: REGISTRE EL CÓDIGO DE LA LLAVE /
FONTOS! REGISZTRÁLJA A KULCSKÓDJÁT! /
DŮLEŽITÉ! REGISTRUJTE KÓD SVÉHO KLÍČE! /
WAŻNE! ZAREJESTRUJ KOD KLUCZYKA! /
ВАЖНО! ЗАРЕГИСТРИРУЙТЕ СВОЙ КОД КЛЮЧА! /
IMPORTANTE! FAÇA O REGISTO DO SEU CÓDIGO CHAVE! /
مهم! تسجيل رمز المفتاح الخاص بك!

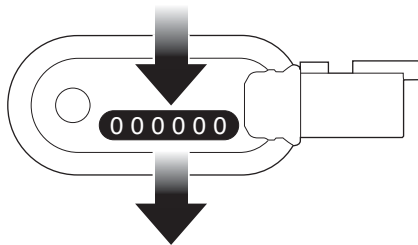

www.kensington.com/register

#

<input type="text"/>	<input type="text"/>	<input type="text"/>	<input type="text"/>	<input type="text"/>	<input type="text"/>
----------------------	----------------------	----------------------	----------------------	----------------------	----------------------

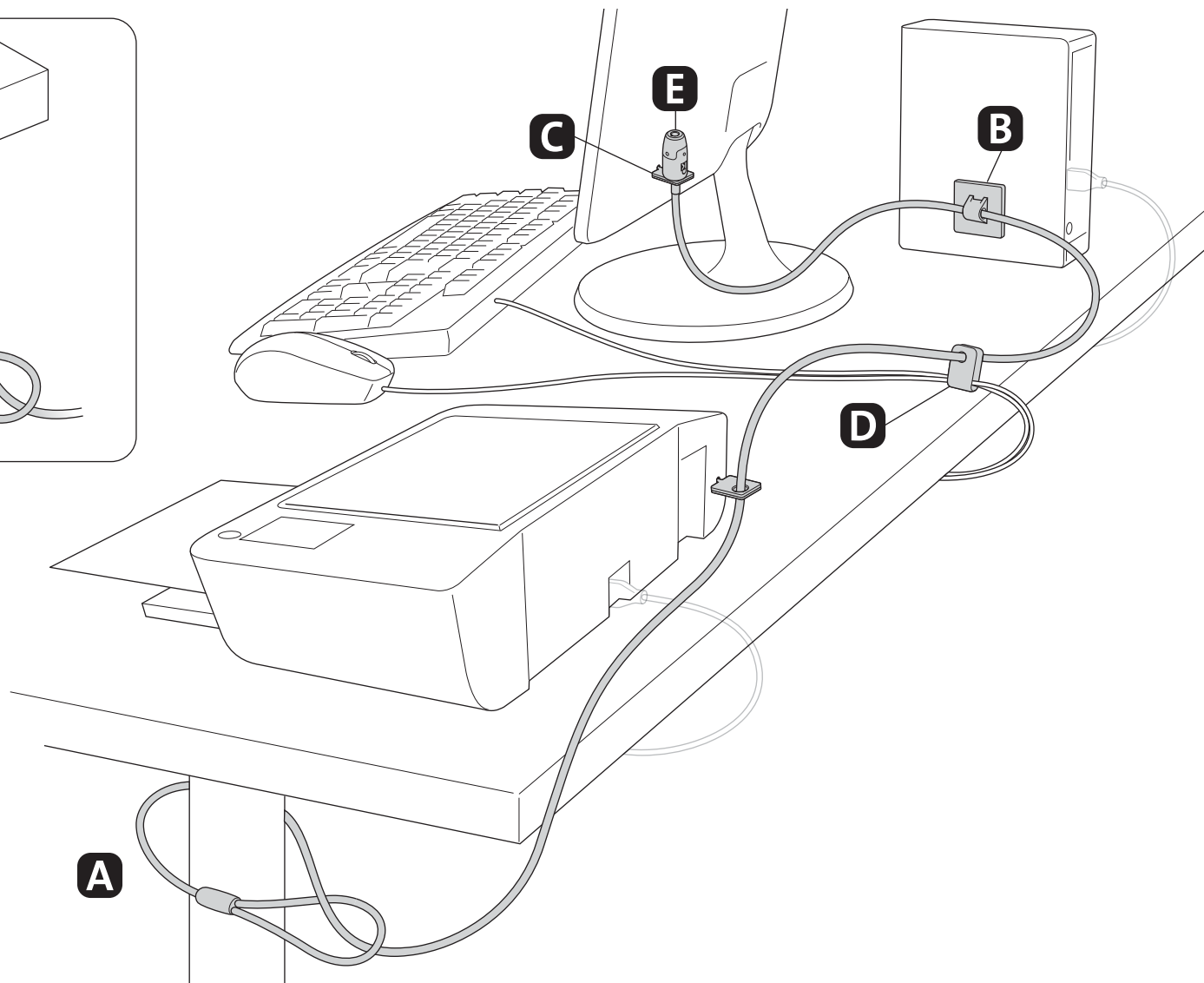
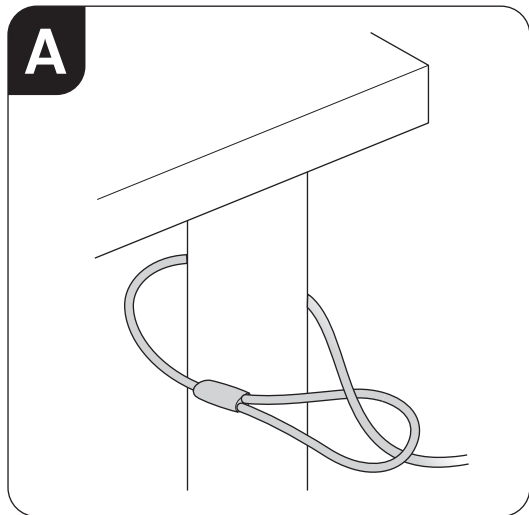

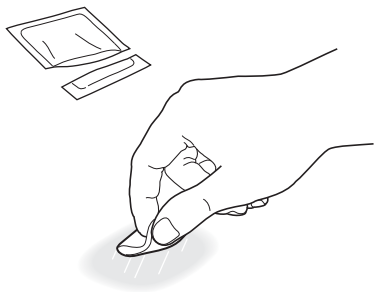
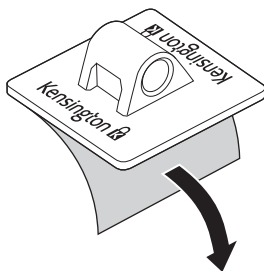
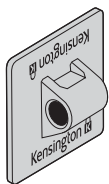
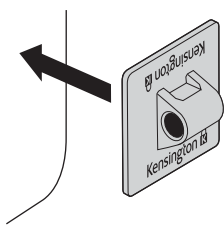
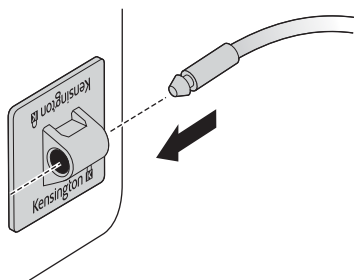
B**1****2****3****4**

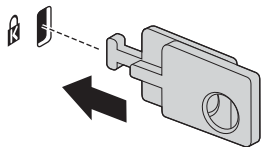
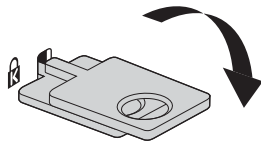
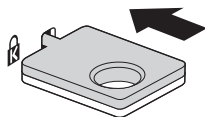
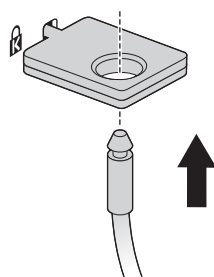
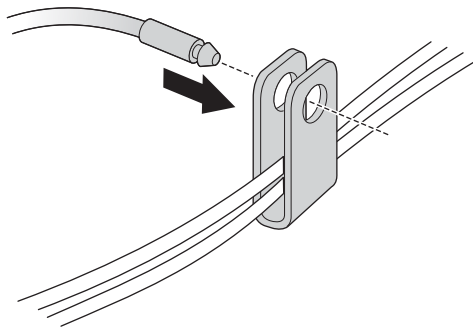
C**1****2****3****4****D**

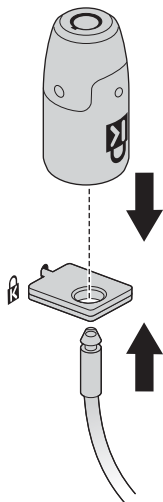
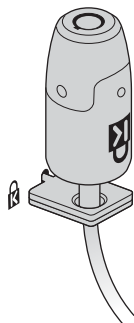
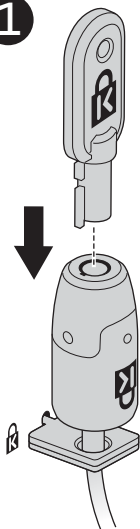
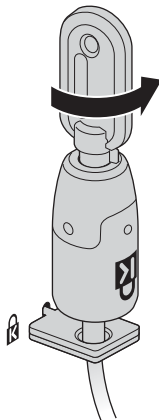
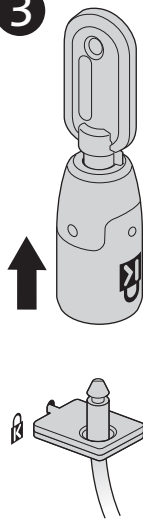
E**1****2****1****2****3**

Sold separately. Visit www.kensington.com /
Vendu séparément. Visitez le site www.kensington.com /
Wird separat verkauft. Weitere Informationen finden Sie unter www.kensington.com /
Afzonderlijk verkrijgbaar. Ga naar www.kensington.com /
Disponibile separatamente. Visitare il sito www.kensington.com /
Se venden por separado. Visite www.kensington.com /
Külön értékesítve. Keresse fel a www.kensington.com /
Lze zakoupit zvlášť. Navštivte www.kensington.com /
Sprzedawane osobno. Odwiedź witrynę www.kensington.com /
Продается отдельно. Более подробную информацию см. на сайте www.kensington.com /
Vendido em separado. Visite www.kensington.com /
www.kensington.com يُباع بشكل منفصل. تفضل بزيارة

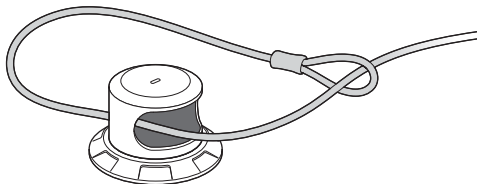

K64162

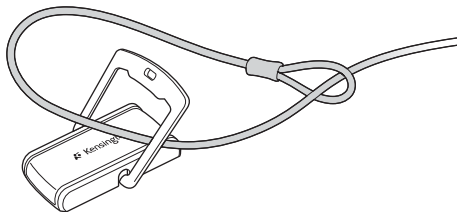

K64163

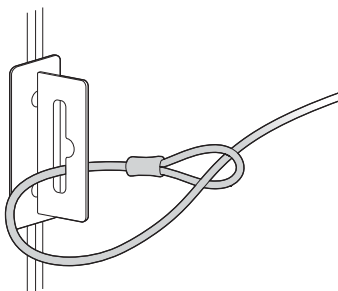

K67700

Kensington and the ACCO name and design are registered trademarks of ACCO Brands. All other registered and unregistered trademarks are the property of their respective owners.

©2017 Kensington Computer Products Group, a division of ACCO Brands. Any unauthorized copying, duplicating, or other reproduction of the contents hereof is prohibited without written consent from Kensington Computer Products Group. All rights reserved. 02/17



Kensington Computer Products Group
A Division of ACCO Brands
1500 Fashion Island Blvd, 3rd Floor
San Mateo, CA 94404



ACCO Brands Europe
A Division of ACCO Brands Europe
Oxford House, Oxford Road
Aylesbury, Buckinghamshire,
HP21 8SZ
United Kingdom

ACCO Brands Canada Inc
7381 Bramalea Rd
Mississauga,
ON L5S 1C4
Canada

ACCO Brands Australia - Kensington
2 Coronation Avenue
Kings Park NSW 2148
Australia

Importado por ACCO Mexicana
S.A. de C.V.
Circuito de la Industria Norte # 6,
Corredor Industrial Toluca Lerma,
Lerma México Cp. 52004
R.F.C. AME640229-1W3

Acco Brands Chile S.A.,
Avda. San Josemaria
Escrivá de Balaguer N°5773
Vitacura, C.P. 7640970
Santiago, Chile

Importado e Distribuído por:
TILIBRA PRODUTOS DE PAPELARIA LTDA.
CNPJ: 44.990.901/0001-43
Rua Aymorés, 6-9 – Bauru/SP – Brasil
CEP 17013-900

www.kensington.com

K64424/K64425/K67990

901-9318-00