



USER MANUAL

Klipsch®

REFERENCE
PREMIERE



REFERENCE (n):

- 1) the standard, the benchmark, the point used for comparison
- 2) the embodiment of the legendary Klipsch sound

LOUD AND PROUD SINCE 1946

In 1946, Paul W. Klipsch revolutionized the audio industry by creating our proprietary horn technology and the acoustic principles that are the driving force behind our highly acclaimed signature sound. Today, we remain true to PWK's vision and pack the better part of a century's worth of sweat and genius into every product we make. These speakers are the result of our obsession with that aural perfection. Experience the power, detail and emotion of Klipsch Reference Series.

We are the Keepers of the Sound®.



REFERENCE PREMIERE SPEAKERS



RP-8060FA



RP-8000F



RP-6000F



RP-5000F



RP-4000F



RP-600M



RP-500M



RP-400M

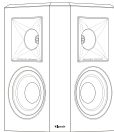

RP-502S

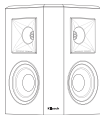

RP-402S



RP-500SA



RP-504C



RP-404C



RP-600C

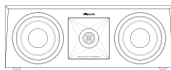

RP-500C

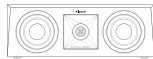

RP-400C

BEFORE YOU START

Some Klipsch® speakers have feet and other accessories that may need to be installed prior to use. Please refer to Diagrams 1, 2, 3 and 4 for installation.

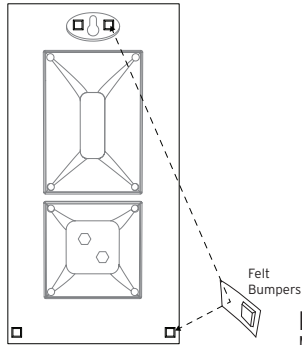

DIAGRAM 1
MONITOR WALL MOUNT

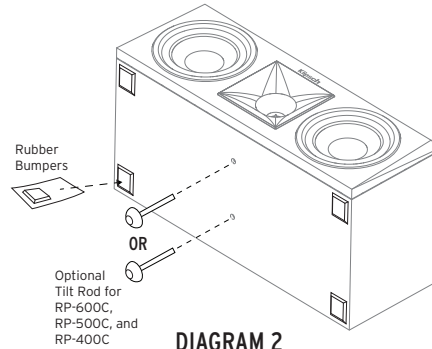

DIAGRAM 2
CENTER CHANNELS

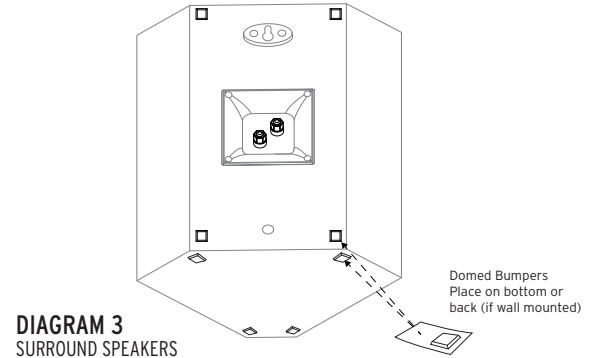

DIAGRAM 3
SURROUND SPEAKERS

ROOM PLACEMENT

Left and Right Main Channel Speakers – For optimum performance, Klipsch Group, Inc. (KGI) suggests placing your speakers 6 to 15 feet (1.8 to 4.6m) apart. They may also be toed-in slightly for better stereo imaging. The listening position should be about 1 to 1.5 times the distance separating the speakers. Refer to Figures 1 and 3 for connection and placement.

Center Channel Speakers – Center channel speakers are designed to place dialogue and primary sounds so that they appear to come from the video screen. The speakers should therefore be placed as close to the screen as possible, preferably directly on top of or below the screen. Refer to Figures 1, 2 and 3 for connection and placement.

Rear Surround Channel Speakers – Klipsch WDST surround speakers should be placed approximately 2 feet above the listening position. Typically this will be about 5-7 feet above the floor. The surrounds should be placed on the walls directly adjacent to the listening position. Another option would be on the wall behind the listening position. The final surround speaker placement depends on your room's characteristics. They are designed to recreate the sense of space and ambience that many of today's surround sound technologies provide. Refer to Figures 1, 3 and 4 for connection and placement.

CONNECTION

Conventional Connection – Using 16-12 gauge speaker wire, connect the RED "positive" (+) terminal of the LEFT speaker to the RED "positive" (+) terminal of your amplifier's LEFT channel. Connect the BLACK "negative" (-) terminal of the LEFT speaker to the BLACK "negative" (-) terminal of your amplifier's LEFT channel. Repeat this procedure for connecting all remaining speakers to the appropriate amplifier channels. Refer to Figure 3. Make sure that no bare wires from any of the connections touch any other terminals as this could cause a short and damage your equipment.

Reference Premiere models RP-8060FA, RP-8000F, RP-6000F, RP-5000F, RP-4000F and RP-160M are equipped with dual binding posts. If single wire connection is used, the terminal connecting bar should remain in place. If Bi-wire or Bi-amp connection is used, the terminal connecting bar must be removed. Please see your receiver's manual for further instructions.

Amplifier Requirements – Klipsch speakers are highly efficient and will operate easily on a wide variety of amplifiers. All Klipsch speakers are 8-ohm compatible and can be driven to very high levels with low distortion. Due to the high output levels Klipsch speakers are capable of reproducing, exercise caution with the volume control. Excessive volume over long periods can permanently damage your hearing. Overdriving your amplifier could also damage your speakers. Check with your dealer or amplifier manual to make sure your particular amplifier is best suited to your application. We want you listening for a lifetime.

FIGURE 1
SPEAKER PLACEMENT IN LISTENING AREA

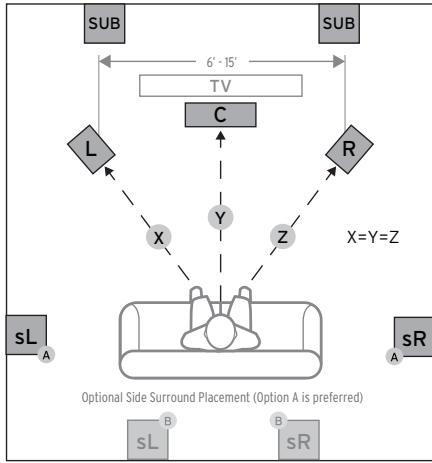

FIGURE 2
CENTER CHANNEL

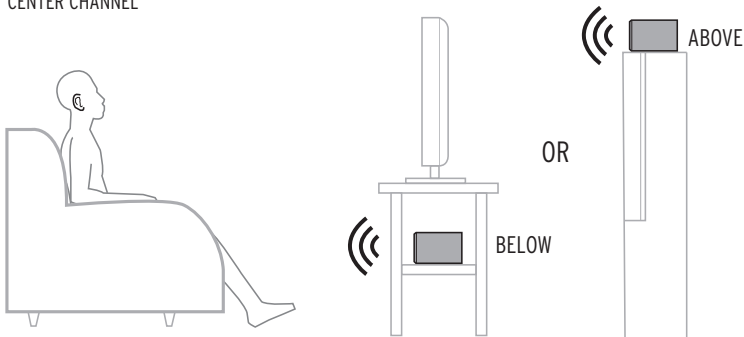

FIGURE 3
STANDARD CONNECTIONS

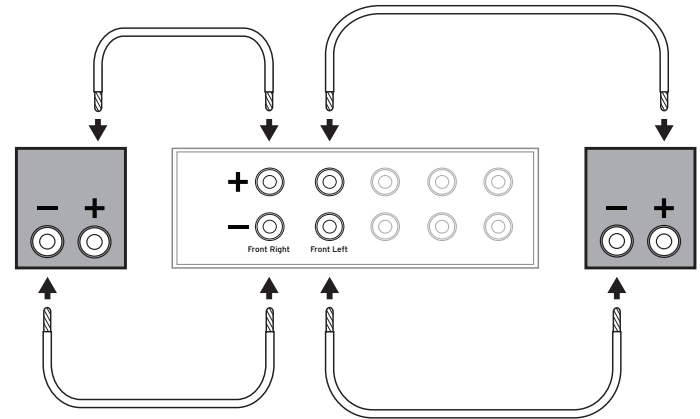
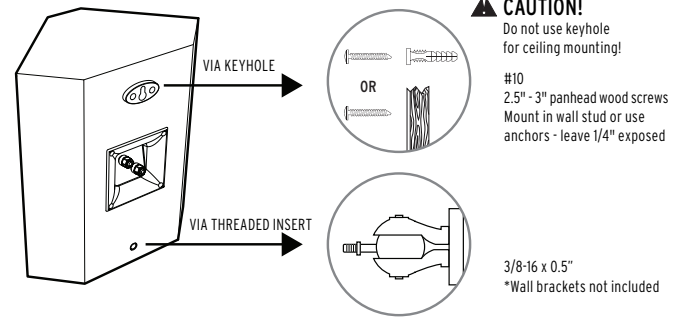
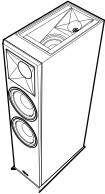

FIGURE 4
WALL MOUNTING



REFERENCE PREMIERE WITH DOLBY ATMOS® TECHNOLOGY



RP-8060FA

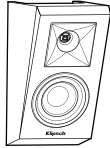

RP-500SA

- 1 ATMOS FRONT
- 2 ATMOS REAR
- 3 SIDE SURROUND
- 4 REAR SURROUND

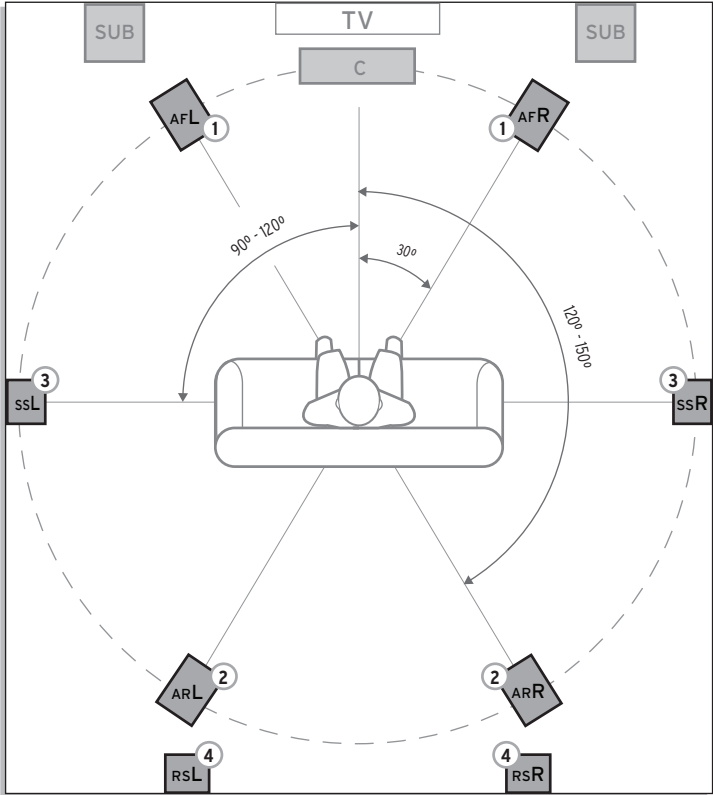
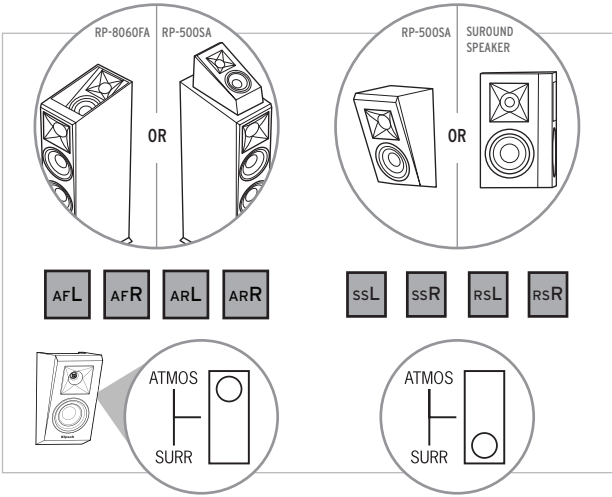

SPEAKER PLACEMENT IN LISTENING AREA

REFERENCE PREMIERE WITH DOLBY ATMOS® TECHNOLOGY

CONNECTIONS

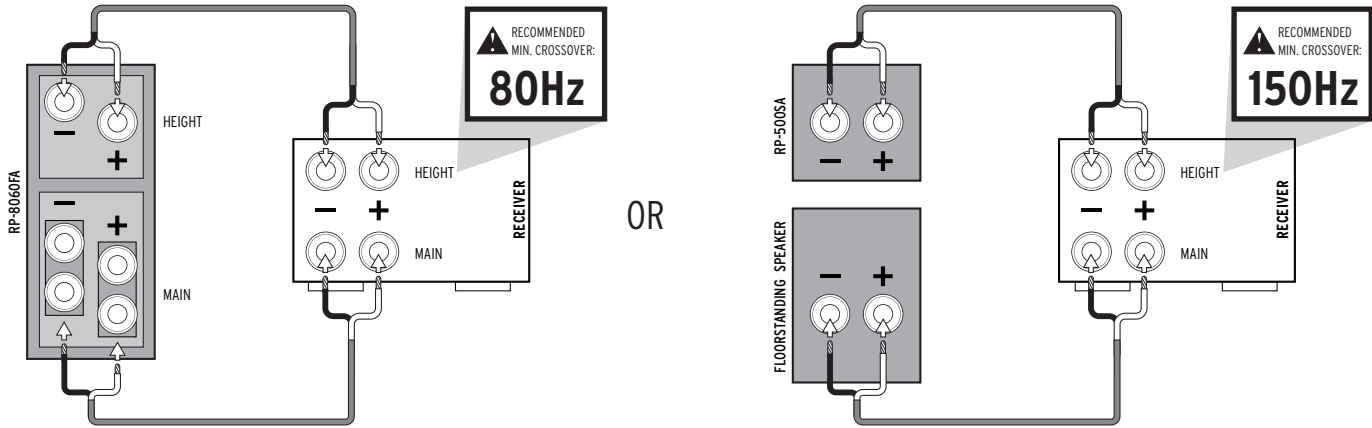

ELEVATION SPEAKER

The RP-500SA can be added to any passive loudspeaker setup.

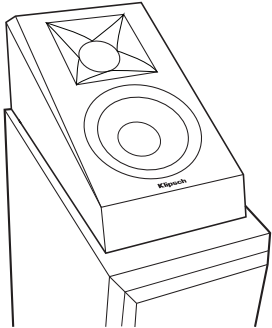

WALL MOUNTING

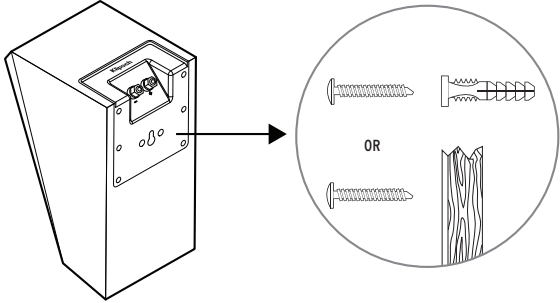

CAUTION!
Do not use keyhole for ceiling mounting!
#10
2.5" - 3" panhead wood screws
Mount in wall stud or use anchors - leave 1/4" exposed

CARE AND CLEANING

The only thing you should ever need to do to your speakers is dust them occasionally. Never apply any abrasive or solvent-based cleaner or any harsh detergent. You can clean the grilles with the brush attachment of a vacuum cleaner.

PRODUCT REGISTRATION

Register your product online at www.klipsch.com/register

- Keep up-to-date on new products and promotions.
- Your personal information will never be resold.
- This registration information is not used for warranty purposes.

Please retain your receipt for warranty claims.

REFERENCE

FRANÇAIS

1) le standard, l'étalon, le repère utilisé à des fins de comparaison

2) la concrétisation du son légendaire de Klipsch

FORT ET FIER DEPUIS 1946

En 1946, Paul W. Klipsch a révolutionné l'industrie du son en créant notre technologie exclusive de pavillon et en établissant les principes acoustiques sur lesquels repose notre son caractéristique tant prisé. Aujourd'hui, nous restons fidèles à la vision de PWK et incorporons près d'un siècle de sueur et de génie dans chaque produit que nous fabriquons. Ces enceintes sont le résultat de nos décennies d'obsession pour cette perfection sonore. Découvrez la puissance, le détail et l'émotion des enceintes Reference de Klipsch.

Klipsch, Keepers of the Sound®.



ENCEINTES REFERENCE PREMIERE



RP-8060FA

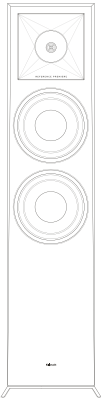

RP-8000F



RP-6000F



RP-5000F



RP-4000F



RP-600M



RP-500M



RP-400M

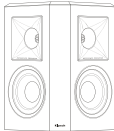

RP-502S



RP-402S



RP-500SA

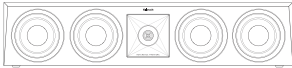

RP-504C



RP-404C



RP-600C



RP-500C

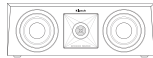

RP-400C

AVANT DE COMMENCER

Certaines enceintes Klipsch® ont des pieds et d'autres accessoires qu'il pourra falloir installer avant l'utilisation. Veuillez vous reporter aux schémas 1, 2, 3, et 4 pour l'installation.



SCHÉMA 1
FIXATION MURALE



SCHÉMA 2
VOIE CENTRALE

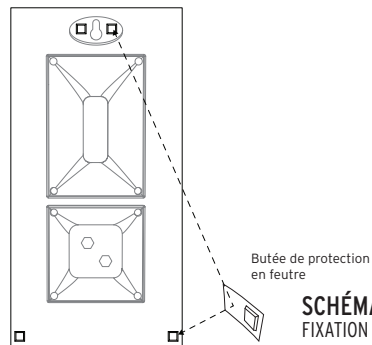

SCHÉMA 3
ENCEINTES SURROUND

POSITIONNEMENT DANS LA PIÈCE

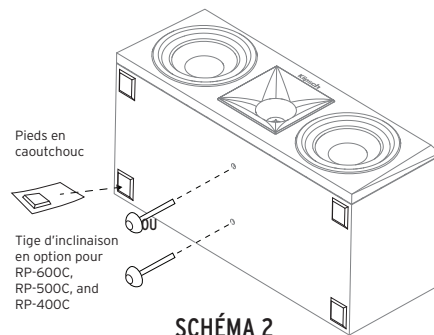
Enceintes des voies principales gauche et droite – Pour obtenir les meilleurs résultats, Klipsch Group, Inc. (KGI) suggère de placer vos enceintes à une distance de 1,8 à 4,6 m l'une de l'autre, et à au moins 61 cm des murs de la pièce. Elles peuvent également être légèrement tournées l'une vers l'autre pour une meilleure restitution stéréo. La position d'écoute devrait se situer à environ 1 à 1,5 fois la distance séparant les enceintes. Reportez-vous aux figures 1 et 3 pour le branchement et le positionnement.

Enceintes de voie centrale – Les enceintes de voie centrale sont conçues pour diffuser les dialogues et les sons principaux de manière à ce qu'ils semblent provenir de l'écran vidéo. Les enceintes devraient par conséquent être placées aussi près que possible de l'écran, de préférence directement au-dessus ou en dessous de l'écran. Reportez-vous aux figures 1, 2 et 3 pour le branchement et le positionnement.

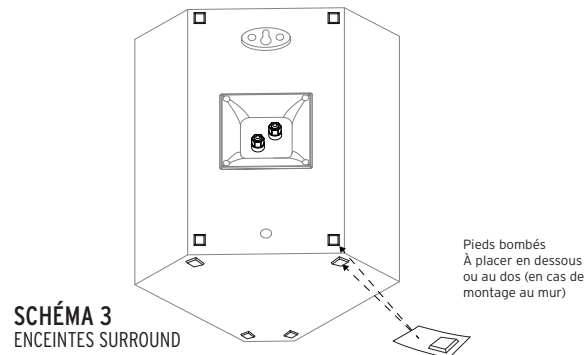
Enceintes des voies surround arrière – Les enceintes surround Klipsch WDST devraient être placées à environ 60 cm au-dessus de la position d'écoute. Généralement, cela correspond à une hauteur d'environ 1,50 m à 2,10 m au-dessus du sol. Les enceintes surround devraient être placées sur les murs directement adjacents à la position d'écoute. Une autre option consiste à les installer sur le mur situé derrière la position d'écoute. Le positionnement des enceintes surround dépend des caractéristiques de votre pièce. Elles sont conçues pour recréer la sensation d'espace et d'ambiance que fournissent beaucoup des technologies de son surround d'aujourd'hui. Reportez-vous aux figures 1, 3 et 4 pour le branchement et le positionnement.

BRANCHEMENT

Branchement conventionnel – En utilisant du fil d'enceinte d'un diamètre minimum de 1,3 mm (16 AWG), reliez la borne « positive » (+) ROUGE de l'enceinte de GAUCHE à la borne « positive » (+) ROUGE de la voie de GAUCHE de votre amplificateur. Reliez la borne « négative » (-) NOIRE de l'enceinte de GAUCHE à la borne « négative » (-) NOIRE de la voie de GAUCHE de votre amplificateur. Répétez cette procédure pour brancher toutes les enceintes restantes aux voies appropriées de l'amplificateur. Reportez-vous à la figure 3. Veillez à ce qu'aucun des fils dénudés utilisés pour les branchements ne touche une autre borne, étant donné que cela pourrait provoquer un court-circuit et endommager votre équipement.

Les modèles Reference Première RP-8060FA, RP-8000F, RP-6000F, RP-5000F, RP-4000F et RP-160M sont équipés de bornes de raccordement jumelées. Dans le cas d'un raccord avec un seul câble, la barre de raccord de la borne doit rester en place. Dans le cas d'un raccord double amplification ou à deux câbles (bi-câblage), la barre de raccord de la borne doit être retirée. Veuillez consulter le manuel de votre amplificateur pour de plus amples instructions.

Exigences relatives à l'amplificateur – Les enceintes Klipsch sont extrêmement efficaces et fonctionneront aisément avec un large éventail d'amplificateurs. Toutes les enceintes Klipsch ont une impédance de 8 ohms et peuvent fonctionner à très haute puissance avec peu de distorsion. Compte tenu des niveaux sonores élevés que les enceintes Klipsch sont capables de restituer, soyez prudent avec le réglage du volume. Un volume excessif pendant de longues durées peut causer des dommages irréversibles de l'ouïe. Une surcharge de votre amplificateur pourrait également endommager vos enceintes. Consultez votre revendeur pour vous assurer que votre amplificateur est adapté à votre application. Nous voulons que vous écoutiez pendant toute votre vie.

FIGURE 1
POSITIONNEMENT DES ENCEINTES DANS LA ZONE D'ÉCOUTE

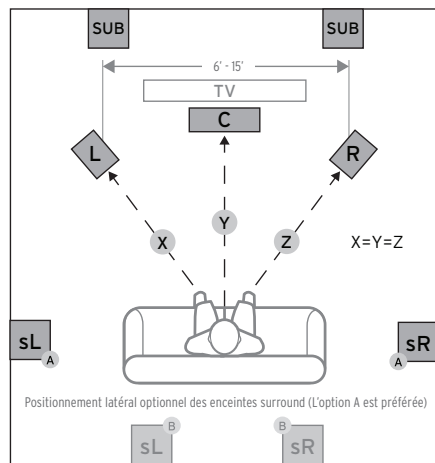

FIGURE 2
VOIE CENTRALE

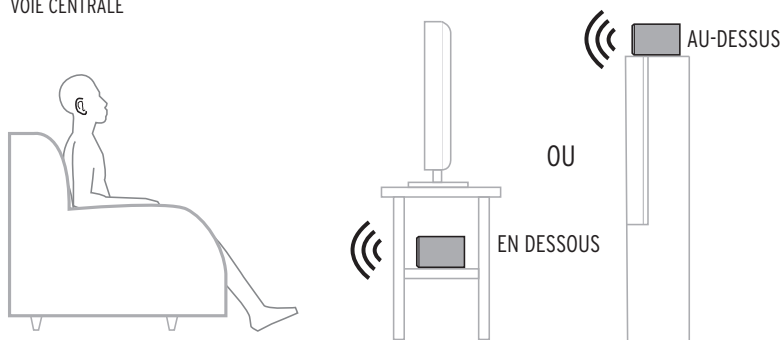

FIGURE 3
BRANCHEMENTS STANDARD

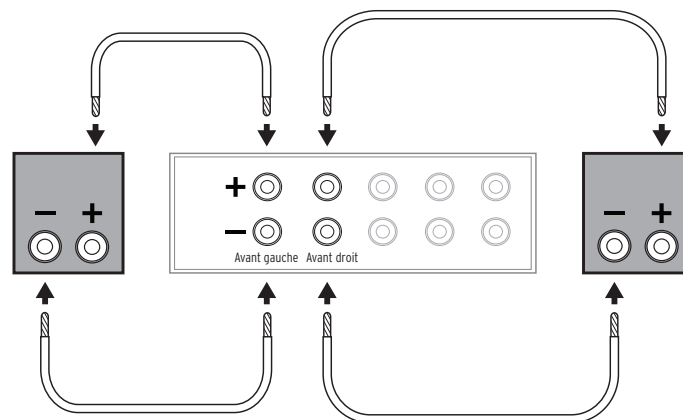
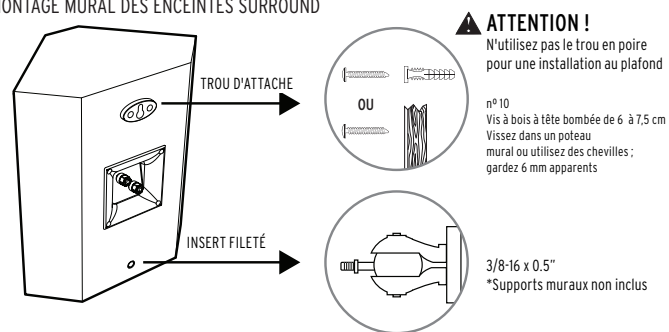
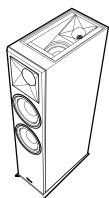

FIGURE 4
MONTAGE MURAL DES ENCEINTES SURROUND



REFERENCE PREMIERE AVEC LA TECHNOLOGIE DOLBY ATMOS®



RP-8060FA

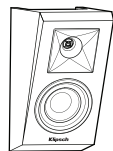

RP-500SA

- 1 ATMOS FRONT
- 2 ATMOS REAR
- 3 SIDE SURROUND
- 4 REAR SURROUND

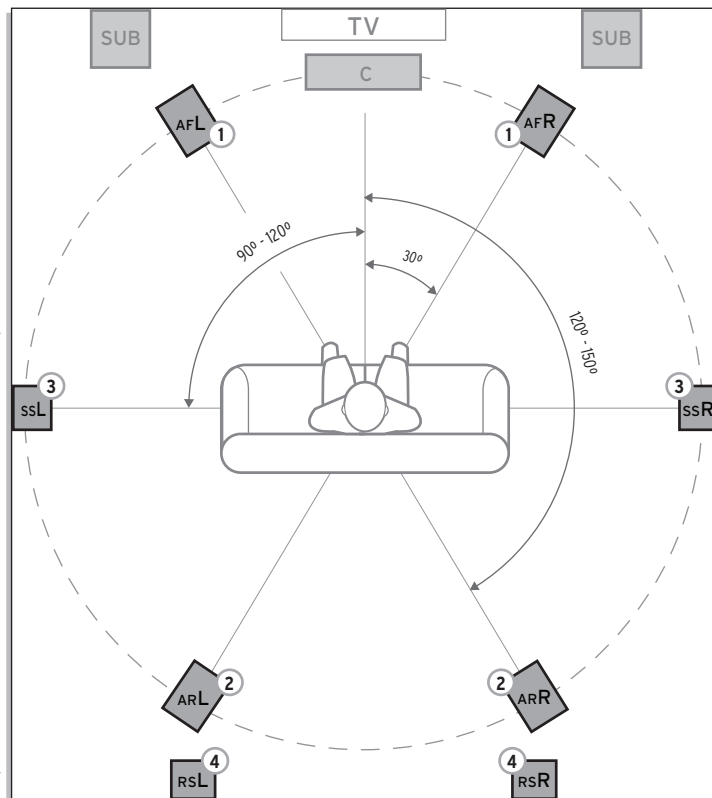
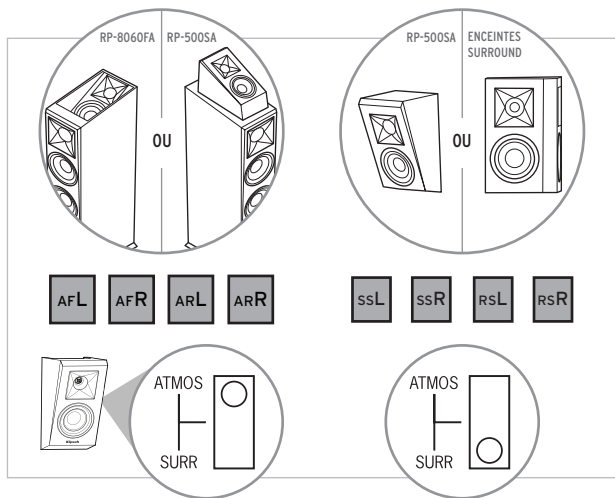

POSITIONNEMENT DES ENCEINTES DANS LA ZONE D'ÉCOUTE

REFERENCE PREMIERE AVEC LA TECHNOLOGIE DOLBY ATMOS®

BRANCHEMENTS

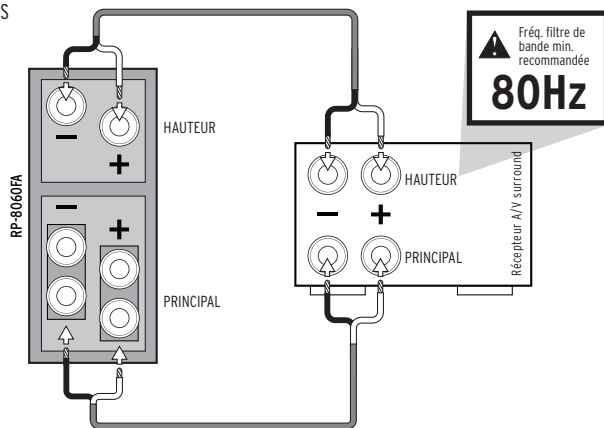

OU

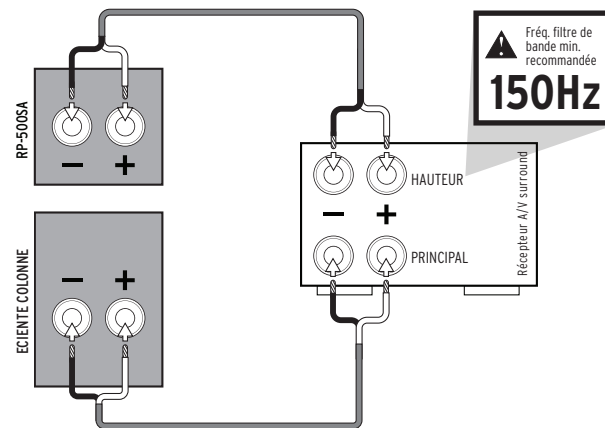

ECIENTE D'ÉLÉVATION

Il est possible d'ajouter le RP-500SA à une installation d'enceintes passive.

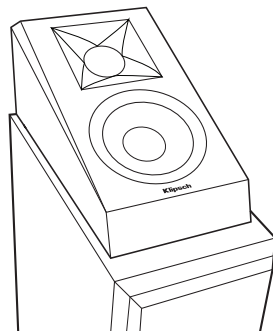

MONTAGE MURAL DES ENCEINTES SURROUND

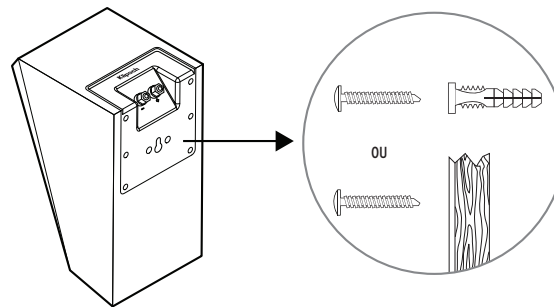

ATTENTION !
N'utilisez pas le trou en poire pour une installation au plafond

n° 10
Vis à bois à tête bombée de 6 à 7,5 cm
Vissez dans un poteau mural ou utilisez des chevilles ;
gardez 6 mm apparents

ENTRETIEN ET NETTOYAGE

La seule chose que vous devriez avoir besoin de faire pour vos enceintes est de les épousseter occasionnellement. N'utilisez jamais de produits de nettoyage abrasifs ou à base de solvant, ni aucun détergent agressif. Vous pouvez nettoyer les grilles avec la brosse d'un aspirateur.

ENREGISTREMENT DU PRODUIT

Enregistrez votre produit en ligne à www.klipsch.com/register

- Restez informé des nouveaux produits et des promotions.
- Vos informations personnelles ne seront jamais revendues.
- Ces informations d'enregistrement ne sont pas utilisées à des fins de garantie.

Veillez conserver votre reçu pour toute réclamation au titre de la garantie.

REFERENCE

DEUTSCH

1) Der Standard, der Maßstab, der Vergleichspunkt

2) Die Verkörperung des legendären
Klipsch-Sounds

LAUT UND STOLZ SEIT 1946

Im Jahre 1946 revolutionierte Paul W. Klipsch die Audioindustrie, indem er unsere proprietäre Hornlautsprecher-Technologie und die akustischen Prinzipien entwickelte, die die treibende Kraft unseres berühmten Sounds darstellen. Auch heute noch folgen wir der Vision von PWK und jedes von uns hergestellte Produkt baut auf jahrzehntelanger Arbeit und Kreativität auf. Diese Lautsprecher sind das Produkt unseres langjährigen Strebens nach akustischer Perfektion. Erleben Sie die Leistung, die Präzision und die Emotion von Klipsch Reference.

We are the Keepers of the Sound®.



REFERENCE PREMIERE-LAUTSPRECHER

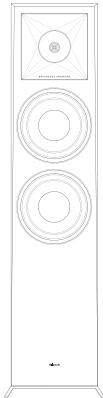

RP-8060FA

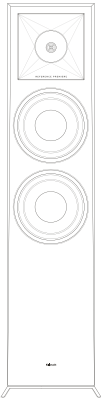

RP-8000F



RP-6000F



RP-5000F



RP-4000F



RP-600M



RP-500M



RP-400M

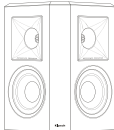

RP-502S



RP-402S



RP-500SA

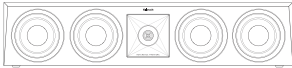

RP-504C



RP-404C



RP-600C



RP-500C

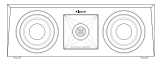

RP-400C

ERSTE SCHRITTE

Manche Klipsch® Lautsprecher verfügen über FüÙe oder anderes Zubehöör, das vor der Benutzung installiert werden muss. Installationshinweise finden Sie in Diagramm 1, 2, 3, und 4.



DIAGRAMM 1
WANDMONTAGE



DIAGRAMM 2
CENTER-KANAL

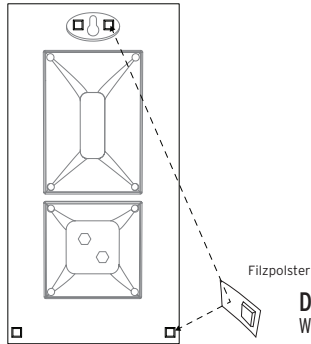

DIAGRAMM 3
SURROUND-LAUTSPRECHER

AUFSTELLUNG IM RAUM

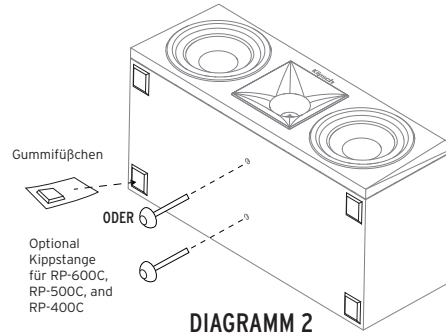
Linke und rechte Hauptkanal-Lautsprecher - Zur optimalen Leistung empfiehlt Klipsch Group, Inc. (KGI), dass Sie die Lautsprecher 1,8 bis 4,6 m voneinander entfernt und mindestens 61 cm von den Rück- und Seitenwänden aufstellen. Um ein besseres Stereoklangbild zu erhalten, sollten Sie sie eventuell etwas nach innen ausrichten. Der Abstand der Hörpositionen sollte etwa 1 bis 1,5 mal so groß wie der Abstand der Lautsprecher voneinander sein. Abbildungen 1 und 3 zeigen Ihnen die korrekten Anschlüsse und Platzierungen.

Center-Kanal-Lautsprecher - Center-Kanal-Lautsprecher dienen dazu, Dialog und primären Sound so wiederzugeben, dass sie vom Videobildschirm zu kommen scheinen. Diese Lautsprecher sollten deshalb so nahe wie möglich am Bildschirm platziert werden, am besten direkt über oder unter dem Bildschirm. Abbildungen 1, 2 und 3 zeigen Ihnen die korrekten Anschlüsse und Platzierungen.

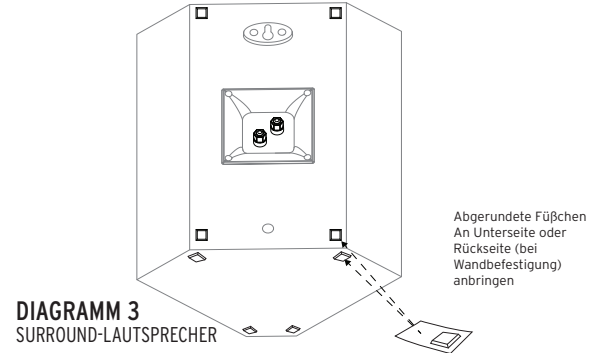
Hintere Surround-Lautsprecher - Klipsch WDST Surround-Lautsprecher sollten ungefähr 60 cm über der Hörposition platziert werden. Normalerweise ist das 1,5-2 m über dem Boden. Die Surround-Lautsprecher sollten an Wänden und in unmittelbarer Nähe der Hörposition platziert werden. Eine weitere Option wäre die Wand hinter der Hörposition. Letztlich hängt die Platzierung des Surround-Lautsprechers von den Eigenschaften Ihres Raums ab. Die Lautsprecher erzeugen den durch die moderne Surround-Sound-Technologie ermöglichten Raumklang. Abbildungen 1, 3 und 4 zeigen Ihnen die korrekten Anschlüsse und Platzierungen.

ANSCHLÜSSE

Konventioneller Anschluss - Verwenden Sie 16-Gauge-Lautsprecherkabel (oder dicker) und verbinden Sie den ROTEN, positiven (+) Anschluss des LINKEN Lautsprechers mit dem ROTEN, positiven (+) Anschluss des LINKEN Kanals Ihres Verstärkers. Verbinden Sie den SCHWARZEN, negativen (-) Anschluss des LINKEN Lautsprechers mit dem SCHWARZEN, negativen (-) Anschluss des LINKEN Kanals Ihres Verstärkers. Wiederholen Sie dieses Verfahren für den Anschluss aller verbleibenden Lautsprecher an die entsprechenden Verstärkerkanäle. Siehe Abbildung 3. Vergewissern Sie sich, dass kein blanker Draht von einem der Anschlüsse andere Klemmen berührt, da dies einen Kurzschluss hervorrufen und Ihre Geräte beschädigen könnte.

Die Reference Premiere-Modelle RP-8060FA, RP-8000F, RP-6000F, RP-5000F, RP-4000F und RP-160M verfügen über doppelte Anschluss terminals . Wenn eine Einkabel-Verbindung benutzt wird, sollte der Verbindungstreifen an Ort und Stelle bleiben. Bei einer Bi-Wiring- oder Bi-Amping-Verbindung muss der Verbindungstreifen entfernt werden. Weitere Anleitungen hierzu finden Sie in der Dokumentation Ihres Receivers.

Verstärkeranforderungen - Klipsch-Lautsprecher haben einen hohen Wirkungsgrad und können mit zahlreichen Verstärkern betrieben werden. Alle Klipsch-Lautsprecher sind 8-Ohm-kompatibel und können hohe Schallpegel mit geringer Verzerrung wiedergeben. Aufgrund des hohen Ausgangspegels, den Klipsch-Lautsprecher wiedergeben können, sollten Sie den Lautstärkeregler mit Bedacht einsetzen. Übermäßige Lautstärke über längere Zeiträume hinweg kann Ihr Hörvermögen permanent schädigen. Eine Überbelastung Ihres Verstärkers kann auch die Lautsprecher beschädigen. Fragen Sie Ihren Fachhändler, ob Ihr Verstärker für Ihren Einsatzzweck geeignet ist. Wir wollen, dass Sie einen lebenslangen Hörgenuss haben.

ABBILDUNG 1
LAUTSPRECHERPLATZIERUNG IM HÖRBEREICH



ABBILDUNG 2
CENTER-KANAL



ABBILDUNG 3
STANDARDANSCHLÜSSE

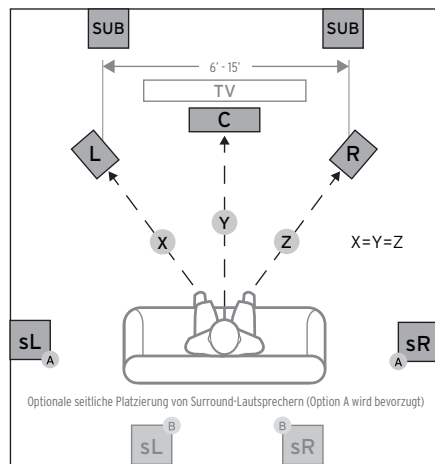

ABBILDUNG 4
WANDBEFESTIGUNG VON SURROUND-LAUTSPRECHERN

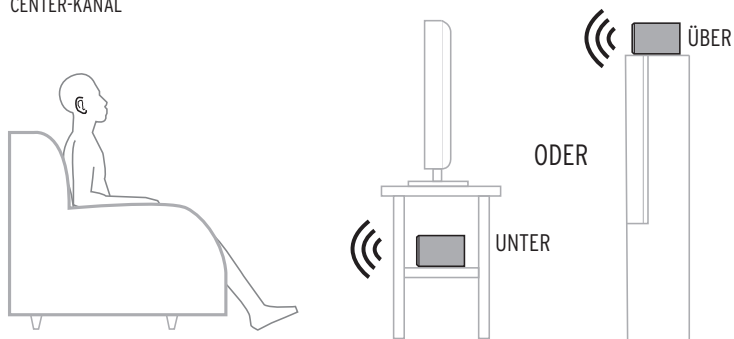

⚠ VORSICHT!
Verwenden Sie das Befestigungsloch nicht zur Deckenmontage!
Nr. 10
2.5- bis 3-Zoll Flachkopf-Holzschrauben in Ständerprofil befestigen oder Dübel verwenden - etwa 6 mm hervorstehen lassen

REFERENCE PREMIERE MIT DOLBY ATMOS® TECHNOLOGIE

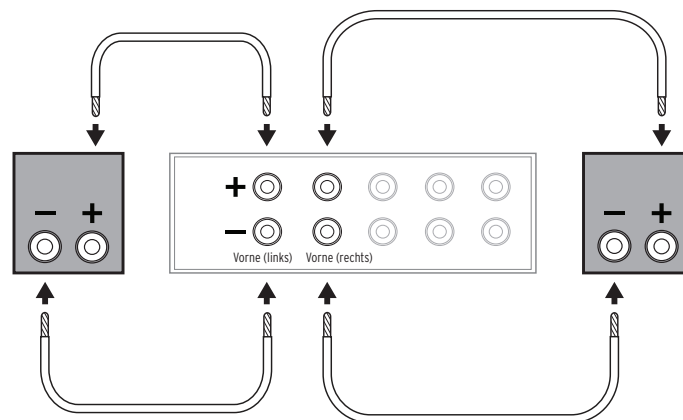
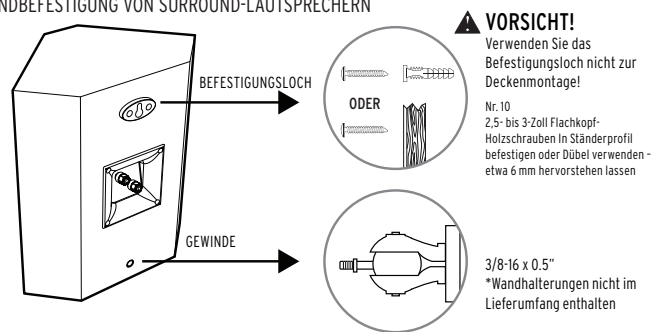
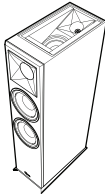

RP-8060FA

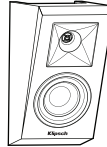

RP-500SA

- 1 ATMOS FRONT
- 2 ATMOS REAR
- 3 SIDE SURROUND
- 4 REAR SURROUND

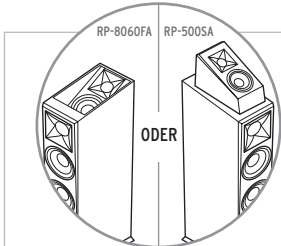

AFL AFR ARL ARR

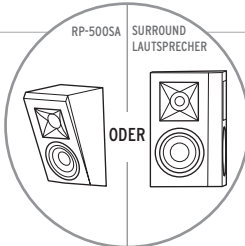

ssL ssR rsL rsR

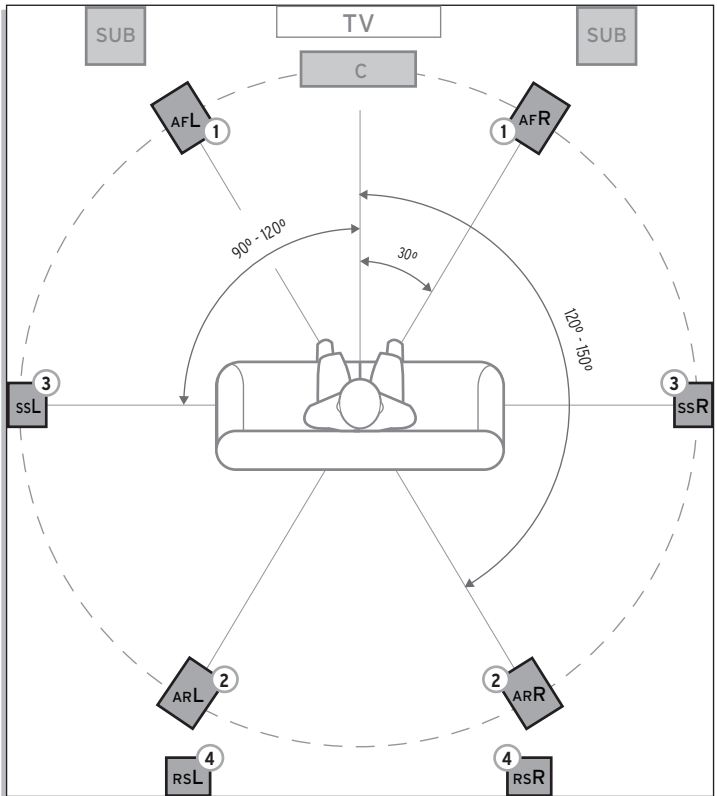
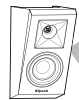

LAUTSPRECHERPLATZIERUNG IM HÖRBEREICH

REFERENCE PREMIERE MIT DOLBY ATMOS® TECHNOLOGIE

STANDARDANSCHLÜSSE

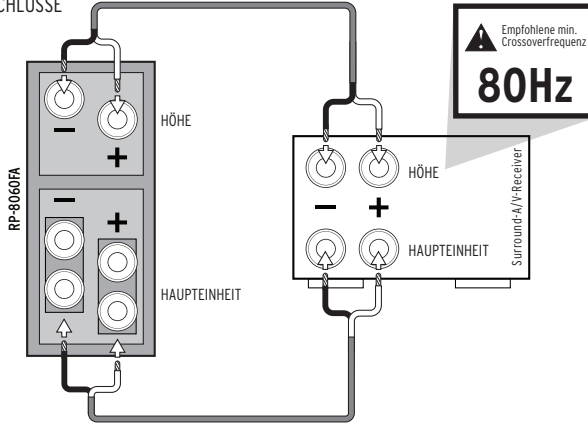

ODER

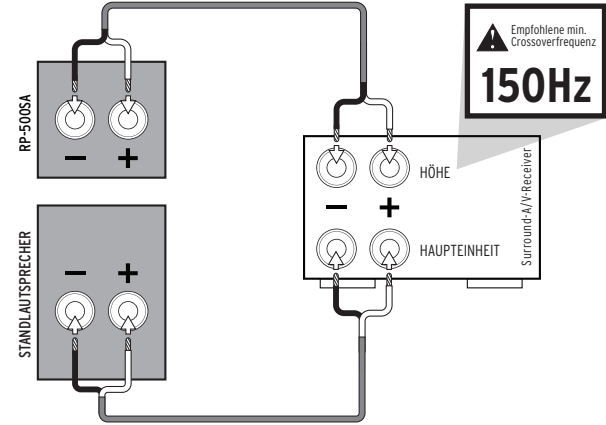

ELEVATION-LAUTSPRECHER

Der RP-500SA kann jeder Gruppe passiver Lautsprecher hinzugefügt werden.

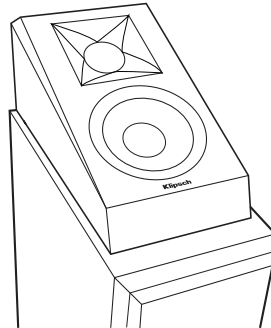

WANDBEFESTIGUNG VON SURROUND-LAUTSPRECHERN

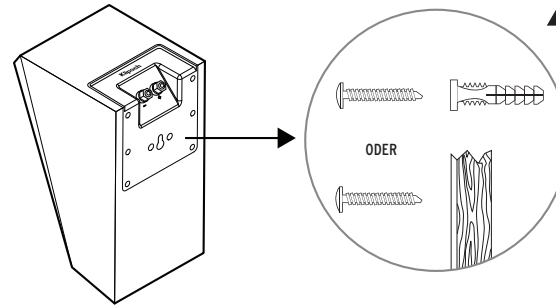

⚠ VORSICHT!
Verwenden Sie das Befestigungsloch nicht zur Deckenmontage!
Nr. 10
2,5- bis 3-Zoll Flachkopf-Holzschrauben In Ständerprofil befestigen oder Dübel verwenden - etwa 6 mm hervorstehen lassen

PFLEGE UND REINIGUNG

Die einzig nötige Pflege Ihrer Lautsprecher besteht darin, sie gelegentlich abzustauben. Verwenden Sie nie Scheuermittel, Lösungsmittel enthaltende oder aggressive Reinigungsmittel. Sie können die Lautsprechergrills mit dem Bürstenaufsatz eines Staubsaugers reinigen.

PRODUKTREGISTRIERUNG

Registrieren Sie Ihr Produkt online unter www.klipsch.com/register

- Dadurch werden Sie über neue Produkte und Sonderangebote informiert.
- Ihre personenbezogenen Daten werden nie verkauft.
- Diese Registrierungsdaten werden nicht zu Garantiezwecken verwendet.

Bewahren Sie bitte Ihre Quittung auf, um die Garantie in Anspruch nehmen zu können.

REFERENCE

ESPAÑOL

- 1) el estándar, la referencia, el punto de comparación
- 2) la encarnación del legendario sonido Klipsch

FUERTE Y ORGULLOSO DESDE 1946

En 1946, Paul W. Klipsch revolucionó la industria del audio al crear nuestra tecnología de trompeta patentada y los principios acústicos que constituyen la fuerza impulsora de nuestro altamente aclamado sonido distintivo. Hoy en día, seguimos siendo fieles a la visión de PWK y aplicamos la mayor parte de un siglo de sudor y genio a todos los productos que hacemos. Estos altavoces son el resultado de nuestras décadas de obsesión con la perfección del sonido. Sienta la potencia, el detalle y la emoción de los Reference de Klipsch.

Somos los guardianes del sonido Keepers of the Sound®.



ALTAVOCES REFERENCE PREMIERE

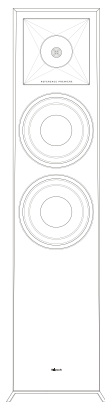

RP-8060FA

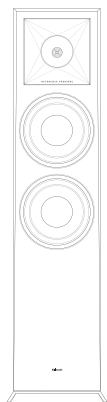

RP-8000F

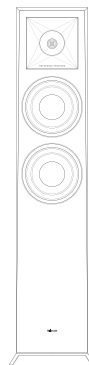

RP-6000F



RP-5000F



RP-4000F



RP-600M



RP-500M



RP-400M

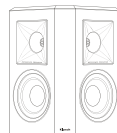

RP-502S

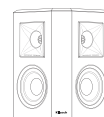

RP-402S



RP-500SA

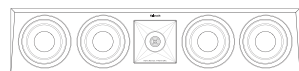

RP-504C



RP-404C

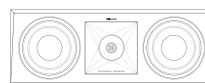

RP-600C

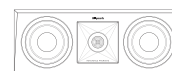

RP-500C

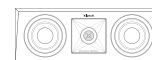

RP-400C

ANTES DE EMPEZAR

Algunos altavoces Klipsch® tienen patas y otros accesorios que puede ser necesario instalar antes de usarlos. Consulte los diagramas 1, 2, 3 y 4 para hacer la instalación.



DIAGRAMA 1
MONTAJE EN PARED



DIAGRAMA 2
CANAL CENTRAL

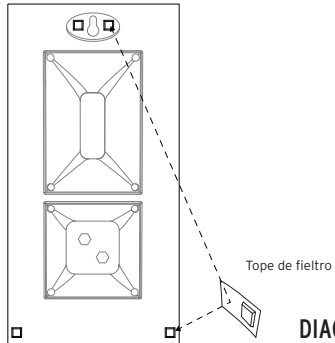

DIAGRAMA 3
ALTAVOCES SURROUND

UBICACIÓN EN LA SALA

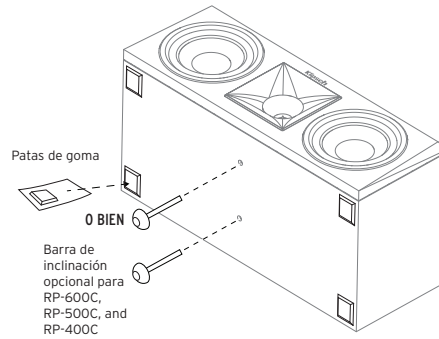
Altavoces de canal principal izquierdo y derecho. Para obtener la mejor fidelidad, Klipsch Group, Inc (KGI) sugiere separar los altavoces de 1.8 a 4.6 m (6 a 15 pies) y ubicarlos a un mínimo de 61 cm (24 plg.) de la pared de atrás y las paredes laterales. También se pueden orientar un poco hacia adentro para obtener una mejor imagen estereofónica. La posición del oyente debe estar entre 1 y 1.5 veces la distancia que separa los altavoces. En las figuras 1 y 3 hay detalles de conexión y ubicación.

Altavoces de canal central. Los altavoces de canal central han sido diseñados para ubicar el diálogo y los sonidos principales de manera que parezca que provienen de la pantalla de video. Por lo tanto, se deben ubicar lo más cerca posible de la pantalla, de preferencia directamente encima o debajo de la pantalla. En las figuras 1, 2 y 3 hay detalles de conexión y ubicación.

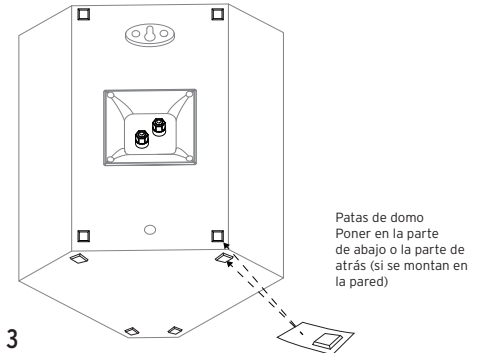
Altavoces de canal surround trasero. Los altavoces surround WDST de Klipsch deben ubicarse a una altura aproximadamente 2 pies mayor que la del oído del oyente sentado. Esto es por lo general de 5 a 7 pies sobre el piso. Los altavoces surround se pueden ubicar en las paredes directamente adyacentes o en la pared que queda detrás de la posición del oyente. La ubicación final de los altavoces surround depende de las características de la sala. Estos altavoces han sido diseñados para recrear la sensación de espacio y ambiente que proporcionan muchas de las tecnologías surround de hoy en día. En las figuras 1, 2 y 3 hay detalles de conexión y ubicación.

CONEXIONES

Conexión convencional. Con cable de altavoz calibre 16 o mayor, conecte la terminal ROJA "positiva" (+) del altavoz IZQUIERDO a la terminal ROJA "positiva" (+) del canal IZQUIERDO de su amplificador. Conecte la terminal NEGRA "negativa" (-) del altavoz IZQUIERDO a la terminal NEGRA "negativa" (-) del canal IZQUIERDO de su amplificador. Repita este procedimiento para conectar los otros altavoces a los canales correspondientes del amplificador. Consulte la figura 3. Asegúrese de que en ninguna de las conexiones haya cables sin aislamiento que toquen otras terminales, pues esto podría causar un cortocircuito y dañar el equipo.

Los modelos de Reference Premiere RP-8060FA, RP-8000F, RP-6000F, RP-5000F, RP-4000F y RP-160M tienen terminales dobles. Si se hacen conexiones de un solo cable, la barra conectora de terminal debe dejarse en posición. Si hacen conexiones de cableado doble o amplificación doble, la barra conectora de terminal debe retirarse. Hay más instrucciones en el manual del receptor.

Requisitos del amplificador. Los altavoces Klipsch son muy eficientes y funcionan bien con una extensa variedad de amplificadores. Todos los altavoces Klipsch son compatibles con 8 Ω y se pueden hacer funcionar a altos niveles con poca distorsión. Debido a los altos niveles de salida que pueden reproducir los altavoces Klipsch, tenga cuidado con el control de volumen. El volumen excesivo durante largos períodos puede dañar permanentemente el oído. Hacer funcionar el amplificador a más de su capacidad normal también puede dañar los altavoces. Consulte al minorista para asegurarse de que su amplificador es adecuado para su aplicación. Queremos que oiga toda la vida.

FIGURA 1
UBICACIÓN DEL ALTAVOZ EN EL ÁREA DE AUDICIÓN



FIGURA 2
CANAL CENTRAL



FIGURA 3
CONEXIONES ESTÁNDAR

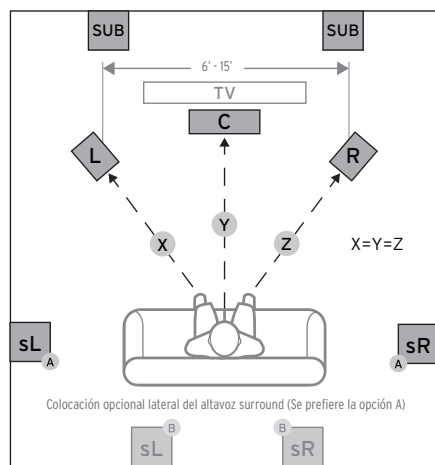

FIGURA 4
MONTAJE DE LOS ALTAVOCES SURROUND EN LA PARED

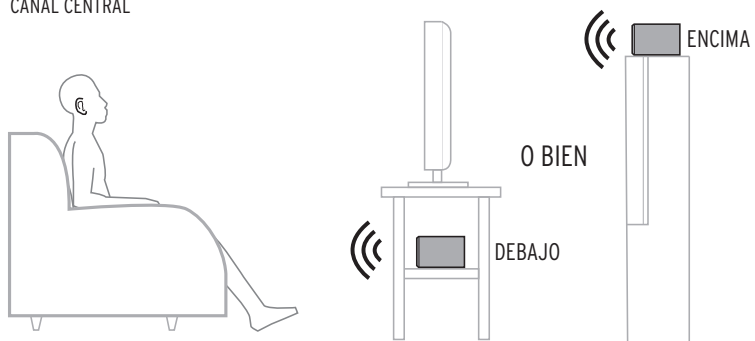

ALTAVOCES REFERENCE PREMIERE CON TECNOLOGÍA ATMOS® DE DOLBY

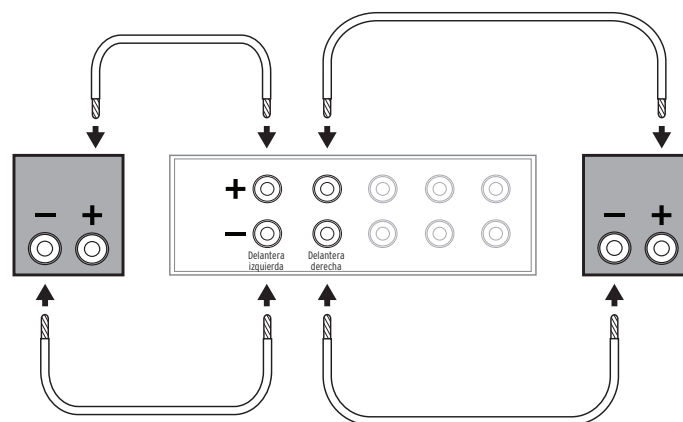
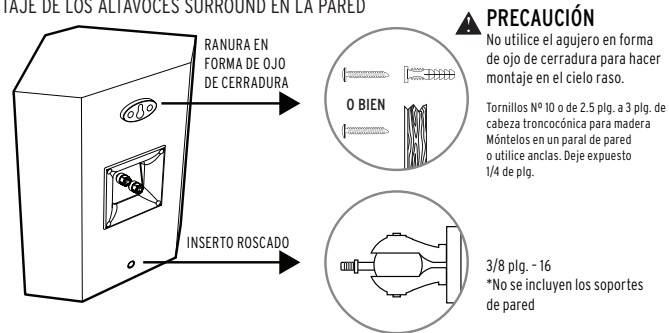
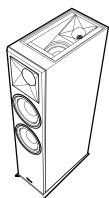

RP-8060FA

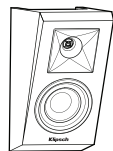

RP-500SA

- 1 ATMOS FRONT
- 2 ATMOS REAR
- 3 SIDE SURROUND
- 4 REAR SURROUND

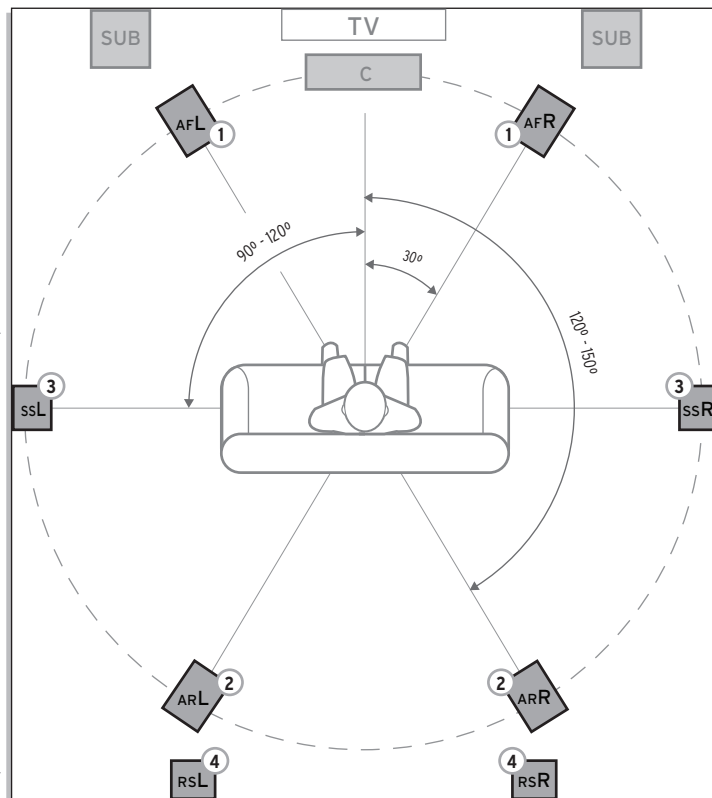
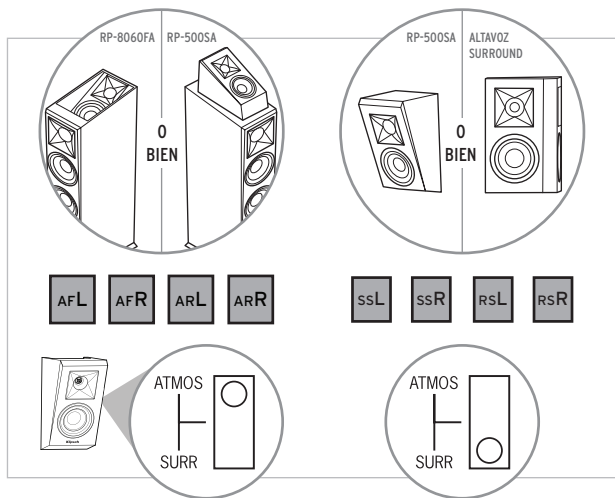

UBICACIÓN DEL ALTAVOZ EN EL ÁREA DE AUDICIÓN

ALTAVOCES REFERENCE PREMIERE CON TECNOLOGÍA ATMOS® DE DOLBY

CONEXIONES ESTÁNDAR

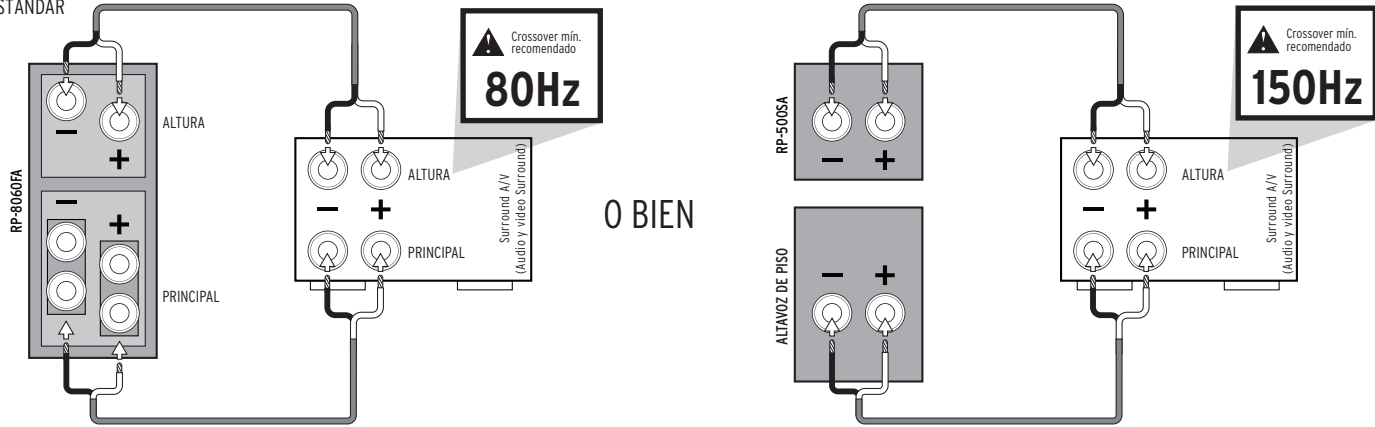

ALTAVOZ DE ALTAURA

El RP-500SA se puede agregar a cualquier configuración de altavoz pasivo.

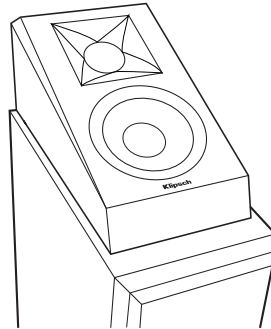

MONTAJE DE LOS ALTAVOCES SURROUND EN LA PARED

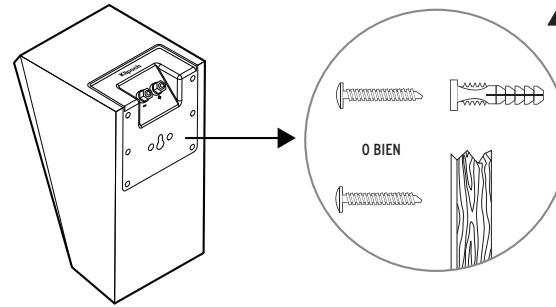

⚠ PRECAUCIÓN
 No utilice el agujero en forma de ojo de cerradura para hacer montaje en el cielo raso.
 Tornillos N° 10 o de 2.5 plg. a 3 plg. de cabeza troncocónica para madera
 Móntelos en un paral de pared o utilícelos anclas. Deje expuesto 1/4 de plg.

CUIDADO Y LIMPIEZA

Lo único que puede ser necesario hacerles a los altavoces es quitarles el polvo de vez en cuando. No les aplique nunca ni detergentes fuertes ni limpiadores abrasivos o a base de solvente. El accesorio de cepillo de su aspiradora sirve para quitarles el polvo a las rejillas de altavoz.

REGISTRO DEL PRODUCTO

Registre su producto en línea en at www.klipsch.com/register

- Manténgase al día sobre nuevos productos y promociones.
- Sus datos personales nunca serán vendidos.
- Estos datos de registro no son para propósitos de garantía.

Guarde su recibo para hacer reclamaciones de garantía.

REFERENCE

PORTUGUÊS

1) o padrão, o parâmetro, o ponto utilizado para comparação

2) a personificação do lendário som Klipsch

ORGULHO DESDE 1946

Em 1946, Paul W. Klipsch revolucionou a indústria de áudio criando nossa exclusiva tecnologia de cornetas patenteada e os princípios acústicos que são a força por trás de nosso aclamado som singular. Hoje, continuamos a ser fiéis à visão de Paul W. Klipsch e colocamos em cada produto que fabricamos o melhor de um século de suor e genialidade. Essas caixas acústicas são o resultado da nossa longa obsessão com a perfeição sonora. Sinta a potência, a fidelidade sonora e a emoção da linha Klipsch Reference.

Somos os Keepers of the Sound®.



CAIXAS ACÚSTICAS REFERENCE PREMIERE

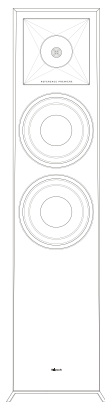

RP-8060FA

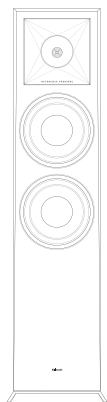

RP-8000F

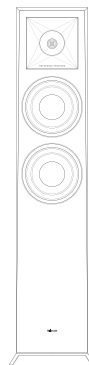

RP-6000F



RP-5000F



RP-4000F



RP-600M



RP-500M



RP-400M

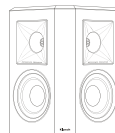

RP-502S

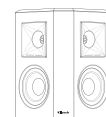

RP-402S



RP-500SA



RP-504C



RP-404C

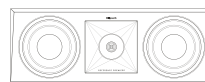

RP-600C



RP-500C

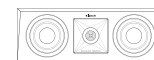

RP-400C

ANTES DE COMEÇAR

Algumas caixas acústicas Klipsch® têm bases e outros acessórios que podem necessitar de instalação antes de serem usadas. Para instalação, consulte os diagramas 1, 2, 3 e 4.

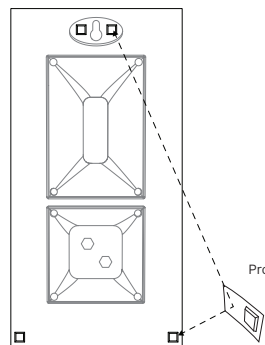

Protetor de feltro

DIAGRAMA 1
MONTAGEM NA
PAREDE

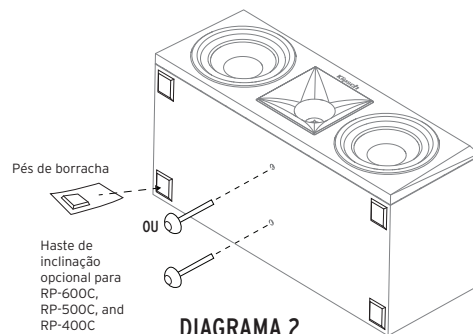

Pés de borracha

Haste de inclinação
opcional para
RP-600C,
RP-500C, and
RP-400C

DIAGRAMA 2
CANAL CENTRAL

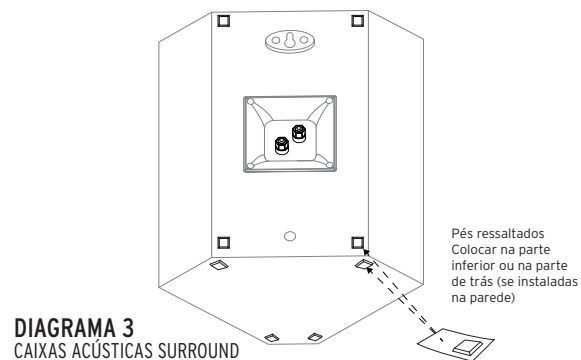

Pés ressaltados
Colocar na parte
inferior ou na parte
de trás (se instaladas
na parede)

DIAGRAMA 3
CAIXAS ACÚSTICAS SURROUND

POSICIONAMENTO NO AMBIENTE

Caixas acústicas direita e esquerda do canal principal – Para máximo desempenho, a Klipsch Group, Inc. (KGI) sugere posicionar as caixas acústicas de 1,8 a 4,6 m de distância entre si e no mínimo 61 cm afastadas das paredes laterais e traseira. Elas também podem ser posicionadas em ângulo, com os planos frontais ligeiramente voltados entre si para melhor fidelidade na reprodução estéreo. A posição de audição deve ser aproximadamente uma a uma vez e meia a distância que separa as caixas acústicas. Consulte as figuras 1 e 3. Elas ilustram aspectos da conexão e posicionamento das unidades.

Caixas acústicas do canal central – As caixas acústicas do canal central foram projetadas para reproduzir diálogos e sons primários de modo que pareçam se originar da tela de vídeo. Devem, portanto, ser posicionadas o mais próximo possível da tela, de preferência diretamente em cima ou embaixo da tela. Consulte as figuras 1, 2 e 3. Elas ilustram aspectos da conexão e posicionamento das unidades.

Caixas acústicas traseiras do canal surround – As caixas acústicas surround Klipsch W DST devem ser colocadas a aproximadamente 60 cm acima da posição ocupada pelo ouvinte, normalmente, cerca de 1,5 a 2 m acima do chão. As caixas acústicas surround devem ser colocadas nas paredes diretamente adjacentes à posição ocupada pelo ouvinte. Outra opção é uma parede atrás da posição ocupada pelo ouvinte. A posição final das caixas acústicas surround depende das características do ambiente. Elas foram projetadas para recriar a sensação de espaço e atmosfera proporcionada por muitas das tecnologias de som surround atuais. Consulte as figuras 1, 3 e 4. Elas ilustram aspectos da conexão e posicionamento das unidades.

CONEXÃO

Conexão convencional – Usando um cabo para caixa acústica bitola 16 AWG ou maior, conecte o terminal “positivo” (+) VERMELHO da caixa acústica ESQUERDA ao terminal “positivo” (+) VERMELHO do canal ESQUERDO do amplificador. Conecte o terminal “negativo” (-) PRETO da caixa acústica ESQUERDA ao terminal “negativo” (-) PRETO do canal ESQUERDO do amplificador. Repita este procedimento para conectar todas as demais caixas acústicas aos canais apropriados no amplificador. Consulte a Figura 3. Certifique-se de que nenhum fio exposto de qualquer uma das conexões toque em qualquer um dos demais terminais, já que poderá causar curto-circuito e danificar o equipamento.

Os modelos RP-8060FA, RP-8000F, RP-6000F, RP-5000F, RP-4000F e RP-160M do Reference Premiere estão equipados com terminais de conexão duplos. Se uma conexão de um só cabo for usada, a barra de conexão do terminal deve ficar instalada. Se uma conexão com dois cabos ou dois amplificadores for usada, a barra de conexão do terminal deve ser removida. Consulte o manual do receiver para obter mais instruções.

Requisitos do amplificador – As caixas acústicas Klipsch são altamente eficientes e funcionarão bem com uma grande variedade de amplificadores. Todas as caixas acústicas Klipsch são compatíveis com 8 Ω e podem ser excitadas até a níveis muito elevados com pouca distorção. Devido aos altos níveis de potência das caixas acústicas Klipsch, recomendamos cuidado ao ajustar o controle de volume. Um volume ajustado a um nível muito alto por longos períodos de tempo pode causar danos permanentes à audição. Usar o amplificador com nível excessivo de potência também pode danificar as caixas acústicas. Consulte o revendedor para confirmar se o amplificador utilizado é a melhor opção para sua aplicação. Nosso desejo é que você desfrute dos prazeres do som por toda a vida.

FIGURA 1
POSICIONAMENTO DAS CAIXAS ACÚSTICAS NO AMBIENTE



FIGURA 2
CANAL CENTRAL



FIGURA 3
CONEXÕES PADRÃO

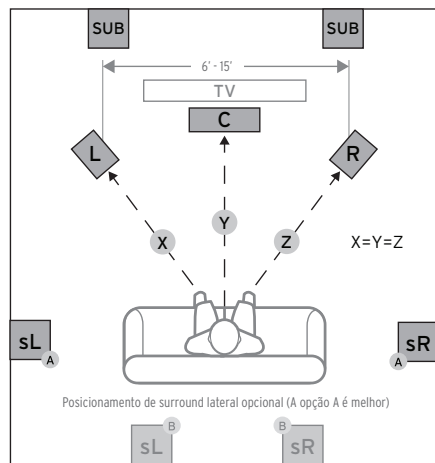

FIGURA 4
INSTALAÇÃO DAS CAIXAS ACÚSTICAS SURROUND EM PAREDE

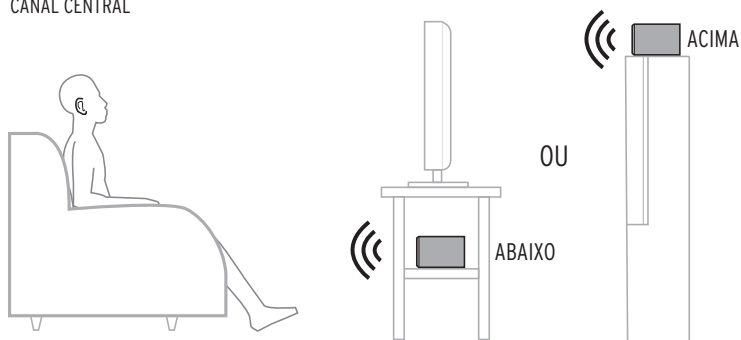

REFERENCE PREMIERE COM TECNOLOGIA DOLBY ATMOS®

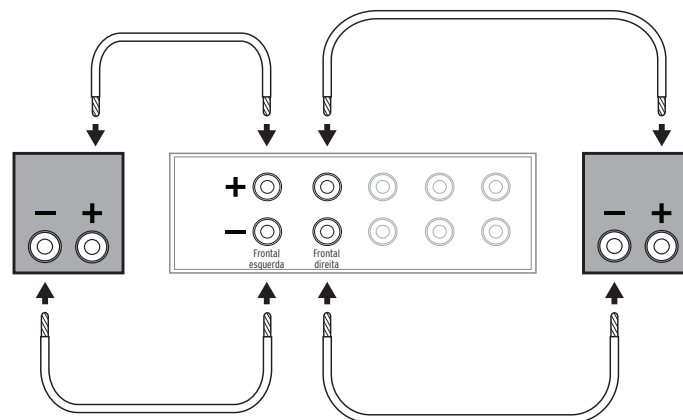
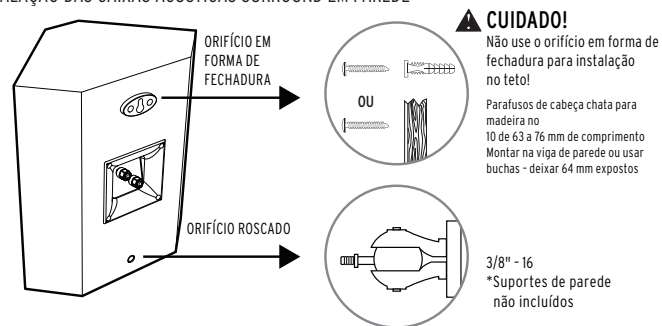
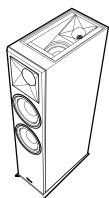

RP-8060FA

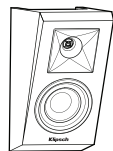

RP-500SA

- 1 ATMOS FRONT
- 2 ATMOS REAR
- 3 SIDE SURROUND
- 4 REAR SURROUND

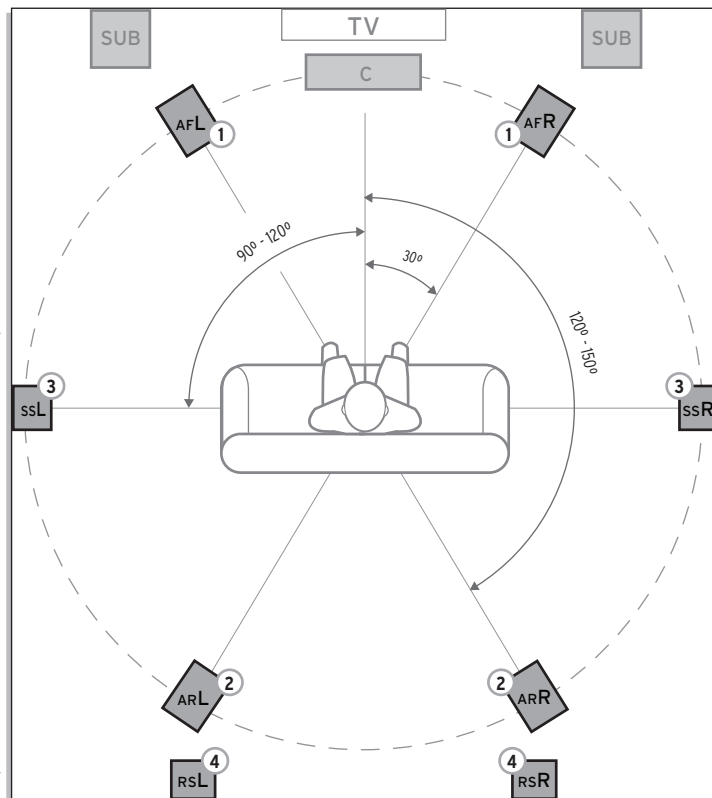
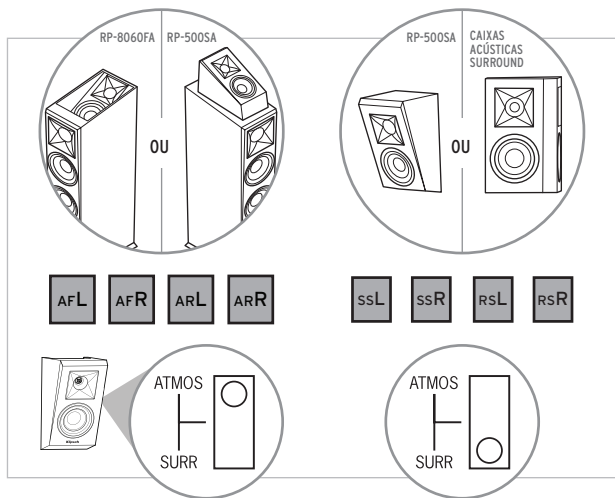

POSICIONAMENTO DAS CAIXAS ACÚSTICAS NO AMBIENTE

REFERENCE PREMIERE COM TECNOLOGIA DOLBY ATMOS®

CONEXÕES

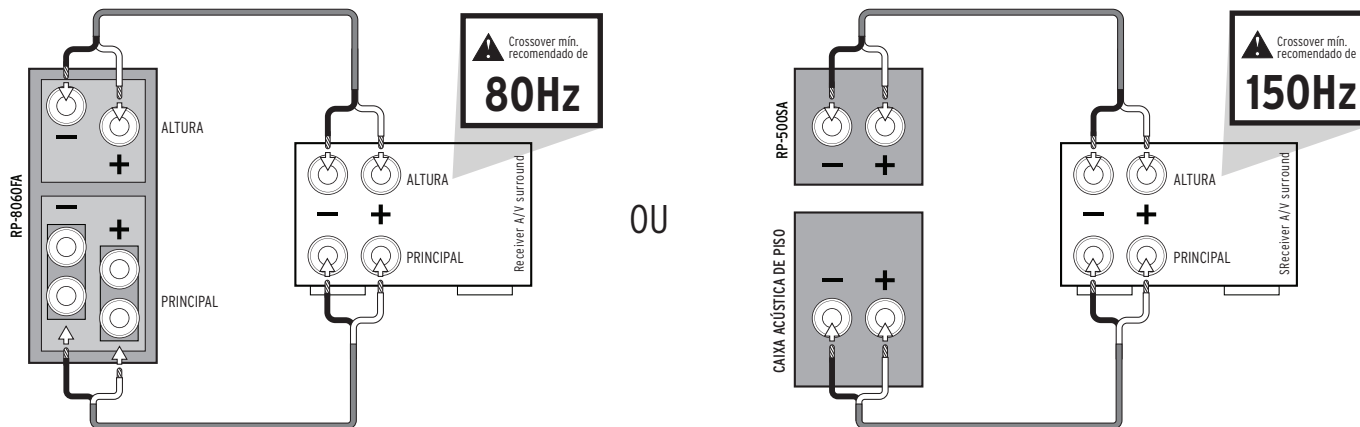

CAIXAS ACÚSTICAS DE ELEVAÇÃO

A RP-500SA pode ser adicionada a qualquer configuração de caixa acústica passiva.

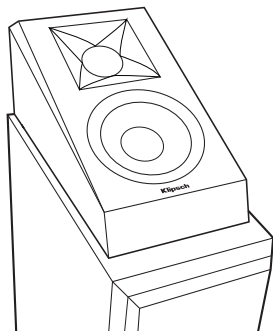

INSTALAÇÃO DAS CAIXAS ACÚSTICAS SURROUND EM PAREDE

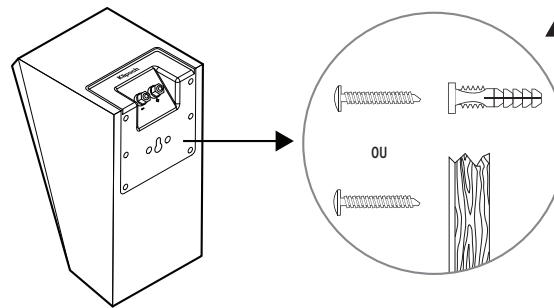

⚠ CUIDADO!
Não use o orifício em forma de fechadura para instalação no teto!
Parafusos de cabeça chata para madeira no 10 de 63 a 76 mm de comprimento
Montar na viga de parede ou usar buchas - deixar 64 mm expostos

CUIDADO E LIMPEZA

O cuidado das caixas acústicas só requer a remoção periódica do pó acumulado nas superfícies. Nunca use qualquer tipo de produto de limpeza abrasivo ou à base de solventes, nem qualquer detergente forte. As grades podem ser limpas com a escova de um aspirador de pó.

REGISTRO DO PRODUTO

Registre o produto on-line no site www.klipsch.com/register.

- Mantenha-se atualizado sobre novos produtos e promoções.
- Suas informações pessoais nunca serão vendidas a terceiros.
- As informações solicitadas para registro do produto não são usadas para fins de garantia.

Guarde uma cópia da nota fiscal ou recibo como comprovante para serviços cobertos pela garantia.

REFERENCE

ITALIANO

- 1) standard, parametro, punto utilizzato per un confronto
- 2) l'espressione perfetta del leggendario suono Klipsch

UN SUONO STRAORDINARIO SIN DAL 1946

Nel 1946, Paul W. Klipsch rivoluzionò il settore degli impianti audio creando la nostra tecnologia brevettata del caricamento a tromba e le tecniche dell'acustica che sono alla base del nostro rinomato suono senza pari. Oggi, rimaniamo coerenti con la visione di PWK e incorporiamo la parte migliore di un secolo di impegno e genio in ogni prodotto che realizziamo. Questi altoparlanti sono il risultato della nostra passione, che dura da decenni, per la perfezione acustica. Provate la potenza, i dettagli audio e le emozioni offerte da Klipsch Reference.

Siamo i custodi del suono: Keepers of the Sound®.



ALTOPARLANTI REFERENCE PREMIERE

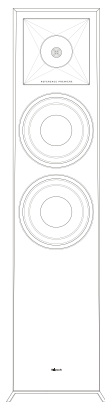

RP-8060FA

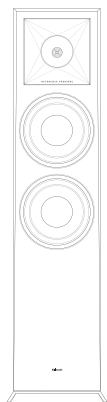

RP-8000F

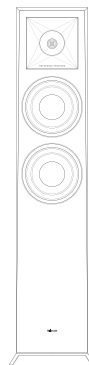

RP-6000F



RP-5000F



RP-4000F



RP-600M



RP-500M



RP-400M

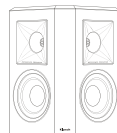

RP-502S

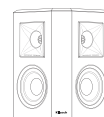

RP-402S



RP-500SA

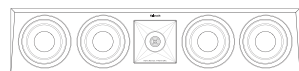

RP-504C



RP-404C

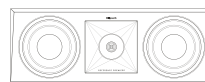

RP-600C

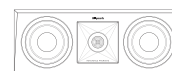

RP-500C

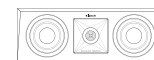

RP-400C

OPERAZIONI PRELIMINARI

Alcuni altoparlanti Klipsch® sono dotati di piedini e altri accessori che potrebbe essere necessario installare prima dell'uso. Vedere le figure 1, 2, 3 e 4 per l'installazione.

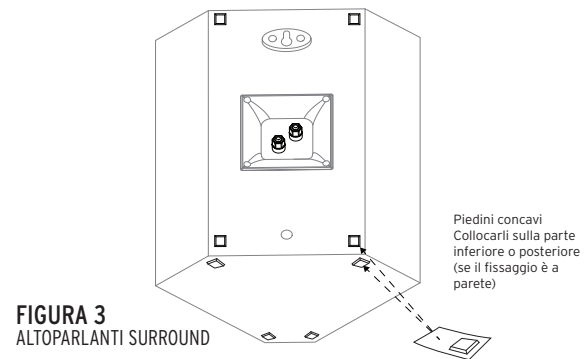
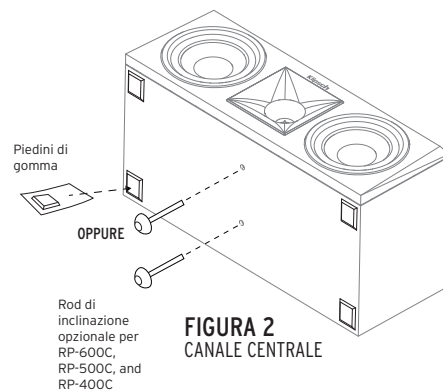
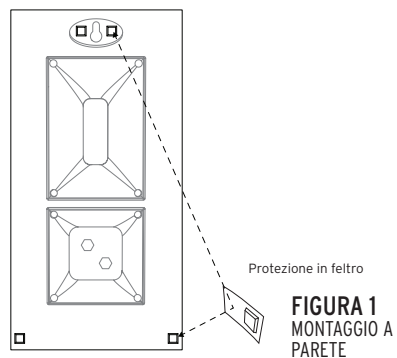

COLLOCAZIONE NELLA SALA

Altoparlanti sinistro e destro del canale principale - Per ottenere prestazioni ottimali, Klipsch Group, Inc. (KGI) suggerisce di collocare gli altoparlanti a una distanza compresa tra 1,8 e 4,6 metri l'uno dall'altro e ad almeno 61 centimetri di distanza dalle pareti posteriore e laterali. Inoltre gli altoparlanti possono essere angolati leggermente verso l'interno per ottenere un'immagine stereo migliore. La distanza di ascolto deve essere pari a circa 1 - 1,5 volte la distanza di separazione tra gli altoparlanti. Vedere le figure 1 e 3 per le connessioni e la collocazione.

Altoparlanti del canale centrale - Sono progettati per riprodurre l'audio in modo che i dialoghi e i suoni principali sembrano provenire dallo schermo, quindi devono essere collocati quanto più possibile vicino allo schermo stesso, se possibile direttamente sopra o sotto di esso. Vedere le figure 1, 2 e 3 per le connessioni e la collocazione.

Altoparlanti posteriori del canale surround - I Klipsch WDST devono essere collocati a circa 62 centimetri sopra la posizione di ascolto, che in genere è a circa 1,5 - 2,1 metri di altezza dal pavimento. Gli altoparlanti surround devono essere fissati alle pareti, adiacenti direttamente alla posizione di ascolto. Un'altra scelta sarebbe il fissaggio alla parete dietro la posizione di ascolto. La collocazione finale degli altoparlanti surround dipende dalle caratteristiche della sala, poiché sono progettati per ricreare il senso di spazio e atmosfera offerto da molte delle attuali tecnologie del suono surround. Vedere le figure 1, 3 e 4 per le connessioni e la collocazione.

COLLEGAMENTO

Collegamento tipico - Usando cavi di potenza di sezione uguale o maggiore di 1,30 mm² (16 AWG), collegare il terminale "positivo" (+) ROSSO e il terminale "negativo" NERO dell'altoparlante SINISTRO rispettivamente ai terminali "positivo" (+) ROSSO e "negativo" NERO del canale SINISTRO dell'amplificatore. Procedere in questo modo per collegare tutti gli altri altoparlanti ai corrispondenti canali dell'amplificatore. Vedere la Figura 3. Accertarsi che nessun conduttore nudo di una connessione tocchi qualunque altro terminale, altrimenti si potrebbe causare un cortocircuito e danni all'impianto.

I modelli Reference Premiere RP-8060FA, RP-8000F, RP-6000F, RP-5000F, RP-4000F e RP-160M sono dotati di terminali doppi. Se si eseguirà una connessione a singolo cavo, la barra di collegamento dei terminali deve rimanere inserita, mentre va rimossa se si eseguirà un cablaggio doppio o a bi-amplificazione. Consultare il manuale del ricevitore per ulteriori istruzioni.

Requisiti sull'amplificatore - Grazie alla loro alta efficienza, gli altoparlanti Klipsch funzionano facilmente con un'ampia gamma di amplificatori. Tutti gli altoparlanti Klipsch sono adattati a 8 ohm e possono essere pilotati a livelli molto alti con bassa distorsione. Poiché questi altoparlanti sono in grado di riprodurre livelli di uscita elevati, procedere con cautela quando si aumenta il volume; l'esposizione prolungata a volumi eccessivi può danneggiare l'udito in modo permanente. Anche il sovrapiotaggio dell'amplificatore potrebbe danneggiare gli altoparlanti. Rivolgersi al rivenditore per accertarsi che l'amplificatore che si desidera usare sia adatto all'applicazione prevista al fine di ottenere i migliori risultati dai nostri altoparlanti.

FIGURA 1
COLLOCAZIONE DEGLI ALTOPARLANTI NELL'AREA DI ASCOLTO



FIGURA 2
CANALE CENTRALE



FIGURA 3
CONNESSIONI STANDARD

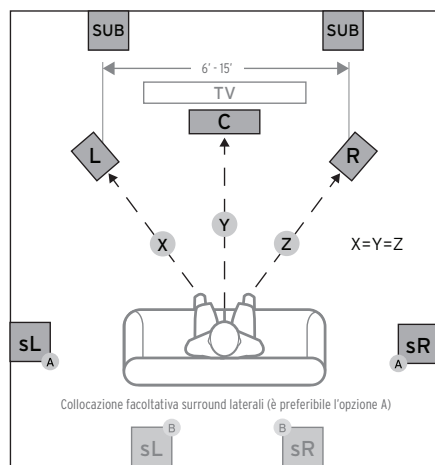

FIGURA 4
FISSAGGIO A PARETE DEGLI ALTOPARLANTI SURROUND

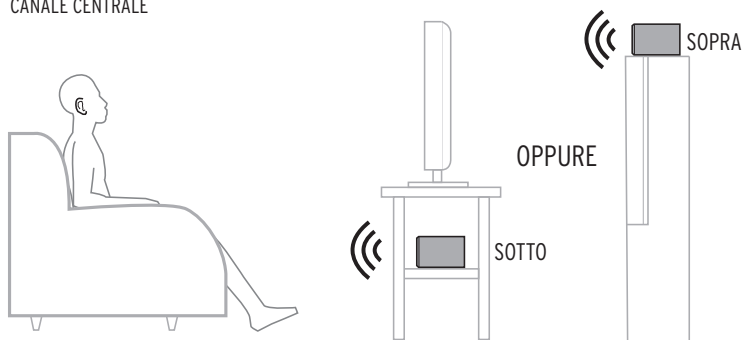

REFERENCE PREMIERE CON TECNOLOGIA DOLBY ATMOS®

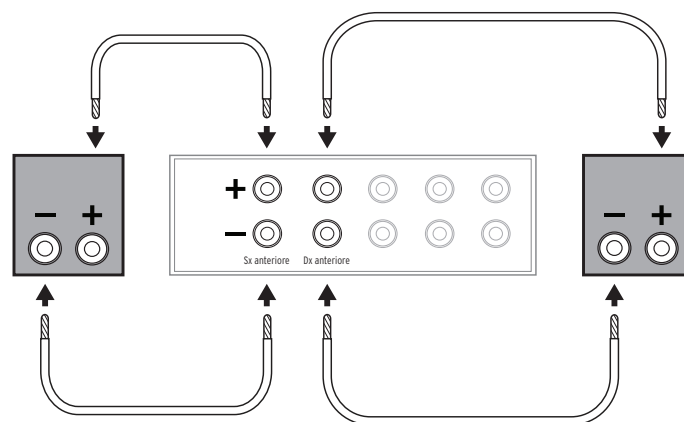
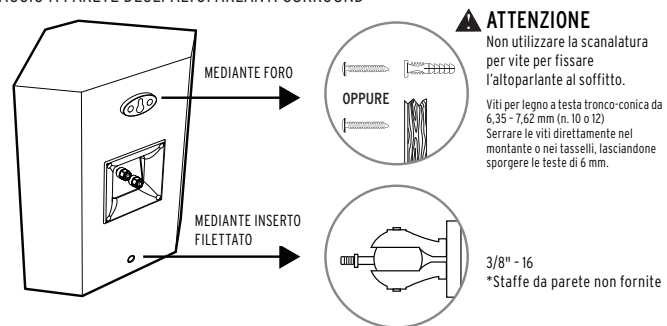
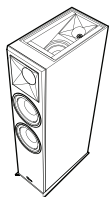

RP-8060FA

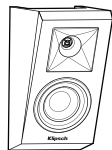

RP-500SA

- 1 ATMOS FRONT
- 2 ATMOS REAR
- 3 SIDE SURROUND
- 4 REAR SURROUND

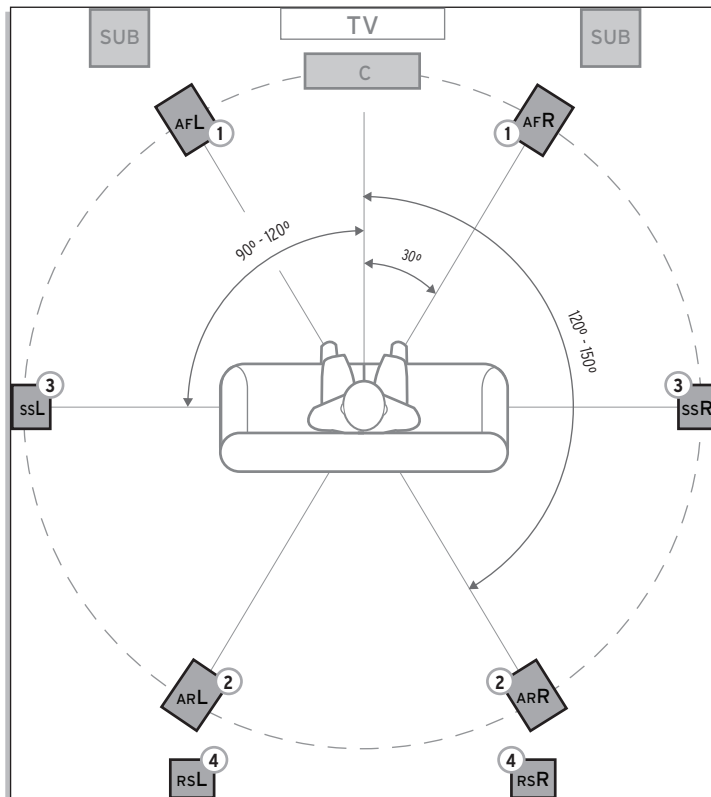
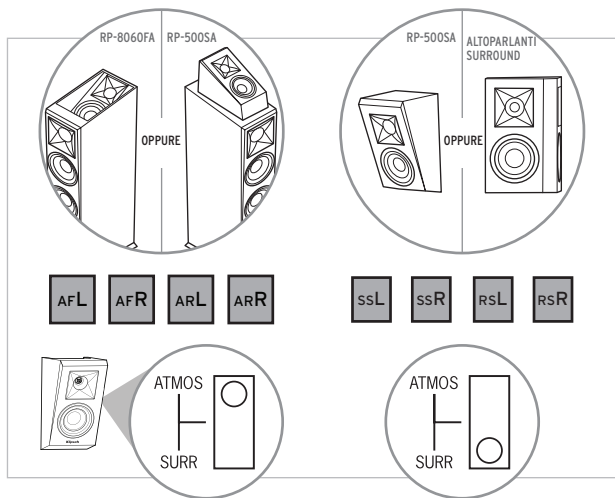

COLLOCAZIONE DEGLI ALTOPARLANTI NELL'AREA DI ASCOLTO

REFERENCE PREMIERE CON TECNOLOGIA DOLBY ATMOS®

CONNESSIONI

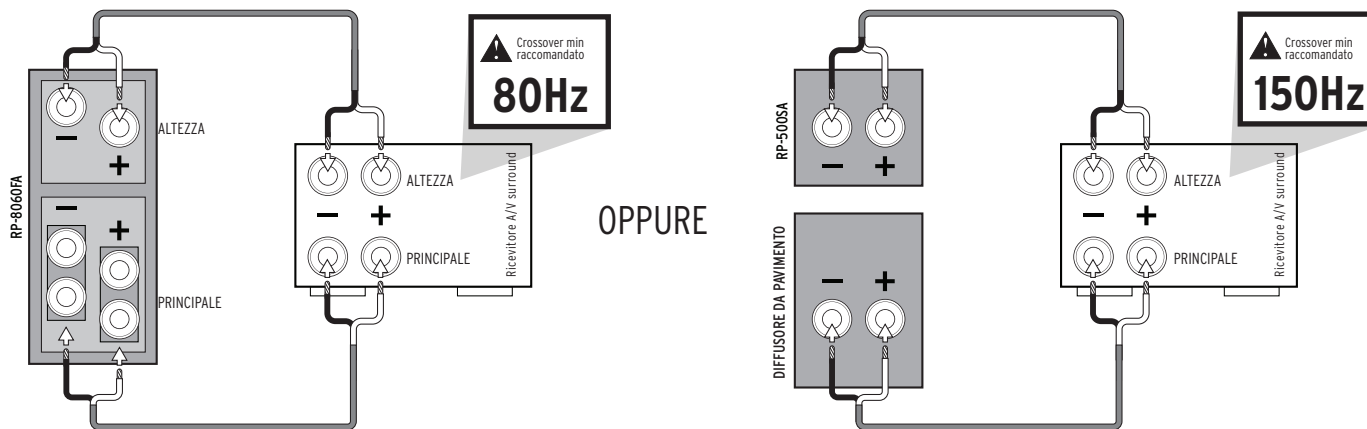

ALTOPARLANTI ELEVATO

L'RP-500SA può essere aggiunto a qualsiasi configurazione di altoparlanti passivi.

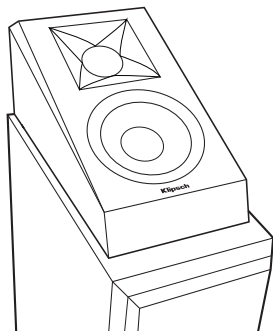

FISSAGGIO A PARETE DEGLI ALTOPARLANTI SURROUND

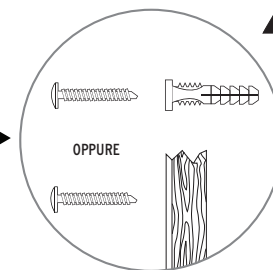
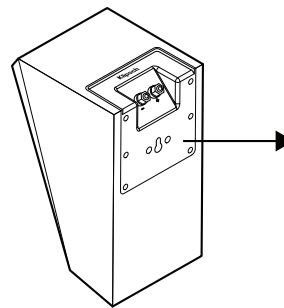

ATTENZIONE

Non utilizzare la scanalatura per vite per fissare l'altoparlante al soffitto.

Viti per legno a testa tronco-conica da 6,35 - 7,62 mm (n. 10 o 12)
Serrare le viti direttamente nel montante o nei tasselli, lasciandone sporgere le teste di 6 mm.

CURA E PULIZIA

Per pulire gli altoparlanti basta spolverarli di tanto in tanto. Non applicare mai abrasivi o detergenti forti o a base di solvente. Le griglie possono essere pulite con l'accessorio a spazzola di un aspirapolvere.

REGISTRO DO PRODUTO

Il prodotto può essere registrato on-line sul sito www.klipsch.com/register

- Si riceveranno così informazioni su nuovi prodotti e promozioni.
- I dati personali degli utenti non saranno mai venduti.
- Le informazioni di registrazione non vengono utilizzate a scopi di garanzia.

Conservare la ricevuta per mostrarla in caso di reclami coperti dalla garanzia.

杰士参考系列音箱

- 1) 标准、基准、比较点
- 2) 展现传奇的杰士音响

1946年以来的宏亮与自豪

1946年，保罗·克里普什 (Paul W. Klipsch) 凭借所创立的专有扬声技术和对声学原理的理解，彻底改变了音响行业，成就了广受世人赞誉的标志性音响声音。如今，我们仍然忠实于保罗的理念，继承公司近一个世纪以来努力和智慧的结晶，将其精华融入公司的每件音响产品。这些产品体现了我们几十年来对完美听觉艺术的痴迷和追求。请亲身体验杰士参考系列音响所再现的强劲、细腻且富有情感的声音。

我们是Keepers of the Sound®。



参考系列扬声器



RP-8060FA

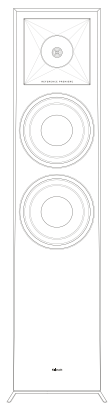

RP-8000F



RP-6000F



RP-5000F

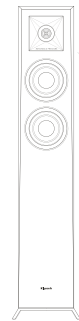

RP-4000F



RP-600M



RP-500M



RP-400M

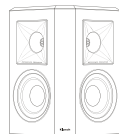

RP-502S

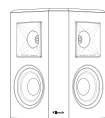

RP-402S



RP-500SA



RP-504C

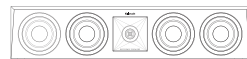

RP-404C

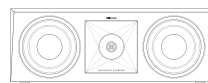

RP-600C

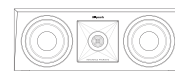

RP-500C

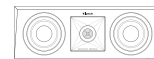

RP-400C

开始使用之前

有些杰士音箱配有脚垫和其它附件，需要在使用前进行安装。请参照图1A 1B, 2, 3和4进行安装。



图1
壁挂式安装



图2
中间声道

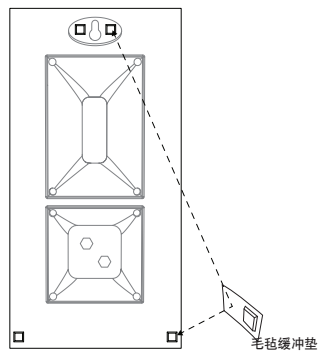

图3
环绕立体声音箱

圆顶垫
放置在底部或背面（若进行
壁挂安装）

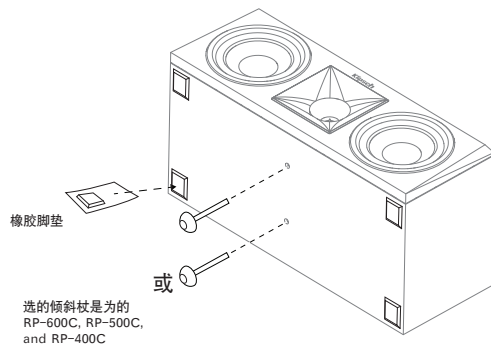
室内音箱的布放

左、右主声道音箱：为了获得最佳效果，杰士集团有限公司（KGI）建议您把音箱分开6到15英尺（1.8-4.6米）放置。另外，音箱与后墙和侧墙的距离要保持至少24英寸（61厘米）。两个音箱可稍微内倾，这样可以更好地再现立体声效果。收听者与音箱的距离应该是两扬声器间距的约1至1.5倍。请参见图1和图3进行音箱连接和放置。

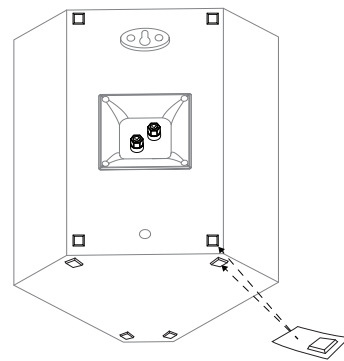
中声道音箱：根据设计，中声道音箱是为了再现对话和基本声音，并使这些声音听上去是来自视频画面的声音。因此中声道扬声器应尽可能靠近屏幕放置，最好直接放置在画面上方或下方。请参考图1、图2和图3进行中声道音箱的连接和放置。

后置环绕立体声音箱：杰士WDST环绕立体声音箱应放置在比听者高约2英尺（0.6米）的位置。该位置一般高于地板约5-7英尺（1.5-2.1米）。环绕立体声音箱应放在直接毗邻聆听位置的各墙壁上，或放置在聆听位置后面的墙壁上。环绕立体声音箱的最终放置位置取决于您房间的特点。根据设计，环绕立体声音箱用来再现如今许多环绕立体声技术所提供的声音的空间感和氛围感。请参考图1、图3和图4来连接和放置环绕立体声音箱。请注意，环绕立体声音箱的面网是固定的，因此无法被取下。

电气连接

传统连接方式：请使用16号（16-gauge）或更粗的喇叭线，把左音箱的正极端子（红色端子）连接到放大器的左声道正极端子（红色端子），将左音箱的负极端子（黑色端子）连接到放大器的左声道负极端子（黑色端子）。重复此步骤，将其余所有音箱连接到相应的放大器声道上。请参考图3。每个端子连接上若有裸线，则该裸线不得触及任何其他端子，否则可能造成短路并损坏设备。

Reference Premiere RP-8060FA, RP-8000F, RP-6000F, RP-5000F, RP-4000F 和 RP-160M 型音箱均配备双接线柱。如果采用单导线连接，终端连接条应留在原位。如果采用“双导线”或“双放大器”连接，则必须将终端连接条移除。请参阅接收器手册中的进一步说明。

对放大器的要求：杰士音箱放音效率很高，可以轻松配合多种放大器使用。所有杰士扬声器均兼容8欧姆阻抗，可以播放的音量很大，而声音失真却很小。由于音箱能再现大音量，所以调整音量时请务必审慎行事。长期播放过大的音量可能会永久损害您的听力。放大器输出过大也会损坏扬声器。请与经销商联系，确认您要使用的放大器是否完美匹配您的音响系统和环境。希望杰士音箱陪伴您一生。

图1
在聆听区域放置扬声器



图2
中间声道



图3
标准连接

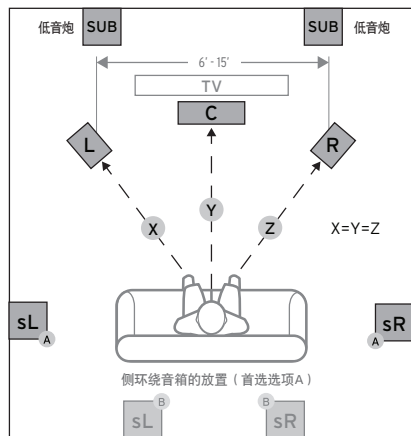

图4
墙面安装环绕音箱

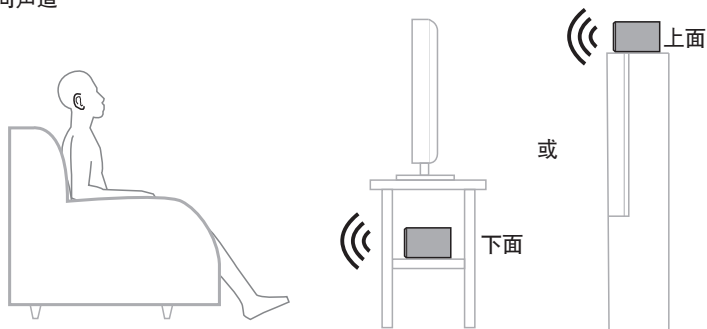

采用 DOLBY ATMOS® 技术的 REFERENCE PREMIERE 系列音箱

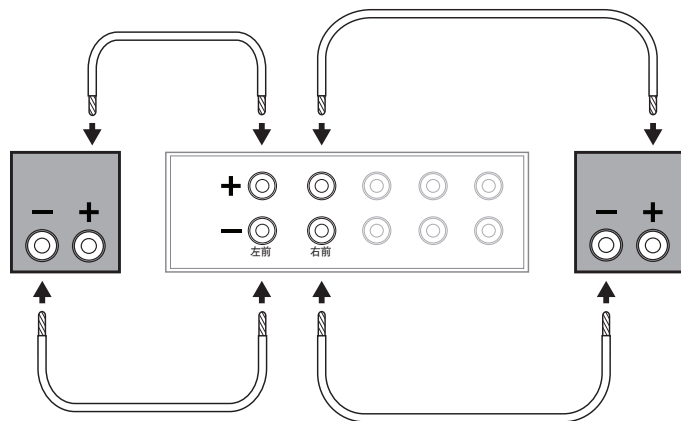
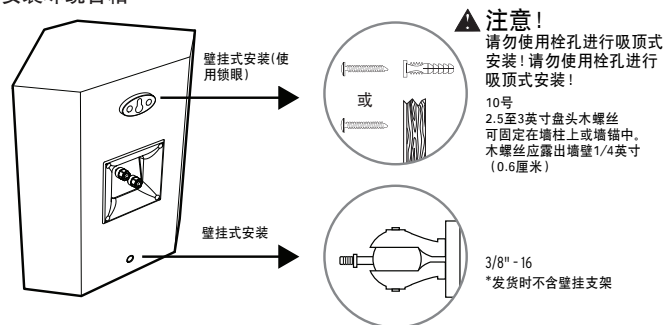
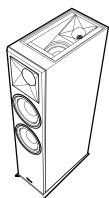

RP-8060FA

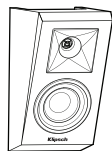

RP-500SA

- 1 ATMOS FRONT
- 2 ATMOS REAR
- 3 SIDE SURROUND
- 4 REAR SURROUND

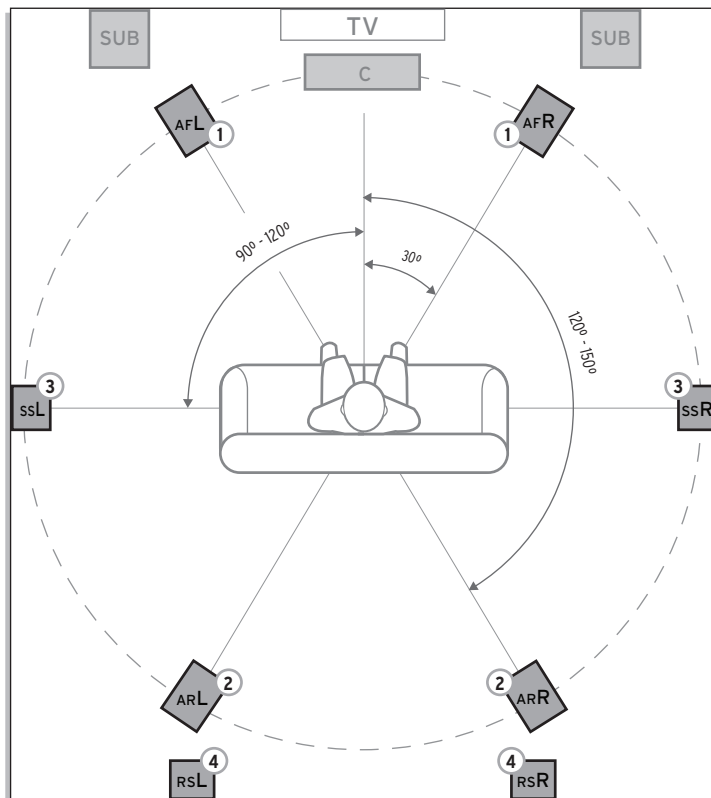
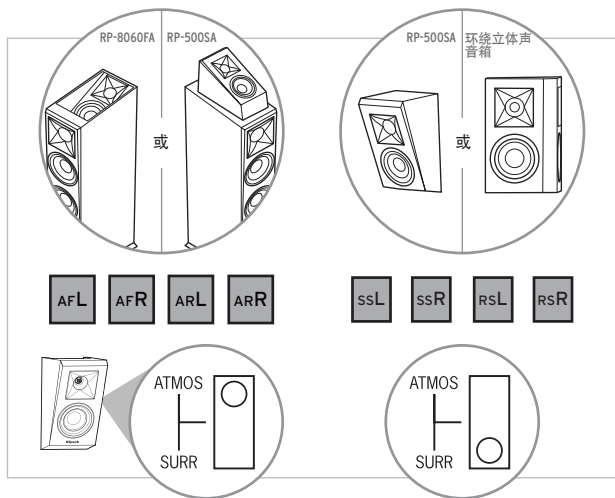

在聆听区域放置扬声器

采用 DOLBY ATMOS® 技术的 REFERENCE PREMIERE 系列音箱

标准连接

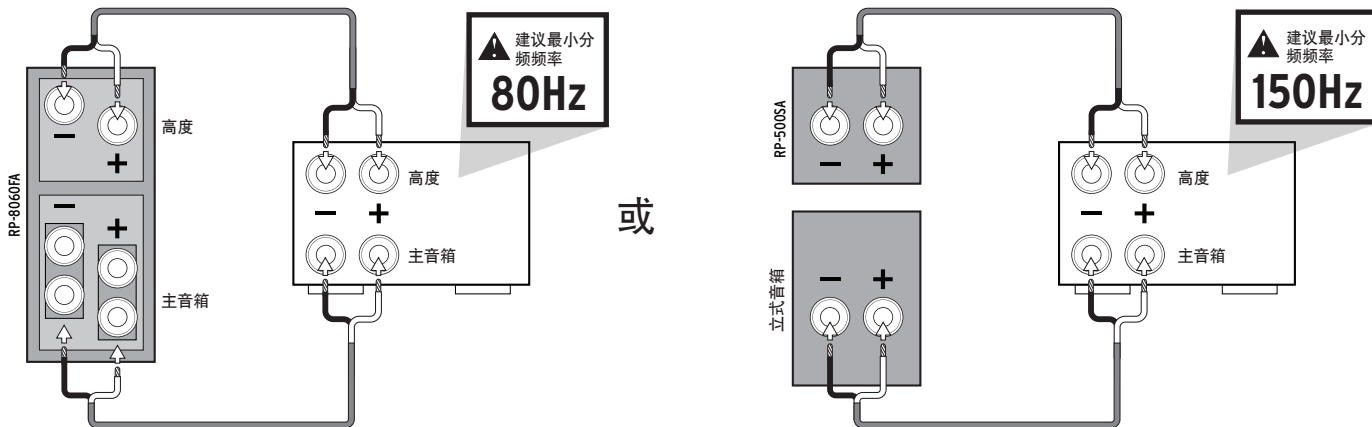

仰角声道

可将 RP-500SA 添加至任何无源扬声器设置中。

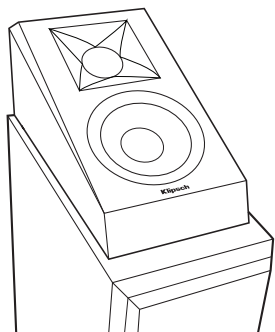

墙面安装环绕音箱

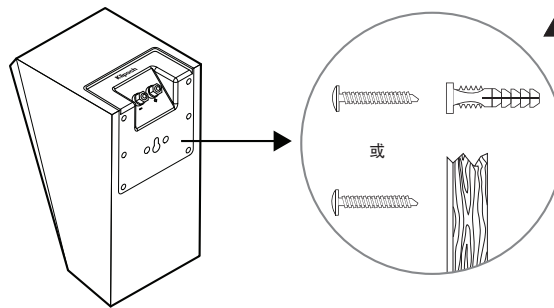

注意!
请勿使用栓孔进行吸顶式安装! 请勿使用栓孔进行吸顶式安装!
10号
2.5至3英寸盘头木螺丝
可固定在墙柱上或墙柱中,
木螺丝应露出墙壁1/4英寸
(0.6厘米)

保养和清洁

您需要做的只是偶尔掸去音箱的灰尘。不要使用任何摩擦性或溶解性清洁剂以及任何粗糙的去污剂。可以使用吸尘器配备的刷子来清洁面网。

产品注册

请在www.klipsch.com/register在线注册您的产品

- 了解最新产品促销活动。
- 您的个人信息绝不会被转售。
- 该注册信息不用于保修目的。

请保存好您的收据，保修时我们需要您出示该收据。

المرجع

- 1) المعيار، المؤشر القياسي، النقطة المستخدمة للمقارنة
- 2) تجسيد لصوت Klipsch الأسطوري

حاضرون ونفتخر منذ 1946

في 1946، أحدث Paul W. Klipsch ثورة في صناعة الصوت بإبداعه تقنية الصوت المملوكة لنا والمبادئ الصوتية التي تُعد القوة الدافعة وراء أنظمتنا الصوتية المميزة ذات الشهرة الواسعة.

ولا تزال حتى اليوم أوفياء لرؤية PWK ونجمع الجزء الأفضل من مجهودات وعقريات هذا القرن في كل منتج نصنعه. مكبرات الصوت هذه هي نتيجة شغفنا بالوصول إلى الكمال في الصوتيات. اكتشف قوة ودقة وإحساس الفئة Klipsch Reference.

نحن حماة الصوت.



REFERENCE PREMIERE مكبرات الصوت

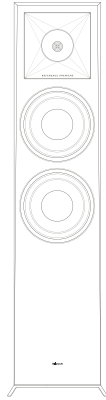

RP-8060FA

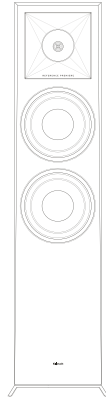

RP-8000F

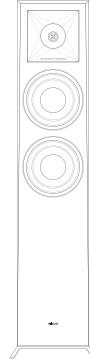

RP-6000F



RP-5000F



RP-4000F



RP-600M



RP-500M



RP-400M



RP-502S

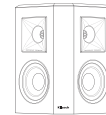

RP-402S



RP-500SA



RP-504C

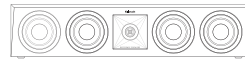

RP-404C

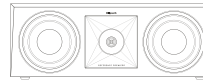

RP-600C

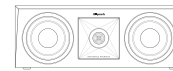

RP-500C

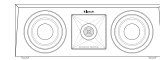

RP-400C

قبل أن تبدأ

لبعض مكبرات الصوت Klipsch® قوائم وكماليات أخرى قد يلزم تركيبها قبل الاستخدام. يُرجى الرجوع إلى الرسوم التخطيطية 1 و 2 و 3 للتركيب.

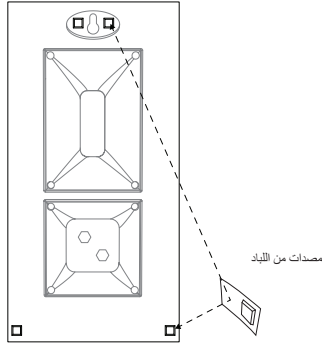

الرسم التخطيطي 1
تركيب على الحائط

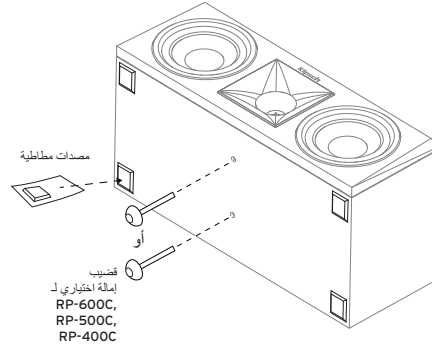

الرسم التخطيطي 2
القنوات المركزية

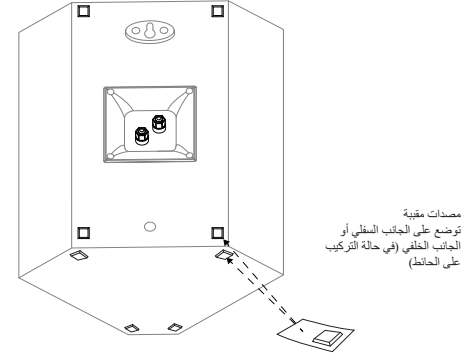

الرسم التخطيطي 3
مكبرات الصوت المحيطي

التوصيلات

قفرغلا يف عضول

مكبرات الصوت ذات القناة الرئيسية اليسرى واليمنى — لأفضل أداء، تفتتح شركة Klipsch (Group, Inc. (KGI وضع مكبرات الصوت بعيدًا عن بعضها بمسافة 6 إلى 15 قدمًا (1.8 إلى 4.6 متر). كما يمكن أيضًا التقريب بينهما قليلاً للحصول على تجسيد سترىو أفضل. يجب أن يكون موضع الاستماع على مسافة تعادل 1 إلى 1.5 مرة تقريبًا للمسافة الفاصلة بين مكبرات الصوت. راجع الشكلين 1 و3 للتوصيل والوضع.

مكبرات القناة المركزية — تم تصميم مكبرات القناة المركزية لوضع الحوار والأصوات الأساسية بحيث تظهر وكأنها تأتي من شاشة فيديو. لذا يجب وضع مكبرات الصوت قريبة قدر الإمكان من الشاشة، ويفضل أعلى الشاشة أو أسفلها مباشرةً. راجع الأشكال 1 و2 و3 للتوصيل والوضع.

مكبرات القناة المحيطة الخلفية — يجب وضع مكبرات صوت Klipsch WDST المحيطة على مسافة قدمين تقريبًا أعلى موضع الاستماع. عادةً ما سيعادل هذا حوالي 5 إلى 7 أقدام أعلى الأرضية. يجب وضع مكبرات الصوت المحيطة على الجدران مباشرةً بالقرب من موضع الاستماع. وقد يكون هناك خيار آخر وهو وضعها على الجدار خلف موضع الاستماع. يعتمد الوضع النهائي لمكبر الصوت المحيطي على مواصفات غرفتك. فهي مصممة لخلق الإحساس بالمساحة والأجواء، وهو ما توفره العديد من تقنيات الصوت المحيطي اليوم. راجع الأشكال 1 و3 و4 للتوصيل والوضع.

التوصيل التقليدي — باستخدام سلك مكبرات صوت مقياس 12-16، قم بتوصيل الطرف الأحمر "الموجب" (+) لمكبر الصوت الأيسر بالطرف الأحمر "الموجب" (+) للقناة اليسرى بمضخم الصوت. قم بتوصيل الطرف الأسود "السالب" (-) لمكبر الصوت الأيسر بالطرف الأسود "السالب" (-) للقناة اليسرى بمضخم الصوت. كرر هذا الإجراء لتوصيل جميع مكبرات الصوت المتبقية بقنوات مضخم الصوت المناسبة. راجع الشكل 3. تأكد من عدم ملامسة أي أسلاك مكشوفة بأي توصيلة لأي أطراف أخرى يمكن أن تتسبب في حدوث دائرة قصر (ماس كهربائي) وإتلاف أجهزتك.

تأتي بعض مكبرات Klipsch Reference مع مرابط توصيل ثنائية والتي يتم توصيلها بشريط معدني. لا تقم بإزالة هذا الشريط وإلا فلن تعمل مكبرات الصوت بشكل صحيح. احتفظ بهذا الشريط في موضعه و قم بتوصيل سلك مكبر الصوت بالمجموعة العلوية لمرباط التوصيل. من الممكن "التوصيل الثنائي" لمكبر صوت واحد يتضمن مجموعتين من مرابط التوصيل. الرجاء مراجعة دليل جهاز الاستقبال لمزيد من التعليمات.

متطلبات مضخم الصوت — مكبرات الصوت Klipsch عالية الكفاءة وستعمل بسهولة على تشكيلة كبيرة من مضخمات الصوت. جميع مكبرات صوت Klipsch متوافقة مع مقاومة كهربية بمقدار 8 أوم ويمكن استخدامها بمستويات عالية جدًا مع تشويه منخفض. ونظرًا للمستويات الخرج العالية، تكون مكبرات صوت Klipsch قادرة على إعادة إنتاج الصوت، لذا توخ الحذر مع التحكم في مستوى الصوت. مستوى الصوت المفرط على مدى فترات زمنية طويلة يمكن أن يلحق الضرر بحاسة السمع بشكل دائم. كما قد يؤدي التسخن المفرط لمضخم الصوت أيضًا إلى الإضرار بمكبرات الصوت. استشر الموزع الخاص بك أو راجع دليل مضخم الصوت للتأكد من أن مضخم الصوت الخاص بك تحديدًا هو أفضل خيار مناسب لتطبيقك. نحن نرغب في أن تستمتع بالاستماع مدى الحياة.

الشكل 1
وضع مكبرات الصوت في منطقة استماع

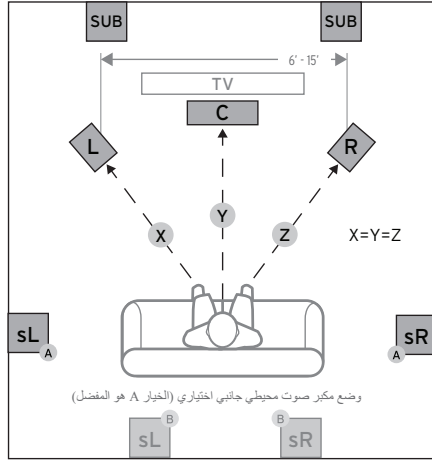

SUB - مضخم الصوت
TV - جهاز التلفزيون
L - يسار
C - مركزي
R - يمين
sL - مكبر تابع على اليسار
sR - مكبر تابع على اليمين

الشكل 3
التوصيلات القياسية

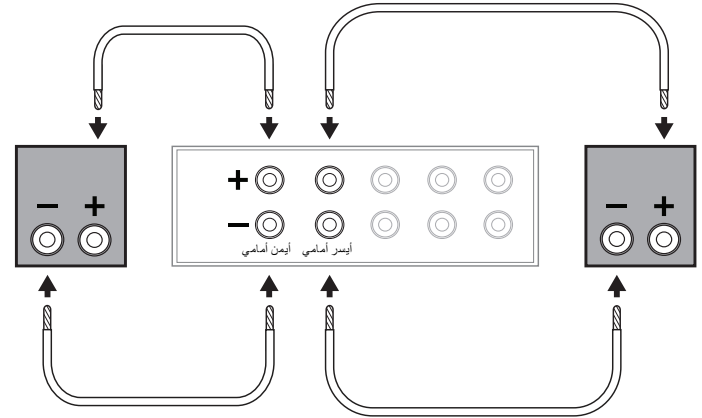

الشكل 2
القناة المركزية

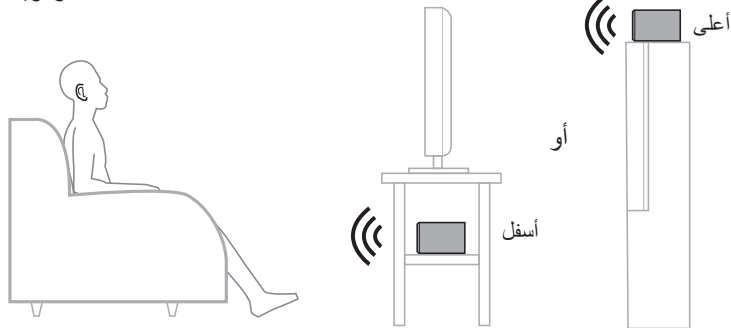

الشكل 4
التركيب على الحائط

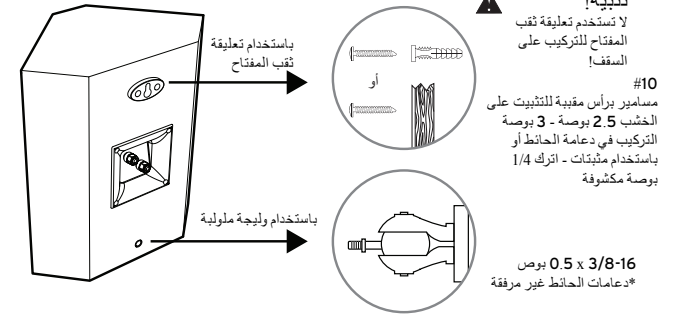

REFERENCE PREMIERE آيبن قتب ءدوزم DOLBY ATMOS®

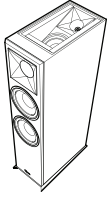

RP-8060FA

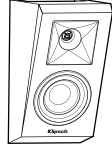

RP-500SA

- 1 ATMOS FRONT
- 2 ATMOS REAR
- 3 SIDE SURROUND
- 4 REAR SURROUND

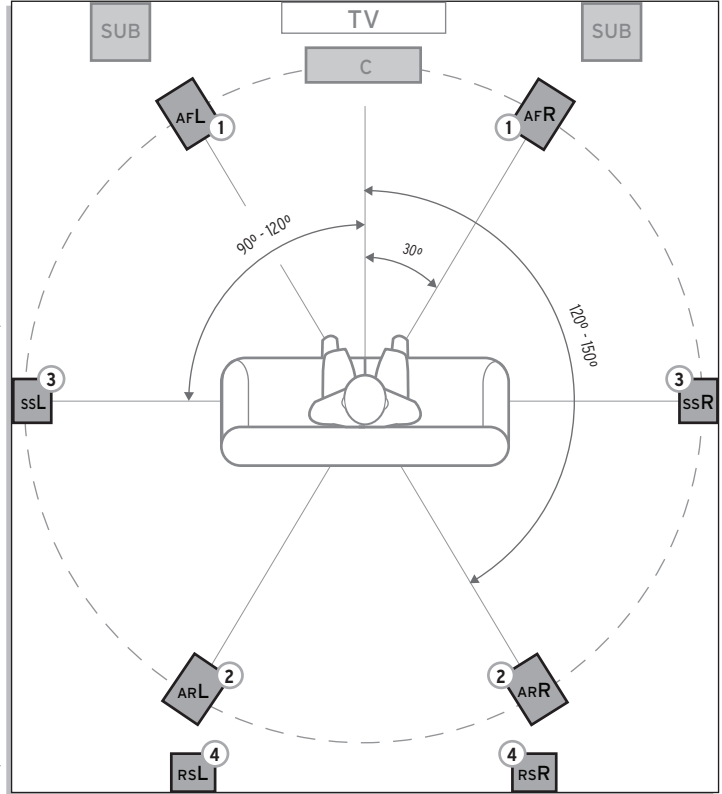
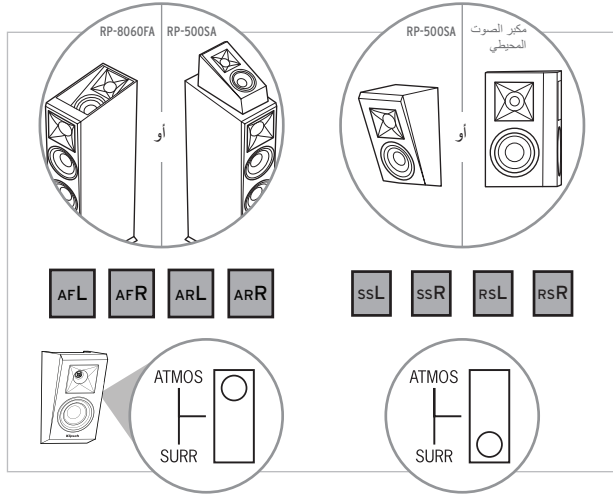

عامتسا ءقطنم يف توصولا تارباكم عضو

REFERENCE PREMIERE ةينق ت ب ةدوزم DOLBY ATMOS®

التوصيلات

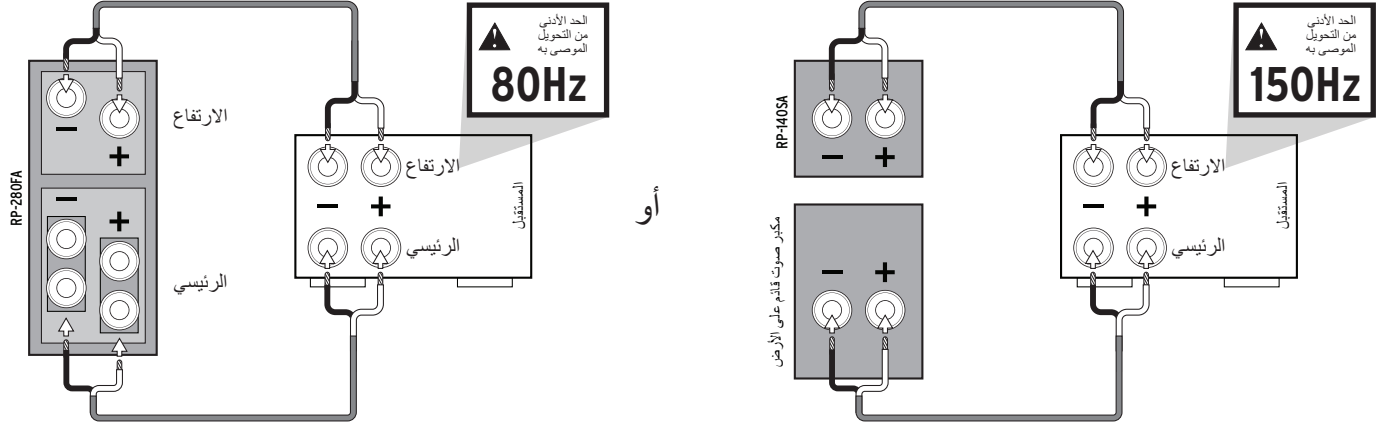

مكبر صوت رأسي

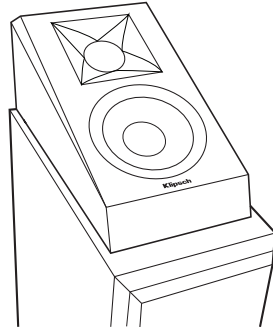

من الممكن إضافة كابينة RP-500SA
لأي إعداد مكبر صوت سلبي

التركيب بالحائط

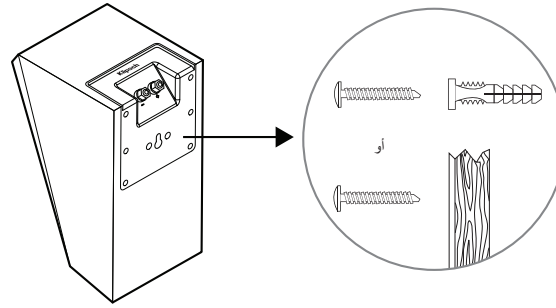

تنبيه!
لا تستخدم تعليقة ثقب
المفتاح للتركيب على
السقف!
#10
مسامير برأس مقببة للثنيث على
الخشب 2.5 بوصة - 3 بوصة
التركيب في دعامة الحائط أو
بالمستخدم مثبتات - اترك 1/4
بوصة مكشوفة

تسجيل المنتج

سجل منتجك عبر الإنترنت على www.klipsch.com/register

- كن على اطلاع بالمنتجات والعروض الجديدة.
 - لن يُعاد بيع معلومات الشخصية مطلقاً.
 - لا تُستخدم معلومات التسجيل هذه لأغراض الضمان.
- الرجاء الاحتفاظ بالإيصال لمطالبات الضمان.

العناية والتنظيف

الشيء الوحيد الذي قد تحتاج أن تفعله هو أن تقوم بإزالة الغبار عن مكبرات الصوت الخاصة بك من حين لآخر. واحذر من استخدام أي منظف كاشط أو به مذيب أو أي مادة منظفة شديدة. يمكنك تنظيف الشبكات باستخدام الفرشاة المرفقة بالمكنسة الكهربائية.





Klipsch®

KEEPERS OF THE SOUND®

3502 WOODVIEW TRACE, INDIANAPOLIS, IN, USA

KLIPSCH.COM



Manufactured under license from Dolby Laboratories. Dolby, Dolby Atmos and the double-D symbol are registered trademarks of Dolby Laboratories.

V03 - 180507

1-800-KLIPSCH ©2015 KLIPSCH GROUP, INC. ALL RIGHTS RESERVED. KLIPSCH AND KEEPERS OF THE SOUND ARE REGISTERED TRADEMARKS OF KLIPSCH GROUP, INC. IN THE USA AND OTHER COUNTRIES.
A WHOLLY-OWNED SUBSIDIARY OF VOXX INTERNATIONAL CORPORATION. MANUFACTURED UNDER LICENSE FROM DOLBY LABORATORIES. DOLBY ATMOS IS A REGISTERED TRADEMARK OF DOLBY LABORATORIES.