



# CITY



60186





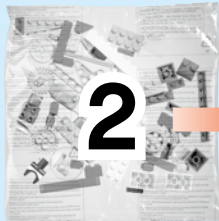
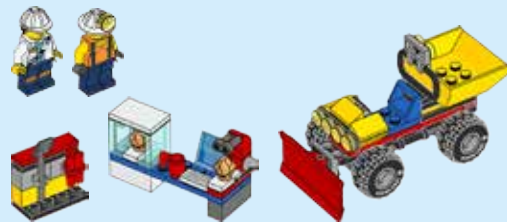

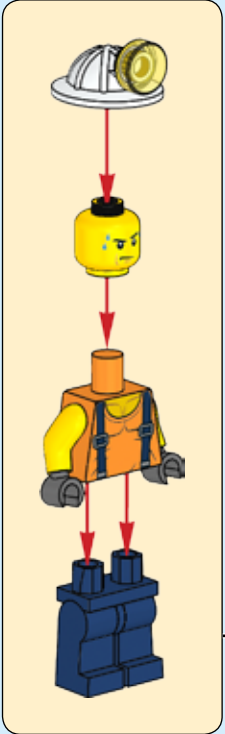
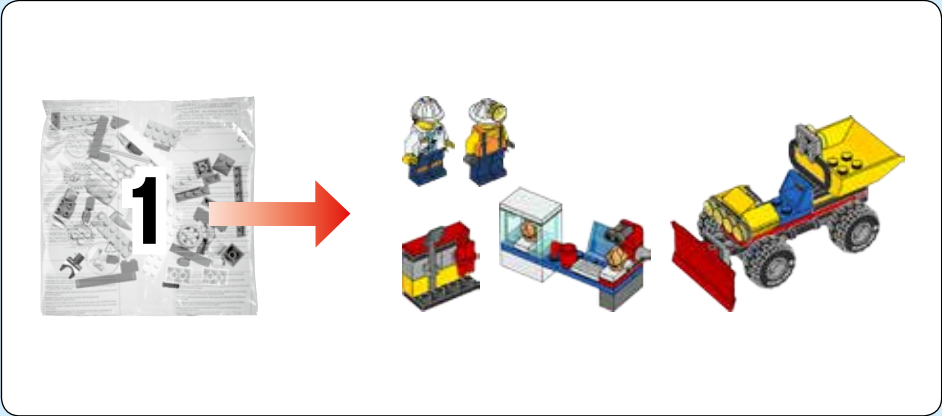

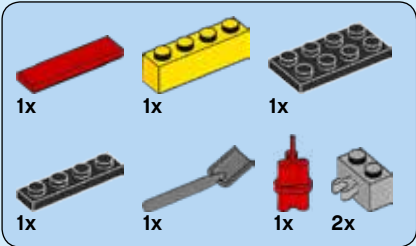

1

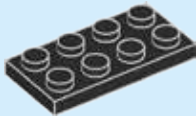

2

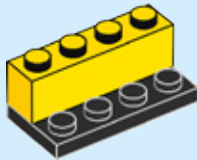

3

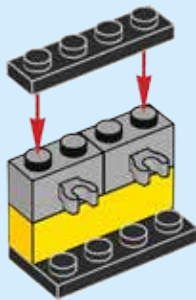

4

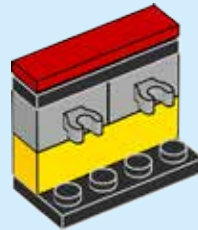

5

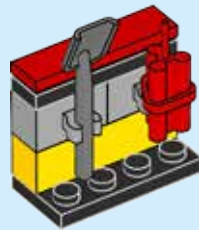



1x

**1**

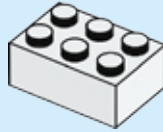

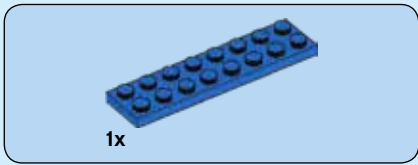

**2**

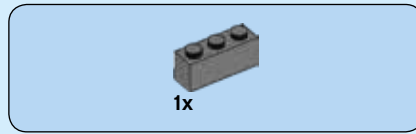
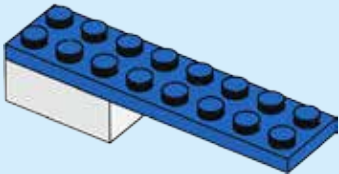

**3**

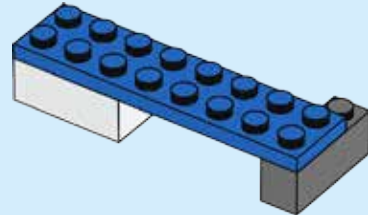



1x

4

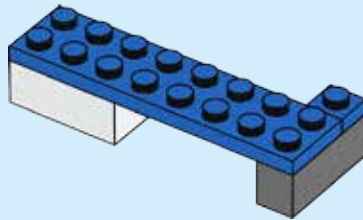





1x



1x

5

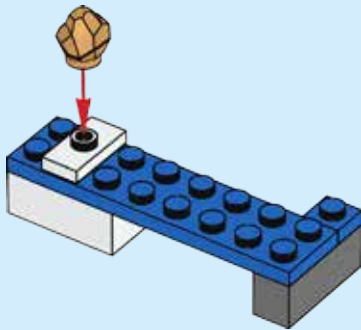

2x

6

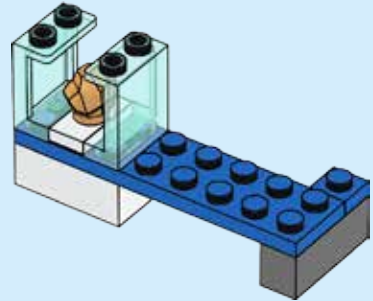



1x

7

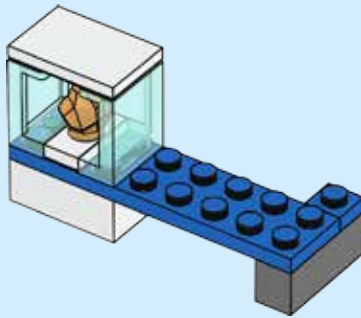

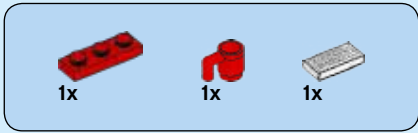

8

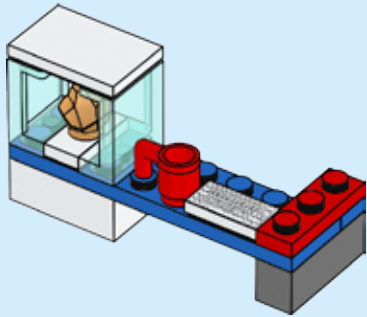

9

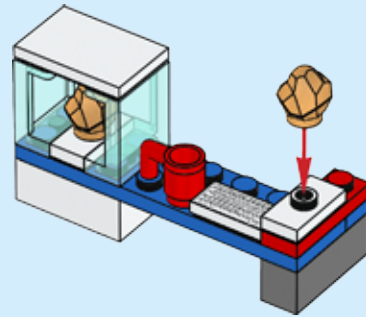

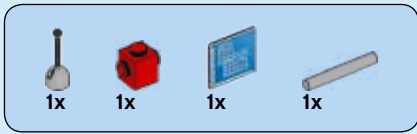

10

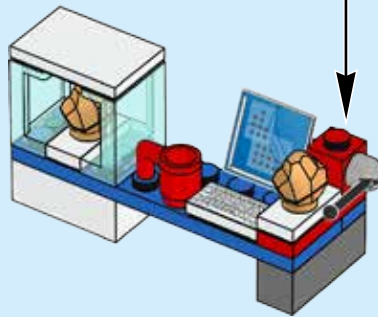
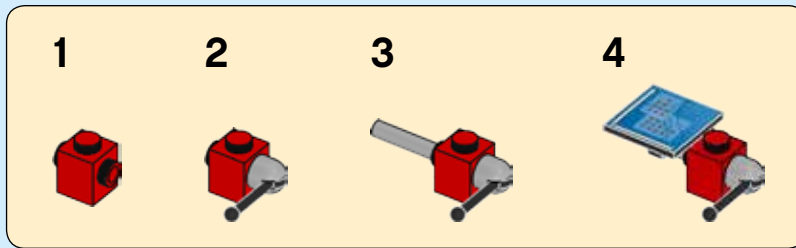



11

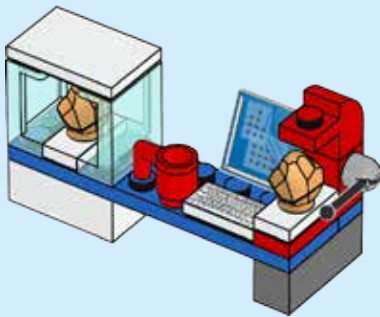

12

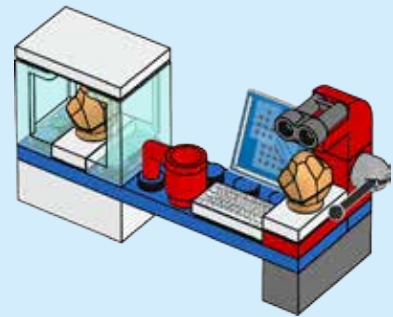

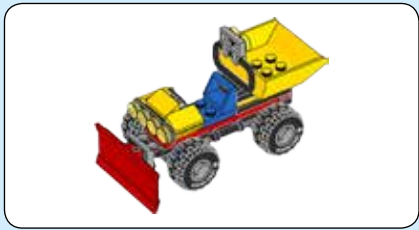

1

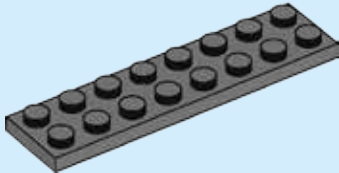



2

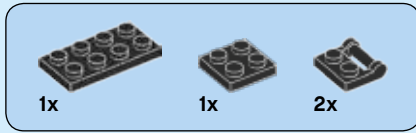
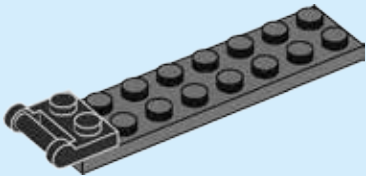

3

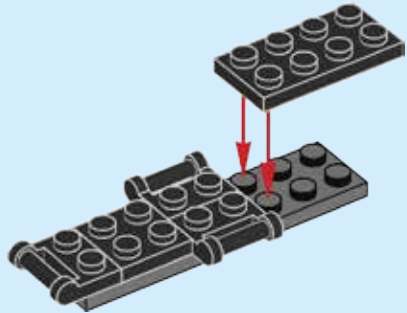

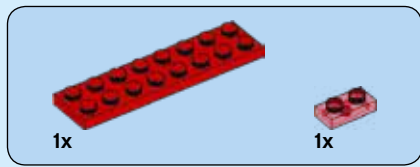

4

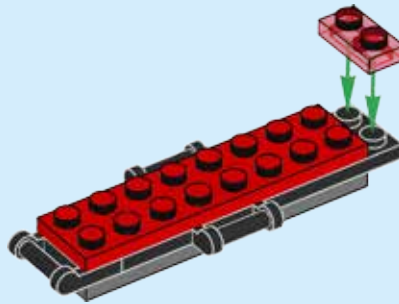





5

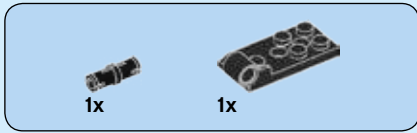
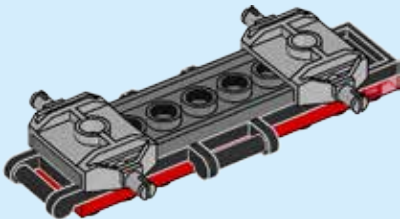
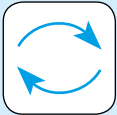

6

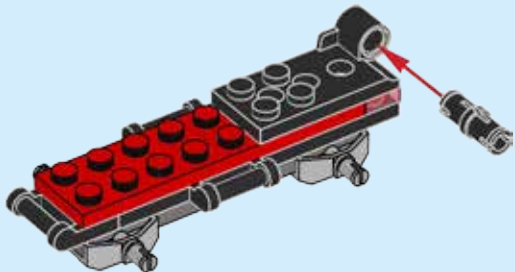
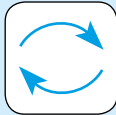

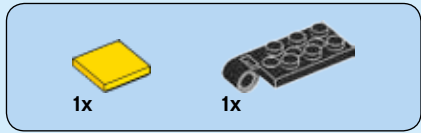

7

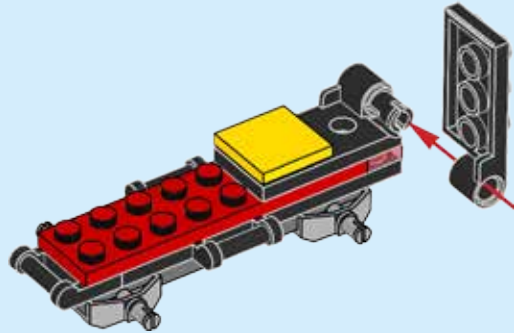

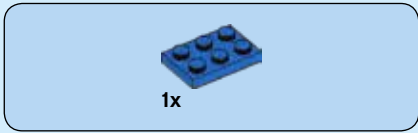

8

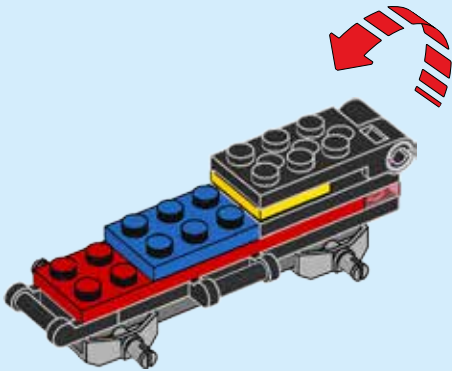

9

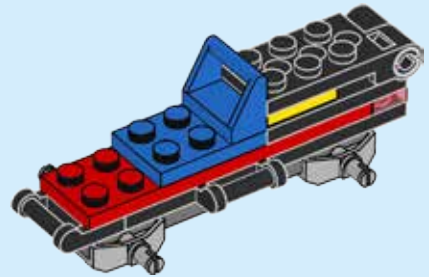

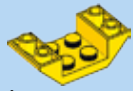

1x

10

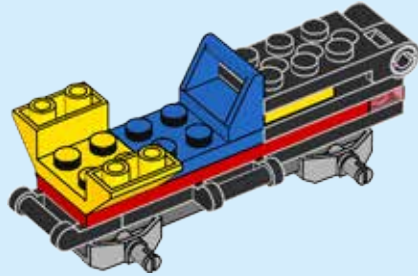



11

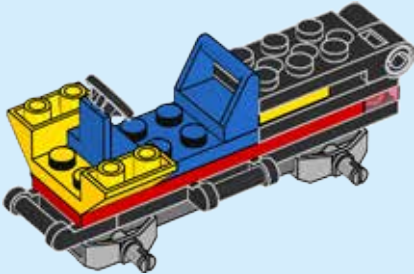

12

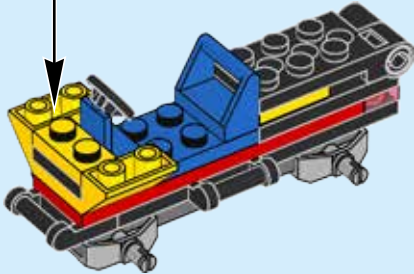
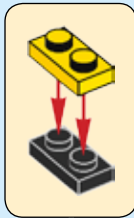



1x

13

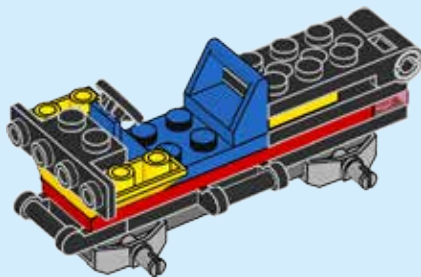

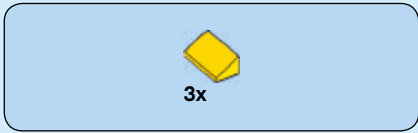

14

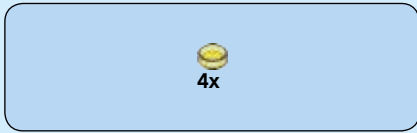
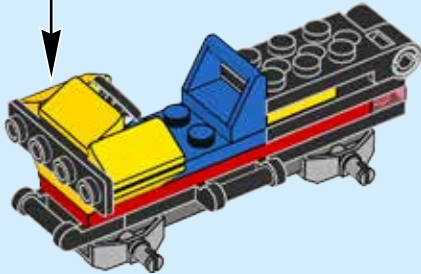
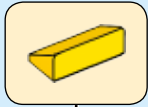

15

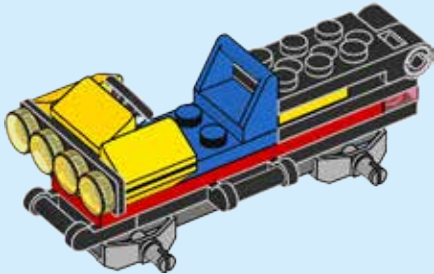



1x

16

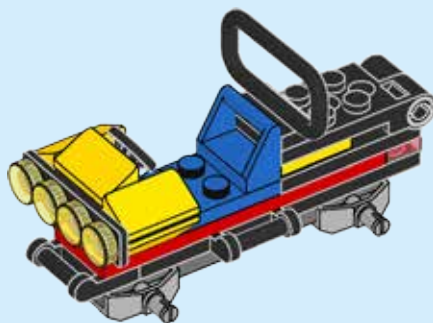



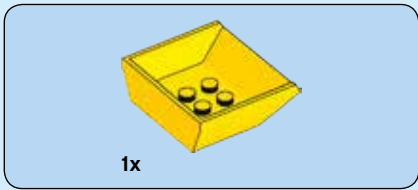

17

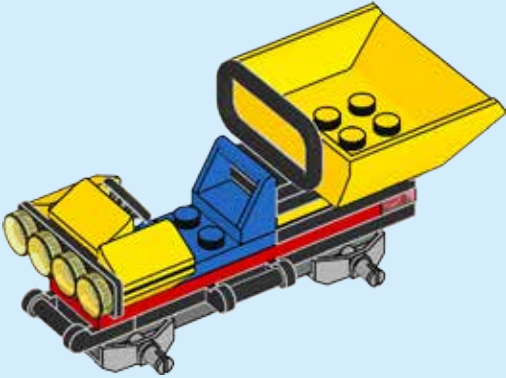

18

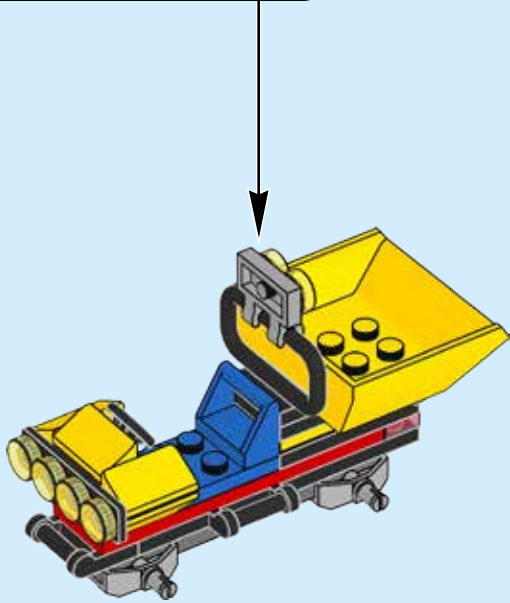
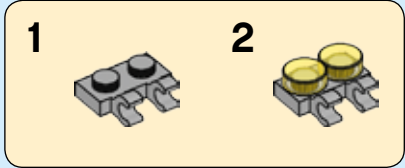

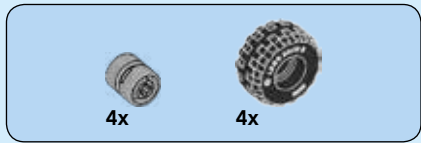

19

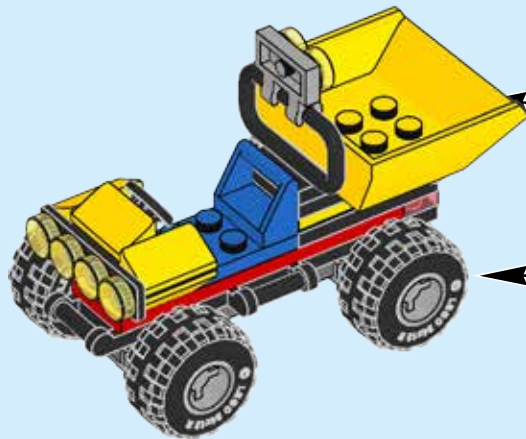
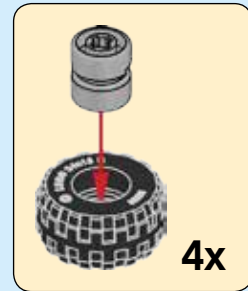

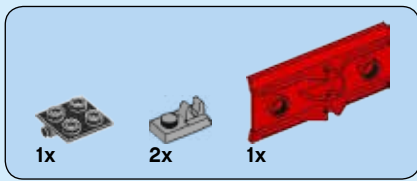

20

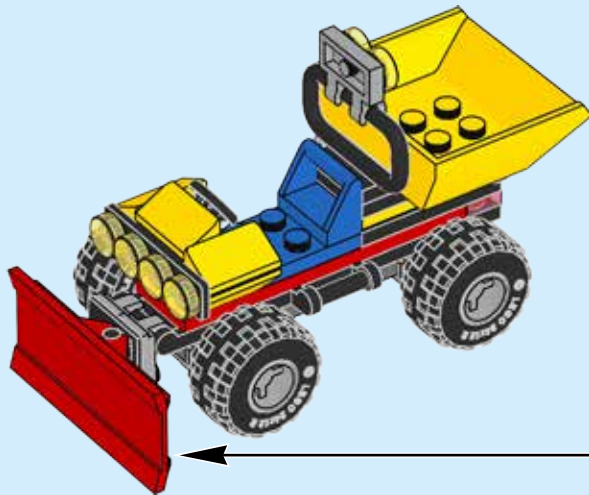
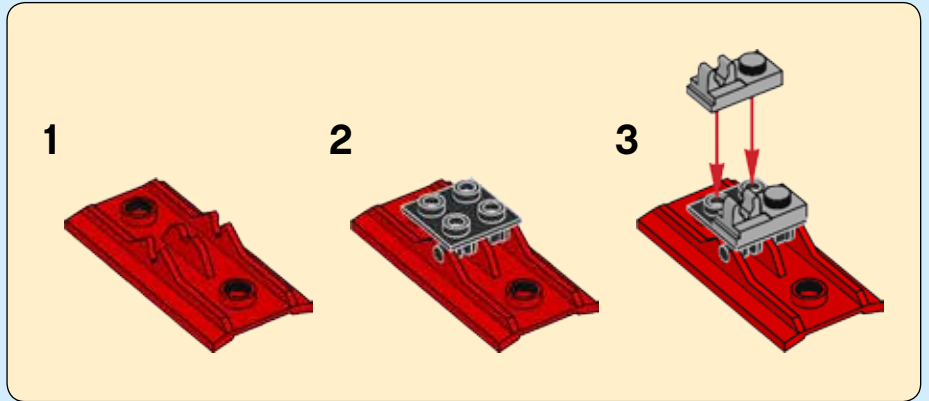

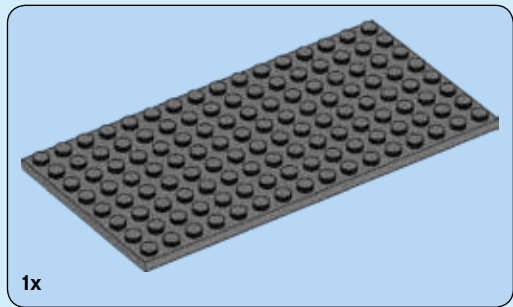
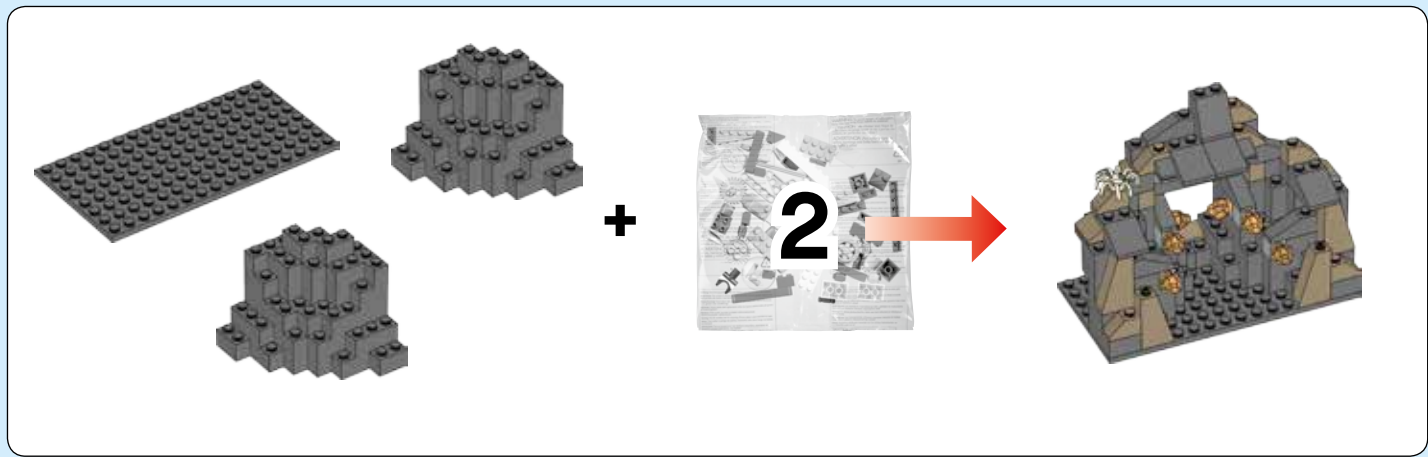

1

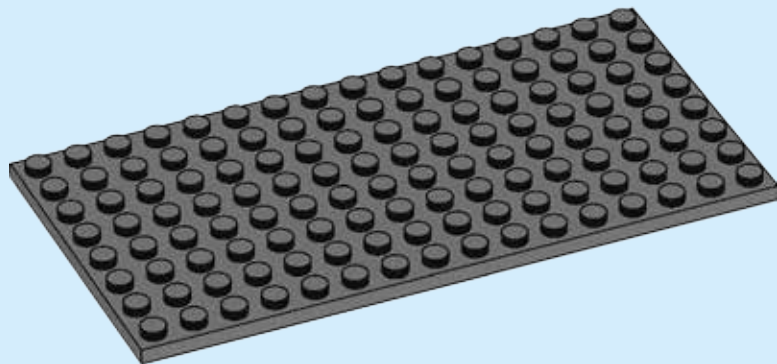

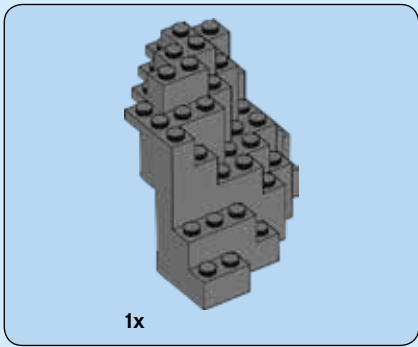

2

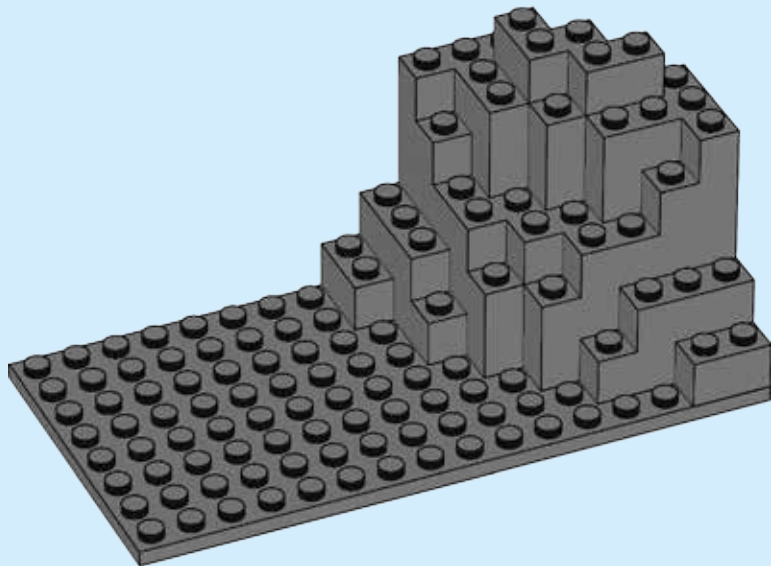

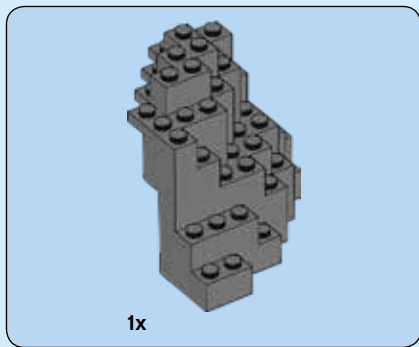

3

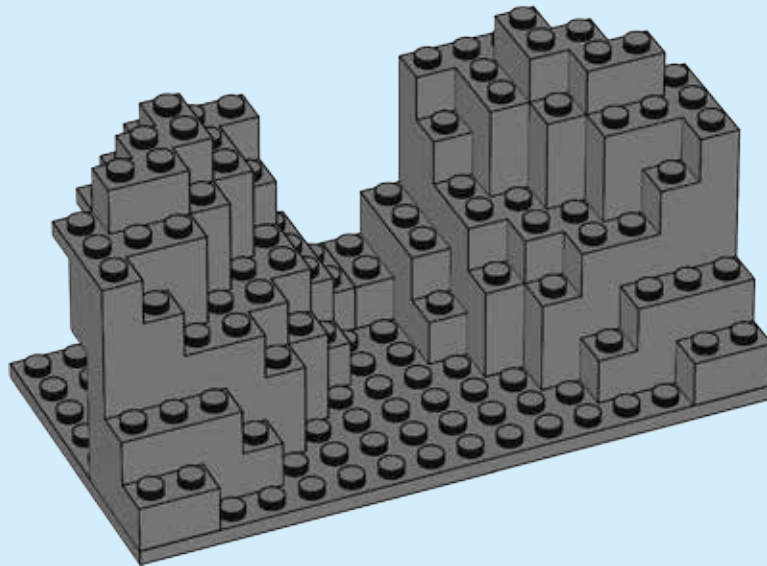



4

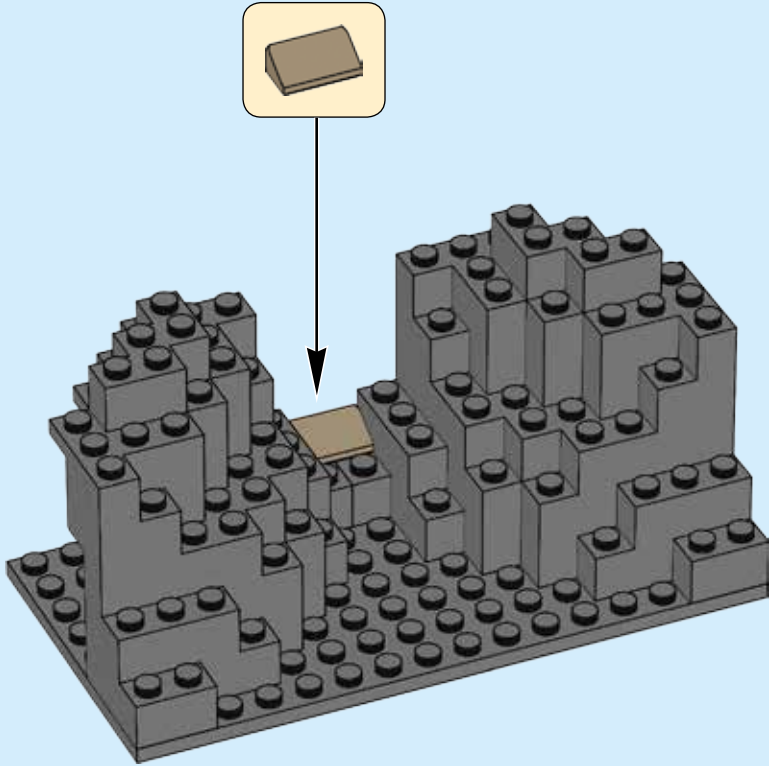



6x



6x

5

1



2



6x

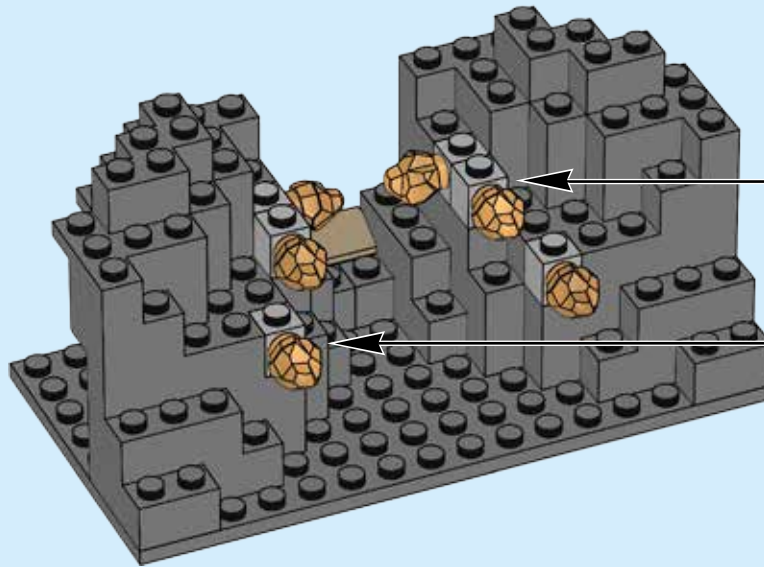





4x

6

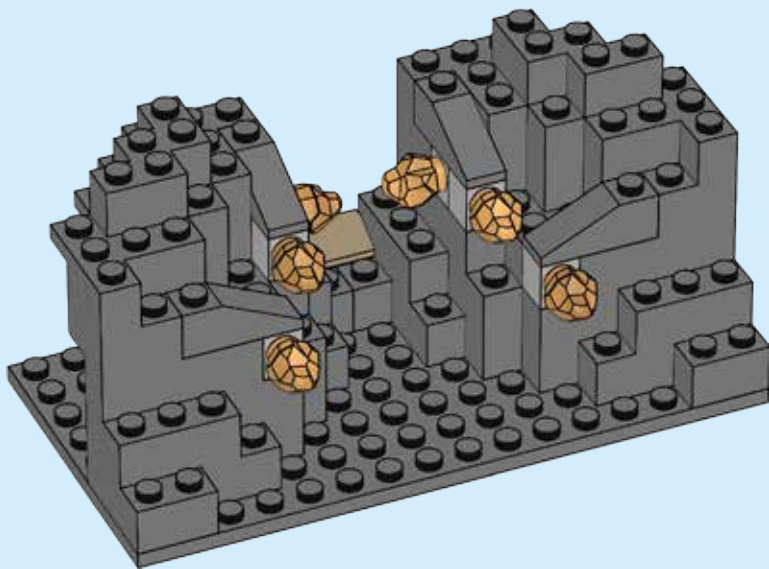

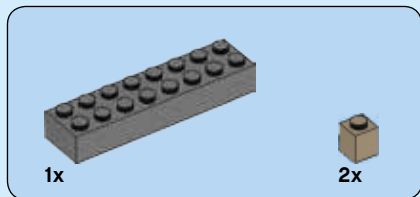

7

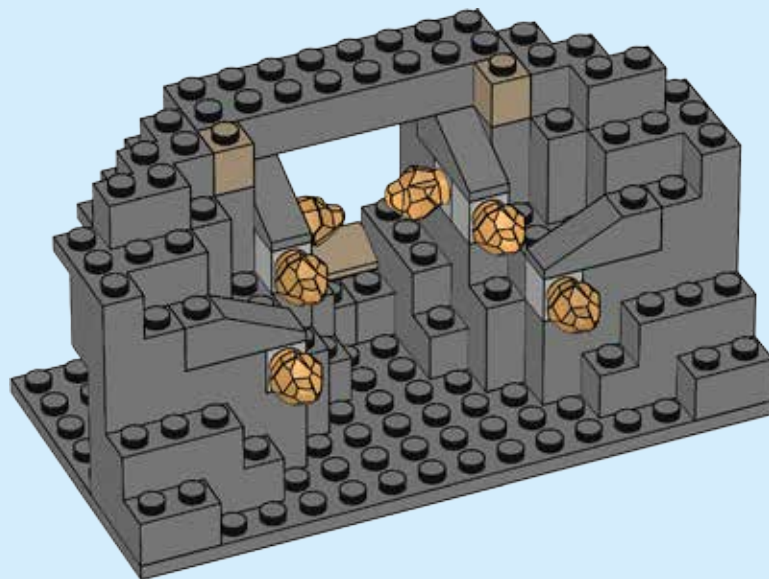

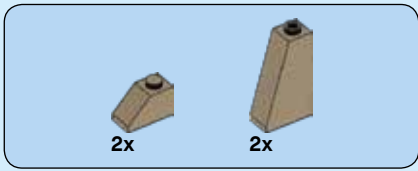

8

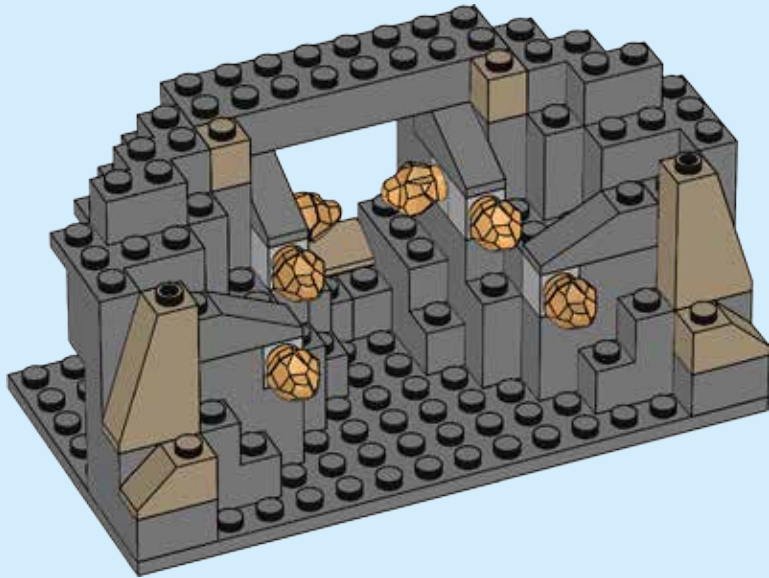



9

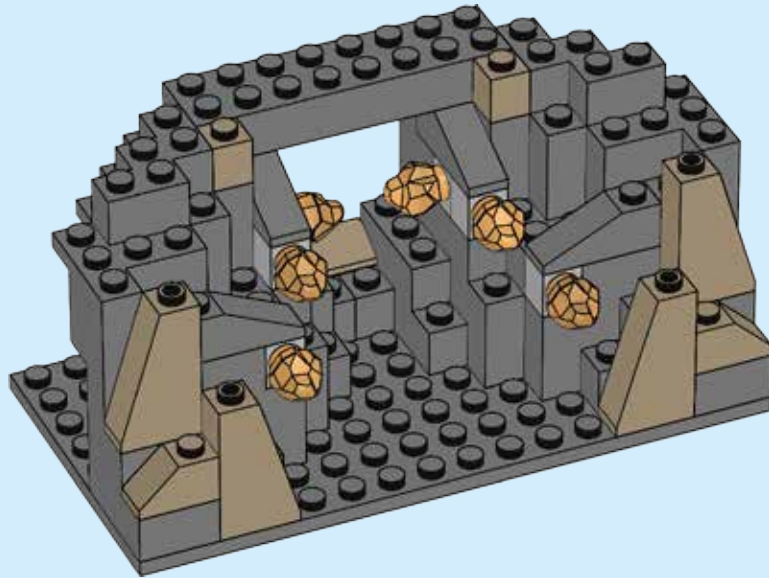



2x

10

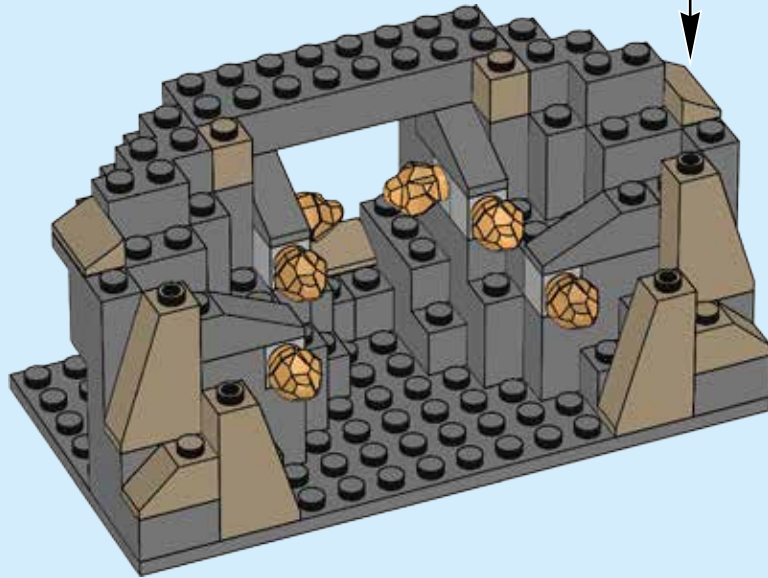
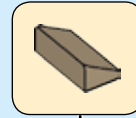



2x

11

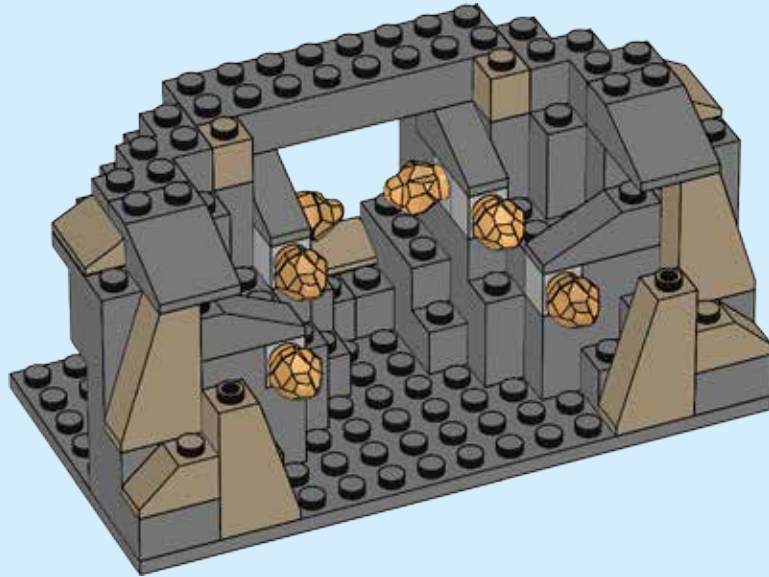

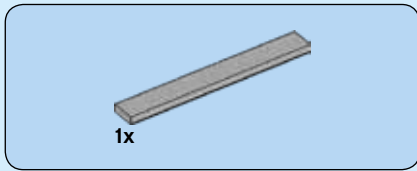

12

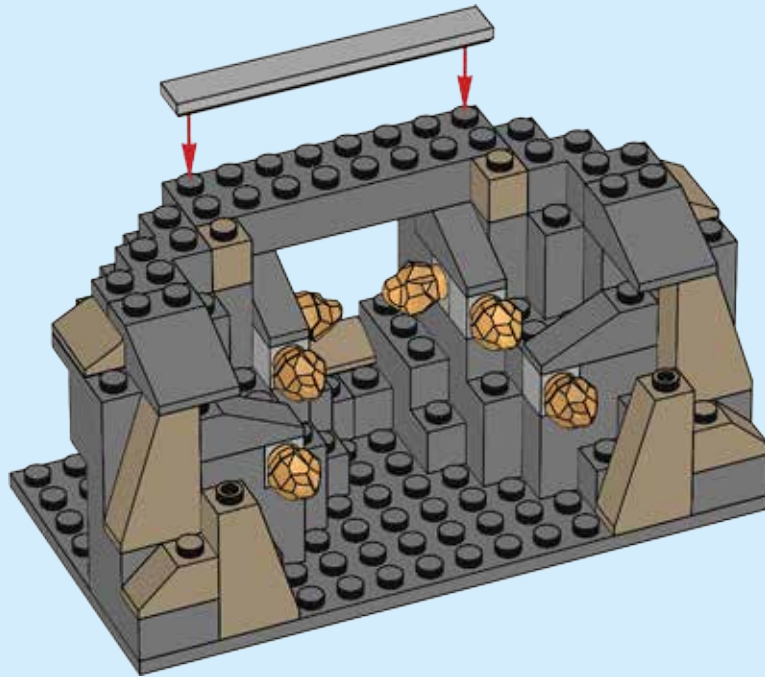



2x

13

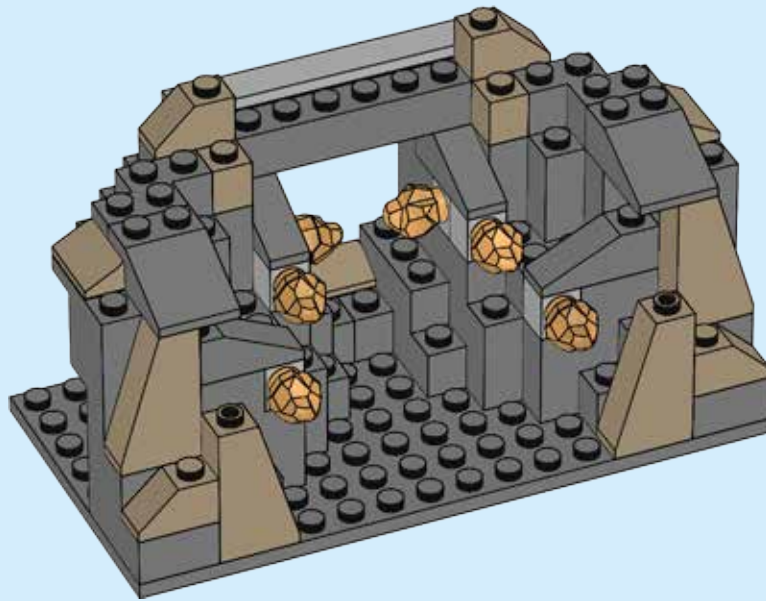





2x

14

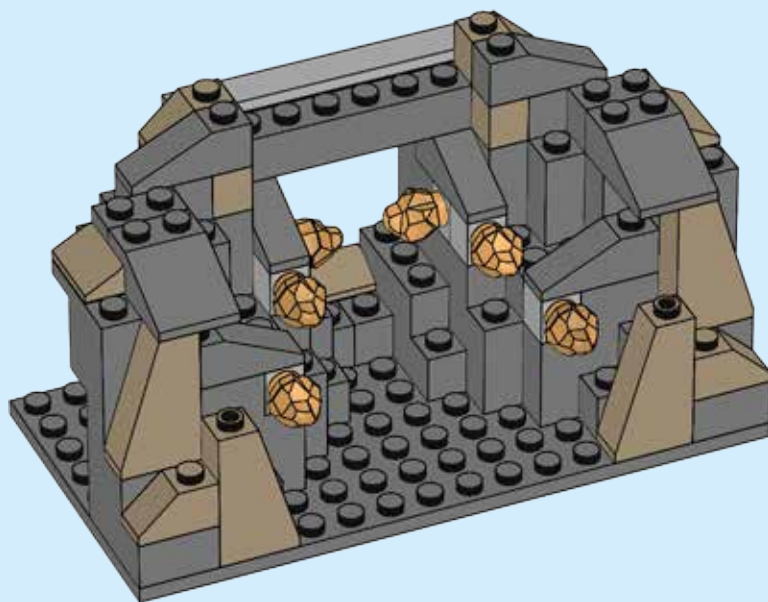



2x

15

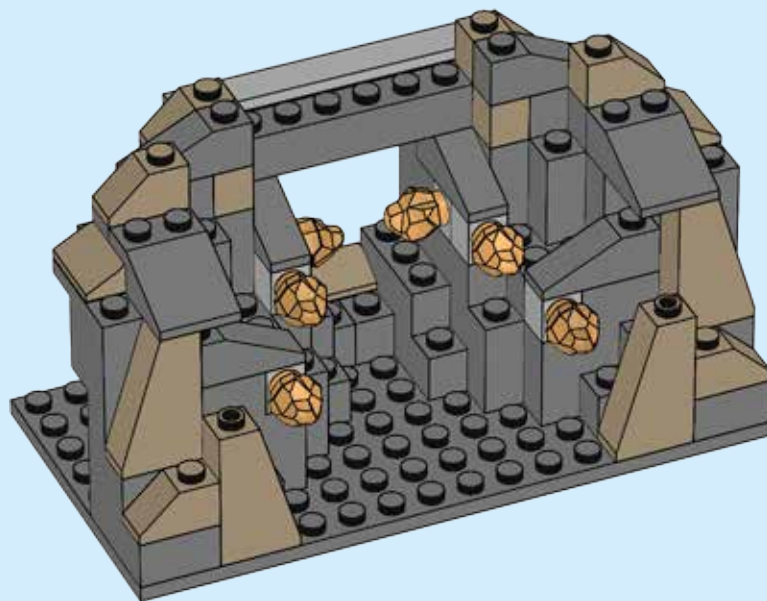

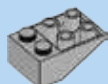

3x

16

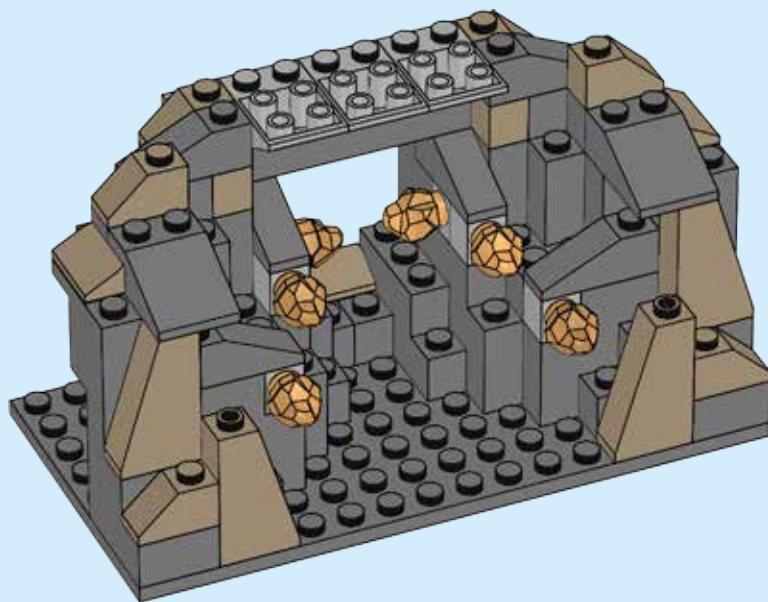

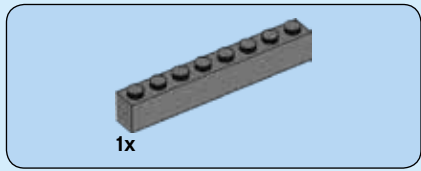

17

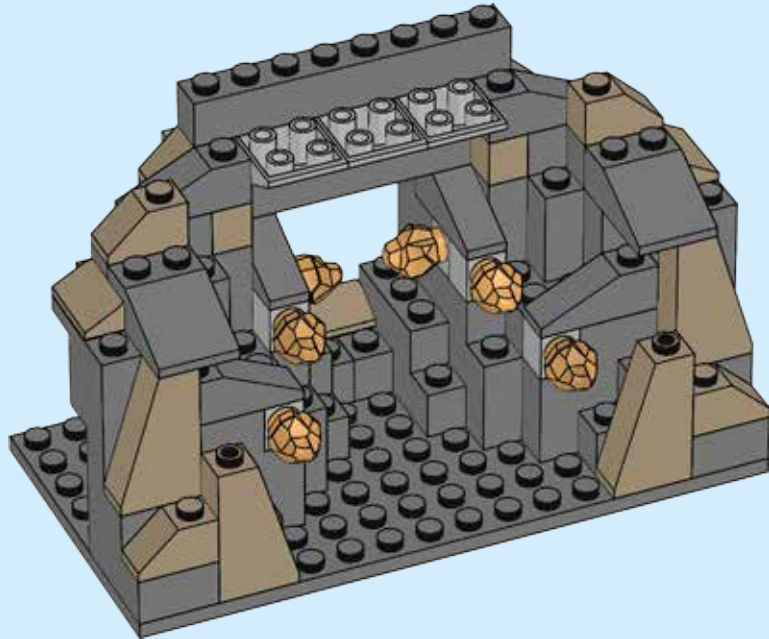

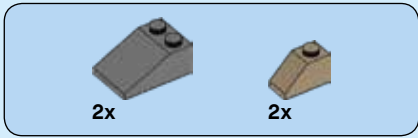

18

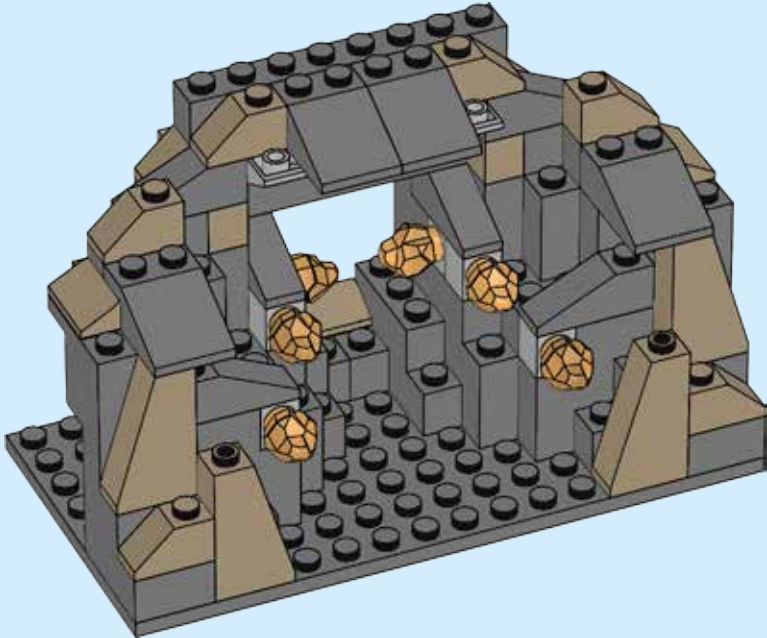



2x

19

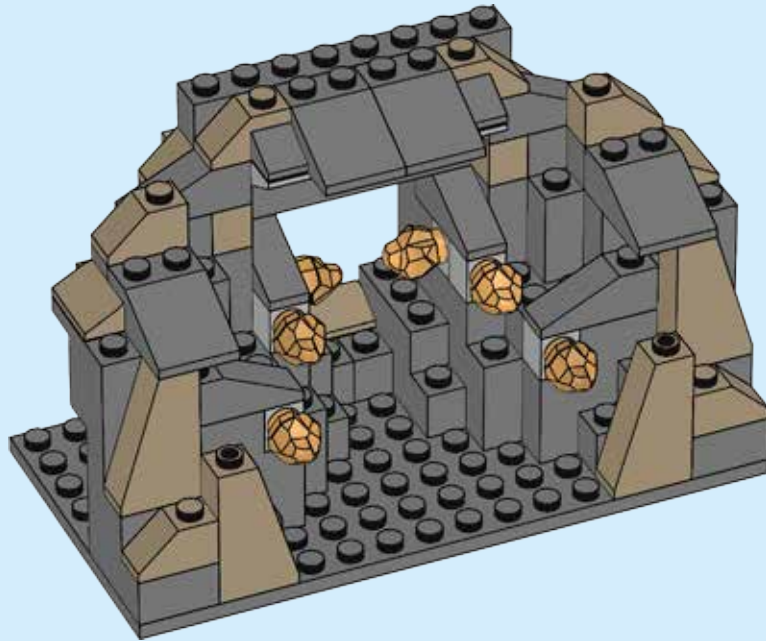



1x

20

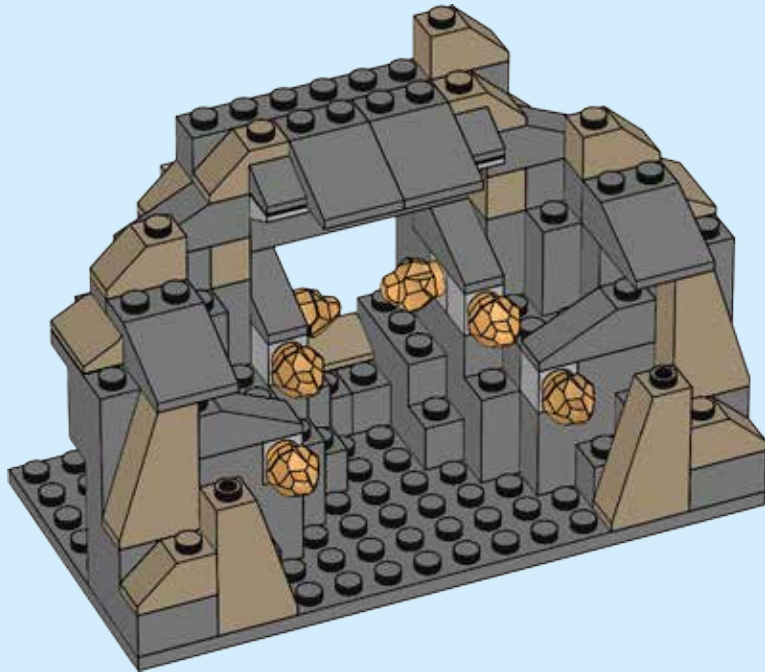

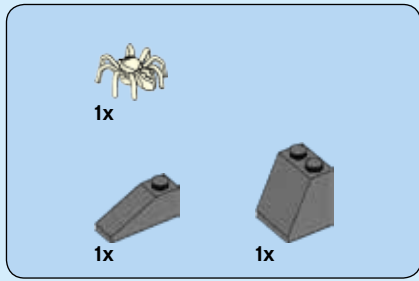

21

