

DYMO®

LabelWriter®

Wireless



User Guide

Copyright

© 2017 Sanford, L.P. All rights reserved. 7/17

No part of this document or the software may be reproduced or transmitted in any form or by any means or translated into another language without the prior written consent of Sanford, L.P.

Trademarks

DYMO, DYMO Label, and LabelWriter are registered marks in the US and other countries. All other trademarks are the property of their respective holders.

FCC and IC Statement

Caution: The user is cautioned that changes or modifications not expressly approved by the party responsible for compliance could void the user's authority to operate the equipment.

Note: This equipment has been tested and found to comply with the limits for a Class B digital device, pursuant to part 15 of the FCC Rules. These limits are designed to provide reasonable protection against harmful interference in a residential installation. This equipment generates, uses and can radiate radio frequency energy and, if not installed and used in accordance with the instructions, may cause harmful interference to radio communications. However, there is no guarantee that interference will not occur in a particular installation. If this equipment does cause harmful interference to radio or television reception, which can be determined by turning the equipment off and on, the user is encouraged to try to correct the interference by one or more of the following measures:

- Reorient or relocate the receiving antenna.
- Increase the separation between the equipment and receiver.
- Connect the equipment into an outlet on a circuit different from that to which the receiver is connected.
- Consult the dealer or an experienced radio/TV technician for help.

This device complies with Industry Canada licence-exempt RSS standard(s). Operation is subject to the following two conditions:

- 1 this device may not cause interference, and
- 2 this device must accept any interference received, including interference that may cause undesired operation of this device.

This equipment complies with IC RF radiation exposure limits set forth for an uncontrolled environment.

Restrictions: The device operates in the 5150-5350 MHz band and is only for indoor use to reduce the potential for harmful interference to co-channel mobile satellite systems. The antenna(s) used for this transmitter must be installed and operated to provide a separation distance of at least 20 cm from all persons and must not be collocated or operating in conjunction with any other antenna or transmitter. Installers must ensure that 20 cm separation distance will be maintained between the device (excluding its handset) and users.

CE Statement

Restrictions in the 5 GHz band:

According to the Article 10 (10) of Directive 2014/53/EU, the packaging shows that this radio equipment will be subject to some restrictions when placed on the market in Belgium (BE), the Czech Republic (CZ), Denmark (DK), Germany (DE), Estonia (EE), Ireland (IE), Spain (ES), France (FR), Croatia (HR), Italy (IT), Latvia (LV), Lithuania (LT), Luxembourg (LU), Hungary (HU), Netherlands (NL), Austria (AT), Poland (PL), Portugal (PT), Slovenia (SI), Slovakia (SK), Finland (FI), Sweden (SE), the United Kingdom (UK), Turkey (TR), Norway (NO), and Switzerland (CH). The WLAN function for this device is restricted to indoor use only when operating in the 5150 to 5350 MHz frequency range.

Contents

1	Safety Precautions
2	Environmental Information
3	About Your New Label Printer
3	Registering Your Product
3	Getting to Know the Label Printer
5	Power
5	Label Feed buttons
6	Wireless Status Light
6	WPS Button
6	RESET
6	Label Release Lever
6	Label Guide
6	About Labels
7	System Requirements
8	Designing and Printing Labels
8	DYMO Label Software
8	DYMO Connect Mobile App
8	DYMO Stamps (US Only)
8	Developer and SDK Information
10	Getting Started
10	Connecting the Power
10	Loading Labels
12	Connecting the Printer to your Wireless Network
12	Connecting the Printer using WPS
12	Connecting the Printer using the Quick Setup Wizard
13	Printing Labels
13	Printing Labels from a Computer
14	Printing Labels from a Mobile Device
14	Connecting the Printer using a USB Cable
15	LabelWriter Wireless Printer Configuration
15	Accessing the Web Configuration Utility
16	Web Configuration Menu
16	Running the Quick Setup Wizard
16	Connecting to a Wireless Network
17	Getting a WPS Pin Code
17	Managing the Printer's Access Point
18	Connecting the Printer to a Different Network
19	Changing the Settings
19	Changing the Password
19	Renaming the Printer
20	Changing the Language
20	Changing the Session Timeout
21	Caring for Your Printer
22	Getting Help
22	Wireless Status Light
22	Power Status Light

- 23 Wireless Connection Issues
- 25 Printer Issues
- 27 Resetting the Printer to Factory Default Settings
- 27 Obtaining Customer Support

28 Documentation Feedback

29 Technical and Environmental Information

- 29 Technical Specifications
- 30 Wireless Specifications

30 Device Certification

Safety Precautions

Read and understand all of the precautions listed below. Follow all warnings and instructions marked on the product.

General

- Dispose of plastic bags correctly and keep away from babies and children.
- Place the product on a flat, stable surface.
- Always use the product as instructed in this user guide.
- Unplug the power cord immediately if you notice any abnormal odor, heat, smoke, discoloration, deformation or anything unusual while using the product.
- Do not disassemble the product. For inspection, adjustment and repair of the product, contact DYMO Customer Support.
- Do not drop, hit, or otherwise mishandle the product.
- Do not allow any liquids to come into contact with the product.
- Make sure to turn off the power, if applicable, and remove the power cord from the electrical outlet before cleaning the product. Failure to do so could cause an electrical shock or fire.
- Do not insert foreign objects into the product.
- Do not use paint thinner, benzene, alcohol or any other organic solvents to clean the product. Doing so may cause damage to the surface finish. Use a soft, dry cloth to clean the product.

Power

- Use only the power cord and adapter that came with the product.
- Do not handle the power cord or adapter if your hands are wet.
- Do not cut, damage, alter, or place heavy objects on the power cord.
- Do not use the power cord or adapter if they are damaged.
- Do not pull the power cord when removing the plug from the electrical outlet. Doing so could cause an electrical shock or fire.
- Do not use the power adapter in a confined space or cover it with a cloth. Make sure there is sufficient ventilation to prevent the power adapter from overheating.
- If the product will not be used for an extended period of time, remove the power cord from the electrical outlet.

Printer

- Do not put fingers in moving parts or openings of the product.
- Do not block or insert objects into the label exit slot.
- Do not touch the tear bar. Personal injury could result.
- Do not place the product in areas exposed to direct sunlight, near heaters or other hot appliances, or in any area exposed to extremely high or low temperatures, high humidity, or excessive dust.
- Do not hold or lift the product by the cover.

Labels

- Use only DYMO-branded labels. The product's warranty does not cover any malfunction or damage caused by the use of third-party labels.
- Apply labels only to a clean, dry surface at room temperature.
- Do not expose label rolls to direct sunlight, high temperatures, high humidity, or dust. Store in a cool, dark place.

Environmental Information

The equipment that you have bought requires the extraction and use of natural resources for its production. It may contain substances that are hazardous to health and the environment.

In order to avoid the dissemination of those substances in our environment, and to diminish the pressure on natural resources, we encourage you to use the appropriate take-back systems. These systems will reuse or recycle most of the materials of your end-of-life equipment in an environmentally sound way.

The crossed-bin symbol marked on your device indicates you should use these systems.



If you need more information on the collection, reuse, and recycling of this product, please contact your local or regional waste administration.

You can also contact DYMO for more information on the environmental performance of our products.

About Your New Label Printer

Congratulations on purchasing a DYMO LabelWriter Wireless label printer. Your LabelWriter printer will give you years of reliable label printing. We encourage you to take a few minutes to review how to use and care for your printer.

Visit www.dymo.com for information on obtaining labels and accessories for your label printer.

Registering Your Product

Visit www.dymo.com/register to register your label printer online. During the registration process, you will need the serial number, which is located on the bottom of the label printer.

Register your label printer to receive these benefits:

- Email notification of free software upgrades
- Special offers and new product announcements



Serial number on bottom of printer

Getting to Know the Label Printer

Your LabelWriter printer is a direct thermal printer and does not use ink or toner. Instead, the printer uses heat from a thermal print head to print on specially treated, heat-sensitive labels. Labels are the only supplies you will ever need to buy.

Become familiar with the features shown in the following figures.

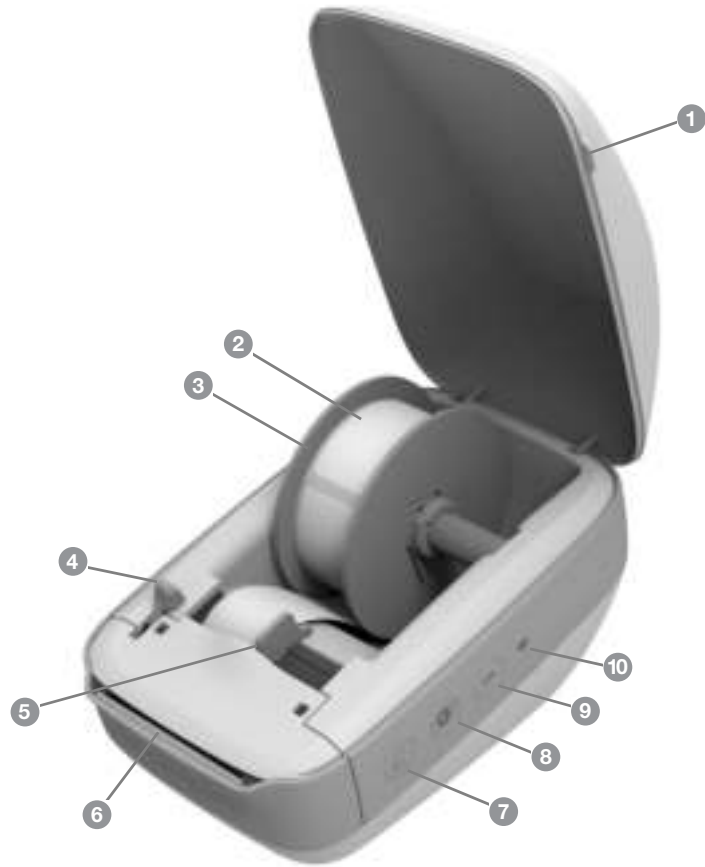

- | | | |
|-----------------------|---------------------------------------|--------------------------|
| 1 Cover handle | 5 Label guide | 9 Label reverse feed |
| 2 Label roll | 6 Label exit slot and tear bar | 10 Wireless status light |
| 3 Label spool | 7 Label forward feed | |
| 4 Label release lever | 8 Power (On/Off) Printer status light | |

Right side view

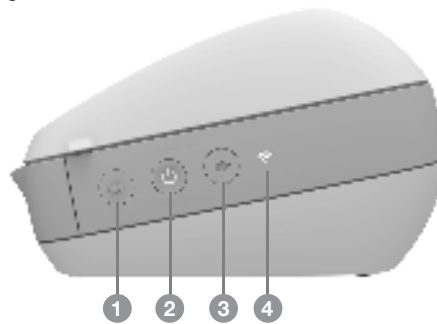

Back view





- | | |
|---|-------------------------------|
| 1 Label forward feed | 5 Power connector |
| 2 Power (On/Off) and Printer status light | 6 USB connector |
| 3 Label reverse feed | 7 RESET |
| 4 Wireless status light | 8 Wi-Fi Protected Setup (WPS) |

Power

The  button turns the label printer power on and off. After five minutes of inactivity, the printer will enter power-saving mode and the power status light will glow.

Refer to **Power Status Light** on page 22 for more information.

Label Feed buttons

The  label forward feed button on the side of the printer advances a single label. The  label reverse feed button reverses the label out of the label exit slot and is used to remove labels from the printer when changing rolls.



Wireless Status Light

The wireless status light visually shows the current wireless state of the printer. Refer to **Wireless Status Light** on page 22 for more information.

WPS Button

The Wi-Fi Protected Setup (WPS) button can be used to connect the printer to your WPS-enabled router. You have two minutes to press both the WPS button on your router and on the printer. See **Connecting the Printer using WPS** on page 12.

For information about whether your router supports WPS, refer to the documentation that came with your router.

RESET

Pressing the RESET button for longer than five seconds returns the printer to the factory default settings. This will delete any network or other settings you may have saved.

Short press (1-5 seconds) Restarts the printer without deleting your settings.

Long press (more than 5 seconds) Deletes all the printer settings and returns the printer to the default factory settings. The printer starts up in Access Point mode and the quick setup wizard automatically starts when you connect to the printer from your computer.

Label Release Lever

The label release lever releases the pressure of the print head from the labels so that the labels can be easily removed from the label exit slot.

Label Guide

The label guide is important for narrower labels such as address labels and other specialty labels. The label guide helps keeps the labels aligned properly against the left edge of the label slot so the labels will feed properly.

About Labels

DYMO LabelWriter printers use advanced *thermal* printing technology to print on specially treated, heat-sensitive labels. This means you will never have to replace toner, ink cartridges, or a ribbon to print labels.



DYMO's warranty does not cover malfunction or damage that may be caused by the use of labels other than DYMO-branded labels. Because DYMO LabelWriter printers use thermal printing technology, you must use specially designed and manufactured labels. The thermal coatings used on labels other than DYMO-branded labels may not be compatible, and may provide unsatisfactory printing or cause the printer to malfunction.

How long your labels will last depends on how the labels are used. Thermal paper labels, such as those printed by the LabelWriter printer, are susceptible to fading in two ways:

- Exposure to direct sunlight, to fluorescent light for an extended period of time, or to extreme heat will cause fading.
- Contact with plasticizers (for example, labels placed on plastic ring binders) will cause fading.

In the original packaging, the shelf life for LabelWriter labels is 18 months. When labels are used for short-term applications (envelopes, packages, and so on), fading is not a problem. When labels are used to label files in a file cabinet, fading is very gradual over many years. Labels applied to the edge of a notebook that is then placed on a shelf in the sun will show signs of fading within a few months.

To prolong label life when labels are not in use, store the labels in a cool, dry place and in the black bag in which they were originally packaged.

Ordering Labels

DYMO offers a full range of labels for the LabelWriter printer, including labels suited for addressing envelopes, shipping packages, naming file folders, labeling all sorts of media, printing name badges, and much more. A complete listing can be found at the DYMO Web site: www.dymo.com.



DYMO's warranty does not cover malfunction or damage that may be caused by the use of labels other than DYMO-branded labels. Because DYMO LabelWriter printers use thermal printing technology, you must use specially designed and manufactured labels. The thermal coatings used on labels other than DYMO-branded labels may not be compatible and may provide unsatisfactory printing or cause the printer to malfunction.

Custom Labels (US Only)

DYMO also offers several ways to customize your LabelWriter labels. You can order labels preprinted with text or graphics in any color. For example, shipping labels can be preprinted with your return address and logo to match your corporate letterhead. Labels are also available in custom sizes and with special adhesives.

You can obtain details on our custom label program by calling the Custom Label Sales department at 1-800-426-7827 or visiting <http://customlabels.dymo.com>.

System Requirements

The LabelWriter Wireless label printer requires one of the following:

- Windows® 7 or later
- OS X® 10.11 or later
- iOS® 9 or later
- Android® 5 or later

Designing and Printing Labels

Several options are available for designing and printing labels:

- DYMO Label software
- DYMO Stamps (US Only)
- DYMO Connect

DYMO Label Software

Your label printer works with DYMO Label v.8 software to make designing and printing labels easy. You can also print labels directly from the desktop with QuickPrint, and from Microsoft Word, Excel, Outlook, ACT! (US only), and QuickBooks (US only) with DYMO Label Add-ins. The Add-ins are automatically installed when you install DYMO Label v.8 software if you have the applications above installed on your computer. See the DYMO Label v.8 online Help or Software User Guide for more information on using these features.

See **Printing Labels from a Computer** on page 13.

DYMO Connect Mobile App

With the LabelWriter Wireless label printer you can also design and print labels using the DYMO Connect mobile app available on the Apple® App store or the Google Play™ store.

See **Printing Labels from a Mobile Device** on page 14.

DYMO Stamps (US Only)

To install DYMO Stamps and print USPS postage, sign up for your no-monthly-fee DYMO Stamps account with Endicia.

Go to: <http://www.endicia.com/dymostamps>

At the end of the sign up process, download and install the DYMO Stamps software. Refer to the DYMO Stamps online Help for more information about using the software.



You must have DYMO Label software and your LabelWriter printer installed before installing the DYMO Stamps software.

Developer and SDK Information

DYMO provides various types of information designed to help developers create products that work with the LabelWriter printers and DYMO Label software. Below are some notes for those interested in developing products that work with LabelWriter printers.

- Keep in mind that LabelWriter printers use standard printer drivers. Therefore, printing to a LabelWriter printer is no different than printing to a laser or inkjet printer, except that the pages are smaller.
- In cases where you want to automate printing and take advantage of the label printing power built into DYMO Label software, a Software Developer's Kit

(SDK) is included with the DYMO Label software install. You can get more information, samples, and documentation by downloading our SDK sample install from the SDK page in the Support section on the DYMO web site. support.dymo.com.

Subscribe to the developer's blog at developers.dymo.com for the latest news.

Getting Started

Follow the instructions in this section to set up your label printer to print from your computer. To get started you will:

- 1 Connect the power.
- 2 Load a label roll.
- 3 Connect the printer to your wireless network.
- 4 Install the software you will use to print labels.
- 5 Add the printer to the software on either your computer or mobile device.

Refer to **LabelWriter Wireless Printer Configuration** on page 15 for more advanced printer configuration information.

Connecting the Power

The different LabelWriter printer models may have different power requirements.



Make sure to only use the power adapter that was included with your label printer. See **Technical Specifications** on page 29 for details.

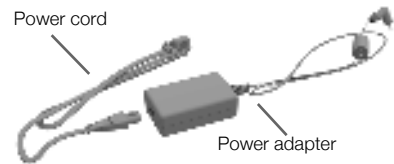

To connect the power

- 1 Plug the power cord into the power adapter and plug the power adapter into the power connector on the back of the printer.
- 2 Plug the other end of the power cord into a power outlet.
- 3 Press  on the side of the printer to turn on the power.

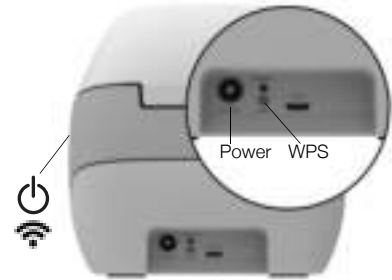

The power status light will flash for a few seconds and the wireless status light will blink.

Loading Labels

Each label roll comes in a black plastic bag. Make sure to store the label roll in this bag when the labels are not being used.

Important!

In order for the labels to feed properly during printing, pay attention to the following when loading labels on the spool and into the printer:

- Make sure the power is turned on.
- The label spool guide must be pushed flush against the label roll, with no gap.
- The labels must be loaded with the left edge of the label inserted against the left edge of the label exit slot.

To load a label roll

- 1 With the printer turned on, press the label reverse feed button to eject the labels that protected the printer during shipment.
- 2 Open the top cover and remove any packing material inside the label compartment.
- 3 Remove the label spool from inside the cover and separate the spool guide from the spindle.

- 4 Hold the spool spindle in your left hand and place the label roll on the spindle so that the labels feed from underneath and the left edge of the label roll is firmly against the side of the spool.
- 5 Slide the spool guide onto the right side of the spool and press the guide tightly against the side of the label roll, **leaving no gap** between the roll and the spool.

To ensure proper feeding of labels during printing, the label roll must fit snugly against both sides of the label spool, with no gaps.

- 6 Insert the label spool into the slot in the printer cover with the labels extending from underneath the roll.
- 7 Align the left edge of the label with the left edge of the label exit slot and insert the label into the slot.

The printer automatically advances the labels, stopping at the beginning of the first label.

If the printer does not feed the labels, make sure the first label is fully inserted and then press the ◀◀ label forward feed button on the side of the printer.

If the first label on the roll is not a full label, press the ◀◀ label forward feed button to eject the partial label.

Regardless of the label width, the left edge of the label must be aligned with the left edge of the label exit slot for the labels to feed properly.

- 8 Slide the label guide to the left until the label guide aligns with the right edge of the label.

Make sure that the label guide does not pinch the label.

- 9 Carefully lower the top cover.

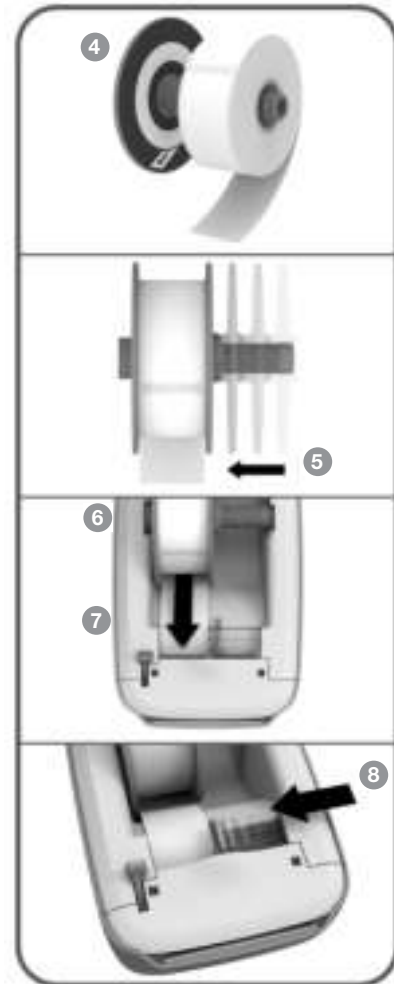

Connecting the Printer to your Wireless Network

Determine the wireless connection method to use to connect the printer to your wireless network. Refer to the documentation that came with your router or access point to determine the connection methods supported.

You can quickly connect the printer to your wireless network in several ways:

- using the Wireless Protected Setup (WPS) button
- using the Quick Setup wizard in the LabelWriter Web Configuration utility installed on the printer

For more advanced configurations, refer to **LabelWriter Wireless Printer Configuration** on page 15.

Connecting the Printer using WPS

If your router supports WPS, you can quickly connect the printer to your secure network without entering the network name and password. Refer to the documentation that came with your router to determine if WPS is supported.

To use the WPS button

- 1 Press the WPS button on the back of the printer.
The wireless status light  on the side of the printer will glow.
- 2 Press the WPS button on your router within two minutes.

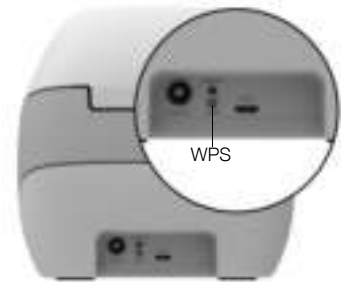

When the printer is successfully connected to your wireless network, the wireless status light is on and no longer glowing.

To connect using a WPS pin code, see **Getting a WPS Pin Code** on page 17.

Connecting the Printer using the Quick Setup Wizard

Make sure you have the password or credentials needed to connect the printer to your wireless network. If you are not sure, contact your wireless network administrator.

If you are connecting the printer to a corporate or enterprise network, contact your wireless network administrator for assistance.

To use the Quick Setup wizard

- 1 After the printer has been turned on for a few seconds, on your computer connect to the wireless network named **DYMOLWWxxxxxx**. This unique printer name can be found on the bottom of the printer.
Your computer has now dropped the connection to your wireless network and established a wireless connection to the printer.
- 2 In your web browser, enter the following URL: **http://192.168.58.1**
The Web Configuration utility will open in your browser displaying the login page.

- 3 Log in to the **LabelWriter Web Configuration** utility using the following:
 - Username: **admin**
 - Password: **admin**
- 4 Follow the wizard to connect the printer to your wireless network.
 - **Printer name** - You have the option of changing the default printer name to something that is more meaningful on your network.
 - **Connection method** - DHCP is recommended. If you choose Static, you will need to have all of the network details to configure the printer on your network.
 - **Wireless network** - Click **Connect** next to the wireless network that you want the printer connected to. See **Connecting to a Wireless Network** on page 16 for more information.

When the printer is successfully connected to your wireless network, the  Wireless status light on the side of the printer is solid on.

- 5 Make a note of the IP address assigned to the printer so that you can access the Web Configuration utility in the future.

Once the printer is connected to your wireless network, your computer's wireless connection to the printer is dropped and your computer should automatically reconnect to your wireless network. If you encounter connection issues, check to make sure your computer has reconnected to your wireless network.

If you experience connection issues, refer to **Wireless Connection Issues** on page 23.

Printing Labels

You can design and print labels using DYMO Label software on your computer or the DYMO Connect app on your mobile device.



Printing Labels from a Computer

To print labels from a computer, you must install DYMO Label software and then add the network printer to your computer.

To print from your computer

- 1 Download and install the latest version of DYMO Label software from support.dymo.com.
- 2 Start DYMO Label software and do one of the following:
 - If this is the first DYMO label printer installed, click **Yes** when prompted by the software to add the label printer as a wireless printer.
 - If a DYMO label printer is already installed, choose **Add Network Printer** from the **File** menu.
- 3 Follow the instructions in the **Add Network Printer** utility.

The LabelWriter Wireless printer should now be the selected printer in DYMO Label software.



Printing Labels from a Mobile Device

You can design and print labels to the LabelWriter Wireless printer from a mobile device using the DYMO Connect mobile app available on the Apple® App store or the Google Play™ store.

To print from a mobile device

- 1 From your mobile device's app store, search for DYMO Connect or use the appropriate QR Code below.



- 2 Install the DYMO Connect app.
- 3 Tap  to open the app and select the LabelWriter Wireless printer.

Refer to **Wireless Connection Issues** on page 23 if you have problems connecting to the printer.

Connecting the Printer using a USB Cable

If you do not want your printer on your wireless network, you can connect the printer directly to your computer using a USB cable. Use only a DYMO USB cable with part number 1997364, available from Customer Support if you do not already have one.



Do not connect the printer to your computer until after the software installation is complete.

To connect to your printer directly from your computer

- 1 Download and install the latest version of DYMO Label software from support.dymo.com.
- 2 At the end of the installation, connect the printer to your computer.
 - Plug the USB cable into the USB port on the back of the printer.
 - Plug the other end of the cable into an available USB port on your computer.
- 3 Start DYMO Label software.
- 4 Select the LabelWriter Wireless printer named **DYMO LabelWriter Wireless**.

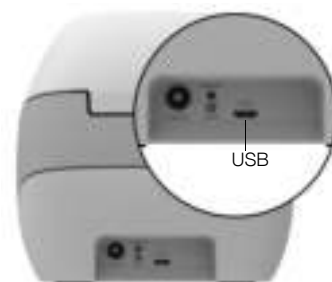

LabelWriter Wireless Printer Configuration

The LabelWriter Wireless printer includes a Web Configuration utility that allows you to configure the printer on your network and view the printer's status.

Recommended Browsers

For the best experience, use the latest versions of the following browsers when starting the LabelWriter Web Configuration utility:

- Internet Explorer version 10 or later
- Chrome version 35 or later
- Firefox version 36 or later
- Safari version 10 or later
- Edge version 12 or later
- Opera version 20 or later

Accessing the Web Configuration Utility

Once the printer is connected to your wireless network, you can access the Web Configuration utility on the printer using the IP address assigned to the printer by your network.

If you have not yet set this printer up on your wireless network, see **Connecting the Printer to your Wireless Network** on page 12.

To start the Web Configuration utility

- 1 In your browser, enter the URL assigned to the printer during setup.
If this is the first time you are accessing the printer, the default URL is:
http://192.168.58.1
- 2 Log in to the **LabelWriter Web Configuration** utility using the following:
 - Username: **admin**
 - Password: **admin** or the custom password you have assigned



The printer status page appears showing the current wireless status of the printer.

Web Configuration Menu

To access the Web Configuration menu, click  in the upper left corner of any page in the Web Configuration utility. From the menu, you can:

- Run the **Quick Setup** wizard to connect to a wireless network.
- View the **Status** of the printer
- Change the **Printer Name**
- Select a new **Wireless Connection**
- Configure the printer's **Access Point**
- Configure a static **Wireless** connection
- Change the **Password**
- Change the **Language**
- Set the session **Timeout**
- **Restart** the printer

Running the Quick Setup Wizard

The first time you connect to the LabelWriter Wireless printer, a Quick Setup wizard guides you through the connection process. You can re-run this Quick Setup wizard at any time from the  menu to connect to a different network. You can also skip the Quick Setup wizard and configure the printer for a network manually from the  menu. See **Connecting to a Wireless Network**.

Connecting to a Wireless Network

The Web Configuration utility allows you more options for connecting the printer to a wireless network, such as accessing a hidden network or a more advanced configuration.

The wireless security methods supported are:

- Open
- WEP
- WPA/WPA2 - Personal Mixed
- WPA2 - Personal
- WPA/WPA2 - Enterprise Mixed
- WPA2 - Enterprise

 X.509 certificates in PEM and DER formats are supported. PFX certificates must be converted to PEM/DER.

The information in this section assumes that you have the network name, authentication, and other network details available. If you don't have this information, contact your network system administrator.

To connect the printer to a visible wireless network

- 1 Log in to the Web Configuration utility.
See **Accessing the Web Configuration Utility** on page 15.
- 2 From the  menu, click **Wireless connection**.

- 3 Click **Connect** next to the wireless network name you want to connect to.
If your network is not listed, see the instructions below to add a network manually.
- 4 Enter the required information and click **Connect**.

To manually configure a hidden wireless network

- 1 Log in to the Web Configuration utility.
See **Accessing the Web Configuration Utility** on page 15.
- 2 From the  menu, click **Wireless connection**.
- 3 Click **Add network**.
- 4 Enter the network details and click **Connect**.

Getting a WPS Pin Code

Some router models support WPS but require a pin code.

To connect using a WPS pin code

- 1 Log in to the Web Configuration utility.
See **Accessing the Web Configuration Utility** on page 15.
- 2 From the  menu, click **WPS**.
- 3 Click **Get pin code**.
A unique 8-digit pin code displays, the wireless status light will blink, and a two minute count down begins showing the time you have to connect the printer to your router.
- 4 Enter the pin code in your router's settings within the time left to connect.
Refer to your router's documentation for where to enter the pin code.

Managing the Printer's Access Point

The LabelWriter Wireless printer can be its own access point, sometimes referred to as a 'hotspot', allowing a direct wireless connection between the printer and your computer. In access point mode, you can wirelessly connect and print to the printer from your computer without connecting to an existing wireless network.

Out of the box, the printer's access point is turned on. However, after you connect the printer to a wireless network, access point mode is turned off. You can turn access point mode on and off through the LabelWriter Wireless Advanced Options within DYMO Label software.

To turn on the printer's access point

- 1 Connect the printer to your computer with a USB cable.
- 2 From within DYMO Label software, select the LabelWriter Wireless printer.

- 3 Click the  icon next to the printer.
The LabelWriter Wireless Advanced options dialog box appears.



- 4 Select **Access Point** and click **X** to close the dialog box.

The printer is now in access point mode and can be accessed wirelessly from your computer.

To configure the printer's access point

- 1 Connect to the wireless network named **DYMOLWWxxxxxx**. This unique printer name can be found on the bottom of the printer. However, the name may have been changed during initial setup.

Your computer has now dropped the connection to your wireless network and established a wireless connection to the printer.

- 2 In your web browser, enter the following URL: **http://192.168.58.1** or the url assigned during initial setup.

The Web Configuration utility will open in your browser displaying the login page.

- 3 Log in to the **LabelWriter Web Configuration** utility using the following:
 - Username: **admin**
 - Password: **admin** (or a custom password that you have assigned)

- 4 From the  menu, click **IP Configuration>Access Point**.

The Access Point page displays.

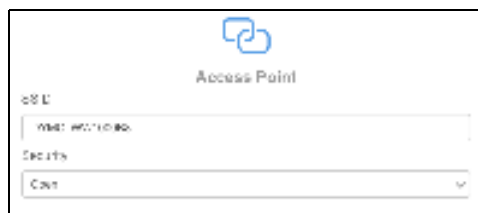

- 5 Select the security method, enter the authentication details, and click **Save**.

If you are currently connected to the printer in access point mode, the connection will be lost.

 Configuring the printer's access point does not turn on the access point. You can only turn on the access point through DYMO Label Software.

Connecting the Printer to a Different Network

When moving the printer to a new wireless network, you will need to connect the printer to that new network. You can do this in several ways:

- Using the WPS button. See **Connecting the Printer using WPS** on page 12.
- Resetting the printer to factory default settings by pressing the RESET button on the back of the printer and then using the Quick Setup wizard. See

Connecting the Printer using the Quick Setup Wizard on page 12.

- From your computer, connecting to the printer in access point mode and using the Web Configuration utility on the printer. See the instructions below.

 You will need to connect the printer to the new network each time you move the printer. The printer does not 'remember' networks it was previously connected to.

To use the Web Configuration utility to connect to a new network

- 1 Move the printer to the new location.
- 2 If not already on, turn on the printer's access point.
Refer to **Managing the Printer's Access Point** on page 17.
- 3 Connect to the wireless network named **DYMOLWWxxxxxx** (or the name you have previously assigned to the printer).
- 4 From your browser, open the Web Configuration utility by entering:
http://192.168.58.1
 - Username: **admin**
 - Password: **admin** (or a custom password that you have assigned)
- 5 Select **Wireless connection** from the  menu.
- 6 Select the network you wish to add the printer to and click **Connect**.

The printer is now available on the new network.

Changing the Settings

Several of the LabelWriter Web Configuration settings can be changed. You can change the password, rename the printer, change the language, or change the session timeout.

Changing the Password

For security reasons, we recommend that you change the password for accessing the LabelWriter Web Configuration utility. You cannot change the user name.

To change the password

- 1 Log in to the Web Configuration utility.
See **Accessing the Web Configuration Utility** on page 15.
- 2 From the  menu, select **Password**.
- 3 Enter a new password and click **Save**.

 If you forget your password, you will need to reset the printer to factory default settings to use the password that shipped with the printer. See **Resetting the Printer to Factory Default Settings** on page 27.

Renaming the Printer

If you have multiple printers on your network, you may want to rename the printer to something that is more meaningful to your environment.

The printer name can be between 4 and 32 alphanumeric characters with no spaces.

To rename the printer

- 1 Log in to the Web Configuration utility.
See **Accessing the Web Configuration Utility** on page 15.
- 2 From the  menu, select **Printer name**.
- 3 Enter a new name for the printer and click **Save**.

Changing the Language

The default language for the Web Configuration utility is English. When you change the language, that language will be remembered the next time you log in to the utility.

To change the language

- 1 Log in to the Web Configuration utility.
See **Accessing the Web Configuration Utility** on page 15.
- 2 From the  menu, select **More>Language**.
- 3 Select the desired language and click **Save**.

Changing the Session Timeout

A Web Configuration utility session will end after 15 minutes of inactivity and you will have to log in again. You can change the amount of time before a session ends but the time should not be less than 10 minutes.

To rename the printer

- 1 Log in to the Web Configuration utility.
See **Accessing the Web Configuration Utility** on page 15.
- 2 From the  menu, select **More>Timeout**.
- 3 Select and click **Save**.

Caring for Your Printer

The LabelWriter printer is designed to give you long and trouble-free service, while requiring very little maintenance. You will get the best possible performance from your LabelWriter printer if you follow the setup instructions that appear in **Getting Started on page 10**, and the cleaning procedures described in this section.

To keep your LabelWriter printer working properly, you should clean it from time to time. Dusting the outside of the printer occasionally will help keep foreign matter from getting inside the printer. However, it is still a good idea to periodically perform some basic interior maintenance, such as cleaning the label path with a LabelWriter cleaning card (available from www.dymo.com).

You can easily clean your LabelWriter printer using the following items:

- Lint-free cloth.
- Diluted dishwashing detergent or diluted glass cleaner.
If you use glass cleaner, make sure it does not contain ammonia.
- Small, soft brush, such as a tooth brush or child's paint brush.
- LabelWriter cleaning card to clean the print head.
To purchase cleaning cards, visit www.dymo.com.

To clean the exterior of your printer and the label roll compartment

- 1 Remove the roll of labels.
- 2 Turn the power off and disconnect the power cord.
- 3 Use the lint-free cloth to wipe the exterior of the printer.
- 4 Remove dirt and smudges with one of the cleaning solutions mentioned above.
- 5 Lift the top cover.
- 6 Use a small, soft brush or cotton swab to whisk away paper dust and other stray particles from the inside of the printer.
- 7 Reconnect the power cord and turn on the printer.
- 8 If you have a LabelWriter cleaning card, follow the instructions printed on cleaning card packaging. If you do not have a cleaning card, contact DYMO Customer Support at www.dymo.com.
- 9 Reload the roll of labels and carefully close the top cover.

Getting Help

Your LabelWriter printer should offer years of trouble-free printing with very little maintenance. However, in the event that you encounter a problem, this chapter offers suggestions for resolving problems that can occur when using the printer. If you are unable to solve a problem, this chapter also describes how to contact DYMO [Customer Support](#).

This section provides information on how to detect and correct problems you might encounter while using your LabelWriter printer.

- **Wireless Status Light**
- **Power Status Light**
- **Wireless Connection Issues**
- **Printer Issues**
- **Resetting the Printer to Factory Default Settings**
- **Obtaining Customer Support**

Wireless Status Light

On LabelWriter Wireless printers, the wireless status light visually shows the current state of the printer:

Status Light	Description
Off	No wireless network connection or printer is in power saving mode. Doesn't apply to Access Point mode.
Solid on	Wireless network connection. Doesn't apply to Access Point mode.
Slow blinking	Attempting to connect to a wireless network.
Glowing	Attempting to connect using WPS (two minutes).
Fast blinking	Error. See Wireless Connection Issues on page 23.

Power Status Light

The power status light visually shows the current state of the printer:

Status Light	Description
Off	Power is off.
Solid on	Power is on and printer is ready.
Glowing	Printer is in power saving mode.
Fast blinking	An error occurred. This can occur because the labels are missing or due to some other error condition. Refer to some possible solutions later in this chapter.

Wireless Connection Issues

The following are solutions to some common questions about connecting to the printer on your wireless network.

General Connection Guidelines

Many times issues you may have while trying to connect to the printer can be solved very easily. Check the following:

- Make sure the printer is turned on.
- Make sure your router is turned on and the wireless network is operational.
- Make sure the printer is connected to the same wireless network as your computer or mobile device.
- Restart your mobile device.
- Make sure the printer is not connected to a guest or public wireless network, as these types of networks have additional restrictions that can cause problems.
- Move the printer closer to your wireless router. The printer works best when there are no obstructions between the printer and your router. The closer the printer is to the router the better.
- Make sure any firewall or security programs on your computer are not blocking communications between the printer and your computer.
- Make sure you are not connected to a Virtual Private Network (VPN).

The Printer Does Not Show Up in My Wireless Network List

- Make sure the printer is turned on.
- Make sure you are not connected to a Virtual Private Network (VPN).
- Refresh the list of available networks by turning Wi-Fi off and then on again on your computer or mobile device.

Unable to Connect to the Web Configuration Utility on the Printer

The printer's IP address may have been reassigned. This is normal behavior with a DHCP connection when the printer has been turned off for a period of time. The printer's IP address will be reassigned the next time the power is turned on and the printer appears on the network.

You can determine the printer's current IP address by accessing the DHCP client list through your router's web pages. Refer to the documentation that came with your router for more information.



In some environments, you may be able to connect to the printer using the mDNS name: **http://DYMOLWWxxxxxx.local**.

How Do I Move my Printer to a Different Wireless Network

The easiest way to connect to a new network is to reset the printer to factory default settings and run the Quick Setup wizard. All previous settings including language, password, session time out, and so on, will be lost. See **Resetting the Printer to Factory Default Settings** on page 27.

Otherwise, you can follow the instructions in **Connecting the Printer to a Different Network** on page 18 to connect to a different network without losing your settings.

Printer Shows Not Connected in the DYMO Connect App

After a period of idle time, the wireless connection between your printer and mobile device may drop. You will need to reconnect to the LabelWriter Wireless printer from within DYMO Connect.

If you still cannot connect to the printer, check the following:

- Make sure you are connected to the right printer.
- Close (force quit) the DYMO Connect app and restart it.
- Turn airplane mode on and then off.
- Restart the mobile device.

Printer does not show up in DYMO Connect

The LabelWriter Wireless does not show up in the printer selection page in DYMO Connect.

- Close (force quit) the DYMO Connect app and restart it.
- Restart the mobile device.
- Make sure you are not on a public or guest network.

Unable to Connect To or Select the Printer in DYMO Label Software

- Make sure the printer and the computer you are using are on the same wireless network.
- Make sure the printer is turned on and ready to print.
- Add the printer from **File>Add Network Printer** in DYMO Label software and then restart DYMO Label software.

Printer Issues

The following are solutions to some common issues you may encounter while working with the label printer.

Power Status Light Flashing

If the power status light is flashing, the problem could be one of the following:

Problem	Solution
No labels	The label roll is out of labels or there is no label roll inserted. Always use authentic DYMO labels.
Overheated print head	Turn the printer off and wait 3-5 minutes before turning the printer on again.
System error	Turn the printer off and then on again. If none of the other issues above correct the problem and the light is still flashing, contact Customer Support.

Clearing Label Jams

To clear labels that have become jammed in the printer

- 1 Tear off any labels that have already fed through the printer.
- 2 Press the label release lever forward and pull the jammed label out of the label exit slot.

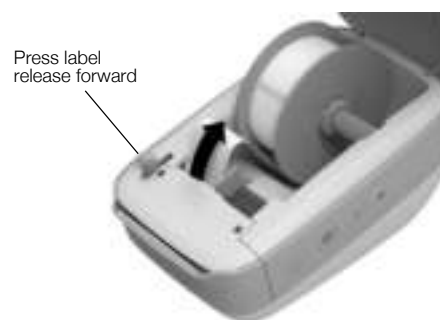

Correcting Poor Print Quality

Poor print quality is most frequently caused by one of the following:

- An old roll of labels
- Labels made by a manufacturer other than DYMO
- Labels where the thermal coating has been compromised
- A dirty print head

First, make sure you are using DYMO-branded labels. Do not use third-party labels because the thermal coating on other labels has a different sensitivity than DYMO-branded labels. Also, the perforated holes between the labels made by other manufacturers are frequently not detectable by LabelWriter printers.

If the print quality becomes faint, small dots of white appear scattered through the printed characters, or light and dark patches of printing appear, you are probably using a faulty roll of labels. Try using a different roll from a fresh box. If the second roll prints correctly, the problem is with the first roll of labels.

Another possibility is that the LabelWriter print head needs cleaning. See **Caring for Your Printer** on page 21 for information about cleaning the label path with a LabelWriter cleaning card.

Labels Do Not Feed Correctly

If your labels do not feed correctly, check the following:

- Make sure your labels are loaded properly and that the left edge of the label is aligned with the left edge of the label exit slot. See **Loading Labels** on page 10.
- Make sure you are using authentic DYMO labels. The perforated holes between the labels made by other manufacturers are frequently not detectable by DYMO printers. When the perforations are not detected, the labels will not feed correctly. Using third-party labels may also void your warranty.

Printer Does Not Print or Stops Printing

If your printer does not print or stops printing while in use, follow the steps below to track down the problem.

- 1 Make sure the printer is still getting power and that the power cable has not been disconnected.
If the power status light on the side of the printer is not lit, check to make sure the power cable is plugged in, and that your power strip is working.
To make sure the problem is not with the outlet or power strip, try plugging something else into the wall outlet and power strip.
Make sure you are using the power adapter and cable that came with your printer. Power adapters from older LabelWriter printers may not be compatible with the LabelWriter Wireless printer.
- 2 Confirm that the printer is feeding labels properly by pushing the ◀ label forward feed button while the printer is on.
If the labels are jammed, the power status light will blink. Refer to **Clearing Label Jams** on page 25.
- 3 Make sure that your USB cable has not come loose from the back of your printer or from your computer.
Refer to the installation instructions in the *Quick Start Guide* to make sure the cable is connected properly.
- 4 (Windows) Check that your LabelWriter printer driver is installed correctly.
The LabelWriter printer driver takes print data from your software and directs it to the LabelWriter printer. The driver is automatically installed when you install the DYMO Label software. However, the driver may have been changed or deleted by mistake.
 - a From the Windows menu, choose **Devices and Printers**.
 - b Right-click the LabelWriter printer icon, and then choose **Printer Properties**.
 - c From the Properties dialog box, click **Printing Preferences**.
 - d From the Preferences dialog box, click **Advanced**.The Advanced dialog box appears.
If no errors are displayed in the Advanced dialog box, the printer driver is installed correctly.

Performing a Printer Self-Test

If you experience problems with broken characters or other print quality issues, perform a printer self-test. The self-test verifies that all elements of the print head and printing mechanism are in working condition.

To perform a self-test

- 1 With a roll of labels in the printer, press and hold the ◀ label forward feed button for at least three seconds.

The printer begins printing vertical lines along the width of the printer. The test pattern automatically changes every 3/4 inch (19 mm).

- 2 Once the self-test begins, release the label feed button.
- 3 To stop the self-test, press and release the ◀ label forward feed button or the  power button.

If you are still having problems after checking the above items, contact Customer Support. See **Obtaining Customer Support** on page 27.

Resetting the Printer to Factory Default Settings

An easy way to move the LabelWriter Wireless printer to a new network is to reset the printer to factory default settings. This reset will delete any custom settings you may have entered in the Web Configuration utility such as printer name, password, language, and so on.

To reset the printer to factory default settings

- 1 Make sure the power is turned on.
If you just pressed the power button, wait for about 30 seconds for the printer to fully start up.
- 2 Using a pointed non-metal tool, press and hold the RESET button on the back of the printer for at least five seconds.
- 3 After five seconds, release the RESET button to begin the printer reset.

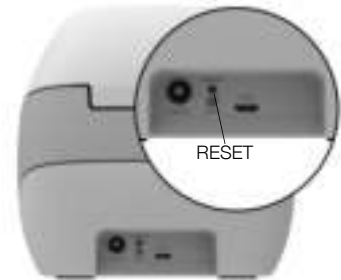

After about 30 seconds, you will be able to connect the printer to a wireless network as described in **Connecting the Printer to your Wireless Network** on page 12.

Obtaining Customer Support

If you experience problems with the setup or use of your printer, carefully read this user guide to make sure you have not missed something that is covered in the documentation.

If you cannot resolve your problem by consulting the documentation, you can obtain additional information and assistance from DYMO.

DYMO maintains an Internet Web site at www.dymo.com that includes the latest support information for your LabelWriter printer.

To contact us, visit the Support area of our Web site at: support.dymo.com

Documentation Feedback

We are constantly working to produce the highest quality documentation for our products. We welcome your feedback.

Send us your comments or suggestions about our user guides. Please include the following information with your feedback:

- Product name, model number, and User Guide page number
- Brief description of instructions that are inaccurate or unclear, areas where more detail is needed, and so on

We also welcome your suggestions about additional topics you would like to see covered in the documentation.

Send email messages to: **dymo.docfeedback@newellco.com**

Please keep in mind that this email address is only for documentation feedback. If you have a technical question, contact Customer Support at support.dymo.com.

Technical and Environmental Information

This chapter contains technical and certification information for the LabelWriter Wireless printer.

Technical Specifications

	LabelWriter Wireless
Print Method	Direct Thermal
Print Resolution	300 dpi (normal) 600 x 300 dpi (graphics)
Print Speed (labels/min for address label in text mode)	Up to 71 four-line address labels per minute (Printing over Wi-Fi may impact the number of labels per minute)
Maximum Print Width	2.25 in (56 mm)
Maximum Media Width	2.44 in (62 mm)
USB Interface	USB 2.0 Full speed Printer Class Device
USB Connector Type	USB 2.0 Micro – Type B
Wireless Interface	Wi-Fi (IEEE 802.11a/b/g/n) 2.4 GHz + 5 GHz Frequency bands / Maximum radio-frequency power for EU: 2400–2483.5 MHz / less than 10dBm; 5150–5350 MHz and 5470–5725 MHz / less than 15dBm
Dimensions (WHD)	5 in (127 mm) x 4.9 in (124 mm) x 7.95 in (202 mm)
Weight	1.45 pounds (0.66 kg) (printer and spool only)
Printer Power Requirements	24 VDC 2.5 A
Power Adapter	Adapter model DYS602-240250W from Dongguan Dongsong Electronic Co., Ltd.
Rated Duty Cycle	1000 shipping labels per hour
Regulatory Approvals	CE, FCC, IC, CB, GS, and RCM
Warranty	Two Year Limited

Wireless Specifications

Station Mode

Network Standard	802.11a/b/g/n
Supported bands	2.4 GHz; 5 GHz
Channel Bandwidth	20 MHz

Access Point Mode

Network Standard	802.11b/g/n
Supported band	2.4 GHz
Channel Bandwidth	20 MHz

Device Certification

This device has been tested and complies with the requirements of:

- CB Certificate
- GS Certificate
- CE Mark
- FCC Part 15
- ICES-003, RSS-210 and RSS-Gen
- RCM
- RoHS directive 2011/65/EU

This device is not intended for use in the direct field of view at visual display workplaces. To avoid incommoding reflections at visual display workplaces, this device must not be placed in the direct field of view.

EU DECLARATION OF CONFORMITY

Radio Equipment

Producer: Label maker
 Type: LabelWriter Wireless

Manufacturer

Name: NWI Belgium Services b.v.b.a
 Address: Industriepark-Noord 30, B100 Sint-Niklaas, Belgium
 Country: Belgium

This declaration of conformity is issued under the sole responsibility of the manufacturer:

Object of the declaration:



The object of the declaration described above is in conformity with the following relevant Union harmonized or legislation(s):

Radio Equipment Directive (RED) 2014/53/EU

Product Name: Label maker
 Model No.: LabelWriter Wireless
 Adapter Model No.: DYS602-240250W

Conformity to the essential requirements of the legislation(s) have been demonstrated by using the following standards:

Health and Safety (Art. 3(1)(a)): EN 60950-1: 2006 + A11: 2009 + A1: 2010 + A12: 2011 + A2: 2013
 EN 62311: 2008

EMC (Art. 3(1)(b)): EN 55032:2015, EN 55024: 2010+A1: 2015, EN 61000-3-2: 2014, EN 61000-3-3: 2013
 Draft EN 301 489-1 V2.2.0 (2017-03), Draft EN 301 489-17 V3.2.0 (2017-03)

Spectrum (Art. 3(2)): EN 300 328 V2.1.1 (2016-11), EN 301 893 V2.1.1 (Clause 4.2.8 Receiver Blocking only), EN 301 893 V1.6.1 (2016-03)

Specific Requirements (art. 3.3 a-1)

Standards for other legislations

The notified body TÜV Rheinland LGA Products GmbH, Nürnberg, 0197 performed an EU-type examination and issued the EU-type examination certificate: RT 80122127 0001.

The following accessories and components, including software, allow the object of the declaration described above to operate as intended and in conformity with this EU declaration of conformity:

Accessory Name	Manufacturer	Brand	Model Name
Adapter	Dongguan Dongsong Electronic Co., Ltd.	DYS	DYS602-240250W
AC power cable	Longwell Company	Longwell	PE8GVZ1B90A 02B; PE8GVXLB90AA02B

USB cable	Jia Tai Chen Electronics Co., Ltd		JTC-USB CABLE-001
<p>Signed for and on behalf of: <u>NWL Belgium Services b.v.a.</u> Place and date of issue: <u>Sint-Niklaas, Belgium, 07-27-2017</u></p> <p>Signature: </p> <p>Name, function: <u>Benny Suy, Sr. Regulatory & Compliance Manager</u></p>			