

VOORBEREIDINGEN

1

Open achterkant met nagel via de inkeping

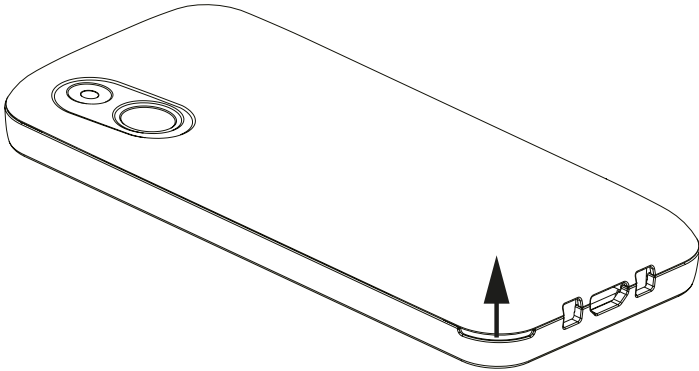

2

Haal achterkant eraf

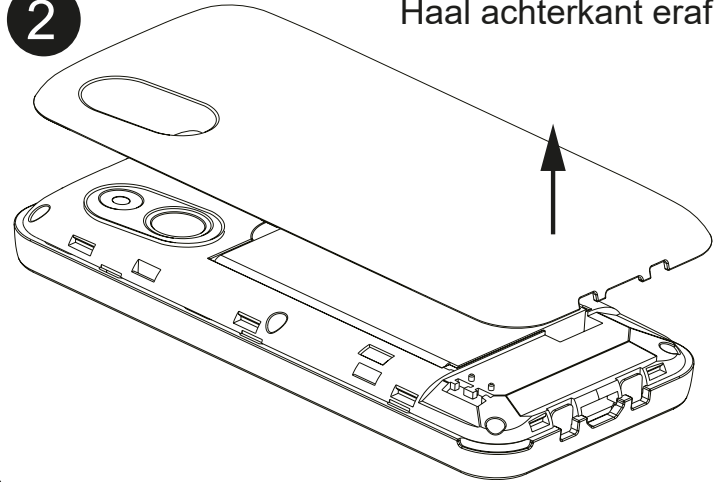

3

Kies Mini SIM

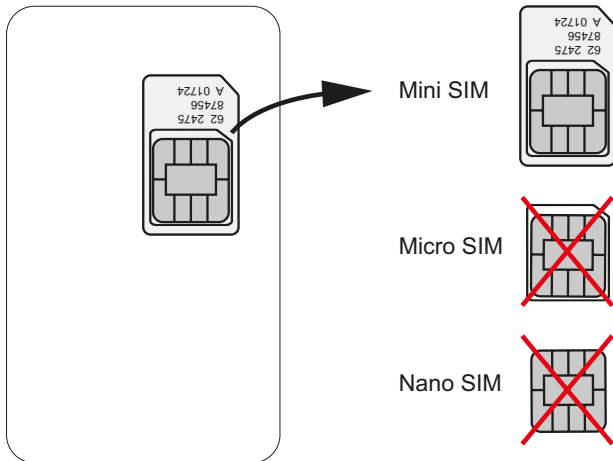

4

Schuif de Mini SIM onder het metalen beugeltje

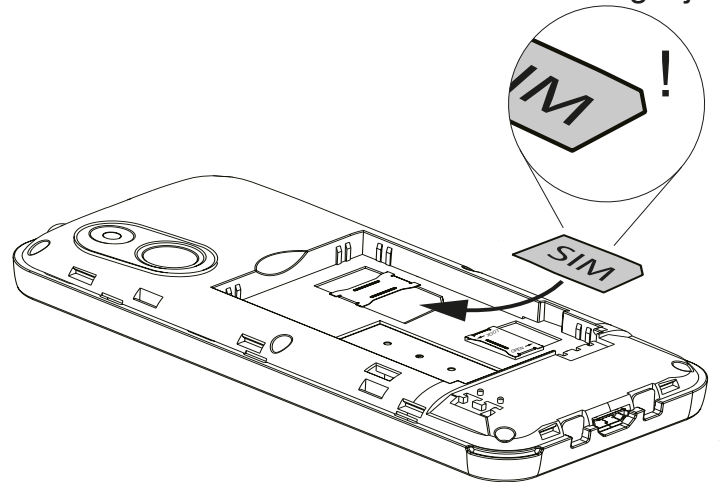

5

Schuif SD-kaart slot open indien u gebruik maakt van een SD-kaart

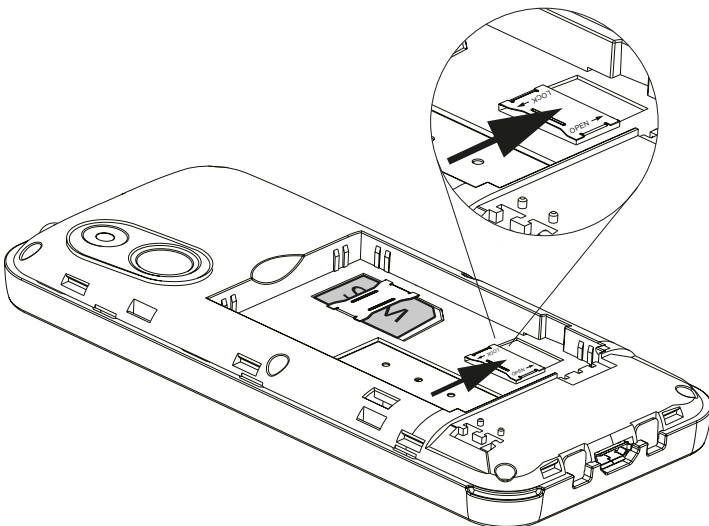

6

Open SD-kaart slot indien u gebruik maakt van een SD-kaart

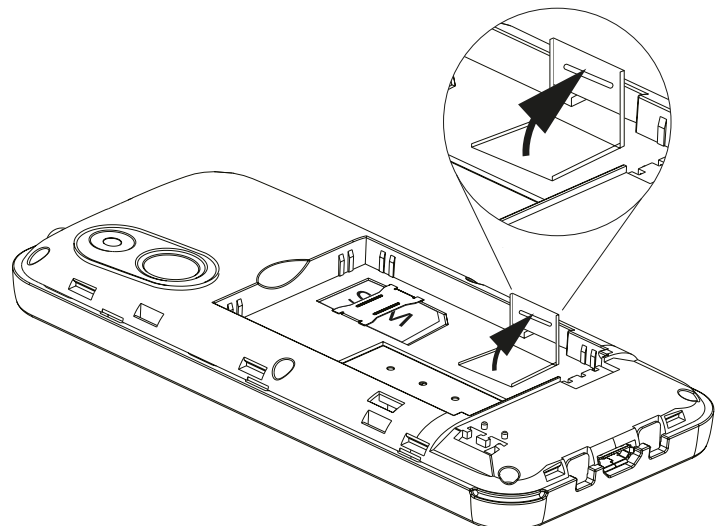

7

Plaats micro SD-kaart indien u deze wilt gebruiken

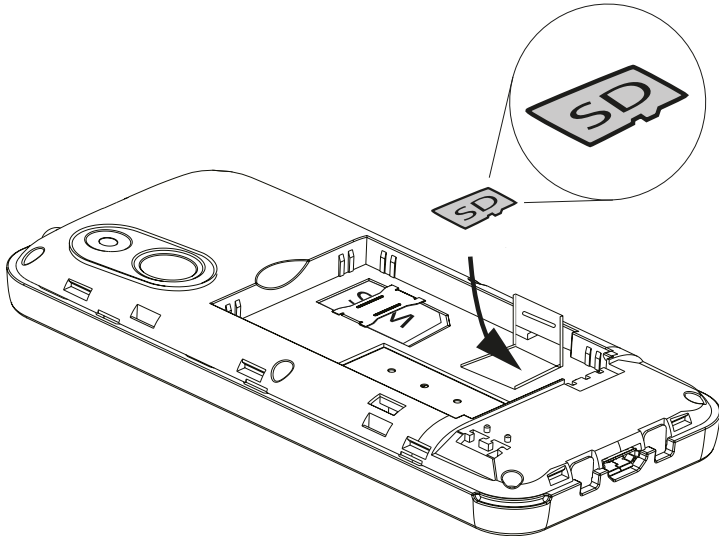

8

Schuif SD-kaart slot dicht

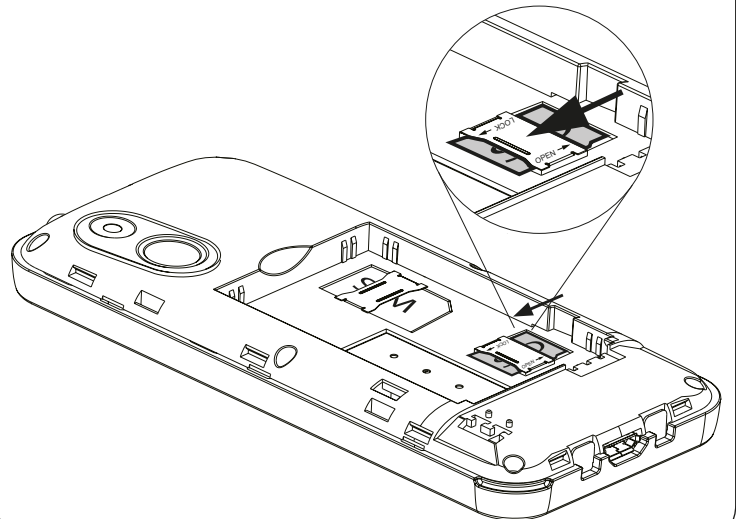

9

Plaats de batterij met + en - naar boven gericht

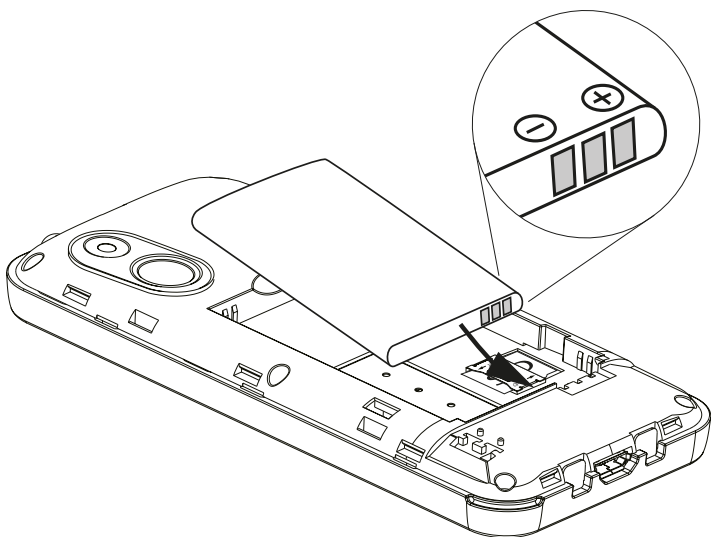

10

Plaats achterkant weer op de telefoon

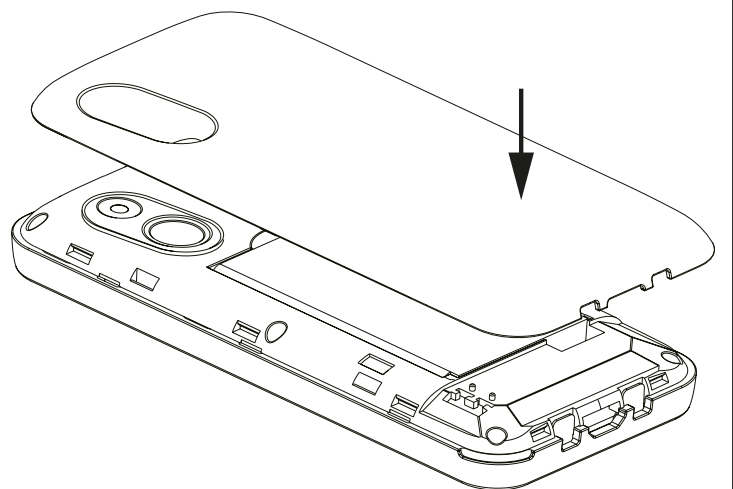

11

Druk venster uit sjabloon en knip de foto van een contactpersoon op maat

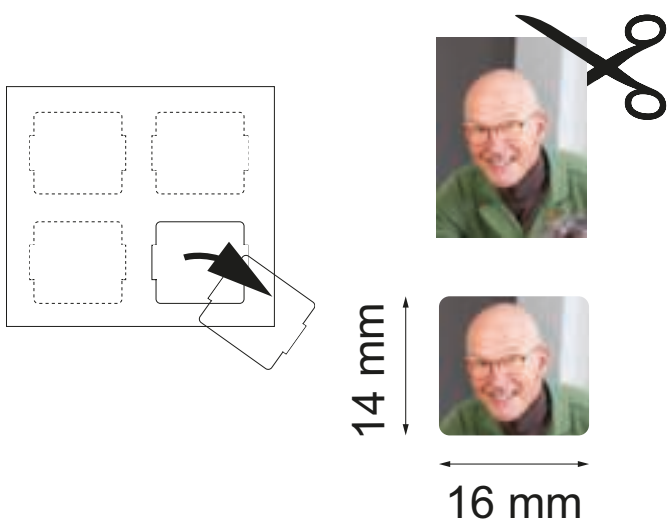

12

Plaats foto en venster in foto-toets

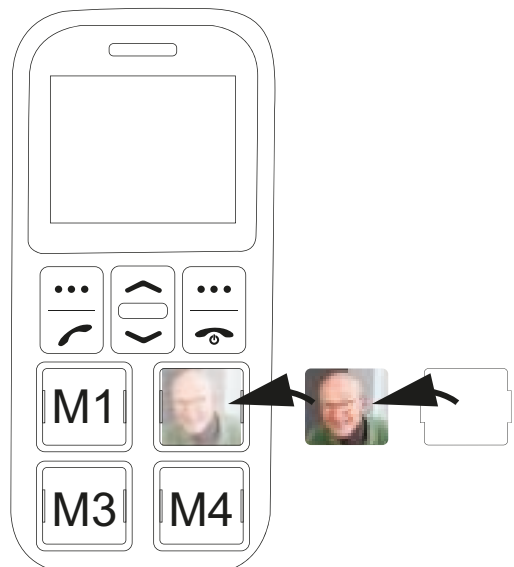

INSCHAKELEN EN BASIS INSTELLINGEN

13

Druk 3 seconden op rode hoortje

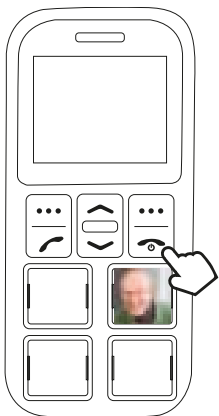

Bij een nieuwe installatie van de SIM-kaart is deze beveiligd met een 4 cijferige pincode

3 sec.

Druk op toets rechtsonder

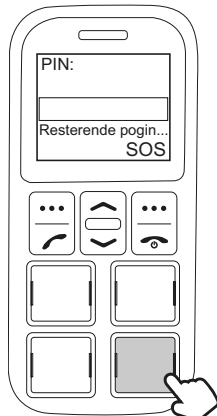

Kies met pijltjes-toetsen het cijfer

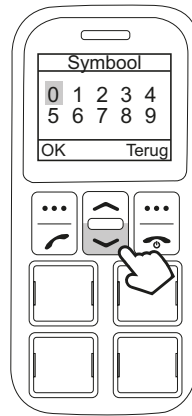

Druk op toets [OK]

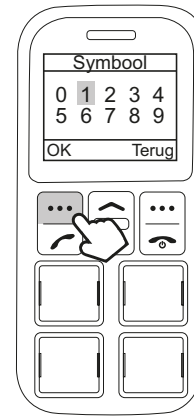

Druk op toets [OK]



Kies uw taal met pijltjestoetsen



Druk op toets [OK]

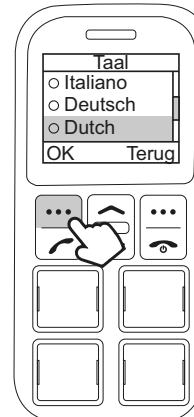

Herhaal vorige 3 stappen tot pincode compleet is ingevoerd



Selecteer eenmalig de taalkeuze



CONTACT TOEVOEGEN

14

Ga naar het telefoonboek

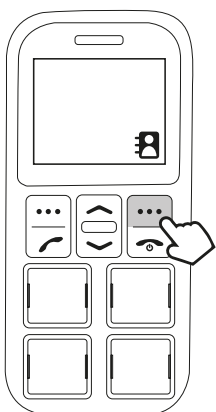

Kies met pijltje [Nieuw contact]

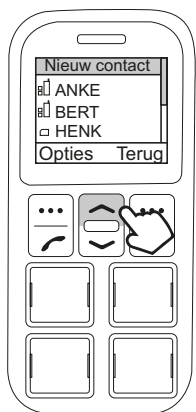

Druk op toets [Opties]

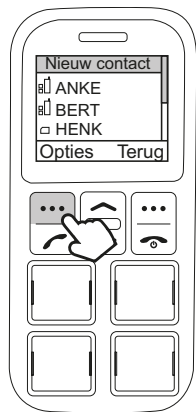

Druk op toets [OK]

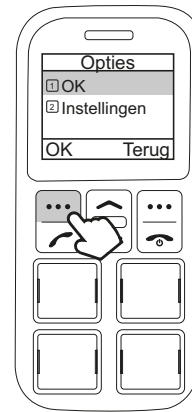

Kies via pijltje [Naar sim] of [Naar telefoon]

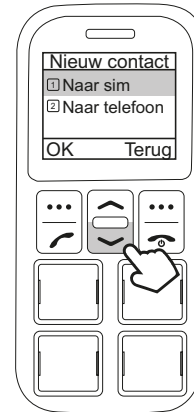

Toets [OK]

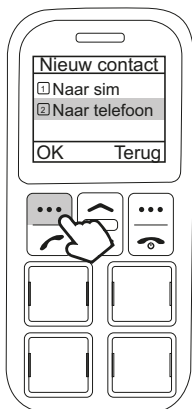

Druk op 1 van de 4 foto-toetsen

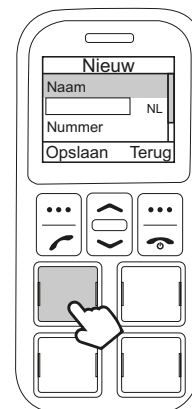

Kies met pijltjes toetsen een letter

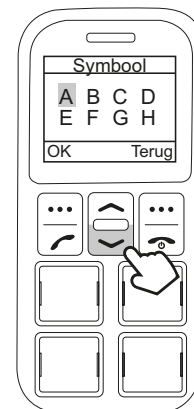

Voer vervolgens de naam in m.b.v de 4 foto-toetsen

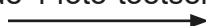

M1: letter A t/m H
M2: letter I t/m Q
M3: letter R t/m Z
M4: cijfer 0 t/m 9

VERVOLG CONTACT TOEVOEGEN

Druk op toets [OK]

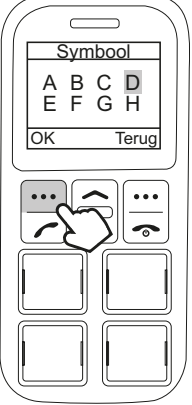

Herhaal vorige 3 stappen tot naam compleet is ingevoerd



Voer vervolgens telefoonnummer in



Ga met pijltjestoets naar [Nummer]

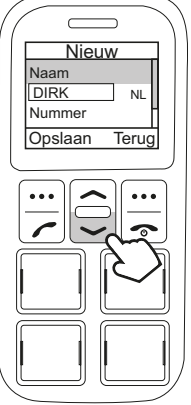

Druk op toets rechtsonder

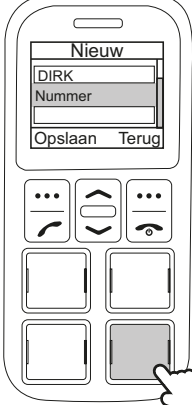

Kies met pijltjestoetsen een cijfer

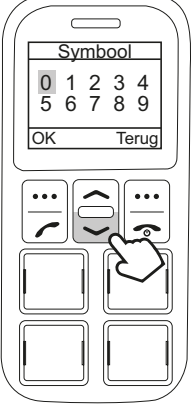

Druk op toets [OK]

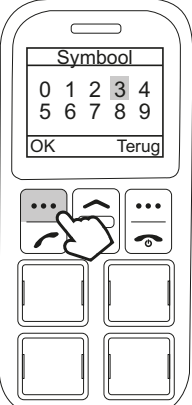

Herhaal vorige 3 stappen tot telefoonnummer compleet is ingevoerd



Druk op toets [Opslaan]

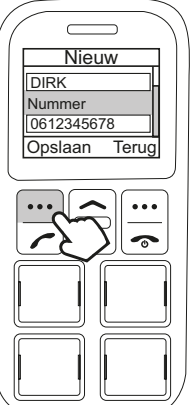

Letter of cijfer verkeerd ingetoetst?



Druk op toets [Wissen]

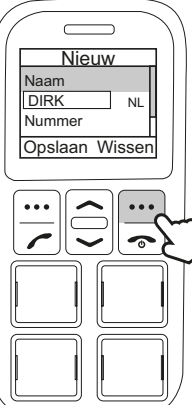

INSTELLEN GEHEUGEN TOETSEN

15

Kies contact via de pijltjestoetsen

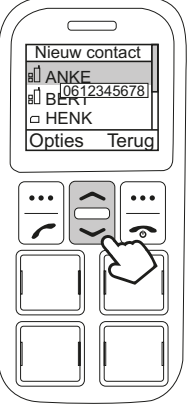

Druk op toets [Opties]

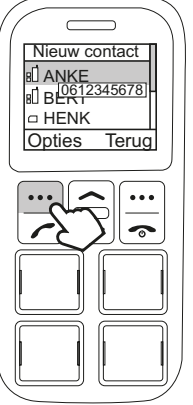

Kies via de pijltjes [M1-M2-M3-M4]



Druk op toets [OK]

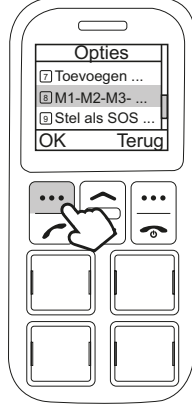

Kies via de pijltjes 1, 2, 3 of 4

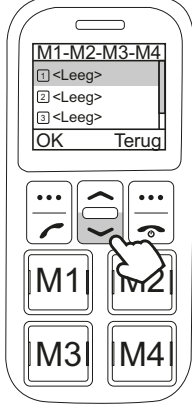

Druk op toets [OK]

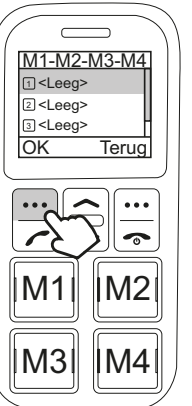

Druk op toets [Opties]

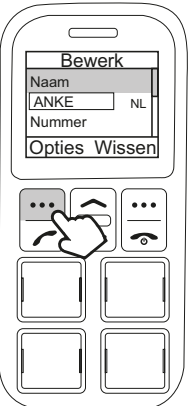

Druk op toets [Opslaan]

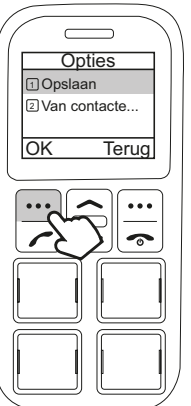

CONTACT BELLEN VIA TELEFOONBOEK

16

Ga naar het telefoonboek

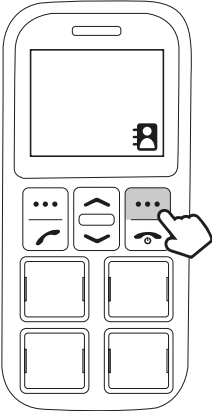

Kies contact via pijltjestoetsen

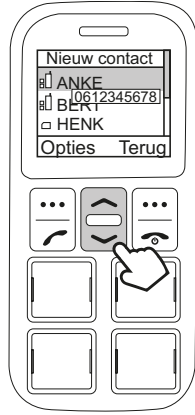

Druk op het groene hoortje

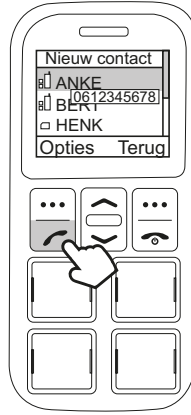

Toestel is bezig met bellen

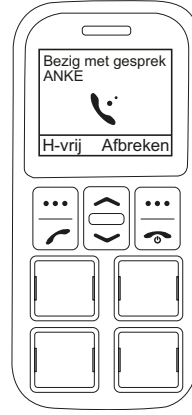

BELLEN VIA GEHEUGEN TOETSEN

17

Druk op toets M1, M2 etc.

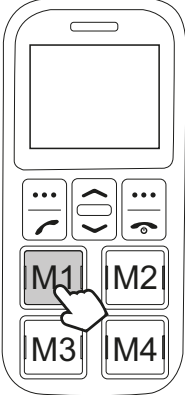

Druk op toets [Bellen]

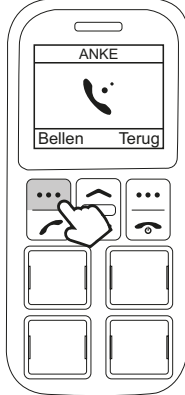

Toestel is bezig met bellen

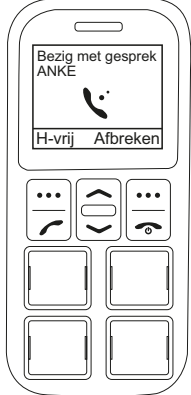

SLAAPSTAND VAN DE TELEFOON

18

Is het scherm zwart geworden?

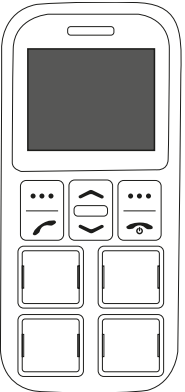

Druk 1x op een willekeurige toets

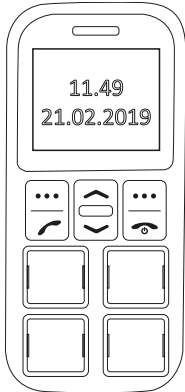

GESPREK ACCEPTEREN

19

Druk op het groene hoortje

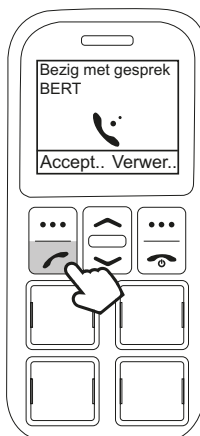

GESPREK VERBREKEN/WEIGEREN

20

Druk op het rode hoortje

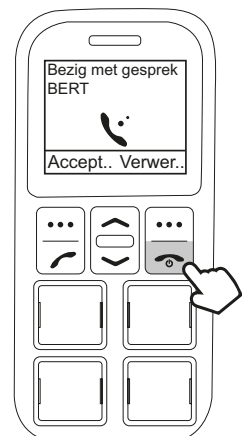

SOS CONTACTPERSONEN INSTELLEN

21

Ga naar het telefoonboek

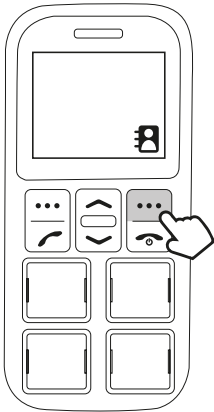

Kies contact via de pijltjestoetsen

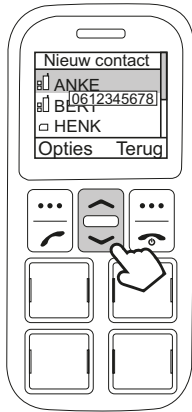

Druk op toets [Opties]

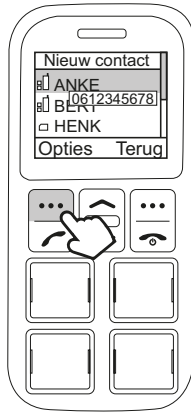

Kies via de pijltjes [Stel als SOS]



Druk op toets [OK]



Kies via de pijltjes 1, 2, 3, 4 of 5

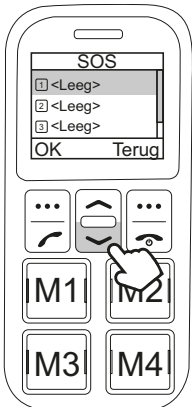

Deze 5 ingestelde personen worden op de hoogte gesteld als de alarmknop is ingedrukt.

Druk op toets [OK]

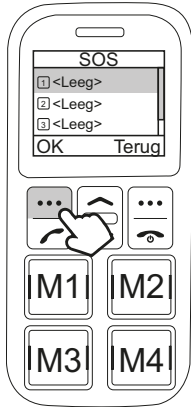

Druk op toets [Opties]

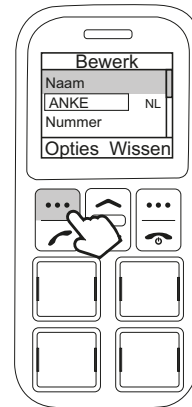

Druk op toets [Opslaan]

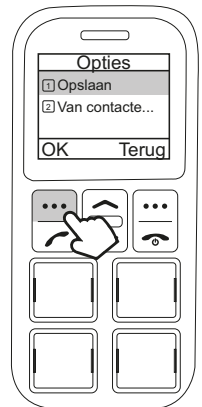

GEBRUIK VAN DE SOS-KNOP

22

Houd SOS-knop 3 seconden ingedrukt voor activeren. Druk op rode hoorntje om SOS-knop te deactiveren.

Er klinkt een alarmtoon vanaf de telefoon voor lokale alarmering.

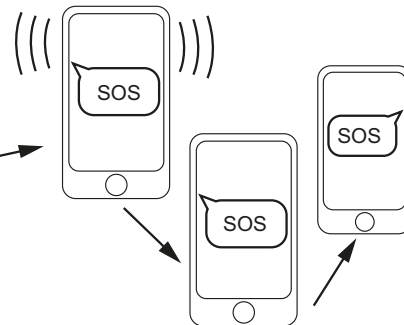
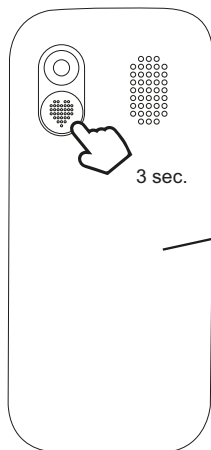

Alle ingestelde noodnummers ontvangen een tekstbericht met locatie.

De noodnummers worden één voor één gebeld.

Service		WWW.FYSIC.COM SERVICE@FYSIC.NL	FYSIC
		NL 073 6411 355 (Lokaal tarief)	
Help		BE 03 238 5666 (Lokaal tarief) (Tarif local)	
		DE 0180 503 0085 (Lokale Festnetzkosten)	
		Hesdo, Australiëlaan 1, 5232 BB, 's-Hertogenbosch, The Netherlands	