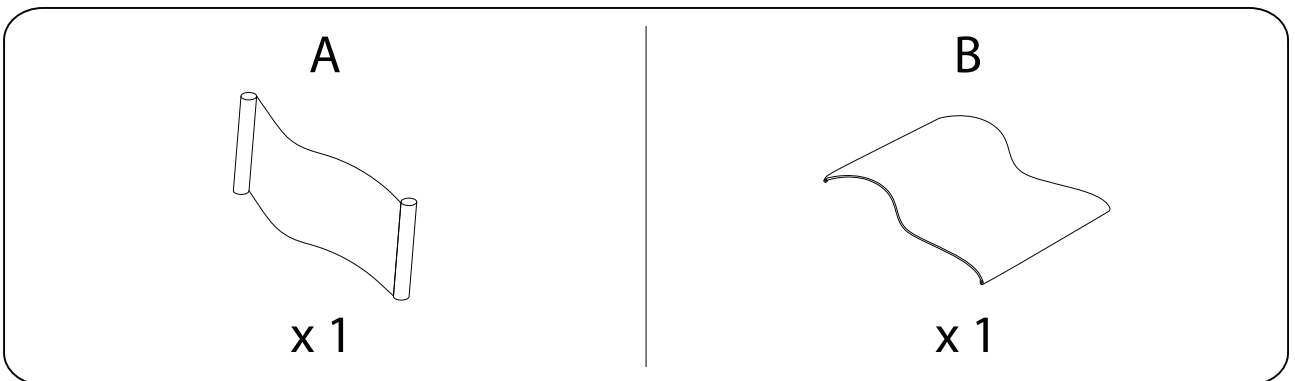
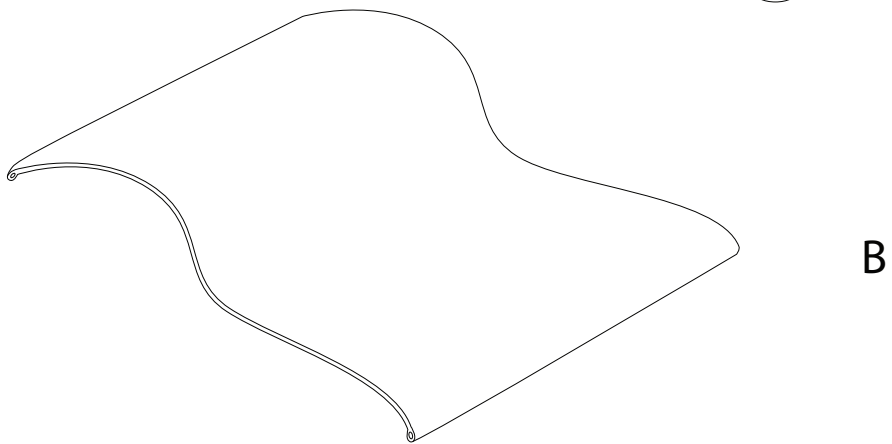
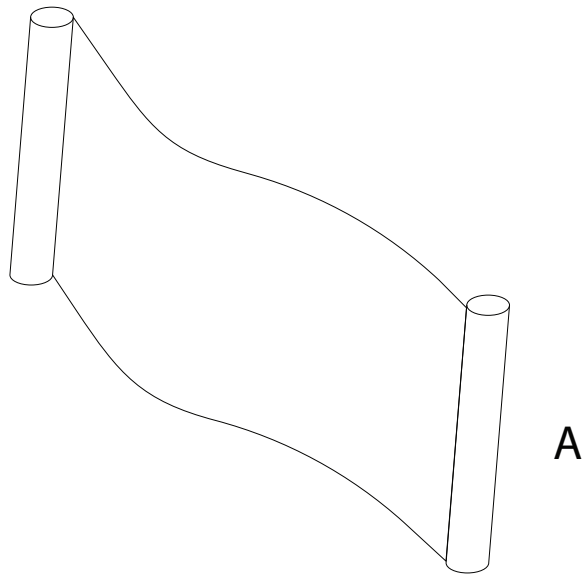

Diagram illustrating assembly instructions and safety warnings:

- Warning 1:** A crossed-out power drill icon indicates that a power drill should not be used for assembly. This warning is associated with a clock icon and the text **10'**, indicating a 10-minute time limit.
- Warning 2:** A crossed-out icon of a rectangular block being placed on a surface with a diagonal line indicates that the chair should not be placed on an uneven or soft surface. This warning is associated with a person icon and the text **1**, indicating that one person should be used for assembly.

1/4



1

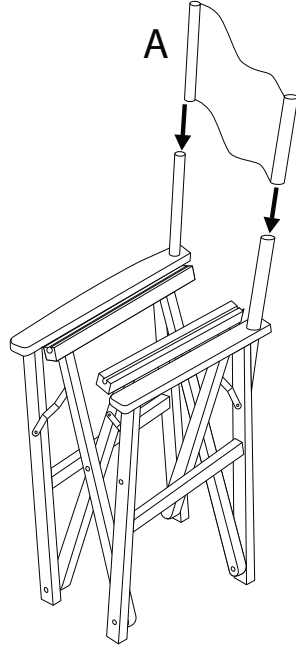
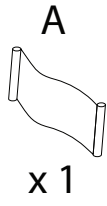

2

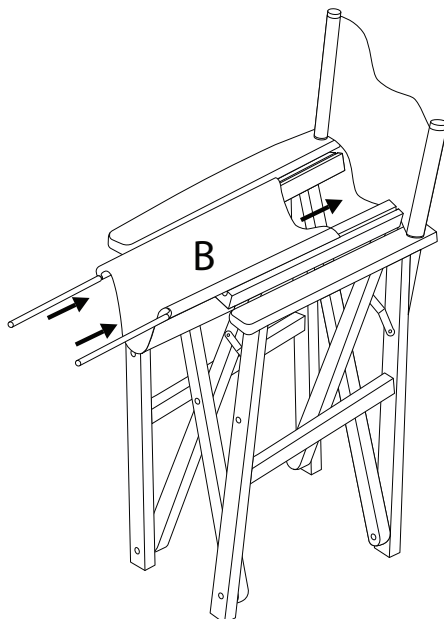
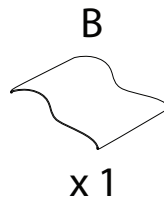

3

