

# Instant Pot®

## DUO™ PLUS

3, 5.7 and 8 Litres

Multi-Use Pressure Cookers



### User Manual

Important Safeguards  
Product Specifications  
Initial Set-up  
Product, Parts and Accessories  
Smart Programme Settings  
Cleaning Before First Use  
Overview of Pressure  
    Control Features  
Initial Test Run (Water Test)  
Cooking with the Duo Plus  
Pressure Cooking Timetable  
Grain-to-Water Ratios  
Care and Cleaning  
Troubleshooting  
Warranty  
Contact Information

# Welcome to the world of Instant cooking

---

Thank you for welcoming us into your kitchen.

Having families ourselves, we developed the Instant Pot® Duo™ Plus pressure cookers to allow busy families and professionals alike to cook healthy, delicious meals more easily and in less time.

We have partnered with chefs, authors and bloggers to compile a collection of recipes that we hope you enjoy!

Happy cooking,



Robert J. Wang  
Founder and Chief Innovation Officer



Download the Instant Pot App

- Original Recipes
- New User Tips
- Getting Started Videos



# Table of Contents

---

<b>IMPORTANT SAFEGUARDS</b> .....	5
Special Lead Set Instructions .....	7
Product Specifications.....	7
<b>Initial Setup</b> .....	8
<b>Product, Parts and Accessories</b> .....	9
<b>Control Panel</b> .....	12
<b>Smart Programme Settings</b> .....	14
Adjust and Save Pressure Cooking Temperature .....	14
Adjust and Save Pressure Cooking Time .....	14
Adjust and Save Non-Pressure Cooking Temperatures .....	14
Adjust and Save Non-Pressure Cooking Time .....	14
Cancel and Standby Mode .....	15
Turn Sound On/Off.....	15
Adjust Temperature Scale: Fahrenheit and Celsius.....	15
Set a Delay Start Timer .....	15
Automatically Keep Food Warm After Cooking .....	16
Reheat Food or Keep Warm for Long Periods.....	16
Reset Smart me to Factory Default Settings.....	16
<b>Status Messages</b> .....	17
<b>Cleaning Before First Use</b> .....	18
<b>Overview of Pressure Control Features</b> .....	19
Pressure Cooking Lid .....	19
Quick Release Button .....	20
Steam Release Valve .....	20
Anti-Block Shield .....	22

# Table of Contents

---

Sealing Ring.....	23
Float Valve.....	24
Condensation Collector.....	25
<b>Cooking with the Duo Plus .....</b>	<b>26</b>
Introduction to Pressure Cooking .....	26
<b>Depressurizing the Cooker (Venting Methods).....</b>	<b>28</b>
Natural Release (NR).....	28
Quick Release (QR).....	28
10-Minute NR.....	29
<b>Initial Test Run (Water Test) .....</b>	<b>30</b>
<b>Using Pressure Cooking Smart Programmes .....</b>	<b>31</b>
Pressure Cooking Settings.....	34
Pressure Cooking Tips.....	36
<b>Pressure Cooking Timetable.....</b>	<b>38</b>
<b>Grain-to-Water Ratios.....</b>	<b>39</b>
<b>Using Non-Pressure Cooking Smart Programmes .....</b>	<b>40</b>
Slow Cook.....	41
Sauté .....	42
Yogurt.....	43
Sous Vide .....	45
Sous Vide Cooking Guidelines .....	47
<b>Care and Cleaning .....</b>	<b>49</b>
<b>Troubleshooting.....</b>	<b>50</b>
<b>Warranty.....</b>	<b>53</b>
<b>Contact .....</b>	<b>55</b>

# IMPORTANT SAFEGUARDS

When using electrical appliances, basic safety precautions should always be followed:

1. READ THE GETTING STARTED GUIDE AND ALL INSTRUCTIONS, SAFEGUARDS AND WARNINGS BEFORE OPERATING THE APPLIANCE. FAILURE TO FOLLOW THESE SAFEGUARDS AND INSTRUCTIONS MAY RESULT IN INJURY AND/OR PROPERTY DAMAGE.
2. Do not allow children near the pressure cooker when in use. Children should not play with the appliance.
3. Do not put the pressure cooker into a heated oven or on any heated surface.
4. Do not move the pressure cooker while under pressure.
5. Do not use the pressure cooker for any purpose other than that for which it is intended.
6. This appliance cooks under pressure. Scalds may result from inappropriate use of the pressure cooker. Make sure the cooker is properly closed before applying heat. Refer to the Getting Started Guide.
7. **Never force open the pressure cooker.** Do not open before making sure that its internal pressure has completely dropped. Refer to the Getting Started Guide.
8. Never use your pressure cooker without adding water as this would seriously damage it.
9. Do not fill the cooker beyond 2/3 of its capacity. When cooking foodstuffs which expand during cooking, such as rice or dehydrated vegetables, do not fill the cooker to more than 1/2 of its capacity.
10. Use the appropriate heat source(s) according to the Getting Started Guide.
11. After cooking meat with a skin (such as ox tongue), which may swell under the effect of pressure, do not prick the meat while the skin is swollen as you may be scalded.
12. The heating element surface inside the Instant Pot base is subject to residual heat after use; do not touch.
13. Before each use, check that the valves are not obstructed. Refer to the Getting Started Guide.
14. Never use the pressure cooker in its pressurised mode for deep or shallow frying of food.



Read this manual carefully and completely, and retain for future reference. Failure to adhere to safety instructions may result in serious injury or damage.

# IMPORTANT SAFEGUARDS

15. Do not tamper with any of the safety systems beyond the maintenance instructions specified in the instructions for use.
16. Only use Instant Pot spare parts and accessories in accordance with the relevant model. In particular, use a body and a lid from the same manufacturer indicated as being compatible.
17. Do not operate any appliance with a damaged lead or plug, or after the appliance malfunctions or has been damaged in any way. If the power supply lead is damaged, users should contact Customer Care for further assistance.
18. For domestic use only. Not intended for commercial or outdoor use.
19. Be aware that certain foods such as stewed apples, cranberries, pearl barley, oatmeal or other cereals, split peas, noodles, macaroni, rhubarb or spaghetti can foam, froth and clog the steam release. These foods should not be cooked under pressure cooking settings unless as directed in Instant Pot cooker recipes.
20. Do not let children near the pressure cooker while in use.
21. Spilled food can cause serious burns. A short power-supply lead is provided to reduce the hazards resulting from grabbing, entanglement and tripping.
  - Keep the appliance and lead away from children.
  - Never drape the power lead over edges of tables or counters.
  - Never use below-counter power sockets, and never use with an extension lead.
22. Unplug your Instant Pot and let it cool before cleaning. Allow all surfaces to dry thoroughly before use.
23. The appliance is not intended to be operated by means of an external timer or a separate remote-control system.
24. Do not immerse the cooker base in water. To protect against electric shock, do not immerse the lead, power plug or cooker base in any liquid.
25. Always make sure the sealing ring is completely set in the groove on the inside of the sealing ring rack.
26. Avoid spillage on the connector.

## SAVE THESE INSTRUCTIONS



Read this manual carefully and completely, and retain for future reference. Failure to adhere to safety instructions may result in serious injury or damage.

# IMPORTANT SAFEGUARDS

## WARNING

To avoid injury, read and understand Instruction Manual before using this appliance.

## WARNING

Electrical shock hazard. Use an earthed outlet only. DO NOT remove earthing. DO NOT use an adapter. DO NOT use an extension lead. Failure to follow instructions can cause electric shock and/or death.

## WARNING

FAILURE TO FOLLOW ANY OF THE IMPORTANT SAFEGUARDS AND THE IMPORTANT INSTRUCTIONS FOR SAFE USE IS A MISUSE OF YOUR APPLIANCE THAT CAN VOID YOUR WARRANTY AND CREATE THE RISK OF SERIOUS INJURY.

## Special Lead Set Instructions

As per safety requirements, a short power supply lead is provided to reduce the hazards resulting from entanglement and tripping.

## Product Specifications



Model: Duo Plus Mini	700 W	220-240V ~ 50/60Hz	3 Litres	3.99 kg	cm: 29.2 L x 25.9 W x 27.9 H
Model: Duo Plus 60	1000 W	220-240V ~ 50/60Hz	5.7 Litres	5.60 kg	cm: 33.5 L x 31 W x 33 H
Model: Duo Plus 80	1200 W	220-240V ~ 50/60Hz	8 Litres	7.06 kg	cm: 37.6 L x 34.3 W x 36.8 H

## WARNING

Read this manual carefully and completely, and retain for future reference. Failure to adhere to safety instructions may result in serious injury or damage.

# Initial Setup

---

- Read all the [Important Safeguards](#) before using the appliance. Failure to read and follow the Important Safeguards may result in damage to the appliance, property damage or personal injury.
- Use only the Instant Pot Duo Plus lid with the Instant Pot Duo Plus pressure cooker base. Using any other pressure cooker lids may cause injury and/or damage.
- Remove all packaging material and accessories from within and around the appliance.
- Place the appliance on a stable, level surface, away from combustible material and external heat sources.
- Do not remove safety warning stickers from lid or rating label from back of cooker base.
- Follow [Care and Cleaning](#) instructions to clean the appliance before first use.

## CAUTION

Do not place the appliance on a stovetop. Heat from an external source will damage the appliance.

Do not place anything on top of the appliance, and do not cover or block the steam release valve or anti-block shield located on the appliance lid.



# Product, Parts and Accessories

## Duo Plus 3, 5.7 and 8 Litre Pressure Cookers

Before using the Instant Pot Duo Plus, verify that all parts are accounted for.

### Top of Lid

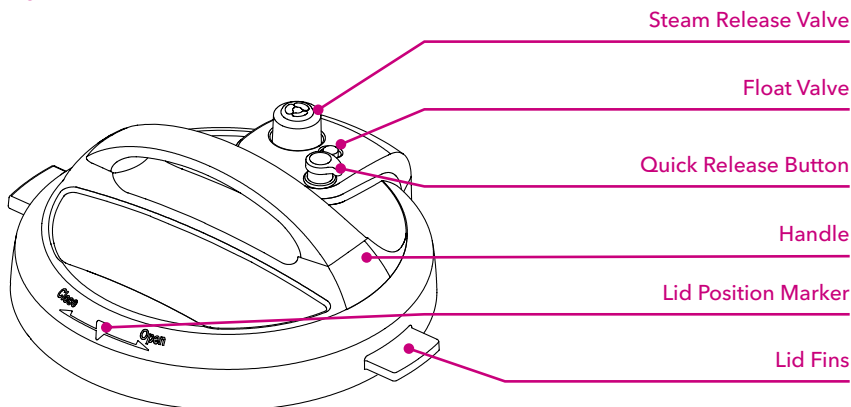

**Instant Tip:** The lid has been designed with lid fins that fit perfectly inside the handles on the left and right sides of the cooker base to help keep your countertop dry!

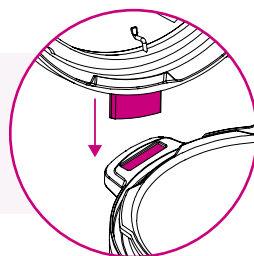

### Bottom of Lid

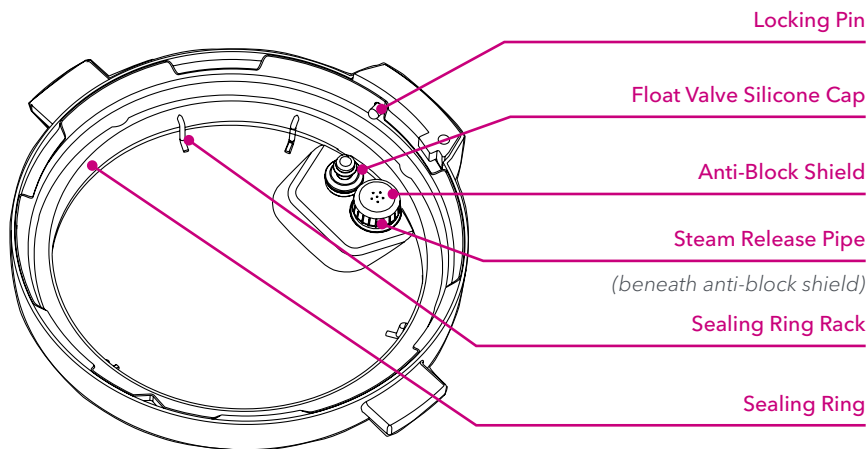

*Illustrations are for reference only and may differ from the actual product.*

# Product, Parts and Accessories

---

## Inner Pot

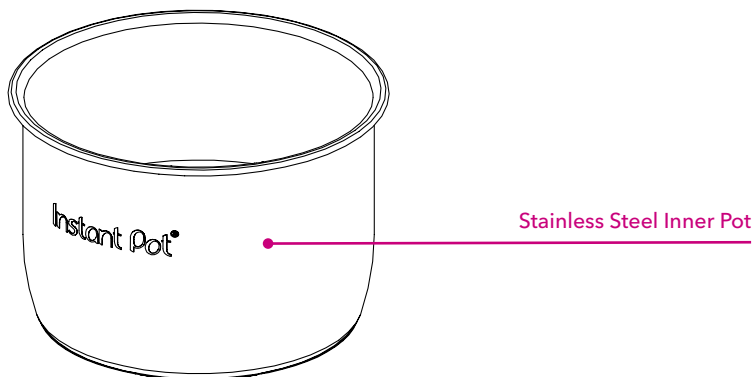

## Cooker Base

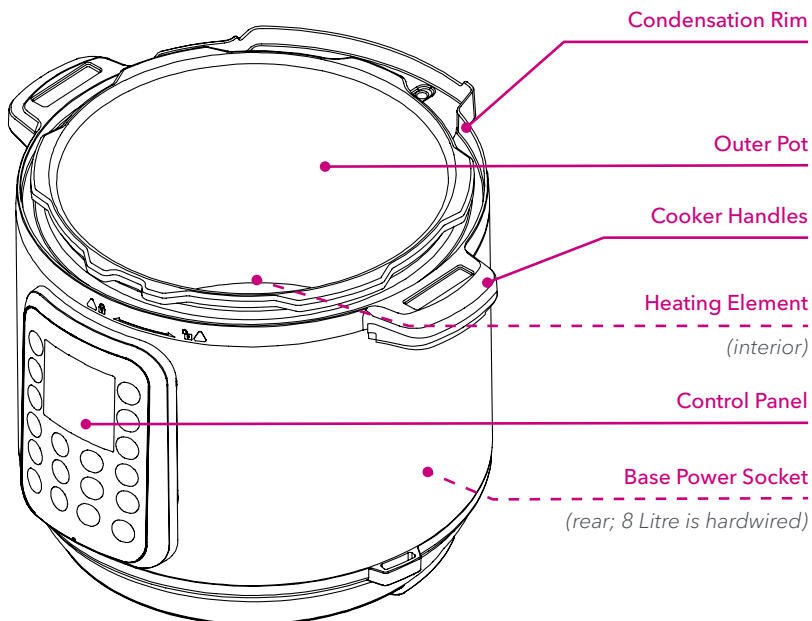

*Illustrations are for reference only and may differ from the actual product.*



# Control Panel

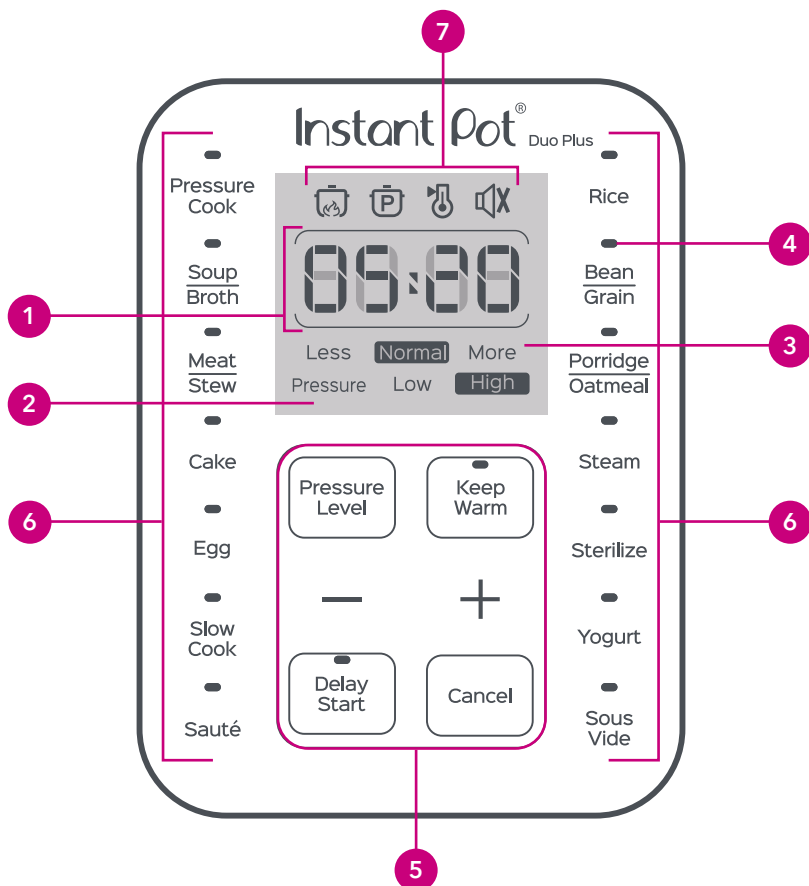

## 1 Time Display

Countdown timer indicates cooking and Delay Start time in hour format: 05:20 is 5 hours, 20 minutes.

Keep Warm timer counts up.

Display also shows **Status Icons** as described below, as well as Status Messages.

## 2 Pressure Field

Indicators light up to indicate **Low** or **High** pressure level.

## 3 Less - Normal - More

Pressure cooking: 3 preset **time** options.

Non-Pressure cooking: 3 **temperature** levels.

## 4 LED Indicators

Light up to indicate the active Smart Programme and settings selected.

# Control Panel

---

## 5 Smart Programme Settings

Pressure Level

Keep Warm

- / + buttons

Delay Start

Cancel

See [Smart Programme Settings](#) for more information.

## 6 Smart Programmes

**Pressure Cooking:**

- Pressure Cook
- Soup/Broth
- Meat/Stew
- Cake (Not available on Duo Plus Mini)
- Egg
- Rice
- Bean/Grain (Not available on Duo Plus Mini)
- Porridge/Oatmeal
- Steam
- Sterilise

**Non-Pressure Cooking:**

- Slow Cook
- Sauté
- Yogurt
- Sous Vide
- Keep Warm

## 7 Status Icons



Element is heating



Pressure cooking in progress



Keep Warm On/Off



Sound On



Sound Off

# Smart Programme Settings

---

## Adjust and Save Pressure Cooking Temperature

Select a pressure cooking Smart Programme, then press **Pressure Level** to toggle between **High** (10.2-11.6 psi) and **Low** (5.8-7.2 psi) pressure levels.

*Note: A higher pressure results in higher cooking temperature.*

When cooking begins, the pressure level you selected is saved and remembered the next time the Smart Programme is selected.

The cooking temperature may be adjusted at any time during pressure cooking by pressing **Pressure Level**, but adjustments made after cooking has begun will not be saved.

## Adjust and Save Pressure Cooking Time

Select a pressure cooking Smart Programme, then press the Smart Programme button again to cycle through the **Less**, **Normal** and **More** cooking time options.

If desired, use the **- / +** buttons to further customise the time.

When cooking begins, your customisations are saved and remembered the next time the Smart Programme is selected.

The cooking time may be adjusted at any time during pressure cooking, but adjustments made after cooking has begun will not be saved.

## Adjust and Save Non-Pressure Cooking Temperatures

Select a non-pressure cooking Smart Programme, then press the Smart Programme button again to cycle through the **Less**, **Normal** and **More** cooking temperature levels.

When cooking begins, the temperature level is saved and remembered the next time the Smart Programme is selected.

The cooking temperature may be adjusted at any time during non-pressure cooking by pressing the Smart Programme button, but adjustments made after cooking has begun will not be saved.

## Adjust and Save Non-Pressure Cooking Time

Select a non-pressure cooking Smart Programme, then use the **- / +** buttons to adjust the cooking time.

The cooking time may be adjusted at any time during non-pressure cooking, but adjustments made after cooking has begun will not be saved.

# Smart Programme Settings

---

## Cancel and Standby Mode

When the cooker is plugged in but not in operation, the display reads **OFF** to indicate Standby mode.

Press **Cancel** to stop a Smart Programme at any time. The cooker returns to Standby mode.

## Turn Sound On/Off



Sound On: When in Standby, press and hold **+** button until display indicates **S On**.



Sound Off: When in Standby, press and hold **-** button until display indicates **SOFF**.

*Note: Audible safety alerts (beeps) cannot be turned off.*

## Adjust Temperature Scale: Fahrenheit and Celsius

Press both **-** and **+** buttons simultaneously twice. Default temperature unit will be displayed.

Press the **+** button repeatedly, to toggle between °F and °C.

*Note: Temperature is only displayed within the **Sous Vide** Smart Programme.*

## Set a Delay Start Timer

Delay Start can be set to a minimum of **10** minutes or a maximum of **24** hours.

1. Select a Smart Programme and adjust the settings as you desire, then press **Delay Start**.  
*Note: Once **Delay Start** has been selected, there is no way to return to the cooking settings. To adjust Smart Programme settings, press **Cancel** and enter new selections.*
2. When the **hours field** flashes, use the **- / +** buttons to adjust the delay time. E.g., **02:00** indicates that cooking will start after 2 hours.
3. Press **Delay Start** again to toggle to the **minutes field** and follow the same process as the previous step.
4. Delay Start begins automatically after 10 seconds and the timer counts down.
5. When Delay Start ends, the Smart Programme begins, and the display indicates **On**. Delay Start is not available with the Sauté, Sous Vide or Yogurt Smart Programmes.

# Smart Programme Settings

---

## Automatically Keep Food Warm After Cooking

The Keep Warm setting turns on automatically after cooking on all Smart Programmes except Sauté, Sous Vide and Yogurt.

When automatic warming begins, the timer begins counting from **00:00** to indicate the time passed, up to **10** hours.

To turn automatic warming off, press **Keep Warm**. The LED above the button dims to indicate that it is off.

## Reheat Food or Keep Warm for Long Periods

When in Standby, select **Keep Warm**. Press **Keep Warm** again to cycle through **Less**, **Normal** and **More** warming **temperature levels**.

Use the **- / +** buttons to set a warming timer up to **99** hours and **50** minutes.

Keep Warm begins automatically after 10 seconds.

When Keep Warm completes, the display indicates **End**.

## Reset Smart me to Factory Default Settings

### Reset Individual Smart Programmes

With the cooker in Standby mode, press and hold one Smart Programme button until the cooker returns to Standby and displays **OFF**.

The Smart Programme's pressure level, cooking time and temperature are restored to the factory default setting.

### Reset All Smart Programmes

With the cooker in Standby mode, press and hold **Cancel** until the cooker beeps.

All Smart Programme pressure levels, cooking times and temperatures are restored to the factory default setting.



## Status Messages

---

OFF

Indicates that the cooker is in Standby mode.

Lid

Indicates that the pressure cooker lid is not properly secured or missing.

On

Indicates that the cooker is in **Preheat** mode.

05:20

Display timer indicates one of the following:

- When a Smart Programme is running, the display timer counts down to indicate the cooking time remaining in the Smart Programme.
- When Delay Start is running, the display timer counts down until the Smart Programme begins.
- When Keep Warm is running, the display timer counts up to indicate how long food has been warming.

Auto

Indicates that the Rice Smart Programme is running.

boil

Indicates that the Yogurt Smart Programme is in the pasteurizing cycle (i.e., the Yogurt Smart Programme is set to More).

Hot

Indicates that the Sauté Smart Programme has reached cooking temperature and food may be added to the inner pot.

End

Indicates that a Smart Programme has ended and Keep Warm is off.

Food

Indicates overheating in the cooking chamber. Refer to [Troubleshooting](#).

burn

E

Indicates that an error has occurred. Refer to [Troubleshooting](#).

## Cleaning Before First Use

Remove the inner pot from the cooker base and wash it with hot water and washing up liquid. Rinse with warm, clear water and use a soft cloth to dry the outside of the inner pot.

**Note:** The inner pot is dishwasher safe.

Wipe the heating element with a soft cloth to ensure there are no stray packaging particles present before returning the inner pot to the cooker base.

**Note:** Before cooking, always ensure the heating element is clean and dry before inserting the inner pot into the cooker base. Failure to do so may damage the cooker.

The inner pot is an integral part of product safety. Food **must** be placed in the inner pot, and never directly in the cooker base.

To avoid personal injury or damage to the appliance, replace a deformed or damaged inner pot. Use only authorised Instant Pot inner pots made for this model when cooking.

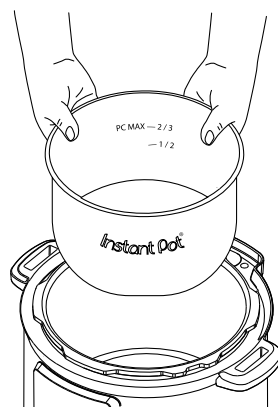

### CAUTION

To avoid risk of personal injury and/or property damage, as well as damage to the cooker, do not pour food or liquid into cooker base.

### WARNING

Do not fill the inner pot higher than the **PC MAX — 2/3** (Pressure Cooking Maximum), as indicated on the inner pot.

Exercise extreme caution when cooking and venting food such as applesauce, cranberries, pearl barley, oatmeal, split peas, noodles, etc., as these foods may foam, froth, or spatter, and may clog the steam release pipe and/or steam release valve. Do not fill the inner pot higher than the **— 1/2** line when cooking these foods.

# Overview of Pressure Control Features

---

## Pressure Cooking Lid

The stainless steel lid included is necessary for most cooking processes, and is essential for pressure cooking. Always ensure to use the Duo Plus pressure cooking lid with the Duo Plus cooker base.

When plugged in, the cooker plays a jingle when the lid is opened and closed.

### Open and Remove the Lid

Grip the lid handle and turn it anti-clockwise to align the ▼ symbol on the lid with the 🔒▲ symbol on the rim of the cooker base, then lift the lid up and off the cooker base.

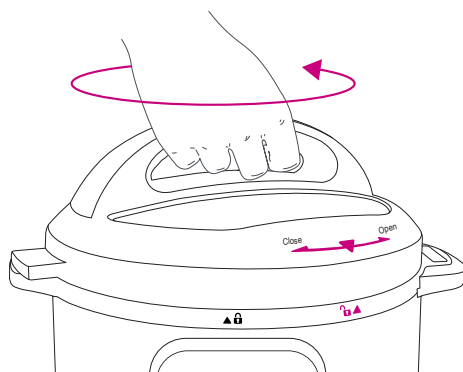

### Close the Lid

Align the ▼ symbol on the lid with the 🔒▲ symbol on the cooker base, and lower the lid onto the track. Turn the lid clockwise until the ▼ symbol on the lid aligns with the ▲🔒 symbol on the cooker base.

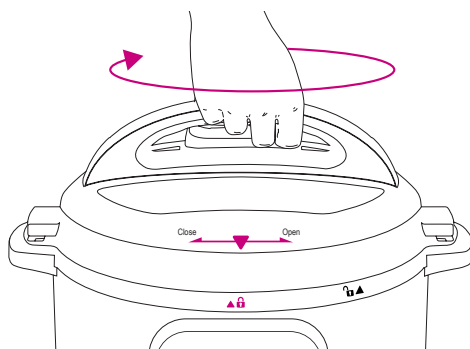

## Overview of Pressure Control Features

---

The pressure cooking lid **automatically seals** for easy pressure cooking, but **does not lock into place when closed**. The lid can be removed during Pre-heating but **locks into place once the cooker has pressurised**.

Refer to [Overview of Pressure Control Features-Float Valve](#) for information on pressurization and depressurization.

**⚠ DANGER** Do not attempt to remove the lid while the float valve is up.

**⚠ CAUTION** Always check the lid for damage and excessive wear prior to cooking.

**⚠ WARNING** Use only the Instant Pot Duo Plus lid with the Instant Pot Duo Plus pressure cooker base. Using any other pressure cooker lids may cause injury and/or damage.

### Quick Release Button

The quick release button controls the steam release valve, sealing and venting the cooker as you desire.

Refer to [Depressurizing the Cooker \(Venting Methods\)](#) for details on safe depressurization.

### Steam Release Valve

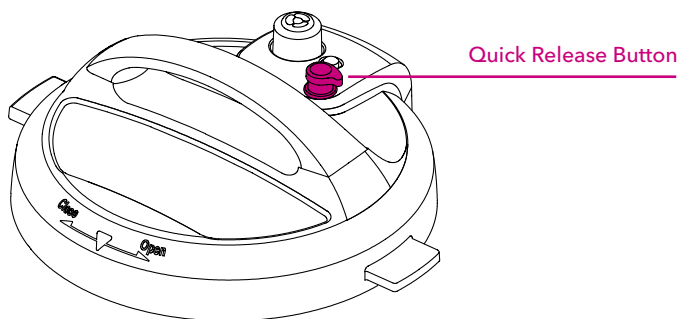

## Overview of Pressure Control Features

The steam release valve sits loosely on the steam release pipe. When the cooker releases pressure, steam ejects from the top of the steam release valve.

The steam release valve is integral to product safety and necessary for pressure cooking. It must be installed before use and cleaned regularly.

### Remove the Steam Release Valve

Pull steam release valve up and off steam release pipe.

The steam release valve must be installed before using the cooker. It should only be removed for cleaning, but should be cleaned frequently.

### Install the Steam Release Valve

Place the steam release valve on the steam release pipe and press down firmly.

The steam release valve sits loosely on the steam release pipe when installed properly but should remain in place when the lid is turned over.

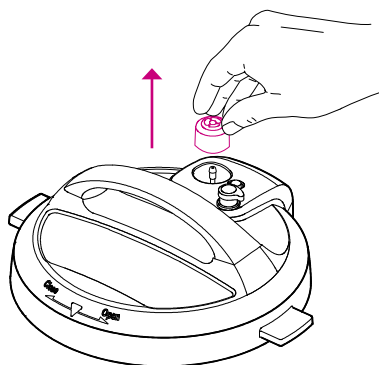
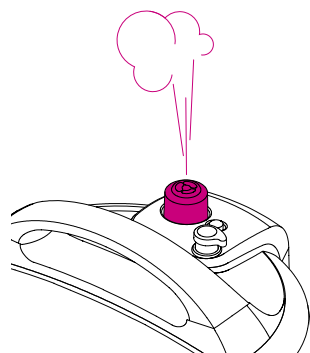

Remove

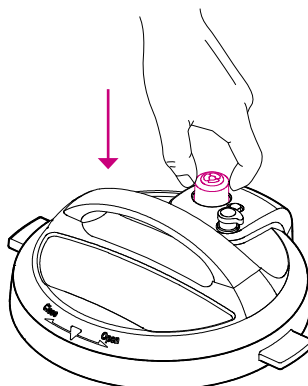

Install



**WARNING** Do not cover or block the steam release valve.

# Overview of Pressure Control Features

---

## Anti-Block Shield

The anti-block shield prevents food particles from coming up through the steam release pipe, assisting with pressure regulation.

As an integral part of product safety, the anti-block shield must be installed before use and cleaned frequently.

### Remove the Anti-Block Shield

Grip the lid like a steering wheel and use your thumbs to press firmly against the side of the anti-block shield (pressing towards the side of the lid and up) until it pops off the prongs underneath.

### Install the Anti-Block Shield

Place anti-block shield over prongs and press down until it snaps into position.

Do not attempt to operate the pressure cooker without the anti-block shield installed.

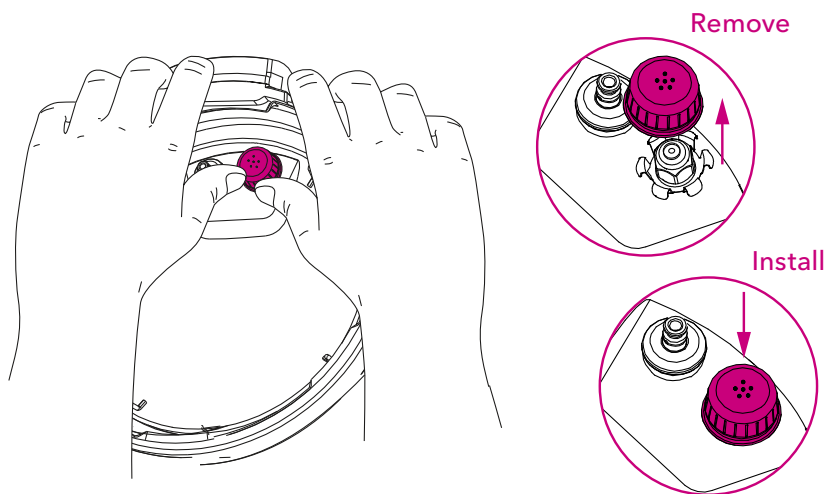

# Overview of Pressure Control Features

## Sealing Ring

When the pressure cooking lid is closed, the sealing ring installed on the underside of the lid creates an airtight seal between the lid and the cooker base.

The sealing ring must be installed before using the cooker and should be cleaned after each use.

Only 1 sealing ring should be installed in the lid when using the cooker. Use one for sweet dishes and one for savoury.

Sealing rings stretch over time with normal use. As an integral part of product safety, the sealing ring should be replaced every 12-18 months or sooner if stretching, deformation or damage is noticed.

### Remove the Sealing Ring

Grip the edge of the silicone and pull the sealing ring out from behind the circular stainless steel sealing ring rack.

With the sealing ring removed, inspect the rack to ensure it is secured, centered, and an even height all the way around the lid. Do not attempt to repair a deformed sealing ring rack.

### Install the Sealing Ring

Place the sealing ring over the sealing ring rack and press it into place. Press down firmly to alleviate puckering.

When installed properly, the sealing ring is snug behind sealing ring rack and should not fall out when the lid is turned over.

Remove

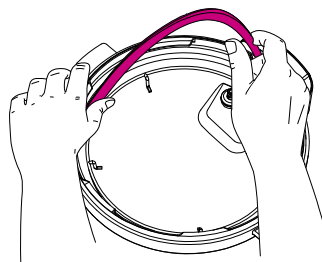

Install

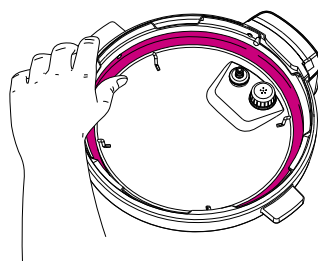

Incorrect

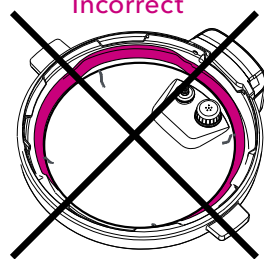

**Instant Tip:** Silicone is porous, so it may absorb strong aromas and certain flavors. Keep extra sealing rings on hand to limit the transfer of those aromas and flavors between dishes. Visit [our store](#) to color code your cooking.

#### **CAUTION**

Always check for cuts, deformation, and correct installation of the sealing ring prior to cooking. Do not use a stretched or damaged sealing ring. Only use authorised Instant Pot sealing rings. Failure to follow these instructions may cause food to discharge, which may lead to personal injury or property damage.

# Overview of Pressure Control Features

---

## Float Valve

The float valve provides a visual indication of pressure within the cooker and appears in 2 positions.

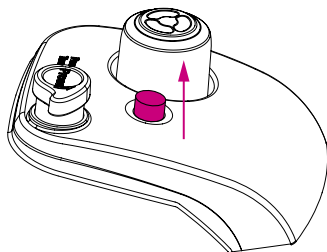

### Pressurised

The float valve has visibly popped up above the surface of the lid.

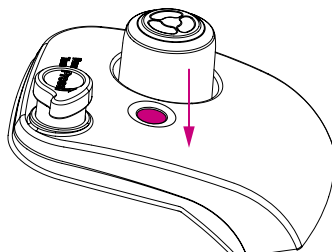

### Depressurised

The float valve has descended and the top is flush with the lid.

The float valve and silicone cap work together to seal in pressurised steam. These parts must be installed before use and should be cleaned after each use.

## Remove the Float Valve from the Lid

Place one finger on the flat top of float valve, then turn the lid over. Detach the silicone cap from the bottom side of the float valve.

Remove the float valve from the top of the lid. Do not discard the float valve or silicone cap.



### Top

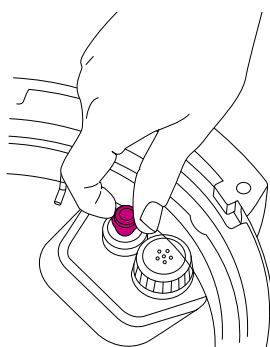

### Bottom



# Overview of Pressure Control Features

---

## Install the Float Valve

Drop the narrow end of the float valve into the float valve hole on the top of the lid. Place one finger on the flat top of the float valve, then turn the lid over. Firmly attach the silicone cap to the bottom of the float valve.

Do not attempt to operate the pressure cooker without the float valve and/or silicone cap properly installed in the pressure cooking lid.

### **⚠ DANGER**

While the float valve is up, contents of cooker are under extreme pressure. **Do not attempt to remove the lid.** All pressure **must** be released, and float valve must be **down**. Refer to [Depressurising the Cooker \(Venting Methods\)](#) for information on releasing pressure. Failure to follow these instructions may result in property damage and/or personal injury.

## Condensation Collector

The condensation collector sits at the back of the cooker base and accumulates overflow moisture from the condensation rim. It should be installed before cooking, then emptied and rinsed out after each use.

### Remove the Condensation Collector

Pull the condensation collector **away** from the cooker base; do not pull down. Note the tabs on the cooker base and the grooves on the condensation collector.

### Install the Condensation Collector

Align the grooves on the condensation collector over the tabs on the back of the cooker base and slide the condensation collector into place.

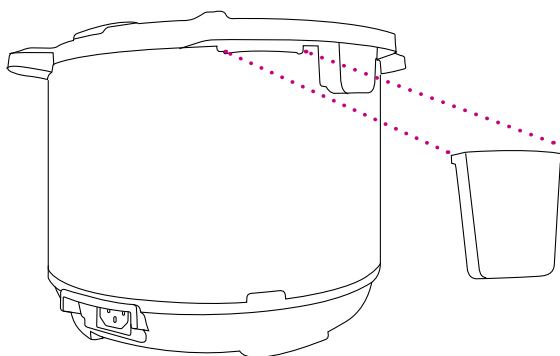

# Cooking with the Duo Plus

---

## Introduction to Pressure Cooking

Pressure cooking uses steam pressure to raise the boiling point of water above. This energy-efficient cooking method is the fastest way to thoroughly cook a variety of your favourite meals.

Pressure cookers go through 3 stages when pressure cooking:

### 1. Pre-Heating and Pressurisation

The cooker waits 10 seconds to ensure you have finished inputting your selections, then displays **On** to indicate it has begun pre-heating. While the cooker pre-heats, it vaporises liquid in the inner pot to create steam. Once enough steam has built up inside the inner pot, the float valve pops up and locks the lid of the cooker in place for safe pressure cooking.

When the float valve pops up, the silicone cap attached to the bottom of the float valve (on the underside of the lid) seals the steam inside the cooking chamber (the inner pot) and allows the pressure to rise even higher. A higher pressure means a higher cooking temperature.

While it is normal to see some steam escaping through the float valve during Pre-Heating, if you see steam escaping from around the sides of the lid, press **Cancel** and refer to [Troubleshooting](#).

***Note:** The time it takes your cooker to pressurise is determined by a variety of factors, including food and liquid volume.*

### 2. Cooking

After the float valve pops up, the cooker needs a few minutes to finish building pressure. When the required pressure level is reached, cooking begins. The display switches from **On** to the cooking countdown timer, displayed in **HH:MM** (hours : minutes) format.

Smart Programme settings (e.g., cooking time, temperature and/or pressure level, and whether Keep Warm will come on automatically or not) can be adjusted at any time during cooking. Refer to [Smart Programme Settings](#) for details.

# Cooking with the Duo Plus

---

## 3. Depressurisation

After pressure cooking completes, follow your recipe instructions for depressurizing the cooker.

If automatic **Keep Warm** is on after cooking is complete, the timer counts up from **00:00** to indicate the elapsed time up to **10:00** hours. If not, the cooker returns to Standby and displays **End**.

*Note: The cooker cools and depressurises faster if automatic Keep Warm is off.*

See [Depressurizing the Cooker \(Venting Methods\)](#) for information on releasing pressure after cooking.

### **⚠ DANGER**

While the float valve is up, contents of cooker are under extreme pressure. **Do not attempt to remove the lid while the float valve is still up.** All pressure **must** be released, and float valve must be **down** before attempting to remove the lid. **Never attempt to force the lid open.** Failure to follow the instructions may result in property damage and/or personal injury.

# Depressurizing the Cooker (Venting Methods)

Always follow recipe instructions for depressurizing the cooker.

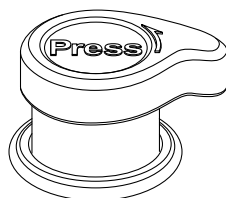

Seal Position



Vent Position

## Natural Release (NR)

Leave the quick release button in the popped-up **Seal** position. As the temperature within the cooker drops, the cooker depressurises naturally over time.

Depressurization time varies based upon the volume and type of food and liquid. When the cooker has completely depressurised, the float valve drops into the lid.

### NOTICE

Use NR to depressurise the cooker after cooking high-starch foods (e.g., soups, stews, chilis, pasta, oatmeal and congee) or after cooking foods that expand when cooked (e.g., beans and grains).

## Quick Release (QR)

Press the quick release button down until it clicks and locks into the **Vent** position.

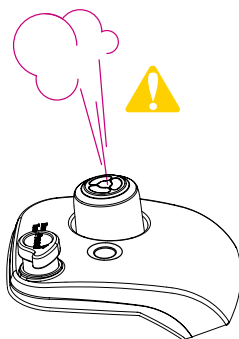
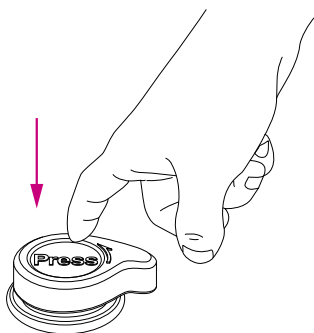

When depressed, a stream of steam releases through the top of the steam release valve.

### CAUTION

Steam ejected from the steam release valve is hot. Do not place hands, face, or any exposed skin over the steam release valve when releasing pressure.

*Note: Steam may range in opacity but is always loud!*

When the cooker has completely depressurised, the float valve drops into the lid.

## Depressurizing the Cooker (Venting Methods)

If continuous spatter occurs while venting, set the cooker back to **Seal** by flicking the quick release button. The button pops back up to indicate that it is sealed and stops the depressurization process. Wait a few minutes before trying to QR again. If spatter continues, use NR to safely release remaining pressure.

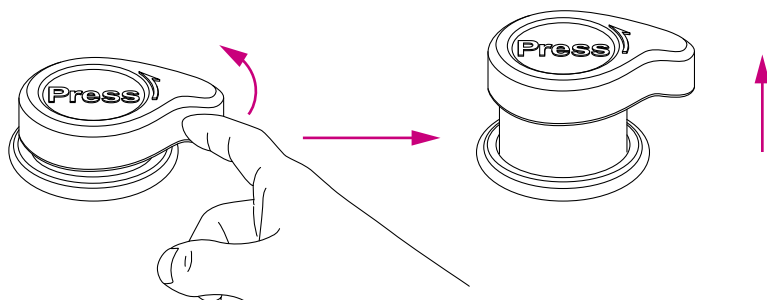

### NOTICE

Do not use QR when cooking high-starch foods (e.g., stews, chilis, pasta and congee) or when cooking foods that expand when cooked (e.g., beans and grains).

### 10-Minute NR

Leave the quick release button in the popped-up **Seal** position for **00:10** minutes after cooking has completed, then press the quick release button down until it clicks and locks into the **Vent** position. When depressed, a stream of steam releases through the top of the steam release valve.

If continuous spatter occurs while venting, set the cooker back to **Seal** by flicking the quick release button. Wait an additional 5 minutes before trying to QR again. If spatter continues, use NR to safely release remaining pressure.

### ⚠ DANGER

While the float valve is up, contents of cooker are under extreme pressure. **Do not attempt to remove the lid while the float valve is still up.** All pressure **must** be released, and float valve must be **down** before attempting to remove the lid. **Never attempt to force the lid open.** Failure to follow the instructions may result in property damage and/or personal injury.

### ⚠ WARNING

Do not lean over or touch the steam release valve.

Do not place unprotected skin over the steam release valve.

Do not cover or obstruct the steam release valve.

## Initial Test Run (Water Test)

---

Follow these steps to familiarise yourself with your Instant Pot Duo Plus.

Total test time: Approximately 20 minutes.

1. Remove the inner pot from the cooker base.
2. Add 750 mL of water to the inner pot.
3. Insert the inner pot into the cooker base.
4. Secure the power lead to the base power socket at the back of the cooker base. Ensure the connection is tight. Connect the power lead to a 220-240 V power source. The display indicates **OFF**.
5. Place and close the lid as described in [Pressure Control Features–Pressure Locking Lid](#). The lid automatically seals for pressure cooking.
6. Press **Pressure Cook** to select the Pressure Cook Smart Programme.
7. Use the **- / +** buttons to adjust the cooking time to **00:05** minutes.

*Note: Cooking temperature adjustments are saved to the Smart Programme when cooking begins.*

8. Press **Keep Warm** to deactivate the automatic Keep Warm setting. After 10 seconds, the display reads **On** to indicate that the **Pre-heating** cycle has begun.
9. The float valve rises when the cooker has pressurised. After a few minutes the cooker reaches the target pressure level and **Cooking** begins. The display changes from **On** to the cook time countdown.
10. When the Smart Programme is complete, the display indicates **End**.
11. Press the quick release button down until it clicks into the **Vent** position. Pressurised steam releases through the top of the steam release valve.
12. The float valve drops when the pressure has been fully released.
13. Open and remove the lid as described in [Pressure Control Features–Pressure Cooking Lid](#).
14. Carefully remove the inner pot from the cooker base, discard the water and thoroughly dry the inner pot.

You're ready to start cooking!



The inner pot will be hot after cooking. Always use appropriate heat protection when handling a hot inner pot.

## Using Pressure Cooking Smart Programmes

Whether you are a novice cook or a culinary expert, the Duo Plus provides Smart Programmes to get you cooking with the touch of a button.

The steps below follow the safest procedure for using the cooker and can be applied to the following Smart Programmes: Pressure Cook, Soup/Broth, Meat/Stew, Cake\*, Egg, Rice, Bean/Grain\*, Porridge/Oatmeal, Steam and Sterilise.

*\*Not available on Duo Plus Mini. Use Pressure Cook instead.*

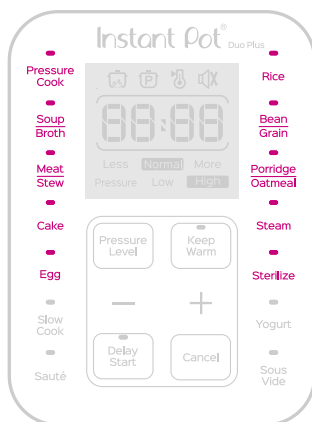

Always inspect your Instant Pot pressure cooking lid, inner pot and cooker base carefully to ensure they are clean and in good working condition before use.

Instant Pot® Size	Minimum Liquid for Pressure Cooking*
2.8 Litres	250 mL
5.7 Litres	375 mL
7.6 Litres	500 mL

*\*Unless otherwise specified in recipe.*

Pressure cooking liquids should be water-based, such as broth, stock, soup or juice. If using tinned, condensed or cream-based soup, add water as directed above.

### **CAUTION**

To avoid scorching or scalding injuries, be cautious when cooking with more than 60 mL of oil, oil-based sauces, condensed cream-based soups and thick sauces. Add suitable liquid to thin sauces. Avoid recipes that call for more than 60 mL of oil or fat content.

# Using Pressure Cooking Smart Programmes

---

1. Open and remove the lid as described in [Pressure Control Features–Pressure Cooking Lid](#).

2. Remove the inner pot from the cooker base.

3. Add food and liquid ingredients to the inner pot.

*Note: Cold or frozen food items take longer to generate steam and slow down pressurization. For the fastest results, thaw frozen ingredients before cooking.*

4. Insert the inner pot into the cooker base.

5. Secure the power lead to the base power socket at the back of the cooker base. Ensure the connection is tight.

**All:** Connect the power lead to a 220-240 V power source.

The cooker goes to Standby mode and the display indicates **OFF**.

6. Place and close the lid as described in [Pressure Control Features–Pressure Locking Lid](#).

*Note: The quick release button will automatically pop up to the Seal position for pressure cooking.*

7. Select your desired pressure cooking Smart Programme.

8. Press the same Smart Programme button again to cycle through **Less**, **Normal** and **More** time options.

9. For custom cooking, use the **- / +** buttons to adjust the cooking time.

10. Press **Pressure Level** to toggle between **Low** and **High** pressure.

*Note: When pressure cooking, the pressure level controls the temperature. A higher pressure results in a higher cooking temperature.*

*Note: Cooking time and pressure level adjustments are saved to the Smart Programme when cooking begins*

11. Press **Keep Warm** to toggle the automatic Keep Warm setting off or on, as you desire.

12. After 10 seconds, the display reads **On** and indicates that **Pre-heating** has begun.

13. When cooking is complete, follow recipe directions to select the appropriate venting method. Refer to [Depressurizing the Cooker \(Venting Methods\)](#).

**Instant Tip:** Use the steam rack to lift foods out of the cooking liquid. This ensures even heat distribution, prevents nutrients from leeching into the cooking liquid, and stops food items from scorching on the bottom of the inner pot.



# Using Pressure Cooking Smart Programmes

---

## **⚠ DANGER**

While the float valve is up, contents of cooker are under extreme pressure. **Do not attempt to remove the lid while the float valve is still up.** All pressure **must** be released, and float valve must be **down** before attempting to remove the lid. **Never attempt to force the lid open.** Failure to follow the instructions may result in property damage and/or personal injury.

## **⚠ WARNING**

Do not fill inner pot higher than the **PC MAX — 2/3** line as indicated on the inner pot.

When cooking foods that expand (e.g., rice, beans, pasta) do not fill the inner pot higher than the **— 1/2** line as indicated on the inner pot.

Always cook with the inner pot in place. Do not pour food or liquid into the cooker base.

To avoid risk of personal injury and/or property damage, place food and liquid ingredients in the inner pot, then insert the inner pot into the cooker base.

# Using Pressure Cooking Smart Programmes

## Pressure Cooking Settings

Smart Programme	Settings			
Meat/Stew	Pressure	<b>Low</b> (35-55 kPa / 5.8-7.2 psi) <b>High</b> (65-85 kPa / 10.2-11.6 psi)		
	Time Setting	Less	Normal	More
	Default Cooking Time (adjustable)	00:20	00:35	00:45
	Cooking Time Range	00:01-04:00		
Bean/Grain*	Pressure	<b>Low</b> (35-55 kPa / 5.8-7.2 psi) <b>High</b> (65-85 kPa / 10.2-11.6 psi)		
	Time Setting	Less	Normal	More
	Default Cooking Time (adjustable)	00:25	00:30	00:40
	Cooking Time Range	00:01-04:00		
Soup/Broth	Pressure	<b>Low</b> (35-55 kPa / 5.8-7.2 psi) <b>High</b> (65-85 kPa / 10.2-11.6 psi)		
	Time Setting	Less	Normal	More
	Default Cooking Time (adjustable)	00:20	00:30	04:00
	Cooking Time Range	00:01-04:00		
Rice	Pressure	<b>Low</b> (35-55 kPa / 5.8-7.2 psi) <b>High</b> (65-85 kPa / 10.2-11.6 psi)		
	Time Setting	Less	Normal	More
	Default Cooking Time (adjustable)	00:08	00:12	00:15
	Cooking Time Range	Time is not adjustable. Display indicates <b>Auto</b> while Pre-heating.		
Porridge/Oatmeal	Pressure	<b>Low</b> (35-55 kPa / 5.8-7.2 psi) <b>High</b> (65-85 kPa / 10.2-11.6 psi)		
	Time Setting	Less	Normal	More
	Default Cooking Time (adjustable)	00:05	00:20	00:30
	Cooking Time Range	00:01-04:00		
Steam	Pressure	<b>Low</b> (35-55 kPa / 5.8-7.2 psi) <b>High</b> (65-85 kPa / 10.2-11.6 psi)		
	Time Setting	Less	Normal	More
	Default Cooking Time (adjustable)	00:03	00:10	00:15
	Cooking Time Range	00:01-04:00		

\*Not available on Duo Plus Mini. Use Pressure Cook instead.

## Using Pressure Cooking Smart Programmes

Smart Programme	Settings			
Sterilise	Pressure	None**	Low (35-55 kPa / 5.8-7.2 psi) High (65-85 kPa / 10.2-11.6 psi)	
	Time Setting	Less	Normal	More
	Default Cooking Time (adjustable)	00:30	00:30	00:30
	Cooking Time Range	00:01-04:00		
Cake*	Pressure	Low (35-55 kPa / 5.8-7.2 psi) High (65-85 kPa / 10.2-11.6 psi)		
	Time Setting	Less	Normal	More
	Default Cooking Time (adjustable)	00:25	00:40	00:50
	Cooking Time Range	00:01-04:00		
Egg	Pressure	Low (35-55 kPa / 5.8-7.2 psi) High (65-85 kPa / 10.2-11.6 psi)		
	Time Setting	Less	Normal	More
	Default Cooking Time (adjustable)	00:04	00:05	00:06
	Cooking Time Range	00:01-04:00		
Pressure Cook	Pressure	Low (35-55 kPa / 5.8-7.2 psi) High (65-85 kPa / 10.2-11.6 psi)		
	Time Setting	Less	Normal	More
	Default Cooking Time (adjustable)	00:20	00:35	00:45
	Cooking Time Range	00:01-04:00		

\*Not available on Duo Plus Mini. Use Pressure Cook instead.

\*\*The Less setting on the Sterilise Smart Programme does not apply pressure.

# Using Pressure Cooking Smart Programmes

## Pressure Cooking Tips

Smart Programme	Setting	Suggested Use	Notes
Meat/Stew	Less	Soft texture	Choose setting based on meat texture desired, or adjust cook time manually.
	Normal	Very soft texture	
	More	Fall-off-the-bone	Allow meat to "rest" for 5-30 minutes, depending on size. It will retain cooking juices for tender, succulent meat.
Bean/Grain*	Less	Firmer texture	Choose setting based on bean/grain texture desired, or adjust cook time manually.
	Normal	Soft texture	When cooking beans or legumes, always use NR to release pressure.
	More	Very soft texture	Ensure dry beans are completely submerged in water.
Soup/Broth	Less	Soup without meat	Liquid remains clear due to lack of boiling motion.
	Normal	Soup with meat	
	More	Rich bone broth	Always use NR to release pressure when cooking soup with a high starch content.
Rice	Less	Tender but firm to bite	Automated cooking Smart Programme. Displays <b>Auto</b> before cook time countdown. After cooking, wait 10 minutes, then use QR to release pressure, or allow to depressurise with NR.
	Normal	Normal texture white rice	
	More	Softer texture white rice	
Porridge/Oatmeal	Less	Oatmeal, coarse or rolled	Adjust time as directed in recipe. Always use NR to release pressure when cooking foods that expand.
	Normal	White rice, porridge/congee	
	More	Rice porridge/congee with a mixture of various grains	
Steam	Less	Vegetables	Use steam rack provided to elevate food from cooking liquid.
	Normal	Fish and Seafood	
	More	Meat	Use QR to prevent food from overcooking.

\*Not available on Duo Plus Mini. Use Pressure Cook instead.

## Using Pressure Cooking Smart Programmes

Smart Programme	Setting	Suggested Use	Notes
Sterilise	Less	No pressure steam sterilisation	Sterilise utensils, tempered glass and heat-resistant plastics.
	Normal	Sterilisation and water-bath canning	Sterilise utensils, tempered glass and some heat-resistant plastics. Low pressure hot water bath canning of acidic fruits and vegetables.
	More	Sterilisation and water-bath canning	Sterilise utensils, tempered glass and some heat-resistant plastics. High pressure hot water bath canning of acidic fruits and vegetables.
Cake*	Less	Lighter moist cakes	Adjust cook time as directed in recipe.
	Normal	Denser moist cakes	Cake mixture should be poured into a springform tin and covered with foil or an oven-safe lid.
	More	Cheesecakes	Leave 1" of space around the tin to ensure heat circulates properly.
Egg	Less	Soft-boiled eggs	Pre-set times are intended for extra large eggs.
	Normal	Medium-boiled eggs	Adjust cooking time to account for different sized eggs.
	More	Hard-boiled eggs	Plunge eggs into ice bath to prevent overcooking.
Pressure Cook	Less	Manual programming	Press <b>Pressure Level</b> to toggle between <b>High</b> and <b>Low</b> pressure. Use <b>- / +</b> buttons to adjust cook time. Adjust according to recipe or desired results.
	Normal		
	More		

\*Not available on Duo Plus Mini. Use Pressure Cook instead.

### CAUTION

Always use a meat thermometer to ensure the internal temperature reaches a safe minimum temperature. Refer to the USDA's [Safe Minimum Internal Temperature Chart](#) for more information.

# Pressure Cooking Timetable

The following are recommendations only. Always follow a trusted recipe.

Food		Time
Vegetables	Asparagus, Beans (Yellow and Green), Broccoli	1-2 minutes
	Brussels Sprouts, Cabbage (Whole or Wedges), Cauliflower (Florets)	2-3 minutes
	Butternut Squash	4-6 minutes
	Carrots (Whole or Chunks)	6-8 minutes
	Corn (on the Cob)	3-5 minutes
	Potatoes (Large, Whole)	12-15 minutes
	Potatoes (Small, Whole)	8-10 minutes
	Potatoes (Cubed)	3-4 minutes
	Sweet Potatoes (Whole)	12-15 minutes
Sweet Potatoes (Cubed)	2-4 minutes	
Meat & Eggs	Beef (Stew)	20 minutes (per 450 g)
	Beef (Large Pieces), Beef (Ribs)	20-25 minutes (per 450 g)
	Chicken (Breasts)	6-8 minutes (per 450 g)
	Chicken (Whole)	8 minutes (per 450 g)
	Chicken (Bone Stock)	40-50 minutes
	Lamb (Leg), Pork (Shoulder Roast)	15 minutes (per 450 g)
	Pork (Loin Ribs)	15-20 minutes (per 450 g)
	Eggs	Hard: 5 mins
Beans & Lentils (Dry & Soaked)	Black Beans	D: 20-25 mins / S: 6-8 mins
	Black-Eyed Peas	D: 14-18 mins / S: 4-5 mins
	Chickpeas	D: 35-40 mins / S: 10-15 mins
	Kidney Beans (Red), Haricot Beans	D: 20-25 mins / S: 7-8 mins
	Kidney Beans (White), Pinto Beans	D: 25-30 mins / S: 6-9 mins
	Lentils (Green)	D: 8-10 mins / S: N/A
	Lentils (Yellow)	D: 1-2 mins / S: N/A
	Butter Beans	D: 12-14 mins / S: 6-10 mins
Soybeans	D: 35-45 mins / S: 18-20 mins	
Seafood	Fish (Whole)	4-5 minutes
	Fish (Fillet), Lobster	2-3 minutes
	Mussels	1-2 minutes
	Shrimp (Or Prawn)	1-3 minutes
	Seafood Stock	7-8 minutes

## Grain-to-Water Ratios

---

Rice and Grain	Grain : Water Ratio
White or Brown Rice	1 : 1
Quinoa	1 : 3/4
Oatmeal	1 : 3
Risotto	1 : 2 add additional wine to taste
Porridge	1 : 10

Click [here](#) for a complete list of cooking timetables.

## Using Non-Pressure Cooking Smart Programmes

The Duo Plus is much more than a pressure cooker. These non-pressure cooking Smart Programmes get you cooking quickly and easily.

Always ensure the lid is set to **Vent** when using non-pressure cooking programmes. Press the quick release button down until it clicks and locks in place.

The following sections provide the safest steps for using the Slow Cook, Sauté, Yogurt and Sous Vide Smart Programmes.

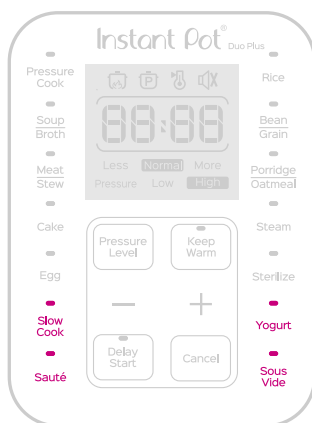

Always inspect your Instant Pot pressure cooking lid, inner pot and cooker base carefully to ensure they are clean and in good working condition before use.

### ⚠ WARNING

Do not fill inner pot higher than the **PC MAX — 2/3** line as indicated on the inner pot.

When cooking foods that expand (e.g., rice, beans, pasta) do not fill the inner pot higher than the **— 1/2** line as indicated on the inner pot.

Always cook with the inner pot in place. Do not pour food or liquid into the cooker base.

To avoid risk of personal injury and/or property damage, place food and liquid ingredients in the inner pot, then insert the inner pot into the cooker base.



# Using Non-Pressure Cooking Smart Programmes

## Slow Cook

Slow Cook is a non-pressure cooking programme that is compatible for use with any standard slow cooker recipe.

1. Remove the inner pot from the cooker base.
2. Add food and liquid ingredients to the inner pot.
3. Insert the inner pot into the cooker base.
4. Secure the power lead to the base power socket at the back of the cooker base. Ensure the connection is tight.  
Connect the power lead to a 220-240 V power source.  
The cooker goes to Standby mode and the display indicates **OFF**.
5. Place and close the lid as described in [Pressure Control Features–Pressure Locking Lid](#), or use a [glass lid](#) with a venting hole.
6. Press the quick release button down until it clicks and locks into the **Vent** position.
7. Press **Slow Cook** to select the Slow Cook Smart Programme.
8. Press **Slow Cook** again to cycle through the **Less**, **Normal** and **More temperature** options.
9. Use the **- / +** buttons to adjust the cooking time.

*Note: Cooking time and temperature level adjustments are saved to the Smart Programme when cooking begins.*

10. Press **Keep Warm** to toggle the automatic Keep Warm setting off and on.
11. After 10 seconds, cooking begins and the display timer counts down.
12. When cooking completes, the display indicates **End** if Keep Warm is turned off. If not, the timer begins counting from **00:00** up to **10** hours.

*Note: The float valve should not rise during Slow Cook. The lid is removable throughout the cooking process for easy access. If the float valve rises, ensure the quick release button is set to the **Vent** position. Refer to [Depressurising Your Cooker \(Venting Methods\)](#).*

Setting	Suggested Use	Notes
Less	Low setting on standard slow cookers	Follow recipe directions for slow cooking. <b>Less</b> is commonly used for low and slow, all-day cooking, and should be set for a minimum of <b>10</b> hours for best results.
Normal	Medium setting on standard slow cookers	
More	High setting on standard slow cookers	

# Using Non-Pressure Cooking Smart Programmes

## Sauté

Sauté is a non-pressure cooking programme that can be used in place of a frying pan or flat-top grill.

1. Insert the inner pot into the cooker base. **Do not use a lid.**
2. Secure the power lead to the base power socket at the back of the cooker base. Ensure the connection is tight.  
Connect the power lead to a 220-240 V power source.  
The cooker goes to Standby mode and the display indicates **OFF**.
3. Press **Sauté** to select the Sauté Smart Programme.
4. Press **Sauté** again to cycle through the **Less**, **Normal** and **More** temperature options.

***Note:** Cooking temperature adjustments are saved to the Smart Programme when cooking begins.*

5. After 10 seconds, the cooker displays **On** to indicate that it has begun heating.
6. When display switches from **On** to **Hot**, add recipe ingredients.

***Note:** If recipe ingredients are added before the Hot message appears, it may not appear at all. This is normal.*

7. When cooking completes, the display indicates **End**.

***Note:** Automatic Keep Warm cannot be turned on for the Sauté Smart Programme.*

Setting	Suggested Use	Notes
Less	Simmering, thickening and reducing liquids	The display switching from <b>Hot</b> to <b>On</b> indicates the cooker is maintaining the cooking temperature. As a safety precaution, 30 minutes is the maximum cooking time and cannot be adjusted.
Normal	Pan searing or sautéing	
More	Stir-frying or browning meat	

## Deglazing the Inner Pot (Pressure Cooking After Sauté)

Sautéing meat and vegetables before pressure cooking is the perfect way to boost flavors, as sugars caramelize from the high heat of the Sauté Smart Programme.

To pressure cook after using Sauté, **deglaze** the inner pot to ensure food items do not scorch.

**To deglaze:** remove food items from the inner pot and add a thin liquid (e.g., water, broth, wine) to the hot surface. Use a wooden or silicone scraper to loosen anything that may be stuck to the bottom of the inner pot.

### **WARNING**

The Sauté Smart Programme reaches high temperatures. If unmonitored, food may burn on this setting. Do not use the lid and do not leave your cooker unattended while using Sauté.

# Using Non-Pressure Cooking Smart Programmes

## Yogurt

Yogurt is a non-pressure cooking Smart Programme made for easy fermented dairy and non-dairy recipes.

Instant Pot® Size	Minimum Milk Volume	Maximum Milk Volume
2.8 Litres	500 mL	2.3 L
5.7 Litres	1000 mL	4.5 L
7.6 Litres	1500 mL	6.8 L

### Pasteurise Milk

1. Remove the inner pot from the cooker base.
2. Add unpasteurised milk to the inner pot then insert the inner pot into the cooker base.
3. Secure the power lead to the base power socket at the back of the cooker base. Ensure the connection is tight.  
Connect the power lead to a 220-240 V power source.  
The cooker goes to Standby mode and the display indicates **OFF**.
4. Place and close the lid as described in [Pressure Control Features–Pressure Locking Lid](#).
5. Press **Yogurt** to select the Yogurt Smart Programme.
6. Press the quick release button down until it clicks and locks into the **Vent** position.
7. Press **Yogurt** again to cycle to the **More** option.  
The display indicates **boil**.
8. After **10 seconds** the cooker begins heating.
9. When pasteurisation completes, the display indicates **End**.
10. Remove the lid and use a thermometer to check the temperature.

*Note: Milk must reach a minimum of 72°C (161°F) for pasteurisation to occur.*

### Add Starter Culture

1. Allow pasteurised milk to cool to just below 43°C (110°F).
2. Add a starter culture to the milk according to package instructions.

*Note: If using plain yogurt as a starter, ensure that it contains an **active culture**. Mix in 30 mL of yogurt per 3.8 Litres of milk, or follow a trusted recipe.*

3. Place and close the lid as described in [Pressure Control Features–Pressure Locking Lid](#).

# Using Non-Pressure Cooking Smart Programmes

---

## Ferment Yogurt

1. Press **Yogurt** to select the Yogurt Smart Programme.
2. Press the quick release button down until it clicks and locks into the **Vent** position.
3. Press **Yogurt** again to cycle to the **Normal** option.  
The display indicates **08:00**.
4. Use the **- / +** buttons to adjust the fermentation time if desired.
5. After **10 seconds** the cooker begins heating. The display timer counts up to the set time from **00:00**.
6. When fermentation completes, the cooker beeps and displays **End**.

Setting	Suggested Use	Notes
<b>Less</b>	For lower temperature fermentation (e.g., Jiu Niang, a sweet fermented glutinous rice dessert)	Default fermentation time is <b>24</b> hours. Adjust fermentation time based on recipe.
<b>Normal</b>	Fermenting milk after culture has been added	A longer fermentation will result in tangier yogurt. Adjust as desired up to <b>99</b> hours and <b>30</b> minutes.
<b>More</b>	Pasteurising milk	Pasteurisation time is preset and cannot be adjusted. Display indicates <b>boil</b> while programme is running. For extra thick yogurt, pasteurise milk twice.

# Using Non-Pressure Cooking Smart Programmes

---

## Sous Vide

Sous Vide cooking brings vacuum-sealed food to a very accurate temperature and maintains that temperature for a period of time to achieve high quality, consistently delicious results.

Set the cooking temperature from a range of 25–90°C. You'll need:

- Tongs
- Thermometer
- Airtight or Vacuum Sealed Food Pouches
- Optional: Vacuum sealer

1. Remove the inner pot from the cooker base.
2. Fill the inner pot with warm water up to – **1/2** line, as indicated on the inner pot.
3. Insert the inner pot into the cooker base.
4. Secure the power lead to the base power socket at the back of the cooker base. Ensure the connection is tight. Connect the power lead to a 220-240 V power source. The cooker goes to Standby mode and the display indicates **OFF**.
5. Place and close the lid as described in [Pressure Control Features–Pressure Locking Lid](#).

***Note:** The pressure cooking lid is not necessary when cooking sous vide; however, it is recommended for optimal temperature control.*

6. Press the quick release button down until it clicks and locks into the **Vent** position.
7. Press **Sous Vide** to select the Sous Vide Smart Programme.
8. Use the **- / +** buttons to adjust the temperature in increments of 1°C.
9. Press **Sous Vide** again to toggle to cook time setting.
10. Use the **- / +** buttons to adjust the cook time.

***Note:** Cooking time and temperature adjustments are saved to the Smart Programme when cooking begins.*

11. After **10 seconds**, the display shows **On** to indicate that it has begun heating.
12. While the cooker heats, season food as desired. Refer to [Ingredients and Seasonings](#). Separate single servings of food within individual pouches. Remove air and seal tightly.

## Using Non-Pressure Cooking Smart Programmes

---

- The cooker beeps once the water temperature is reached. Remove the lid and immerse the sealed pouches' in the warm water. The pouches contents should be submerged, but the seal should remain above the water line.
- Place and close the lid as described in [Pressure Control Features–Pressure Locking Lid](#).
- For cooking times over 4 hours, check the water level periodically to ensure pouch contents remain submerged. If required, add heated water to the inner pot.

### **CAUTION**

Do not overfill the inner pot. Ensure that total contents (water and food pouches) leave at least 2 inches of space between the brim of the inner pot and the water line.

- Once complete, the display indicates **End**. Open cooker and carefully remove the pouches from water.
- Remove contents from pouches and use a thermometer to check they are done. Follow a recipe or refer to the Sous Vide Cooking Guidelines.

### Reverse Searing

Searing your meat after cooking, rather than before, is a great way to boost flavors. After sous vide cooking, remove the meat from the cooking pouch and gently pat it dry. Then, sear it lightly in the inner pot with the Sauté Smart Programme, or use a pan, blow torch, or grill.

### Ingredients and Seasonings

- Use high quality, fresh ingredients when cooking sous vide to ensure the best possible flavor.
- When seasoning with salt, it is better to use less than you might add normally, especially with meats, poultry, and fish. Instead, add salt to taste after cooking.
- Use garlic powder rather than raw garlic. Raw garlic can become bitter and overpowering when cooked sous vide. Pure and high-quality garlic powder provides the best results.

*Note: Do not use garlic salt in place of garlic powder!*

### Storing Cooked Food

If your dish is not going to be consumed immediately, plunge pouches into ice water to reduce temperature quickly, then keep refrigerated.

# Using Non-Pressure Cooking Smart Programmes

## Sous Vide Cooking Guidelines

Food	Recommended Thickness	Expected Doneness	Cooking Temperature	Minimum Cooking Time	Maximum Cooking Time
<b>Beef and Lamb</b>					
Tender Cuts: Tenderloin, cutlets, sirloin, rib-eye, rump, T-bone, chops	2-5 cm	Rare	50°C	1 hour	4 hours
		Medium-rare	54°C	1.5 hours	4 hours
Tougher Cuts: Blade, chuck, shoulder, shanks, game meats	4-6 cm	Medium	60°C	1.5 hours	4 hours
		Medium-well	63°C	1.5 hours	4 hours
<b>Poultry</b>					
Chicken Breast	3-5 cm	Soft and Juicy	63°C	1.5 hours	4 hours
		Traditionally firm	69°C	1 hour	4 hours
Chicken Thigh	3-5 cm	Juicy and tender	74°C	1 hour	4 hours
		Off-the-bone tender	74°C	4 hours	8 hours
Chicken Leg	5-7 cm	Juicy and Tender	74°C	2 hours	7 hours
Duck Breast	3-5 cm	Soft and Juicy	64°C	2 hours	4 hours
<b>Pork</b>					
Belly	3-6 cm	Traditionally firm	82°C	10 hours	22 hours
Ribs	2-3 cm	Off-the-bone tender	59°C	10 hours	22 hours
Chops	2-4 cm	Pink and juicy	57°C	1 hour	4 hours
		White throughout and juicy	64°C	1 hour	4 hours

## Using Non-Pressure Cooking Smart Programmes

Food	Recommended Thickness	Expected Doneness	Cooking Temperature	Minimum Cooking Time	Maximum Cooking Time
<b>Fish and Seafood</b>					
Fish	2-3 cm	Soft and buttery	43°C	10 minutes	30 minutes
		Translucent / starts to flake	46°C	20 minutes	45 minutes
		Medium-rare	52°C	20 minutes	45 minutes
		Medium, dry	54°C	20 minutes	45 minutes
		Well-done, crumbly	57°C	20 minutes	45 minutes
Shrimp	-	Traditionally firm	60°C	30 minutes	45 minutes
Lobster Tail	-	Soft and buttery	60°C	1 hour	1 hour
Scallops	-	Soft and buttery	60°C	30 minutes	30 minutes
<b>Eggs</b>					
Eggs	Large / Extra Large	Runny	60°C	-	45 minutes
		Soft-boiled	62°C	-	45 minutes
		Medium-boiled	65°C	-	1 hour
		Hard-boiled	73.9°C	-	1 hour
<b>Fruits and Vegetables</b>					
Fruits	-	-	83.9°C	15 minutes	2 hours
Vegetables	-	-	83.9°C	45 minutes	2.5 hours

*Cooking times and temperatures are recommendations only. Always follow a trusted recipe.*



## Care and Cleaning

Clean your Duo Plus after each use.

Unplug your Instant Pot® and let it cool to room temperature before cleaning.

Let all surfaces dry thoroughly before use or storage.

Part	Instruction	Cleaning Method
<b>Accessories</b> <ul style="list-style-type: none"> <li>• Steam Rack</li> <li>• Condensation Collector</li> </ul>	<ul style="list-style-type: none"> <li>• Wash after each use.</li> <li>• Never use harsh chemical detergents, powders or scouring pads on accessories.</li> <li>• For dishwasher, place on top rack.</li> <li>• Empty and rinse condensation collector after each use.</li> </ul>	Dishwasher Safe* and Hand Washable  *Some discoloration may occur after machine washing, but this will not affect the cooker's safety or performance.
<b>Lid and Parts</b> <ul style="list-style-type: none"> <li>• Anti-Block Shield</li> <li>• Sealing Rings</li> <li>• Steam Release Valve</li> <li>• Float Valve</li> <li>• Silicone Cap</li> </ul>	<ul style="list-style-type: none"> <li>• Wash after each use with hot water and washing up liquid and allow to air dry, or place on top rack of dishwasher.</li> <li>• Remove all small parts from lid before washing.</li> <li>• With steam release valve and anti-block shield removed, clean interior of steam release pipe to prevent clogging.</li> <li>• To drain water from the lid after dishwashing, take the lid handle and hold the lid vertically over a sink, then turn it 360° – like turning a steering wheel.</li> <li>• After cleaning, store the lid upside down on the cooker base.</li> <li>• Store sealing rings in a well-ventilated area to decrease residual odour from highly flavoured meals. To eliminate odours, add 250 mL of water and 250 mL of white vinegar to inner pot and run Pressure Cook for 5-10 minutes, then QR pressure.</li> </ul>	
<b>Inner Pot</b>	<ul style="list-style-type: none"> <li>• Heavy hard water staining may require a vinegar dampened sponge and some scrubbing to remove.</li> <li>• If there is tough or burned food residue at the bottom, soak in hot water for a few hours for easy cleaning.</li> <li>• Wash after each use.</li> <li>• Ensure all exterior surfaces are dry before placing in cooker base.</li> </ul>	
<b>Detachable Power Lead</b>	<ul style="list-style-type: none"> <li>• Use a barely damp cloth to wipe any particles off power lead.</li> </ul>	Damp Cloth Only
<b>Cooker Base</b>	<ul style="list-style-type: none"> <li>• Wipe the inside of the outer pot as well as the condensation rim with a barely damp cloth, and allow to air dry.</li> <li>• Clean cooker base and control panel with a soft, barely damp cloth or sponge.</li> </ul>	

*\*Some discoloration may occur after machine washing, but this will not affect the cooker's safety or performance.*

### ⚠ WARNING

Ensure heating element remains dry at all times.

Do not immerse cooker base in water or attempt to run through dishwasher.

Do not submerge power lead at any time.

Do not wet pins of power lead.

# Troubleshooting

**Register your product today.**

Contact Customer Care: **+44 (0) 3331 230051**

[support@instantpot.co.uk](mailto:support@instantpot.co.uk)

Problem	Possible Reason	Solution
Difficulty closing lid	Sealing ring not properly fitted	Re-position sealing ring, ensure it is snug behind sealing ring rack.
	Float valve in the popped-up position	Gently press the float valve downward with a long utensil.
	Contents in cooker are still hot	Press quick release button down until it clicks into <b>Vent</b> position, then lower lid onto cooker base slowly, allowing heat to dissipate.
Difficulty opening lid	Pressure inside the cooker	Release pressure according to recipe; only open lid after float valve has dropped down.
	Float valve stuck at the popped-up position due to food debris or residue	Ensure steam is completely released by quick-releasing pressure, then press float valve gently with a long utensil. Open lid carefully and thoroughly clean float valve, surrounding area, and lid before next use.
	 <b>WARNING</b> Contents may be under pressure; to avoid scalding injury, do not attempt to force lid open.	
Inner pot is stuck to lid when cooker is opened	Cooling of inner pot may create suction, causing inner pot to adhere to the lid	To release the vacuum, press quick release button down until it clicks into <b>Vent</b> position.
Steam leaks from side of lid	No sealing ring in lid	Fit sealing ring.
	Sealing ring damaged or not properly installed	Replace sealing ring.
	Food debris attached to sealing ring	Remove sealing ring and clean thoroughly.
	Lid not closed properly	Open, then close lid.
	Sealing ring rack is warped or off-centre	Remove sealing ring from lid, check sealing ring rack for bends or warps. Contact <a href="#">Customer Care</a> .
	Inner pot rim may be misshapen	Check for deformation and contact <a href="#">Customer Care</a> .

# Troubleshooting

Problem	Possible Reason	Solution
Float valve does not rise	Food debris on float valve or float valve silicone cap	Remove float valve from lid and clean thoroughly; perform <b>Initial Test Run</b> to check for function and record findings. Contact <b>Customer Care</b> .
	Not enough liquid in the inner pot	Check for scorching on bottom of inner pot. Add thin, water-based liquid to the inner pot according to its size: 3 Litre: 250 mL 5.7 Litre: 375 mL 8 Litre: 500 mL
	Float valve silicone cap damaged or missing	Fit or replace float valve.
	Float valve obstructed by lid-locking mechanism	Tap float valve with a long utensil. If the float valve does not drop, turn the cooker off. Contact <b>Customer Care</b> .
	No heat in the inner pot	Perform <b>Initial Test Run</b> to check operation, and record findings. Contact <b>Customer Care</b> .
	Inner pot base may be damaged	Perform <b>Initial Test Run</b> to check operation, and record findings. Contact <b>Customer Care</b> .
Small amount of steam leaking/hissing from steam release valve during cook cycle	Quick release button not in <b>Seal</b> position	Flick quick release button to ensure it is in the <b>Seal</b> position.
	Cooker is regulating excess pressure	This is normal; no action required.
Steam gushes from steam release valve when quick release button is in <b>Seal</b> position	Not enough liquid in the inner pot	Add thin, water-based liquid to the inner pot according to its size: 3 Litre: 250 mL 5.7 Litre: 375 mL 8 Litre: 500 mL
	Pressure sensor control failure	Contact <b>Customer Care</b> .
	Steam release valve not seated properly	Flick quick release button to ensure it is in the <b>Seal</b> position.
Display remains blank after connecting the power lead	Bad power connection or no power	Inspect power lead for damage. If damage is noticed, contact <b>Customer Care</b> . Check outlet to ensure it is powered.
	Cooker's electrical fuse has blown	Contact <b>Customer Care</b> .

# Troubleshooting

Problem	Possible Reason		Solution
Error code appears on display and cooker beeps continuously	C1 C2 C6 C6H C6L	Faulty sensor	Contact Customer Care. <b>+44 (0) 3331 230051</b> <a href="mailto:support@instantpot.co.uk">support@instantpot.co.uk</a> <a href="https://www.instantpot.co.uk/#Chat">instantpot.co.uk/#Chat</a>
	C5	Temperature is too high because inner pot is not placed in the cooker base	Press <b>Cancel</b> and wait for heating element to cool; ensure there are no foreign objects in cooker base; insert or reposition inner pot in cooker base and re-enter commands.
		Temperature is too high because there is no water in inner pot	Check for scorching on bottom of inner pot. Add thin, water-based liquid to the inner pot according to its size: 2.8 Litres: 250 mL 5.7 Litres: 375 mL 8 Litres: 500 mL
	C7 or NoPr	Heat element has failed	Contact <a href="#">Customer Care</a> .
		Not enough liquid	Add thin, water-based liquid to the inner pot according to its size: 2.8 Litres: 250 mL 5.7 Litres: 375 mL 8 Litres: 500 mL
		Quick release button is in the <b>Vent</b> position	Flick quick release button to ensure it is in the <b>Seal</b> position.
	Lid	Lid is not in the correct position for the selected programme	Open and close the lid. Do not use a lid when using <b>Sauté</b> .
	OvHt / Burn / Food burn	High temperature detected at bottom of inner pot; cooker automatically reduces temperature to avoid overheating	Starch deposits at the bottom of the inner pot may have blocked heat dissipation. Turn the cooker off, release pressure according to the recipe, and inspect the bottom of the inner pot.
	PrSE	Pressure has accumulated during a non-pressure cooking programme	Press quick release button down until it clicks into <b>Vent</b> position.
	Occasional clicking or light cracking sound	The sound of power switching and expanding pressure board when changing temperatures	
Bottom of the inner pot is wet		Wipe exterior surfaces of inner pot. Ensure heating element is dry before inserting inner pot into cooker base.	

Any other servicing should be performed by an authorised service representative.

# Warranty

---

## Limited Warranty

Earlyview Ltd., an authorised distributor of Instant Brands, Inc., and Instant Brands Inc. (collectively, the "Company") warrant this appliance to be free from defects in workmanship and material, under normal household use, for a period of one (1) year from the date of original purchase. This Limited Warranty extends only to the original purchaser and use of the appliance in the UK. This warranty does not cover appliance use outside of the UK.

Proof of original purchase date and, if requested, return of your appliance is required to obtain service under this Limited Warranty. Provided that this appliance is operated and maintained in accordance with the written instructions included with the appliance (which are also available at [instantpot.co.uk](http://instantpot.co.uk)), the Company will, at its sole discretion, either: (i) repair defects in materials and workmanship; or (ii) replace the appliance. In the event the appliance is replaced, the Limited Warranty on the replacement appliance will expire 12 months from the date of original consumer purchase.

The Company is not responsible for shipping costs for warranty service.

## Limitation and Exclusions

Any modification or attempted modification to your appliance may interfere with the safe operation of the appliance and may result in serious injury and damage. Any modification or attempted modification to your appliance or any part thereof will void the warranty, unless such modification(s) or alteration(s) were expressly authorised by the Company.

This warranty does not cover (1) normal wear and tear; (2) damage resulting from negligent, unreasonable or misuse of the appliance, improper assembly or disassembly, use contrary to the operating instructions, failure to provide reasonable and necessary maintenance, Acts of God (such as fire, flood, hurricanes and tornadoes), or repair or alteration by anyone, unless expressly directed and authorised by the Company; and (3) repairs where your appliance is used for other than normal household use and in a manner contrary to published user or operator instructions.

To the extent permitted by applicable law, the liability of the Company, if any, for any allegedly defective appliance or part shall be limited to repair or replacement of the appliance or part thereof, and shall not exceed the purchase price of a comparable replacement appliance. Except as expressly provided herein and to the extent permitted by law, (1) the Company makes no warranties, conditions or representations, express or implied, usage, custom of trade or otherwise with respect to the appliance or parts covered by this warranty and (2) the Company shall not be responsible or liable for indirect, incidental, or consequential damages arising out of or in connection with the use or performance of the appliance or damages with respect to any economic loss, loss of property, loss of revenues or profits, loss of enjoyment or use, costs of removal, installation or other consequential damages of any nature or kind.

You may have rights and remedies under applicable laws, which are in addition to any right or remedy which may be available under this limited warranty.

# Warranty

---

## Disclaimer of Implied Warranties

Please visit [www.instantpot.co.uk/support/register](http://www.instantpot.co.uk/support/register) to register your appliance. You will be asked to provide your name, your email address, the store name, date of purchase, model number and serial number (both of which are found on the appliance). This registration will enable us to keep you up to date with product developments, recipes and contact you in the unlikely event of a product safety notification. By registering, you acknowledge that you have read and understood the instructions for use and warnings accompanying the appliance.

## Warranty Service

- Your name, email address or phone number
- A copy of the original purchase receipt with order number, model and serial number
- Description of the product defect, with pictures or video if possible

## Contact Information

Instant Pot / Earlyview Ltd

Unit 5 Hershaw Farm Business Park, Kitsmead Lane,

Chertsey, Surrey KT16 0DN, UK Email: [support@InstantPot.co.uk](mailto:support@InstantPot.co.uk) Telephone: 03331 230051

This warranty was last updated on 1 September 2019 for all products sold from [1 November 2019].

If your product comes with our older warranty version, your warranty will continue to be honoured.

## Recycling

This appliance complies with the WEEE Directive 2012/19/EU on the disposal of electrical and electronic equipment (WEEE). This appliance complies with the European directive for electromagnetic compatibility (EMC) 2014/30/EU and its revisions, as well as Low Voltage Directive (LVD) 2014/35/EU and its revisions.

This marking indicates that this product should not be disposed of with other household waste throughout the EU. To prevent possible harm to the environment or human health from uncontrolled waste disposal, recycle it responsibly to promote the sustainable re-use of material sources. To return your used device, please use the return and collection systems or contact Customer Care for further recycling and WEEE information.



# Instant Pot®

Instant Brands Inc.  
11-300 Earl Grey Dr., Suite 383  
Ottawa, Ontario  
K2T 1C1, Canada

Earlyview Ltd (Instant Pot Official Distributor)  
Unit 5 Hershaw Farm Business Park  
Kitsmead Lane  
Chertsey, Surrey  
KT16 0DN, UK

Register your product today at:

[www.instantpot.co.uk/support/register](http://www.instantpot.co.uk/support/register)

Contact Customer Care:

+44 (0) 3331 230051

[support@instantpot.co.uk](mailto:support@instantpot.co.uk)

[instantpot.co.uk](http://instantpot.co.uk)

[instantpot.co.uk/instant-pot-shop](http://instantpot.co.uk/instant-pot-shop)

Join the Official Instant Pot Community:

[www.facebook.com/groups/InstantPotUKCommunity](https://www.facebook.com/groups/InstantPotUKCommunity)

Download Free App:



 @instantpotUK

 @InstantPotUK

 @instantpotuk

Made in China

Copyright © 2020 Instant Brands™ Inc

629-0104-02