

BRASQ[®]

USER INSTRUCTION LAMINATOR A3

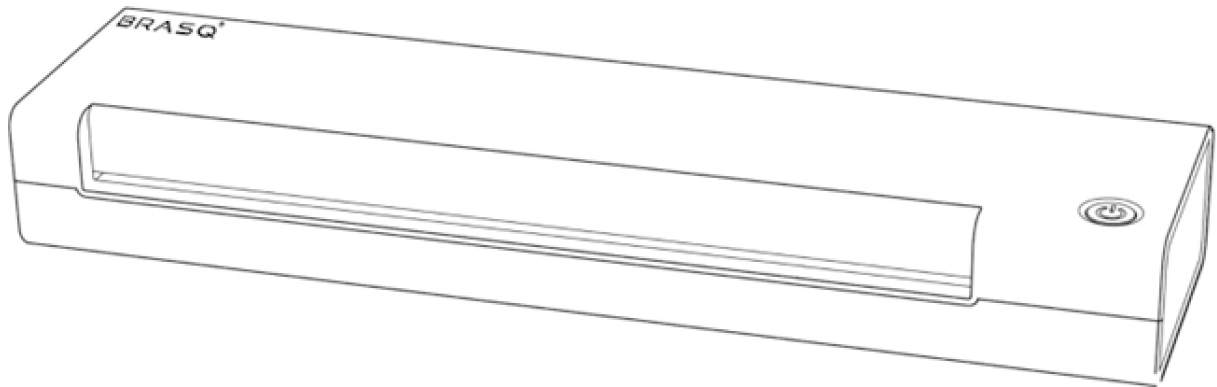

INSTALLATION AND OPERATION:

1

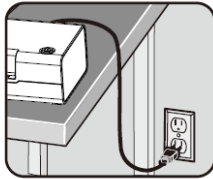

1.Plug in the power socket.

4

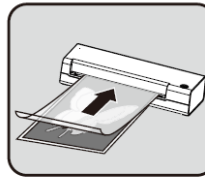

Place pouch, (sealed edge first), into laminator entry. Keep pouch straight.

2

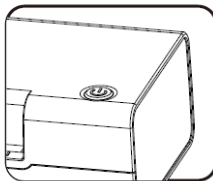

switch ON the laminator by pressing the POWER switch, the LED inside the power switch will light on in red color, it will take about 2.5 – 4 minutes to change to green color, then it is ready to laminate. This laminate can do 70mic and 125 mic pouches.

5

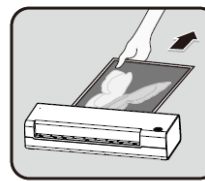

To prevent jamming, immediately remove laminated item from back of machine. Let item cool on flat surface for several seconds.

3

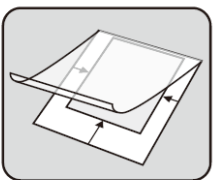

Place item inside pouch against the sealed edge. To prevent jamming, use a carrier when item is smaller than the pouch.

6

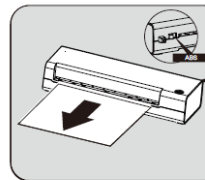

In case there is a jamming, press the Jam Release Lever and pull out the laminating pouches.

KEY PARTS:

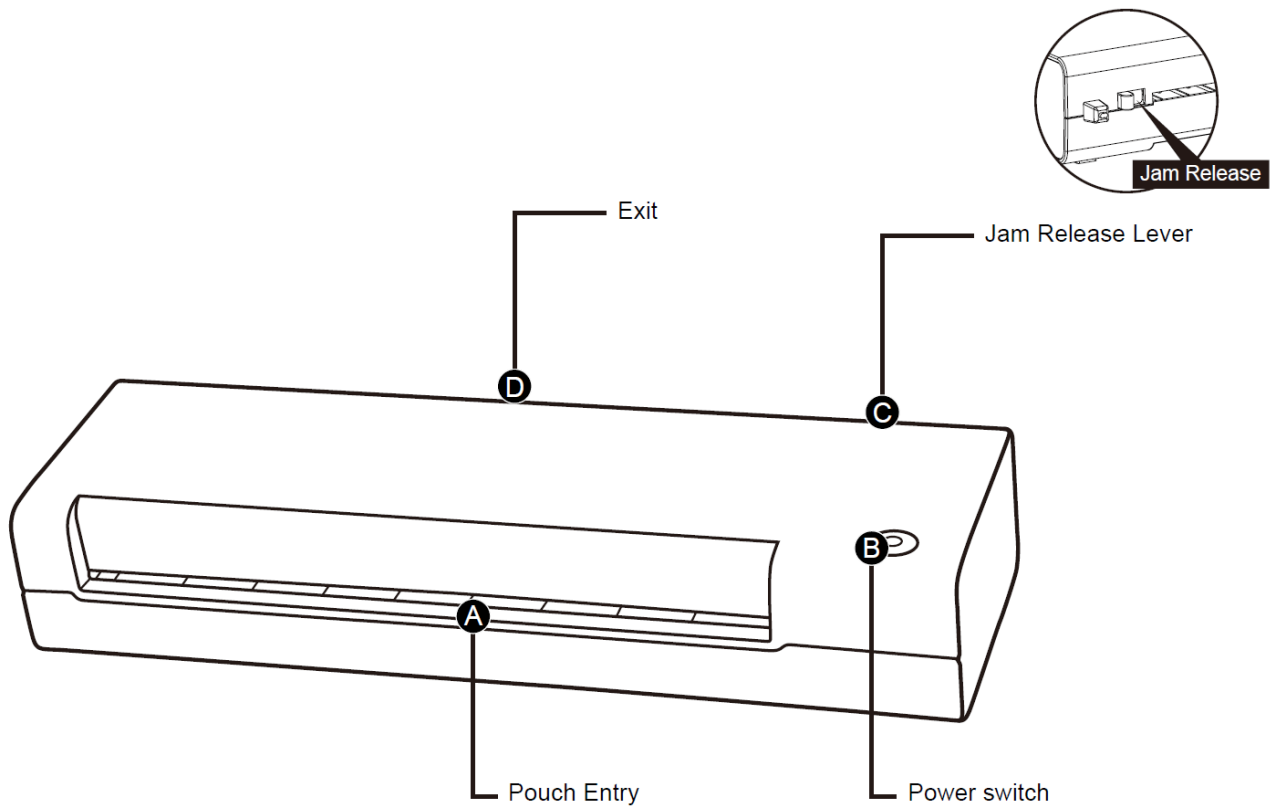

SPECIFICATIONS :

Max. Laminating Width: A3 size

Pouches Thickness: 70 – 125 micron

Heat Up Time: 2.5 - 4 Minutes

Approximate Cool Down Time: 60 Minutes

Lamination Speed: 25 cm /Minute

SAFETY INSTRUCTIONS :

(READ BEFORE USE!)

- The socket-outlet shall be installed near the equipment and shall be easily accessible.
- To prevent electrical shock, do NOT use laminator close to water and do NOT spill water on laminator, electric cord, or wall socket.
- Do not leave electric cord in contact with a warm surface.
- Do not leave electric cord hanging from a cupboard or shelf.
- Do not use laminator if electric cord is damaged.
- Do not laminate metal objects.
- Always supervise children during laminator operation.
- Keep pets away from laminator while in use.
- Switch off and unplug laminator when not in use.
- Do not open or attempt to repair the laminator yourself, as this could result in electric shock and will void your warranty. Contact Customer Service if you have questions. Please note the warranty does not apply in cases of abuse, mishandling or unauthorized repair.

Tips:

- Always put item in a pouch. Never laminate an empty pouch.
- Trim excess pouch material from around your item after laminating and cooling.
- Before laminating valuable items, do a test run with an item similar in size and thickness.
- Use a dry-erase marker for writing on laminated pouches.

Laminating capacity:

Our product is a personal laminator designed for hot pouches lamination. The minimum laminating thickness is 140 (2x70) microns and the maximum thickness is 250 (2x125) microns.

How to load a laminating pouch:

The laminating pouch is sealed along one side. Open the pouch and place the paper to be laminated centrally inside the pouch as close to the sealed edge as possible. Ensure there is an equal border all-round the paper (eg: A4 paper should have a 3mm border). The sealed edge (not the open edges) is placed into the entry slot to start the lamination process.

Warranty & service:

Never service the product yourself. The appliance is guaranteed for 12 months from date of purchase, subject to normal use. If the laminator is under warranty then return it to the point of purchase for replacement or repair.