



IDA-430

denver.eu

03/2023



Safety information

Please read the safety instructions carefully before using the product for the first time and keep the instructions for future reference.

1. This product is not a toy. Keep it out of reach of children.
2. Keep product out of the reach of children and pets to avoid chewing and swallowing.
3. Never use old and new batteries or different types of batteries together. Remove the batteries when you are not using the system for a longer period of time. Check the polarity (+/-) of the batteries when inserting them in the product. Wrong positioning can cause an explosion. Batteries are not included.
4. Product operating and storage temperature is from 0 degree Celsius to 40 degree Celsius. Under and over this temperature might affect the function.
5. Never open the product. Touching the inside electrics can cause electric shock. Repairs or service should only be performed by qualified personnel.





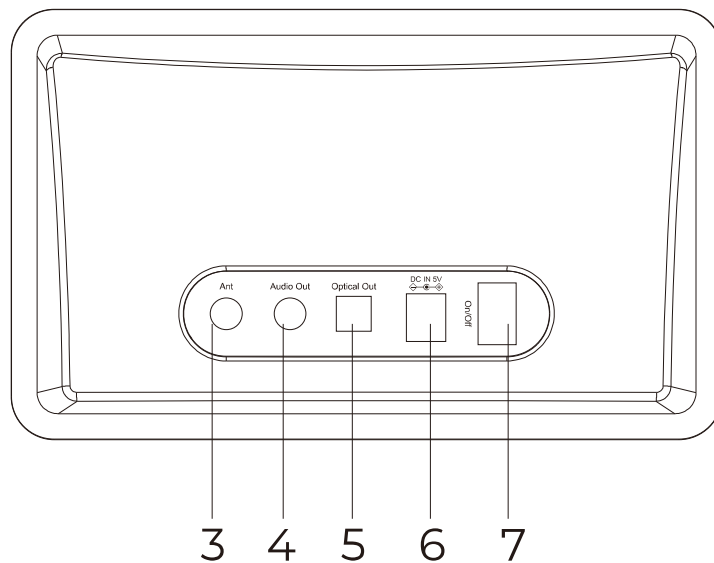
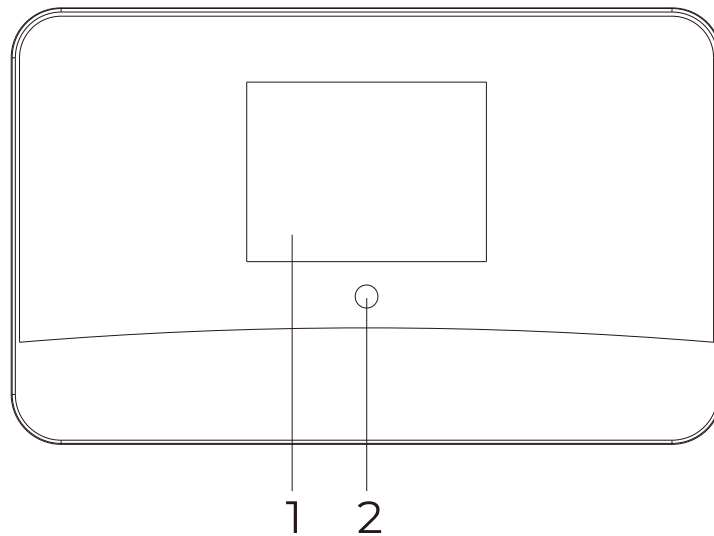











6. Do not expose to heat, water, moisture, direct sunlight!
7. Bluetooth wireless technology operates within a range of about 10 m (30 feet). The maximum communication distance may vary depending on the presence of obstacles (people, metal objects, walls, etc.) or the electromagnetic environment.
8. Microwaves emitting from a Bluetooth device may affect the operation of electronic medical devices.
9. The unit is not waterproof. If water or foreign objects enter the unit, it may result in fire or electric shock. If water or a foreign object enters the unit, stop use immediately.
10. The direct plug-in adapter is used as disconnect device, the disconnect device shall remain readily operable. So, make sure there is space around the power outlet for easy access.
11. Do not use non original accessories together with the product as this can make the product functionality abnormal.

Location of controls



1. 2.8" TFT color screen
2. Infrared remote sensor
3. Wire antenna input socket
4. 3.5 mm audio out socket
5. Optical output connector
6. DC IN socket
7. Power ON/OFF switch

Remote control

1.  : Mute
2. 0-9: Number/characters
3.  : Preset the current playing station to Favorite.
4.  : Cursor up
5.  /  : Cursor left / back
6.  : Alarm button
7.  : Sleep Timer
8. Mode: Switch between radio modes
9.  : Home
10.  : Previous
11.  : Access network info of the radio unit
12.  : Standby and Operation
13.  : Recall the favorite list.
14. OK: confirm button
15.  : Cursor right
16.  : Cursor down
17. Vol+: Volume up
18. Vol-: Volume down
19. EQ: Equalizer
20.  : Next
21.  : Play/Pause
22. Dimmer
23. Info

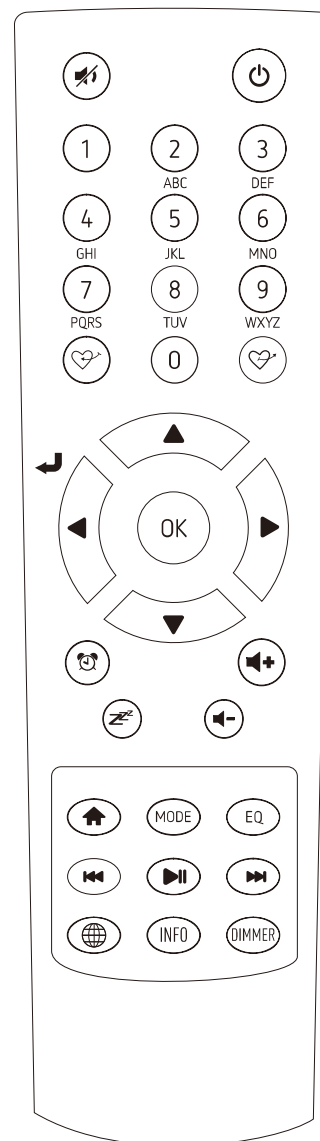

To start up

- Plug the DC adaptor in and switch the Power on/off switch (on the rear cabinet) to ON. The adaptor will turn on automatically.
- Connect external powered speakers to optical output or RCA with a 3.5mm plug.

Network setup

Wi-Fi

If this is the first time use, the Configure Network wizard will be displayed.

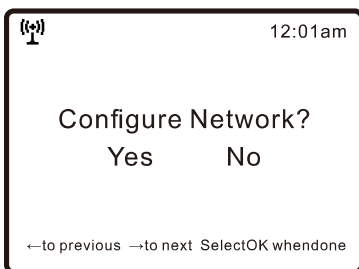

Choose Yes to start configuring network. Navigate by using the arrow buttons to highlight Yes and press **[OK]** to confirm.

Select Network, choose Add wireless network from the list, and press **[OK]** to confirm, and then choose “Scan & select”:

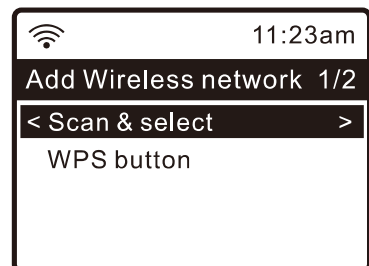
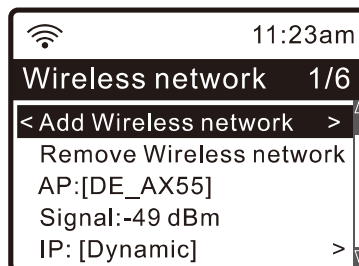
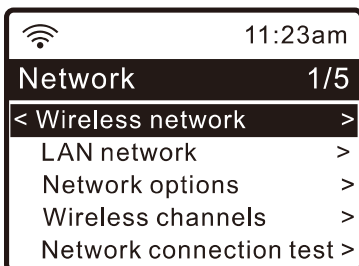

It will start scanning the available wireless networks around. Scroll to your network and confirm the selection. If your wireless network has a security code protected, it will ask you to enter the passphrase/password. Note: The password is case sensitive.

Wi-Fi
signal bar

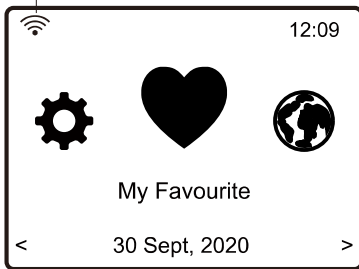

When the Wi-Fi connection is successful, the Connection Complete will be shown briefly. The Wi-Fi signal bar will appear in the top left corner of the display:

Internet radio

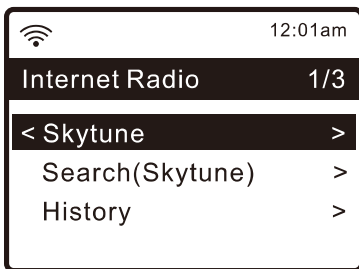

On the Home screen, choose Internet Radio, and you will find the options below:

Skytune

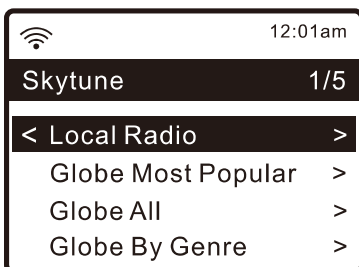

Select Skytune to start enjoying thousands of radio stations from all over the world. You can filter your

search by Region, Music genre, and Talks. The **Local Radio** allows you to access the stations available in your local area quickly.

Media Centre

Music streaming

Once the UPnP/DLNA compatible server is configured to share media files with your radio, you can start music streaming.

- On the main menu, select **Media Centre** and choose **UPnP**. It may take a few seconds for the radio to complete the scan for available UPnP servers. If no UPnP servers are found, it will show **Empty List**. After a successful scan, select your UPnP server. The radio will show the media categories available from the UPnP server, e.g. 'Music', 'Playlists' etc.
- Choose the media files that you wish to play.
- You can set the mode of playback under **Configuration > Playback setup**.

Listening to DAB Radio

Please notice that DAB signal can be weaken

MUCH depending on the type of building you are living in. (fx. It can be hard to catch proper signal when being in a concrete building.)

Signal can also be different in different areas of the country.

Please check your local transmitter to get the best signal in your area.

- Connect the wire antenna supplied with the radio before using DAB and FM radio. If there is DAB in your area, the adaptor can pick up the DAB stations as well.
- On the Home screen (main menu), scroll to **DAB Radio** or use the **[MODE]** button on the remote control to switch to DAB Radio and confirm the selection.
- Choose **DAB full scan** to confirm scanning if this is the first time you use the DAB radio. Confirm to start scanning, and it will show

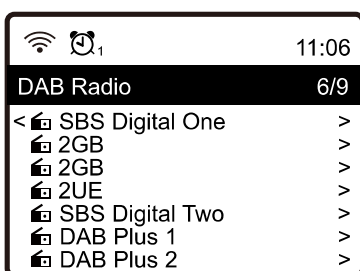

the progress on the number of channels received. When it is done, a preset page will be displayed for your action.

FM Radio

- On the Home screen (main menu), scroll to

FM Radio or use the **[MODE]** button on the remote control to switch to FM Radio. Press **[OK]** to start.

- Choose **FM full scan** to confirm scanning if this is the first time you use the FM radio.

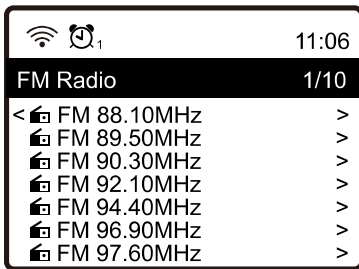

When it is done, the available channels will be saved automatically on presets, and the list will be displayed for your action.

Manual Tune

Press the **⏮ ⏭** button on the remote control to fine tune the frequency. Press the same buttons to skip to the next / preceding available station.

Bluetooth Playback

- Push the **🏠** button to display the selection menu for the different operating modes. Use the up/down button to select the operating mode Bluetooth and push the dial switch.
- Switch your Bluetooth device to which you want to connect the radio on and activate

pairing mode. When the radio is found, your Bluetooth device shows its name IDA-430-XXXX (the XXXX is an identification code for your radio unit).

- Select the radio on your Bluetooth device.
- Start playback on your Bluetooth device.

Note: The Bluetooth range is 10 meters.

Alarm setting

- Choose **Alarm** from the main menu or press the  button on the remote control.
- Select either Alarm 1 or Alarm 2, and choose **Turn on** to activate the Alarm.
- Follow the alarm wizard instructions to set the alarm.

The wizard will guide you through the settings below:

Time — Set the time for the alarm.

Sound — You can choose **Wake to Tone, My Favorite, Wake to FM Radio or Wake to DAB Radio** as the alarm source.

Note: Wake to FM or Wake to DAB Radio.

Only the preset stations can be used for the radio alarm (if the preset scan has been completed).

Wake to My Favorite — Please preset your favorite station before setting this as the alarm source.

Repeat — You can schedule the alarm as you desire - Every day, once or multiple days.

Alarm Volume — Adjust the alarm volume as you like by using the arrow buttons on the remote control.

Alarm duration — Set the alarm duration from the preset options ranging from 30 to 180 minutes. The radio will be turned to standby mode when the selected duration of time is due.

- After the settings above are completed, press the [◀] button to exit and make sure the Alarm is turned on. The Alarm icon will appear on the display if it is activated.

Sleep timer setting

You can set the timer to let the radio go to sleep after the selected timer has elapsed. There are many preset timer options from 15 minutes to 180 minutes.

Alarm Sleep Timer

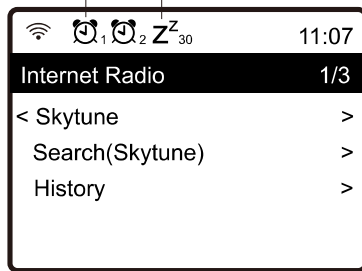

Press [] button on the remote control to set the timer. The icon will appear on the display if the timer is set.

In the Box

- AC-DC adaptor 5V 1A. Voltage 100 - 240V~50/60Hz.
- Remote control (2xAAA batteries not included)
- 3.5 mm wire antenna
- 3.5 mm RCA cable

Manufacturer's name or trade mark, commercial registration number and address	JFEC Electronic Technical Product Inc. 9144190069476483X1 No. 18 Minye Street, No.178 Industrial Zone Zhu Fuling, Tangxia Town DONGGUAN, Guangdong, 523721 China
Model identifier	JF005WR-0500100VH
Input voltage	100-240VAC
Input AC frequency	50/60Hz
Output voltage	5VDC
Output current	1A
Output power	5W
Average active efficiency	$\geq 73.62\%$
Efficiency at low load (10%)	NA
No-load power consumption	$\leq 0.1W$

Please notice - All products are subject to change without any notice. We take reservations for errors and omissions in the manual.

ALL RIGHTS RESERVED, COPYRIGHT
DENVER A/S



denver.eu



Electric and electronic equipment contains materials, components and substances that can be hazardous to your health and the environment, if the waste material (discarded electric and electronic equipment) is not handled correctly.

Electric and electronic equipment is marked with the crossed out trash can symbol, seen above. This symbol signifies that electric and electronic equipment should not be disposed of with other household waste, but should be disposed of separately.

All cities have established collection points, where electric and electronic equipment can either be submitted free of charge at recycling stations and other collection sites, or be collected from the households.

Additional information is available at the technical department of your city.

Hereby, Denver A/S declares that the radio equipment type IDA-430 is in compliance with Directive 2014/53/EU. The full text of the EU declaration of conformity is available at the following internet address: denver.eu and then click the search ICON on topline of website. Write model number: IDA-430. Now enter product page, and RED directive is found under downloads/other downloads.

Operating Frequency Range: 2.412-2.484GHz

DENVER A/S
Omega 5A, Soeften
DK-8382 Hinnerup
Denmark

www.facebook.com/denver.eu

Contact

Nordics

Headquarter

Denver A/S

Omega 5A, Soefte

DK-8382 Hinnerup

Denmark

Phone: **+45 86 22 61 00**

(Push "1" for support)

E-Mail

For technical questions, please write to:

support.hq@denver.eu

For all other questions please write to:

contact.hq@denver.eu

Benelux

DENVER BENELUX B.V.

Barwoutswaarder 13C+D

3449 HE Woerden

The Netherlands

Phone: **0900-3437623**

E-Mail: **support.nl@denver.eu**

Spain/Portugal

DENVER SPAIN S.A

Ronda Augustes y Louis Lumiere, n° 23 –
nave 16

Parque Tecnológico

46980 PATERNA

Valencia (Spain)

Spain

Phone: +34 960 046 883

Mail: support.es@denver.eu

Portugal:

Phone: +35 1255 240 294

E-Mail: denver.service@satfiel.com

Germany

Denver Germany GmbH Service

Max-Emanuel-Str. 4

94036 Passau

Phone: +49 851 379 369 40

E-Mail

support.de@denver.eu

Fairfixx GmbH

Repair and service
Rudolf-Diesel-Str. 3 TOR 2
53859 Niederkassel

(for TV, E-
Mobility/Hoverboards/Balanceboards,
Smartphones & Tablets)

Tel.: +49 851 379 369 69

E-Mail: denver@fairfixx.de

Austria

Lurf Premium Service GmbH

Deutschstrasse 1
1230 Wien

Phone: **+43 1 904 3085**

E-Mail: denver@lurfservice.at

If your country is not listed above, please
write an email to

support@denver.eu



DENVER A/S

Omega 5A, Soefte

DK-8382 Hinnerup

Denmark

denver.eu

facebook.com/denver.eu