

# Users Guide & Installation Handbook



Belling  
Range DF

**belling**<sup>®</sup>

think of everything

## **IMPORTANT NOTICE**

Please note the cooling fan fitted to this appliance is an integral part of its safety and functionality.

When the appliance is installed care must be taken that the cooling fans performance is not impeded by any objects coming into contact with it. (Installation pipes, leads etc)

Care must also be taken that there is sufficient air flow at the rear of the appliance for the cooling fan to run at its optimum efficiency. (Particularly Built In appliances) See clearance dimensions in the installation section of the booklet.

During use the Appliance must never be disconnected from the Mains supply as this will seriously affect the safety and performance of the appliance, particularly in relation to surface temperatures becoming hot and gas operated parts not working efficiently.

The cooling fan is designed to run on after the control knob has been switched off to keep the front of the appliance and the controls cool until the appliance has naturally cooled itself.

# Our Warranty

---

Should you need it . . . .

Inside the paperwork which has come with this appliance, there is a leaflet and card explaining the terms of our extended warranty and guarantee.

In order to apply for a one year guarantee, simply fill in the details on the card and post it off, this will register your appliance.

Should you wish to take out extended warranty, please fill in the details on the leaflet and post this off.

Alternatively, you can register, and apply for extended warranty on line at:

**[www.belling.co.uk](http://www.belling.co.uk)**

If your appliance is covered by the warranty and guarantee, you will not be billed for work undertaken should your appliance be faulty, terms and conditions do apply, so please read through the literature carefully.

Our Customer Care Centre can be called on:

**0844 815 3746**

We aim to answer calls as quickly as possible, and in strict rotation as soon as one of our Customer Care team becomes free.

Please ensure that you have available your appliances model number and serial number, there is a space at the back of this book for recording that information. Alternatively visit the web site.

Outside the UK and Northern Ireland, please contact your local supplier.

# Contents

---

<b>User's Section</b> .....	
Before Using Your Cooker .....	
About Your Cooker .....	
Hob & Cooker Safety .....	
Chip Pan Fires .....	
Using The Clock / Programmer .....	
Using Your Gas Hob .....	
Using Your Griddle .....	
Using Your Grill .....	
Grilling Guide .....	
Using Your Main Oven(s) .....	
Oven & Grill Functions .....	
Fanned Oven Guide .....	
Cooking Guide .....	
Roasting Guide .....	
General Baking Guide .....	
Using Your Slow Cook Oven .....	
Cleaning Your Gas Hob .....	
Cleaning Your Cavities .....	
Cleaning Your Appliance .....	
Cook Shop .....	
<b>Trouble Shooting</b> .....	
Before You Call .....	
Changing Light Bulbs .....	
<b>Installation Instructions</b> .....	
Installing Your Cooker .....	
<b>Technical Data</b> .....	
<b>Customer Care</b> .....	<b>Back Cover</b>

**If you smell gas:**

Do not try to light any appliance. Do not touch any electrical switch.

Call the Gas Emergency Helpline at TRANSCO on: **0800 111999**

# Before Using Your Cooker

---



Before using this appliance please make sure that you have removed all packaging and wrapping. Some of the furniture inside this appliance may have additional wrapping.



It is also advised that you turn the ovens and/or grill on for a short while, this will burn off any residues left from manufacturing. There may be a smell which accompanies this process - but this is nothing to worry about and is harmless.



We also recommend that you wash the oven shelves, the baking tray, the grill pan, and the grill pan trivet before their first use in hot soapy water, this will remove the protective oil coating.



Although every care has been taken to ensure this appliance has no burrs, or sharp edges, we recommend that you wear protective gloves when installing and moving this appliance. This will prevent any injury.



Our policy is one of constant development and improvement. Strict accuracy of illustrations and specifications cannot be guaranteed. Modification to design and material may be necessary subsequent to publication.



Please bear in mind that not all the sections inside this handbook are relevant to your appliance, but you should read carefully the sections which are relevant before installation and use. This will save you time.



Always use a registered installer for this appliance.



Environmental protection:

Glen Dimplex Home Appliance brands are committed to protecting the environment and operates an Environmental Management System which complies with BS EN ISO 14001.



All packaging with this appliance is recyclable and environmentally friendly.

Please recycle whenever possible - contact your local authority for your nearest recycling centre.

# Hob & Cooker Safety

- ✓ Always ensure that pan bases are dry, and flat before using them on the hob.
- ✓ Always position pans over the centre of the burner, and turn the handles to a safe position so they cannot be knocked or grabbed.
- ✓ Always use pans which are no smaller than 100mm (4"), or larger than 250mm (10").
- ✓ Always take care when removing food from the oven as the area around the cavity may be hot.
- ✓ Always use oven gloves when handling any utensils which have been in the oven as they will be hot.
- ✓ Always make sure that the oven shelves are resting in the correct position in between two runners. Do not place the oven shelves on top of the highest runner, this will lead to spillage and injury if the baking tray, or dish falls.
- ✗ Never use double pans, rimbased pans, old or misshapen pans, or any pan which is not stable on a flat surface.
- ✗ Never leave cooking fat, or oil, unattended.
- ✗ Never use commercial simmering aids, or heat diffusers, as they create excessive heat and can damage the surface of the hob.
- ✗ Never use the hob for any other purpose than cooking food.
- ✗ Plastic cooking utensils can melt if they come into contact with a warm hob. Never leave them close to, or on top of, the hob.
- ✗ Never leave the burner alight without a pan covering it. This causes a fire hazard.
- ✗ Do not place items on the door while it is open.
- ✗ Do not wrap foil around the oven shelves, or allow it to block the flue.
- ✗ Do not drape tea towels near the oven while it is on, this will cause a fire hazard.
- ✗ Do not pull heavy items, such as turkeys, or large joints of meat, out from the oven on the shelf, as they may overbalance and fall.
- ✗ Do not use this appliance to heat anything other than food items, and do not use it for heating the room.



**WARNING: Parts of the appliance may become hot while in use, always make sure that children are supervised when they are near to the appliance.**

Always make sure that the burner caps, rings and pansupports are correctly placed. This will prevent pans becoming unstable while in use, and ensure an uninterrupted gas flow.



Call Customer Care for a service engineers visit if:

- You find over a period of time that the gas oven becomes hotter at a particular temperature - the thermostat may need replacing.
- The cooling fan fails to work.

# Chip Pan Fires

---

## **What causes a chip pan fire?**

- Chip pan fires start when oil or fat overheats and catches fire, or when oil or fat spills on to the cooker because the pan has been filled too high.
- They can also start when wet chips are put into hot oil, making it bubble up and overflow.

## **Preventing a chip pan fire**

- Never fill the pan more than a third full with oil or fat.
- Never leave the pan alone with the heat on - even for a few seconds.
- Dry chips before putting them in the pan.
- Never put chips in the pan if the oil has started smoking. Turn off the heat and leave the oil to cool down, or else it could catch fire.

## **In the event of a chip pan fire**







- If your chip pan does catch fire - don't panic, and don't move the pan. Serious burns are often caused by picking up the pan and running outside with it.
- If it is safe to do so, and you don't have to reach across the pan, turn off the heat.
- Never throw water, or use a fire extinguisher.
- If you can, drape a damp cloth or towel over the pan to smother the flames.
- Leave the pan to cool down for at least half an hour.
- If you can't control the fire yourself, close the door, get out and tell everybody else to get out.
- Call the fire brigade. Don't go back inside whatever the reason.

# Using The Programmer/Clock

Through your programmer you will be able to set the time of day, set the minute minder, and use the semi and fully automatic cooking functions. The programmer is vital to the working of your appliance, and reading this section will make sure that you get the most out of your ovens.

## The programmer buttons (push button timer)

There are three buttons on this type of timer. The table below shows you what their symbols look like, depending on the model type, and what they do.

Symbol	Symbol	What is it?
		Down / Minus Used to decrease cook / end time, remove minutes from the minute minder and adjust the time of day. Also for listening to and setting the alarm tone. There are 3 tones to choose from.
		Up / Plus Used to increase cook / end time, add minutes to the minute minder and adjust the time of day.
		Function button Used to select the functions available on this timer. <b>Press once for: Minute Minder.</b> <b>Press twice for: Cook time</b> <b>Press three times for: End time.</b> How to use these functions is explained later on in this section.

## Setting the time of day (push button timer)

- Press the Plus and Minus buttons together for a few seconds, and release.
- The '●' in between the numbers on the LED Display will begin to flash.
- While the '●' is flashing it is possible to adjust the time using the Plus and Minus buttons.
- **Important - Once the time has been set, allow approximately 30 seconds before using any of the other timer functions.** This ensures that the time will remain correct.  
Wait until the clock has finished flashing before attempting to use other functions of the clock

What your timer symbols mean.

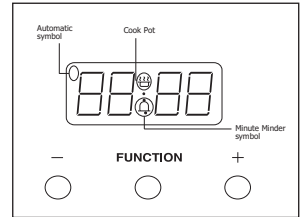

**i** This is a 24 hour clock. Before you do anything with your appliance - you must set the correct time of day.

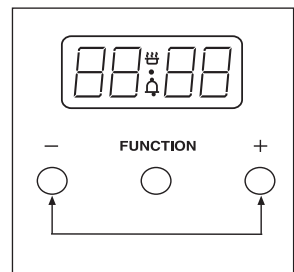



# Using The Programmer/Clock

## Setting an alarm tone (Push button timer)

- Press and hold the minus button.
- Once the minus button is released, the tone is selected.
- You can change tone by repeatedly pressing the minus button (3 tones)

## Setting the minute minder (push button timer)

- To set the Minute Minder, press the centre button once. The bell symbol will appear and start flashing.

**The flashing will last for approx. 5 seconds so the time must be set within this time frame.**

- Use the Plus and Minus button to set the length of time required. Once this has been done, the Minute Minder is set.
- When the desired length of time has counted down the alarm will sound. To cancel the tone, press any of the buttons.
- To cancel the Minute Minder at any time, press the Plus and Minus buttons together.

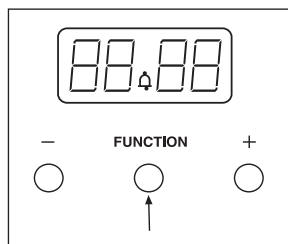

## Semi Automatic Cooking (Push button timer)

**Duration method** (switch off after set time period)

- Press the Function (centre) button twice (This will skip past the Minute Minder function).
- The display will flash the word 'dur', and the 'A' will flash on the left hand side of the display.
- Use the Plus and Minus buttons to set the length of time you want to cook for. **The flashing will last for approx. 5 seconds, so the setting must be done within this time frame or the time of day will show again.**
- Once the duration has been set, the oven will automatically switch off. When the set time has elapsed the alarm will sound. To switch off the alarm, press any button.
- To view any remaining time press the function (centre) button twice.
- To cancel the semi automatic programme at any time, press the plus and minus buttons together.

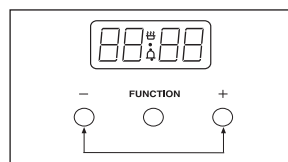
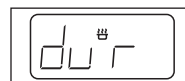
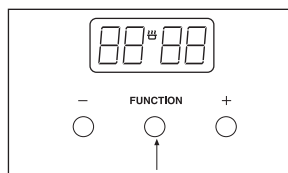

**The End Time method** (Switch off at a set end time)

- Press the Function button three times (This will skip past the Minute Minder and the Duration function)
- The display will flash the word 'End' and the 'A' will flash on the left hand side of the display.

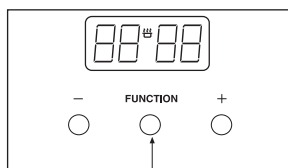

# Using The Programmer/Clock

- Use the Plus and Minus buttons to select the time the oven is required to turn off.
- Once this is done the oven will turn itself off at the pre-selected time. To turn off the alarm press any button.
- To cancel the Semi Automatic programme at any time, press the plus and minus buttons together.

## Fully Automatic Cooking (push button timer)

This function allows the cooker to switch on and off automatically

It requires both the duration and the end time to be entered. The timer will work out the start time and begin cooking.

- Press the Function (centre) button twice, (This will skip past the Minute Minder).
- The display will flash the word 'dur', and the 'A' will flash on the left hand side of the display.
- Use the Plus and Minus buttons to set the length of time you want to cook for. **The flashing will last for approx. 5 seconds so the setting must be set within this time frame or the time of day will show again.**
- Press the Function button three times (skips past the Minute Minder and the Duration functions)
- The display will flash 'End' and the 'A' will flash on the left hand side of the display.
- Use the Plus and Minus buttons to select the time the oven is required to turn off.
- Set the temperature of the oven and place the food inside. The timer will calculate the start time.
- When this is done, the oven will turn itself off at the time you have selected. To switch off the alarm, press any button.
- To cancel the automatic programme at any time, press the plus and minus buttons together.

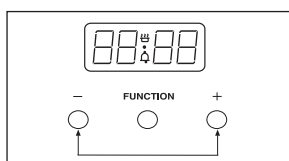
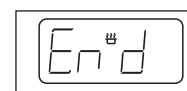
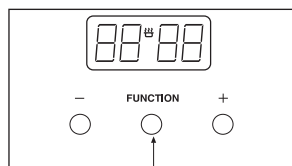
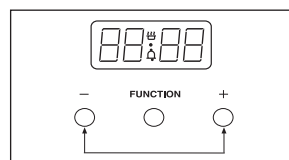
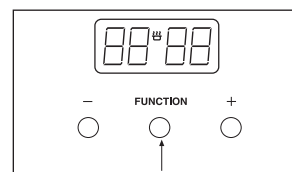
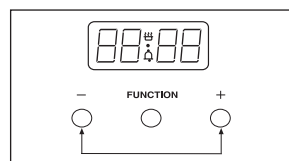
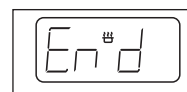

The automatic cooking symbol will appear to show that the oven is no longer in manual mode but in automatic mode.



**Important:** Once the oven has switched itself off please make sure you turn to oven controls to the 'off' position and set the oven to manual by pressing the Cook Time and Ready Time buttons / icons together.









**Important:** Remove food as soon as it is cooked.

# Using The Programmer/Clock

## The programmer Icons (touch control timer)

There are three icons on this type of timer. The table below shows you what the symbols look like, depending on the model type, and their functions.

**Note - some functions require you to 'touch and hold' an icon for a few seconds, whilst others require you just to 'touch' the icon without holding it.**

Symbol	Symbol	What is it?
		Down / Minus Used to decrease cook / end time, remove minutes from the minute minder and adjust the time of day. Also for listening to and setting the alarm tone. There are 3 tones to choose from.
		Up / Plus Used to increase cook / end time, add minutes to the minute minder and adjust the time of day.
		Function icon Used to select the functions available on this timer. <b>Press once for: Minute Minder and to set the time of day.</b> <b>Press twice for: Cook time</b> <b>Press three times for: End time.</b> How to use these functions is explained later on in this section.

## Setting the time of day (touch control timer)

- Touch and hold the centre icon for a few seconds and release.
- The '●' in between the numbers on the LED Display will begin to flash.
- While the '●' is flashing you can adjust the time using the Plus and Minus icons.

**Please note:** the hours and minutes adjust quickly

- **Important - Once the time has been set, allow approximately 30 seconds before using any of the other timer functions. This ensures that the time will remain correct.**

## Setting an alarm tone (touch control timer)

- Touch and hold the Plus and Minus icons simultaneously until the '●' flashes and you hear a beep. Then press the centre icon.
- Touch the minus icon to select the tone.
- You can change the tone by repeatedly touching the minus icon (3 tones)

What your timer symbols mean.

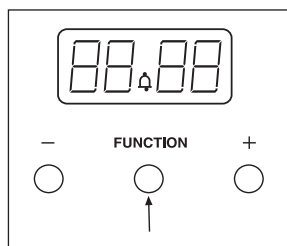
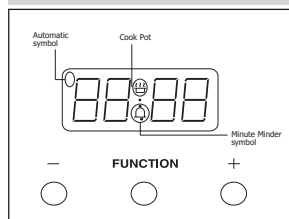

# Setting the Programmer

## Setting the minute minder (touch control timer)

- To set the Minute Minder, touch and hold the centre icon. The bell symbol will appear and start flashing.  
**Important - The flashing will last for approx. 5 seconds so any setting must be set within this time frame.**
- Use the Plus and Minus icons to set the length of time required. Once this has been done, the Minute Minder is set.
- When the desired length of time has counted down the alarm will sound. To cancel the tone, touch and hold any of the icons.
- To cancel the Minute Minder at any time, press and hold the Plus and Minus icons together.

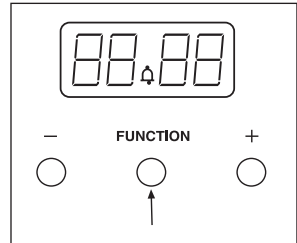

## Semi Automatic Cooking (Touch control timer)

### Duration method (switch off after set time period)

- Touch and hold the Function (centre) icon. The bell will flash and beep. Touch the function icon again (This will skip past the Minute Minder function).
- The display will flash the word 'dur', and the 'A' will flash on the left hand side of the display.
- Use the Plus and Minus icons to set the length of time you want to cook for. **The flashing will last for approx. 5 seconds, so the setting must be done within this time frame or the time of day will show again.**
- Once the duration has been set, the oven will automatically switch off. When the set time has elapsed the alarm will sound. To switch off the alarm, press any icon.
- To view any remaining time touch and hold the function (centre) icon and touch again.
- To cancel the semi automatic programme at any time, press the plus and minus icons together.

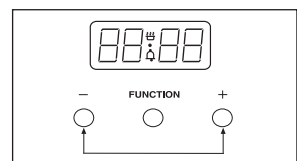
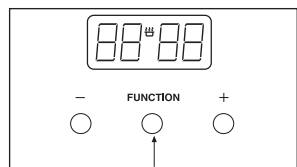
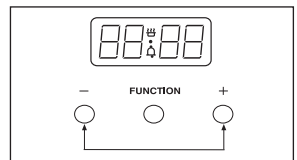
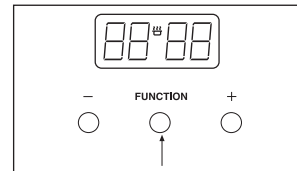

### The End Time method (Switch off at a set end time)

- Touch and hold the Function icon. The bell will flash and beep. Touch the function icon again - twice (This will skip past the Minute Minder and the Duration function)
- The display will flash the word 'End' and the 'A' will flash on the left hand side of the display.
- Use the Plus and Minus icons to select the time the oven is required to turn off.
- Once this is done the oven will turn itself off at the pre-selected time. To turn off the alarm press any icon.
- To cancel the Semi Automatic programme at any time, press the plus and minus icons together.

# Setting the Programmer

## Fully Automatic Cooking (Touch Control timer)

This function allows the cooker to switch on and off automatically

It requires both the duration and the end time to be entered. The timer will work out the start time and begin cooking.

- Touch and hold the Function (centre) icon. The bell will flash and beep. Touch the function (centre) icon again. (This will skip past the Minute Minder).
- The display will flash the word 'dur', and the 'A' will flash on the left hand side of the display.
- Use the Plus and Minus icons to set the length of time you want to cook for. **The flashing will last for approx. 5 seconds so any setting must be set within this time frame or the time of day will show again.**
- Touch the Function icon again (skips past the Minute Minder and the Duration functions)
- The display will flash 'End' and the 'A' will flash on the left hand side of the display.
- Use the Plus and Minus icons to select the time the oven is required to turn off.
- Set the temperature of the oven and place the food inside. The timer will calculate the start time.
- When this is done the oven will turn itself off at the time you have selected. To switch off the alarm, press any icon.
- To cancel the automatic programme at any time, press the plus and minus buttons together.

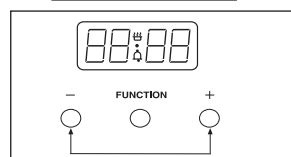
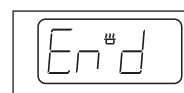
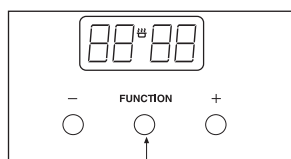
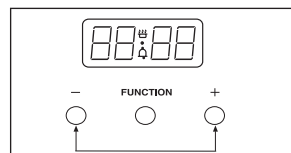
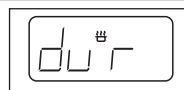
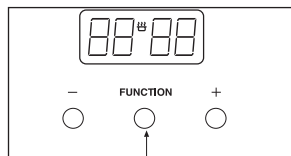

**i** The automatic cooking symbol will appear to show that the oven is no longer in manual mode but in automatic mode.

**i** **Important:** Once the oven has switched itself off please make sure you turn to oven controls to the 'off' position and set the oven to manual by pressing the Cook Time and Ready Time buttons / icons together.

**i** **Important:** Remove food as soon as it is cooked.

# Using Your Gas Hob

## Hob Ignition

Models without thermocouples:

- To turn on, place your pan onto the pansupports above the burner you wish to use.
- Push in and turn the selected control knob anticlockwise, to the full on symbol.
- If your hob has an ignition button or switch on the fascia, press it in until your burner lights.
- If your hob has automatic ignition it will spark next to the burner when you push in the control knob.
- To simmer, turn the control knob to the small flame symbol. This will ensure that the flame is just large enough to gently heat the contents of the pan.
- To turn off, turn the control knob clockwise to the 'off' position.
- Always make sure that your pans are placed correctly on the burners as shown, and do not allow the flame to extend over the base of the pan.

Models with thermocouples:  
ignition as above, but:

- Hold the control knob in for 15 seconds. Do not hold the control knob in for any longer than 15 seconds. If the burner fails to light within this time, release the control knob and wait one minute before attempting to re-ignite.

## Energy Saving

- Position pans centrally over the elements.
- Only heat the amount of liquid you need.
- Once liquids have been brought to the boil, reduce the heat setting to a simmer.
- Consider using a pressure cooker if possible.
- Vegetables in small pieces will cook quicker.
- Use a pan which is a close match to your element size.
- Smaller elements are ideal for simmering and stewing in smaller pans, while the larger elements are ideal for frying and boiling

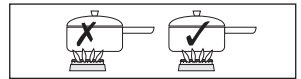
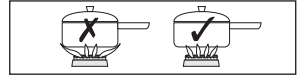

**i** How can I tell if my hob has thermocouples?

**Picture A** below:  
shows a burner without thermocouples.

**Picture B** below:  
shows a burner with thermocouples.

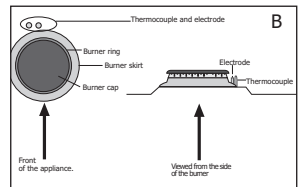
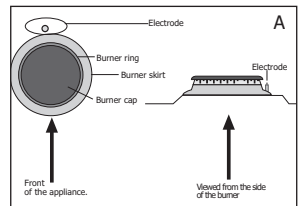

**i** In the event of a power failure, or the ignition not working:  
Push in and turn the control knob to start the gas, then hold a lighted match or taper to the burner until it lights.

**i** Use flat based pans which are the correct size for your burners and suitable for your hob type.  
We recommend the following sizes:  
100mm or 4" min.  
250mm or 10" max.  
Smaller or larger pan sizes may lead to slower cooking times.

# Using Your Griddle (if supplied)

- Only use the griddle which has been approved for use on this appliance. Do not use any other griddle, as this may be hazardous.
- Please read these instructions thoroughly before using the griddle for the first time.

## Before using the griddle for the first time

- Wash the griddle thoroughly in hot soapy water. (see "Cleaning" section).
- Season sparingly with a minimum amount of cooking oil.
- Heat the griddle on full rate for 3 minutes. The griddle plate is now ready for use.

## Using the griddle

- The griddle should only be positioned **front-to-back** over the burners indicated by the griddle symbol on the fascia panel.
- Do not use the griddle over the large burners.
- Place the griddle carefully on the pan support over the burners, using the locating feet on the underside of the griddle. Take care to avoid damage to the surface of the pan supports.
- Before cooking, preheat the griddle for 3 minutes on full rate, which is indicated on the control knobs by a large flame symbol.
- After preheating, turn the control knobs to the small flame symbol.
- The griddle is now ready for cooking.
- Do not use metal implements, as they may damage the non-stick surface.

## Note:

Using a gas appliance results in the production of heat and moisture in the room in which it is installed. Always ensure that the room is well ventilated: keep natural ventilation holes open, or install a mechanical ventilation device (i.e. an extractor hood). Prolonged use of the appliance may call for additional ventilation, for example opening a window, or more effective ventilation such as increasing the level of mechanical ventilation where present.



**Always make sure that children are supervised when they are near to the appliance when it is in use.**



Always allow the griddle to cool completely before moving or cleaning.



### About your griddle:

The griddle is made of quality cast iron, and has a non-stick cooking surface.

Regular seasoning will prolong the life of the griddle and prevent rusting. If the griddle shows signs of rust, wash and re-season.



### Seasoning the griddle:

see the 'Cleaning' section of this handbook.

# Using Your Grill

## Before you start grilling. . . .

Before you use the grill, make sure you have placed the grill shelf in the position you need as once the grill is on you may injure yourself if you try to move the shelf.

- **Do not** close the door while the grill is in use.
- Turn the selector control knob to the heat setting you require.
- To switch off, return the control knob to the 'off' position.
- The cooling fan will come on during use, and may continue to run for some time afterwards.
- To adjust your results, you can turn the grid over, or remove it altogether.

If your grill is a dual grill:

- The dual grill uses all of the top element and is ideal for grilling large quantities of food.
- The single grill uses part of the element only, and is better suited to grill smaller amounts of food.

## The grill pan

This appliance comes with a grill pan, grill pan handle and a grid.

The handle of the grill pan is detachable to allow you to remove it while the pan is in use, this stops it from getting hot.

## To attach the handle:

Place the handle over the narrow edge of the grill pan and slide to the centre as shown in the diagrams.

## Shelf & Grid adjustments

Speed of grilling can be adjusted by changing the shelf position or the turning the grill pan grid.

- High: For thin foods and toasting.
- Low: For thicker meat pieces.

## Aluminium Foil

Never cover the grill pan or grill grid with foil, or allow fat to build up in the grill pan, as this creates a fire hazard.

**i** **Warning:** Accessible parts may become hot when the grill is in use. children should be kept away.

## **i** Types of grill

Fixed rate grill: has a full 'on' setting and 'off'.

Variable rate grill: has adjustable heat settings 1 (low) to 8 (high) or 5 (high) - depending on the model.

Single grill: has one grill element.

Dual grill: has two grill elements which can be used together, or as a single grill.

**i** For best results: Pre-heat the grill for about 3 minutes.

**i** **Please note:** the grill pan handle is designed for sliding the grill pan into and out of the grill cavity. It is not to be used for lifting the pan.

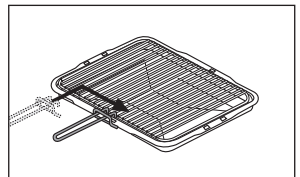
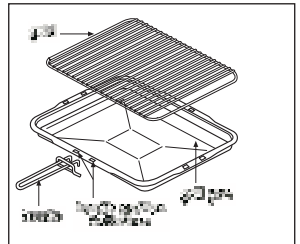



# Using Your Main Oven

---

The main oven may be controlled by the programmer (see The Programmer/Clock for details).

The programmer, if fitted, must be set to manual before it can be used, or programmed.



**Important:** Never place food, or dishes on the base of the main oven, the element is here and it will cause over heating.

## Switching on the fanned / conventional oven











- Use the main oven control to turn your oven on, and select your temperature.
- Your appliance may be fitted with a thermostat indicator light. If it is, then this will come on to show that the oven is heating, and once the temperature is achieved, it will go out.
- To switch off the main oven, simply turn the control knob back to the '●' position.
- The cooling fan will come on during use, and may continue to run for some time afterwards.

## Switching on the multifunction oven (if applicable)

- Use the function control knob to select the function you wish to use - see the functions table for details.  
Note: You can change function during cooking if you wish, as long as the oven is in manual mode.
- Turn the temperature control knob to the temperature you wish to use.
- Your appliance may be fitted with a thermostat indicator light. If it is, then this will come on to show that the oven is heating, and once the temperature is achieved, it will go out.
- To switch off the main oven, simply turn the control knob back to the '●' position.
- The cooling fan will come on during use, and may continue to run for some time afterwards.

# Oven & Grill Functions

The chart below details all of the functions which are available. Your oven may not have all of the functions shown here.

Main Oven Function		Recommended Uses
	Base Heat Only	Used to finish off the bases of food following cooking using the conventional or fanned modes. The base heat can be used to provide additional browning for pizzas, pies and quiche. Use this function towards the end of cooking.
	Top Heat Only	The heat is ideal from browning off the tops of food as it is not as fierce as the grill following conventional or fanned cooking. Provides additional browning for dishes like Lasagna or Cauliflower cheese. Use this function towards the end of cooking.
	Conventional Oven	This function is ideal for traditional roasting. The meat is placed in the middle of the oven, roast potatoes towards the top.
	Intensive Bake	Suitable for food with a high moisture content, such as quiche, bread and cheesecake. It also eliminates the need for baking pastry blind.
	Fanned Grill	The fan allows the heat to circulate around the food. Ideal for thinner foods such as bacon, fish and gammon steaks. Foods do not require turning. Use with the oven door closed.
	Fanned Oven	The even temperature in the oven makes this function suitable for batch baking, or batch cooking foods.
	Defrost	To defrost foods, such as cream cakes/gateaux, use with the oven door closed. For cooling dishes prior to refrigeration, leave the door open.
	Dual Grill	This function cooks food from the top and is ideal for a range of food from toast to steaks. As the whole grill is working, you can cook larger quantities of food.
	Single Grill	For smaller quantities of food, but is still ideal for anything from toast to steaks.
	Base Heat with Fan	Used to cook open pies (such as mince pies) the base element ensures that the base is cooked while the fan allows the air to circulate around the filling - without being too intensive.
	Lights only	Use when the oven is switched off and cold to aid cleaning the oven cavity.

# Fanned Oven Guide

---

- Some adjustment will have to be made to conventional cooking temperatures.
- The table below shows conventional cooking temperatures, fanned temperatures and gas marks.  
For optimum results using the fanned oven setting, conventional temperatures need to be converted to the fanned oven temperatures.
- For example an item which would cook at 180°C will now cook at the fanned oven temperature of 160°C.
- This is a high efficiency oven, you may notice an emission of steam when the door is opened.
- When cooking chilled or frozen foods, use the recommended cooking times and temperature on the packaging. **Always** make sure the food is piping hot throughout before serving.
- There are no zones of heat, and no flavour transfer when using a fanned oven - allowing you to cook a greater variety of foods together.
- If you are cooking on more than one shelf, you may need to slightly increase the cooking time.
- Always make sure that there is enough space between dishes, to allow food to rise, and to air to circulate.

Conventional temp (°C)	'A' Efficiency oven (°C)	Gas mark
100	100	1/4
110	110	1/4
130	120	1/2
140	130	1
150	140	2
160	150	3
180 - 190	160	4 - 5
200	170	6
220	180	7
230	190	8
250	200	9

# Cooking Guide

## Pre-heating

To get the best results from your oven, we recommend pre-heating for around 5 to 15 minutes before placing your dishes in. This is especially important for items which are chilled, frozen, batter based, yeast based or whisked sponges.



If you are using a fanned function, you should still pre-heat but for a shorter time.

The items in the cooking guide below are based on a pre-heated oven, but can be adjusted to take into account personal taste.

## Oven and bakeware

Always use high quality trays and tins for cooking. Poor quality tins and trays can warp in the oven producing uneven results.

Never use dishes which are cracked, damaged or not oven proof as heating may lead to shattering inside the oven.

Food Type	Temp. Setting °C			Time Approx.	Shelf Position
	Conv 	Fanned 	Intensive 		
<b>Cakes</b>					
Small cakes	190	160	-	15 - 25	7 & 13
Victoria sandwich	180	160	-	20 - 30	7
Semi rich fruit cake	150	125	-	2 1/2 - 3hrs	5
Christmas cake	150	125	-	2 1/2 - 3hrs	3
<b>Puddings</b>					
Bread & butter pudding	170	150	-	45 - 1hr	9
Fruit crumble	200	175	-	40 - 1hr	9
<b>Miscellaneous</b>					
Yorkshire pudding: large	220	200	200	40 - 45	11
small	220	200	200	15 - 20	12
Shortcrust pastry	200	180	180	depends on filling	top - middle

# Roasting Guide

---

- Roasting times depend on the weight, shape and texture of the meat and personal preference. In order to calculate the roasting time, weigh the meat or poultry, **including the stuffing**, and follow the times given below.

Meat joints (including chicken) should be roasted at 180 - 200°C Conventional/ 160 - 180°C Fanned for 20 - 30 mins per 450g/1lb, plus 20 minutes on shelf position 2.

- Frozen meat must be **thoroughly** thawed before cooking. For large joints, it is advisable to thaw overnight.
- Frozen poultry must be **thoroughly** thawed before cooking. The time required depends on the size of the bird - eg: a large turkey may take up to 48 hours to thaw.
- When cooking stuffed meat or poultry, calculate the cooking time from the **total** weight of the meat **plus** the stuffing.
- Cooking joints in foil, covered roasters, lidded casseroles, or roasting bags will help to reduce meat shrinkage, give a more moist result and may reduce fat splashing. However, a slightly longer cooking time will be required, **add** 5 - 10 minutes per 450g (1lb) to the calculated cooking time. When using roasting bags do not exceed the temperatures recommended by the manufacturer, and do not allow the roasting bag to touch the sides or top of the oven.
- Use of a trivet with the roasting tin will reduce fat splashing during open roasting, and will help to keep the oven interior clean.
- The use of a roasting tin larger than that supplied is not advised, as this may impair performance and lead to extended cooking times.

# Roasting Guide

---

## Roast turkey

- Roasting turkey perfectly involves cooking two different types of meat - the delicate light breast meat, which must not be allowed to dry out, and the darker leg meat, which takes longer to cook.
- The turkey must be roasted long enough for the legs to cook, so frequent basting is necessary. The breast meat can be covered once browned.

Turkey should be roasted at 180 - 200°C  
Conventional/ 160 - 180°C Fanned for 20 - 30 mins  
per 450g/1lb, plus 20 minutes.

- The turkey can be open roasted, breast side down, for half of the cook time, and then turned over for the remainder of the cooking time.
- If the turkey is stuffed, **add** 5 minutes per 1lb to the cooking time.
- If roasting turkey covered with foil, **add** 5 minutes per 1lb to the cooking time.
- To test if the turkey is cooked, push a fine skewer into the thickest part of the thigh. If the juices run clear, the turkey is cooked. If the juices are still pink, the turkey will need longer cooking. Always make sure that the turkey is cooked properly before serving.

## Turkey Roasting times.

Most Turkeys are measured by the kilogram. Timing should be calculated in either of these ways:

40 minutes per 1kg plus 10 minutes per 1/4 kg.

or

20 minutes per 1lb, plus 20 minutes.

The maximum size Turkey for this appliance is: 20lbs  
approximately 9kgs.

Please do not attempt to roast a Turkey larger than this, as the results cannot be guaranteed.

# General Baking Guide

## Trouble-shooting - Fruit Cakes

<b>PROBLEM</b>	<b>POSSIBLE CAUSE</b>
Fruit sinking to the bottom	Low oven temperature which may cause the cake to take longer to set, allowing the fruit to sink. Or, too much liquid, or raising agent. The fruit may not have been properly washed and dried.
Cake sinking / dipping in the centre	Too much raising agent in the mixture. Too hot, or too cool an oven. Or, not enough liquid or insufficient creaming.
Surface cracks	Too small a tin, or too much mixture in the tin. Too much raising agent in the mix, plus not enough liquid or insufficient creaming. The oven may be too hot.
Hard outer crust with a damp patch inside	Oven too hot, therefore the cake baked too quickly. Too much sugar, or insufficient liquid.
Burnt outside	Oven temperature too high. Oven too small for the size of cake. Insufficient protection around the tin. Cake baked on too high a shelf.
Texture with pronounced holes.	Too much raising agent. Flour unevenly mixed.
Texture too close and cake insufficiently risen.	Not enough raising agent. Not enough liquid. Too cool an oven. Insufficient creaming.
Cake crumbles when cut	Not enough liquid. Baked for too long. Not enough sugar. Too much baking agent.
Too dry	Over baking. Insufficient egg or liquid. Too much raising agent.

## Trouble-shooting - Sponge Cakes

Domed top	Insufficient creaming of mixture. Cake baked on too high a shelf position, or at too high a temperature. Paper liners can cause the outer edge not to rise and the centre to peak.
Hollowed / sunken top	Too much raising agent. Oven temperature too low, or incorrect shelf position. Cake removed from oven before it's cooked. Use of soft tub margarine.
Very pale, but cooked	Oven temperature too low. Baked too low in the oven
Overflowing tin	Tin too small for the amount of mixture

# Cleaning your Gas Hob

Sometimes when a hob is not working well, it is because it needs cleaning.

## Enamel parts

- Use a mild cream cleaner for example 'Cif'. Stubborn marks can be removed with a soap filled pad.

## Stainless steel surfaces

- Only use a clean cloth wrung out with warm, soapy water and dried off with a soft cloth. For stubborn marks use a specialist stainless steel cleaner.
- **Do not** use steam cleaners.
- Sharp implements and objects can mark the surface of stainless steel, however they do become less noticeable in time.

## Cast iron parts

- Ensure the parts have fully cooled and scrape off any stubborn marks, and bits of food with a plastic, or wooden cooking implement. Rinse in warm soapy water and dry with a tea towel.
- **Do not** clean in a dishwasher.
- If you notice any rusting on your griddle, or pansupports, simply clean in warm soapy water, then re-season.

## Burner caps and skirts

The slots in the burner skirts where the flames burn should be cleared of deposits.

- Clean with a nylon brush, rinse and then dry thoroughly. There may be brownish coloured markings on your burners, these are carbon deposits or fat stains and can be removed using a soap filled pad.
- **Do not** put burners in the dishwasher or soak them. Using dishwasher powders, washing up liquids and caustic pastes can damage the burners.
- Burner caps and heads must be repositioned correctly so that they sit squarely on to the hob as shown on the left.
- This is particularly important with stainless steel models as failure to reposition the caps correctly may result in discolouration of the stainless steel around the burners.

## Painted & Plastic parts

- Only use a clean cloth wrung out in hot soapy water.



**Always allow your appliance to cool down, and switch off the electricity before you clean any part of it.**



Baby oil can be used to restore stainless steel finishes - but only use a few drops. Don't use cooking oils as they can contain salts which will damage the metal.



Don't use: undiluted bleaches, products containing chlorides, wire wool or abrasive cleaners on aluminium, stainless steel, or plastic/painted parts they can damage the appliance. Nylon pads can also be unsuitable



## Seasoning the griddle:

Pour a drop of unsalted cooking oil onto the cooking side of the griddle, use kitchen roll to cover the griddle evenly. Olive oil is not suitable for seasoning. Regular seasoning prevents rust.

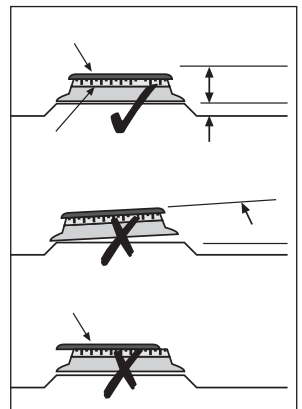



# Cleaning your Cavities

## Cleaning the oven cavities

- Some foods can cause fat to spit, especially if you have open roasted, this leaves the inside of the cavity greasy.
- It is important to clean the oven cavity as a build up of fat can damage the appliance and may invalidate your guarantee.

## Chrome plated parts.

- Use a moist soap filled pad, or place in a dishwasher.
- Shelf runners can be removed to enable you to clean then thoroughly. Make sure they are cool to touch and then grasp the runners and slide out of their hanging holes.

## Pristine enamel surfaces

- The enamel can be cleaned by wiping the surfaces with a clean cloth which has been wrung out in hot, soapy water.
- If larger splashes of fat do not readily disappear, you can use a mild cream cleaner to remove them. More stubborn marks can be removed using a soap filled pad.
- Rinse well, and allow to dry before use.

## Vitreous enamel surfaces

- The enamel can be cleaned by wiping the surfaces with a clean cloth which has been wrung out in hot, soapy water.
- Stubborn marks can be cleaned using a moistened soap filled pad, or a mild cream cleaner.
- Rinse well, and allow to dry before use.



**Always allow your appliance to cool down, and switch off the electricity before you clean any part of it.**

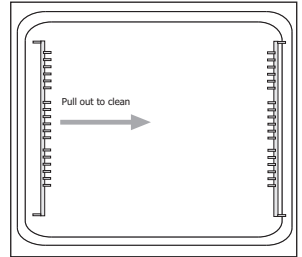

**Don't use:**  
Caustic or abrasive cleaners, bleaches, coarse wire wool or hard implements, these will damage your appliance.



Using a trivet while roasting meat may help to reduce fat splashes.

# Cleaning your Appliance

## Painted & Plastic parts

- Only use a clean cloth wrung out in hot soapy water.
- **Do not** use abrasive cleaners, such as "Cif", wire or nylon cleaning pads on these parts.

## Stainless steel & Aluminium surfaces

- Only use a clean cloth wrung out in hot soapy water, and dry with a soft cloth.
- Stubborn marks can be removed using a stainless steel cleaner. Supplies can be purchased from the Customer Care Centre.
- Sharp objects can mark the surface of stainless steel, but will become less noticeable with time.
- Wipe any spillage immediately, taking care to avoid burning your hands.
- Some foods are corrosive eg; vinegar, fruit juices and especially salt - they can mark or damage the metal if they are left on the surface.

## Enamel surfaces & parts

- Clean with warm, soapy water and a clean cloth.
- Dry with a soft clean towel or cloth.
- Do not use steam cleaners.

## Glass parts

- Only use a clean cloth wrung out in hot soapy water, or a specialist glass cleaner.
- Rinse away any excess cleaner and dry with a soft cloth.
- Do not use abrasives or polishes as they will scratch and damage the glass.
- The inner door glass panel can be removed for cleaning but it must be replaced the right way up. If there is any writing on the glass, you must be able to read it clearly when the cavity doors are open.
- Always make sure that the glass is pushed fully into the **Stop** position.
- To remove the glass panel, open the door wide, hold the top and bottom edges and slide out.
- Warning: Do not operate the appliance without the glass panel correctly fitted.



**Always allow your appliance to cool down, and switch off the electricity before you clean any part of it.**



Take extra care when cleaning over symbols on fascia panels, excessive cleaning can lead to the symbols fading.



Baby oil can be used to restore stainless steel finishes - but only use a few drops. Don't use cooking oils as they can contain salts which will damage the metal.



Don't use: undiluted bleaches, products containing chlorides or abrasive cleaners on aluminium or stainless steel, they can damage the appliance.

## Glass door panels

For your safety, glass door panels are made of toughened glass. This ensures that, in the unlikely event that a panel breaks, it does so into small fragments to minimise the risk of injury.

Please take care when handling, using or cleaning all glass panels, as any damage to the surfaces or edges may result in the glass breaking without warning or apparent cause at a later date.

Should any glass panel be damaged, we strongly recommend that it is replaced immediately.

# Cook Shop

To order or enquire about any of these products, please call the Spares Sales team on: **0844 815 3745**

<b>Product description</b>	<b>Product code</b>	<b>Quantity</b>	<b>Where used</b>
Rectangular carbon filters	082612620	2	Hoods
Round carbon filters	082611571	1	Hoods
Ceramic hob scraper kit	082606781	1	All ceramic glass hobs including induction.
Ceramic hob cleaner and conditioner	082606780	1	All ceramic glass hobs including induction
Sealed hotplate conditioner	082606783	1	All sealed / solid plate hobs.
Stainless steel cleaner	082606764	1	All stainless steel parts
Oven cleaner spray	082606786	1	All cookers, inside cavities and on glass.
Multi-purpose kitchen cleaner	082606782	1	General kitchen cleaner.
E-cloth	082813300	1	All cookers, for cleaning glass and stainless steel

# Before you call. .

<b>Problem?</b>	<b>Advice</b>
<b>The ignition won't work.</b> (Gas and dual fuel models)	<ul style="list-style-type: none"><li>● Check there is a spark when the ignition button is depressed. If there is no spark, check the electricity supply is switched on at the socket.</li><li>● Check that the gas supply is switched on.</li></ul>
<b>There's condensation on the doors.</b>	<p>Condensation is caused by hot, moist air meeting a cooler surface (i.e. the oven door). You cannot always prevent it, but you can minimise it when it happens by doing the following:</p> <ul style="list-style-type: none"><li>● Pre-heat the oven at a high temperature before putting food in the oven, and cover the food you are cooking wherever possible.</li><li>● Whenever you can, cook wet foods at higher temperatures.</li><li>● Don't leave food in the oven to cool down.</li></ul> <p>Automatic cooking will normally produce condensation when the oven is cooling down with food inside.</p>
<b>There's been a power failure and the oven won't work.</b> (models with clocks and automatic programmers)	<ul style="list-style-type: none"><li>● Switch off the electricity supply.</li><li>● When the power returns - re-set the programmer/Clock to the correct time of day.</li></ul> <p>This will allow you to use your appliance.</p>

# Changing Light Bulbs

---

**Warning:** There is a risk of electric shock, so always make sure you have turned off and unplugged your appliance.

Not all appliances have the same number and type of bulbs. Before replacing your bulb, open the top/main oven door and see which type you have. Then use the table to help you change your bulb correctly.

**Please remember that bulbs are not covered by your warranty.**

Bulbs can be purchased from hardware stores (always take the old bulb with you).

No. of lamps	Bulb Location	Oven type	Instruction for changing the bulb
2 (@25W)	side	All	Wait until the oven is cool, then remove the oven shelves. Grasp the lens cover on the light fitting and pull it away from the side of the oven. Unscrew the bulb.
1 (@25W)	rear	Fanned / Multifunction	Wait until the oven is cool, then remove the shelves. The oven light is at the rear of the oven cavity. Remove the loose oven back - unscrew the 4 securing screws (one at each corner). Unscrew the lens cover (turn anticlockwise). Unscrew the bulb and replace. Replace lens cover and replace oven back.
1 (@25W)	rear	Conventional	Wait until the oven is cool, then remove the oven shelves. The oven light is at the rear of the oven cavity. Unscrew the lens cover (turn anticlockwise). Unscrew the bulb and replace. Replace lens cover.

There is no need to remove the oven back on the 90DF model.

# Installing Your Cooker

## Clearances

This cooker may be fitted flush to the base units of your kitchen.

- No shelf, overhang, cupboard, or cooker hood should be less than 650mm above the hob top, but please check this with the hood manufacturers instructions.
- If your appliance has a side opening door, we recommend a side clearance of 60mm to allow the oven door to fully open.
- The cooker must have a side clearance above hob level of 90mm up to a height of 400mm.
- The important dimensions are those around the appliance.

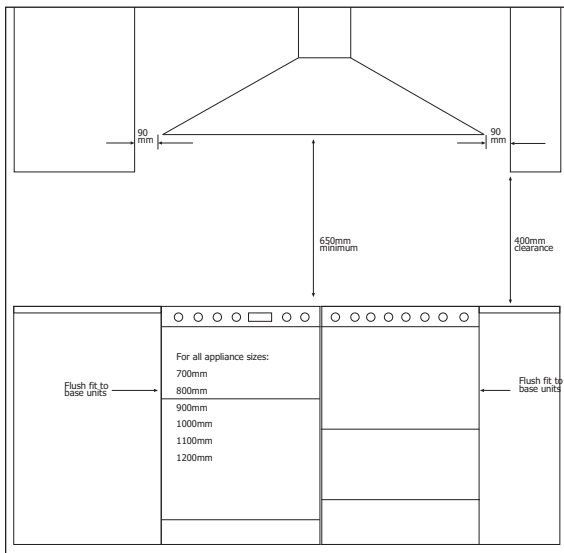

# Installing Your Cooker

---

The information below is crucial to installing this appliance correctly and safely.

## **Ventilation Requirements**

The room containing the appliance should have an air supply in accordance with BS 5440:Part 2.

- All rooms require an openable window, or equivalent, and some will require a permanent vent as well.
- For room volumes up to  $5\text{m}^3$  an air vent of  $100\text{cm}^3$  is required.
- If the room has a door which opens directly to the outside, or exceeds  $10\text{m}^3$  - no air vent is required.
- For room volumes between  $5\text{m}^3$  and  $10\text{m}^3$  and air vent of  $50\text{cm}^2$  is required.
- If there are other fuel burning appliances in the same room, BS 5440:Part 2 should be consulted to determine the air vent requirements.
- This appliance must not be fitted into a bed sitting room of less than  $20\text{m}^3$  or into a bath or shower room.

Windows and vents should not be blocked or removed without first consulting a competent engineer.

**LPG only** - do not install this appliance below ground level. This does not preclude installation into rooms which are basements with respect to one side of the building, but open to ground level on the opposite side.

Where standards have been revised - always use the most recent edition.

**Failure to install appliances correctly is dangerous and could lead to prosecution.**

# Installing Your Cooker

---

The information below is crucial to installing this appliance correctly and safely.

## **UK Regulations & Standards**

always refer to the most recent issue of the standards

- Gas Safety Regulations.
- Building Regulations - issued by the DEFRA.
- Building Standards (Scotland) (Consolidated) - issued by the Scottish Development Department.
- I.E.E. Wiring Regulations.
- Electricity at Work Regulations.
- BS 6172 Installation of Domestic Gas Cooking. For **LP Gas**, refer to BS 5482 Part 1, Part 2 or Part 3 as relevant.
- Installation and Servicing Instructions for this appliance.

For installation in countries other than the UK, the appliance must be connected in accordance with all local gas and electrical regulations.

In the Republic of Ireland installers should refer to IS 813 Domestic Gas Appliances.

**Failure to install appliances correctly is dangerous and could lead to prosecution.**



# Installing Your Cooker

## Fitting the plinth (if applicable)

- Make sure the appliance is raised to a height of 915mm or above before beginning. If the appliance is below 915mm - you can only fit the plinth cover labelled X. You can adjust the height using the feet (1) of the appliance.  
If your appliance has a storage drawer at the bottom, you access the required holes through the base of the drawer after lifting the mat.
- Open the appliance doors, and loosen screw A located on bracket (2). Do not remove this screw entirely.
- Insert screw B, through slot (3) and screw into the small hole at the bottom of bracket (2).  
Make sure that the plinth cover is flush to the appliance, but not over tightened.

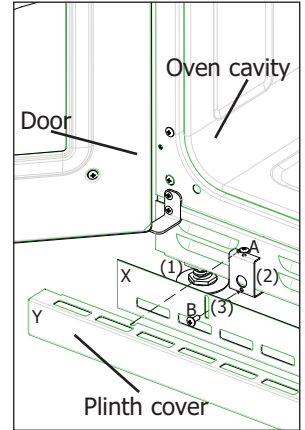

## Fitting the splashback (if applicable)

- Remove the screws from the rear of the hotplate vent.
- Locate the splashback in position so that all the fixing holes are in line with the holes in the rear of the hotplate vent.
- Re-fit screws into the holes to secure the splashback in place.

# Installing Your Cooker

## Stabilising and Securing

Your cooker may come with a stability chain, if it does not we recommend that you buy a stability bracket from your local supplier, this will keep the cooker from moving and will prevent damage to the flexible hosing at the back of the cooker.

### Your stability chain

Your cooker must be secured to a wall or a solid partition behind the cooker.

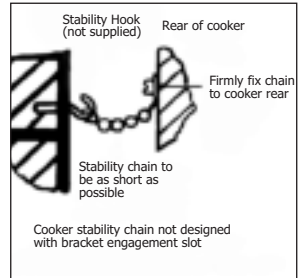

### Your stability bracket

You can buy a stability bracket from your supplier and it can fitted as follows:

- Place the cooker in position and draw a pencil line level with the front edge.
- Remove the cooker and mark off 450mm from the pencil line to locate the front edge of the lower bracket.
- Fix the bracket to the floor. Measure from floor level to engagement edge in the back of the cooker and add 3mm.
- Assemble the underside of the top part of the bracket to this height.
- See the drawings for the location of the bracket and the recommended positioning.

## Levelling

Once your cooker is secure:

Place a spirit level onto a baking tray, on an oven shelf. These cookers are fitted with adjustable feet which will allow you to adjust the height of the appliance until it is level. The adjustable feet are at the rear of the cooker.

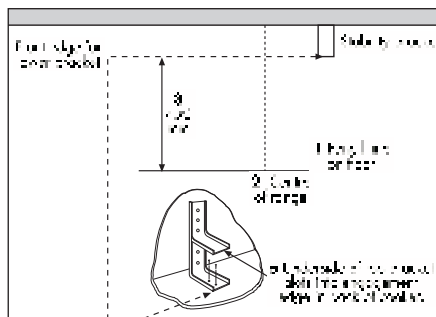
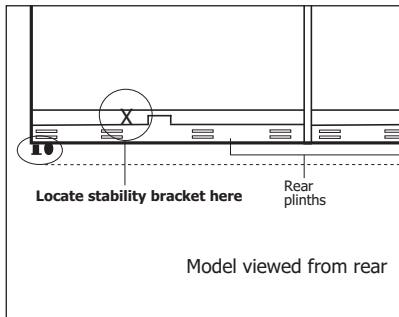

# Installing Your Cooker

---

## Connecting the electricity supply

### **Warning: This appliance must be earthed!**

- This appliance must be fitted using a double pole unit of 30 ampere minimum capacity with 3mm minimum contact at all poles.
- Access to the mains terminal is gained by opening the terminal block cover at the rear of the appliance - use a flat bladed screw driver for this.
- Connection should be made with a 6.0mm<sup>2</sup> twin and earth cable.
- First strip the wires. Then push the cable through the cable clamping the terminal block cover.
- Connect the cable to the terminal block and tighten the cable clamp screw - see diagram.
- Close the terminal box, ensuring that the cover is engaged on the locking tabs.
- Sufficient cable should be used to allow the cooker to be pulled out, but must hang clear of the floor so it does not become twisted or trapped when the cooker is pushed back.

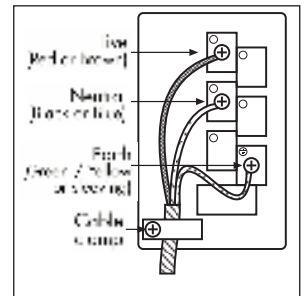

Please ensure that the user has this copy of the handbook, and the appliance is in place. Thank you.

# Installing Your Cooker

---

## **Connecting to the gas supply**

The inlet to the appliance is ISO 7 - Rp  $\frac{1}{2}$ " internal thread situated towards the top right corner of the rear.

Fit the bayonet connection. This should be located so as to ensure that the flexible hose does not kink.

Use a 900mm - 1125mm length of flexible hose.

Ensure that all pipe work is of the correct rating.

**Natural Gas** - Flexible connections should comply with BS 669. Parts of the appliance likely to come into contact with a flexible connector have a temperature of less than 70 °C.

**LP Gas** - For flexible connections use a bayonet type hose, suitable for use on LP Gas up to 50mbar pressure rise and 70 °C temperature rise. The flexible hose should be coloured black with a red stripe, band or label. If in doubt, contact your supplier.

**After installation make sure all connections are gas sound.**

## **Commissioning**

### **Pressure settings:**

G20 Natural Gas @ 20mbar

G30 Butane @ 28-30mbar / 50mbar

G25 Natural Gas @ 20mbar

G31 Propane @ 37mbar

### **Hob**

Turn on gas supply and check for soundness at the hot-plate injector. Light two burners and check that the pressure is correct.

### **Grill**

Turn the control knob to the full on position and ignite, allow the grill to operate for a few minutes.

### **Oven**

Turn the control knob to the full on position and ignite, allow the oven to operate for a few minutes.

# Technical Data - Notes

---

## **Type of gas:**

Natural Gas I<sub>2H</sub>

Natural Gas II<sub>2H3+\*</sub>

Natural Gas II<sub>2ELL3B/P\*</sub>

LP Gas I<sub>3+</sub>

Please see your data badge for specified gas type.

\* Can be converted from Natural gas to LP Gas



Never attempt to convert an appliance - unless the data badge states that you can.

## **Burner Aeration:**

Fixed

## **Pressure setting:**

G20 Natural Gas @ 20mbar

G30 Butane @ 28-30mbar / 50mbar

G25 Natural Gas @ 20mbar

G31 Propane @ 37mbar

## **Electrical supply:**

220 - 240V ~ 50Hz

## **Countries of destination:**

**GB**

**IE**

**DE**

# Technical Data - Notes

Fuel Type	Hotplate Burner / Element	Nominal Rate Qn	Butane g/h	Propane g/h	Injectors used
Natural Gas G20 & G25	Hob - small	1.0kW	-	-	77
	Hob - medium	2.0kW	-	-	104
	Hob - Large	3.0kW	-	-	129
	Hob - wok	3.5kW	-	-	121 & 63
	Total heat input				
	●5 burners	11.5kW			
	●7 burners	14.5kW			
LP Gas	Hob - small	1.0kW	73	72	50
	Hob - medium	2.0kW	145	143	70
	Hob - Large	3.0kW	218	215	87
	Hob - wok	3.5kW	254	250	87 & 35
	Total heat input				
	●5 burners	11.5kW			
	●7 burners	14.5kW			

Fuel Type	Conventional oven	Fanned oven	Dual variable grill (90/100 size)	Dual variable grill (110 size)
Electric @ 230V	2.1kW	2.0kW	1.8 - 2.7kW	1.8 - 2.8kW
		2.5kW (900 tall oven)		
	<b>Oven lamps</b>			
	25W each			
<b>Appliance size</b>				
<b>90DFT</b>	<b>100DFT</b>	<b>110DFT</b>	<b>90DFT DB4</b>	
220 - 240V 6150 - 7320W	220 - 240V 5775 - 6870W	220 - 240V 5860 - 6970W	6150 - 7320W	



# Contact Us

---

Should you need to get in touch with us (UK and Northern Ireland only), please call Belling Customer Care Centre Helpline on:

**0844 815 3746**

For customers outside the UK and Northern Ireland, please contact your local supplier.



Glen Dimplex Home Appliances Limited is the owner of the Belling brand and is part of the Glen Dimplex group of companies.  
Stoney Lane, Prescot, Merseyside, L35 2XW

**08 27505 02 © 11.2010**

**Dual Fuel Range**

**Model Names: Belling classic 90DFT, 100DFT & 110DFT. Belling DB4 90DF**