

USER MANUAL

ProLite

LCD Monitor

ENGLISH

ProLite XUB2294HSU
ProLite XUB2294HS
ProLite XU2294HSU
ProLite XU2294HS
ProLite XUB2292HS
ProLite XU2292HS

Thank you very much for choosing the iiyama LCD monitor.

We recommend that you take a few minutes to read this comprehensive manual carefully before installing and switching on the monitor. Please keep this manual in a safe place for your future reference.



Dear user, we congratulate you on the purchase of your iiyama LCD.

For details on warranty and locally used pixel policies that apply directly after installation of your product please check the iiyama website.

To report a fault, please contact your local support centre found at www.iiyama.com/service

Things to check before you call the iiyama information line

- | if the power cable is connected securely and turned on?
- | if the display has been turned on?
- | if the signal cable is connected securely and the correct input selected?
- | if the computer has been restarted with the display connected?
- | if the graphics card is correctly installed with the latest drivers possible?
- | if the correct native resolution has been selected via 'Display Properties'?
- | If the R/G/B signal configuration is correct?
- | if the displays On Screen Menu is shown?
- | if the correct brightness and contrast settings have been set?
- | if given display tolerances and compatibility have been considered?
- | if via the On Screen Menu you have performed a Factory Reset/Recall?

Before reporting the screen defect, please prepare the following information/evidence:

- | model number *
- | purchase receipt and serial number *
- | name and address for collection
- | telephone/fax number, for availability during the day
- | convenient collection date (date, time)
- | short description of the defect

Important Note:

If there is no fault found in the collected equipment after inspection, the transferring party shall incur charges for transport and administration.

If you have checked all of the above and there is still no picture, call our information line for assistance in your country.

* see the identification plate on the back of the case.

CE MARKING DECLARATION OF CONFORMITY

This LCD monitor complies with the requirements of the EC/EU Directive 2014/30/EU "EMC Directive", 2014/35/EU "Low Voltage Directive", 2009/125/EC "ErP Directive" and 2011/65/EU "RoHS Directive".

The electro-magnetic susceptibility has been chosen at a level that gives correct operation in residential areas, business and light industrial premises and small-scale enterprises, inside as well as outside of the buildings. All places of operation are characterised by their connection to the public low voltage power supply system.

IYAMA CORPORATION: Wijkmeesterstraat 8, 2131 HA Hoofddorp, The Netherlands

Model No. : PL2294H / PL2292H



We recommend recycling of used product. Please contact your dealer or iiyama service center. Recycle information is obtained via the Internet, using the address: <http://www.iiyama.com>

You can access the Web page of different countries from there.

- We reserve the right to change specifications without notice.
- All trademarks used in this user manual are the property of their respective owners.

TABLE OF CONTENTS

FOR YOUR SAFETY.....	1
SAFETY PRECAUTIONS.....	1
SPECIAL NOTES ON LCD MONITORS.....	3
CUSTOMER SERVICE.....	3
CLEANING.....	3
BEFORE YOU OPERATE THE MONITOR.....	4
FEATURES.....	4
CHECKING THE CONTENTS OF THE PACKAGE.....	4
INSTALLATION.....	5
FITTING AND REMOVAL OF BASE :	
ProLite XUB2294HSU / ProLite XUB2294HS / ProLite XUB2292HS.....	7
FITTING AND REMOVAL OF BASE :	
ProLite XU2294HSU / ProLite XU2294HS / ProLite XU2292HS.....	8
CONTROLS AND CONNECTORS :	
ProLite XUB2294HSU / ProLite XUB2294HS / ProLite XUB2292HS.....	9
CONTROLS AND CONNECTORS :	
ProLite XU2294HSU / ProLite XU2294HS / ProLite XU2292HS.....	10
CONNECTING YOUR MONITOR : ProLite XUB2294HSU.....	11
CONNECTING YOUR MONITOR : ProLite XUB2294HS / ProLite XUB2294HS... ..	12
CONNECTING YOUR MONITOR : ProLite XU2294HSU.....	13
CONNECTING YOUR MONITOR : ProLite XU2294HS / ProLite XU2292HS ..	14
COMPUTER SETTING.....	15
ADJUSTING THE HEIGHT AND THE VIEWING ANGLE :	
ProLite XUB2294HSU / ProLite XUB2294HS / ProLite XUB2292HS.....	15
ADJUSTING THE VIEWING ANGLE :	
ProLite XU2294HSU / ProLite XU2294HS / ProLite XU2292HS.....	16
OPERATING THE MONITOR.....	17
ADJUSTMENT MENU CONTENTS.....	18
SCREEN ADJUSTMENTS.....	28
POWER MANAGEMENT FEATURE.....	31
TROUBLE SHOOTING.....	32
RECYCLING INFORMATION.....	33
APPENDIX.....	34
SPECIFICATIONS : ProLite XUB2294HSU.....	34
SPECIFICATIONS : ProLite XUB2294HS.....	35
SPECIFICATIONS : ProLite XUB2292HS.....	36
SPECIFICATIONS : ProLite XU2294HSU.....	37
SPECIFICATIONS : ProLite XU2294HS.....	38
SPECIFICATIONS : ProLite XU2292HS.....	39
DIMENSIONS :	
ProLite XUB2294HSU / ProLite XUB2294HS / ProLite XUB2292HS.....	40
DIMENSIONS : ProLite XU2294HSU / ProLite XU2294HS / ProLite XU2292HS ..	40
COMPLIANT TIMING.....	41

FOR YOUR SAFETY

SAFETY PRECAUTIONS

WARNING

STOP OPERATING THE MONITOR WHEN YOU SENSE TROUBLE

If you notice any abnormal phenomena such as smoke, strange sounds or fumes, unplug the monitor and contact your dealer or iiyama service center immediately. Further use may be dangerous and can cause fire or electric shock.

NEVER REMOVE THE CABINET

High voltage circuits are inside the monitor. Removing the cabinet may expose you to the danger of fire or electric shock.

DO NOT PUT ANY OBJECT INTO THE MONITOR

Do not put any solid objects or liquids such as water into the monitor. In case of an accident, unplug your monitor immediately and contact your dealer or iiyama service center. Using the monitor with any object inside may cause fire, electric shock or damage.

INSTALL THE MONITOR ON A FLAT, STABLE SURFACE

The monitor may cause an injury if it falls or is dropped.

DO NOT USE THE MONITOR NEAR WATER

Do not use where water may be splashed or spilt onto the monitor as it may cause fire or electric shock.

OPERATE UNDER THE SPECIFIED POWER SUPPLY

Be sure to operate the monitor only with the specified power supply. Use of an incorrect voltage will cause malfunction and may cause fire or electric shock.

PROTECT THE CABLES

Do not pull or bend the power cable and signal cable. Do not place the monitor or any other heavy objects on the cables. If damaged, the cables may cause fire or electric shock.

ADVERSE WEATHER CONDITIONS

It is advisable not to operate the monitor during a heavy thunder storm as the continual breaks in power may cause malfunction. It is also advised not to touch the plug in these circumstances as it may cause electric shock.

CAUTION

INSTALLATION LOCATION

Do not install the monitor where sudden temperature changes may occur, or in humid, dusty or smoky areas as it may cause fire, electric shock or damage. You should also avoid areas where the sun shines directly on the monitor.

DO NOT PLACE THE MONITOR IN A HAZARDOUS POSITION

The monitor may topple and cause injury if not suitably located. Please also ensure that you do not place any heavy objects on the monitor, and that all cables are routed such that children may not pull the cables and possibly cause injury.

MAINTAIN GOOD VENTILATION

Ventilation slots are provided to keep the monitor from overheating. Covering the slots may cause fire. To allow adequate air circulation, place the monitor at least 10cm (or 4 inches) from any walls. When removing the tilt stand, the ventilation slots on the back side of the monitor can be blocked. This may overheat the monitor and may cause fire or damage. Make sure to allow enough ventilation when removing the tilt stand. Operating the monitor on its back, side, upside down or on a carpet or any other soft material may also cause damage.

DISCONNECT THE CABLES WHEN YOU MOVE THE MONITOR

When you move the monitor, turn off the power switch, unplug the monitor and be sure the signal cable is disconnected. If you do not disconnect them, it may cause fire or electric shock.

UNPLUG THE MONITOR

If the monitor is not in use for a long period of time it is recommended that it is left unplugged to avoid accidents.

HOLD THE PLUG WHEN DISCONNECTING

To disconnect the power cable or signal cable, always pull it by the plug. Never pull on the cable itself as this may cause fire or electric shock.

DO NOT TOUCH THE PLUG WITH WET HANDS

Pulling or inserting the plug with wet hands may cause electric shock.

WHEN YOU INSTALL THE MONITOR ON YOUR COMPUTER

Be sure the computer is strong enough to hold the weight of the monitor, otherwise, you may damage your computer.

CAREFUL! PROTECT YOUR HANDS AND FINGERS

- Be careful not to hurt your fingers or hands when you change the height or the angle.
- Injury can occur if care is not taken to avoid finger contact with the displays base when adjusting the height. (Just for height adjustable model.)

REMARK FOR 24/7 USAGE

This product is not specifically designed for 24/7 usage in all environments.

OTHERS

ERGONOMIC RECOMMENDATIONS

To eliminate eye fatigue, do not operate the monitor against a bright background or in a dark room. For optimal viewing comfort, the monitor should be just below eye level and 40-60 cm (16-24 inches) away from your eyes. When using the monitor over a prolonged time, a ten minute break every hour is recommended as looking at the screen continuously can cause eye strain.

SPECIAL NOTES ON LCD MONITORS

The following symptoms are normal with LCD monitors and do not indicate a problem.

NOTE

- When you first turn on the LCD monitor, the picture may not fit in the display area because of the type of computer that is used. In this case, adjust the picture position to the correct position.
- You may find slightly uneven brightness on the screen depending on the desktop pattern you use.
- Due to the nature of the LCD screen, an afterimage of the previous screen may remain after switching the image, when the same image is displayed for hours. In this case, the screen can be recovered slowly by changing the image or turning off the Power Switch for some hours.

CUSTOMER SERVICE

NOTE

- If you have to return your unit for service and the original packaging has been discarded, please contact your dealer or iiyama service center for advice or replacement packaging.

CLEANING

WARNING

- If you drop any materials or liquids such as water into the monitor when cleaning, unplug the power cable immediately and contact your dealer or iiyama service center.

CAUTION

- For safety reasons, turn off the power switch and unplug the monitor before you clean it.

NOTE

- To protect the LCD panel, do not scratch or rub the screen with a hard object.
- Never use any of the following strong solvents. These will damage the cabinet and the LCD screen.

Thinner	Spray-type cleaner
Benzine	Wax
Abrasive cleaner	Acid or Alkaline solvent

- Touching the cabinet with any product made from rubber or plastic for a long time may cause degeneration or loss of paint on the cabinet.

CABINET

Stains can be removed with a cloth lightly moistened with a mild detergent solvent. Then wipe the cabinet with a soft dry cloth.

LCD

Periodic cleaning with a soft dry cloth is recommended.

SCREEN

Don't use tissue paper etc. because these will damage the LCD screen.

BEFORE YOU OPERATE THE MONITOR

FEATURES

- ◆ Supports Resolutions up to 1920 × 1080
- ◆ High Contrast 3000:1 (Typical), Adv. Contrast Function Available / Brightness 250cd/m² (Typical) : ProLite XUB2294HSU / ProLite XU2294HSU / ProLite XUB2294HS / ProLite XU2294HS
- ◆ High Contrast 1000:1 (Typical), Adv. Contrast Function Available / Brightness 250cd/m² (Typical) : ProLite XUB2292HS / ProLite XU2292HS
- ◆ Quick Response Time 4ms (Gray to Gray)
- ◆ Blue Light Reducer
- ◆ Digital Character Smoothing
- ◆ Automatic Set-up
- ◆ Stereo Speakers
2 × 1W Stereo Speakers
- ◆ Plug & Play VESA DDC2B Compliant
Windows[®] 7/8.1/10 Compliant
- ◆ Power Management (VESA DPMS Compliant)
- ◆ VESA Mounting Standard (100mm×100mm) Compliant
- ◆ Keyhole for Security Lock

CHECKING THE CONTENTS OF THE PACKAGE

The following accessories are included in your package. Check to see if they are enclosed with the monitor. If anything is missing or damaged, please contact your local iiyama dealer or regional iiyama office.

- | | | |
|--------------------------------|------------------------------|---|
| ■ Power Cable* ¹ | ■ HDMI Cable | ■ USB Cable* ^{2,5} |
| ■ Stand-Base* ^{3,5} | ■ Stand-Neck* ^{3,5} | ■ Stand-Base with a screw* ^{2,4} |
| ■ Cable Holder* ^{3,5} | ■ Safety Guide | ■ Quick Start Guide |

CAUTION

*¹ The rating of the Power Cable enclosed in 120V area is 10A/125V. If you are using a power supply higher than this rating, then a power cable with a rating of 10A/250V must be used. However, all guarantees and warranties are void for any problems or damage caused by a power cable not supplied by iiyama.
An approved power cord greater or equal to H05VVF, 3G, 0.75mm² must be used.

*² Accessory for ProLite XUB2294HSU.

*³ Accessory for ProLite XU2294HS / ProLite XU2292HS.

*⁴ Accessory for ProLite XUB2294HS / ProLite XUB2292HS.

*⁵ Accessory for ProLite XU2294HSU.

INSTALLATION

- WARNING** ■ Before installation, make sure the wall, ceiling or desktop arm is strong enough to hold the necessary weight of the display and the mount.

< WALL MOUNTING >

- WARNING** ■ When you use with the wall mounting, in consideration of thickness of the mounting stage, tighten the M4 Screw with washer which "L" length is 7mm to fasten the monitor. Using the screw longer than this may cause electric shock or damage because it may contact with the electrical parts inside the monitor.

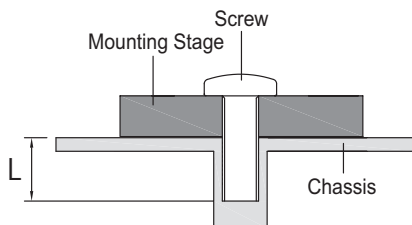

< ROTATING THE DISPLAY >

● ProLite XUB2294HSU / ProLite XUB2294HS / ProLite XUB2292HS

The monitor is designed to be compatible with both landscape and portrait modes.

Video card for portrait display will be required for rotating the image on the screen.

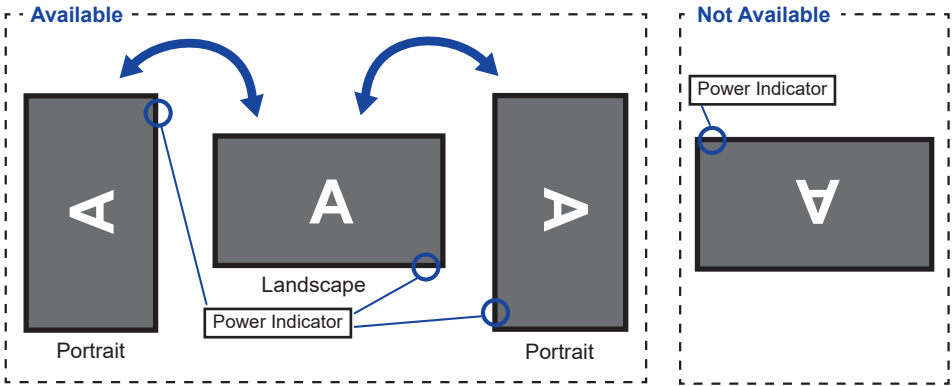

With Stand:

NOTE

- Adjust the monitor's height before panel rotation.
- Attempting to rotate the panel forcibly without adjusting the stand height may cause damage to the panel or the stand.

● ProLite XU2294HSU / ProLite XU2294HS / ProLite XU2292HS

It is designed to be compatible in landscape mode.

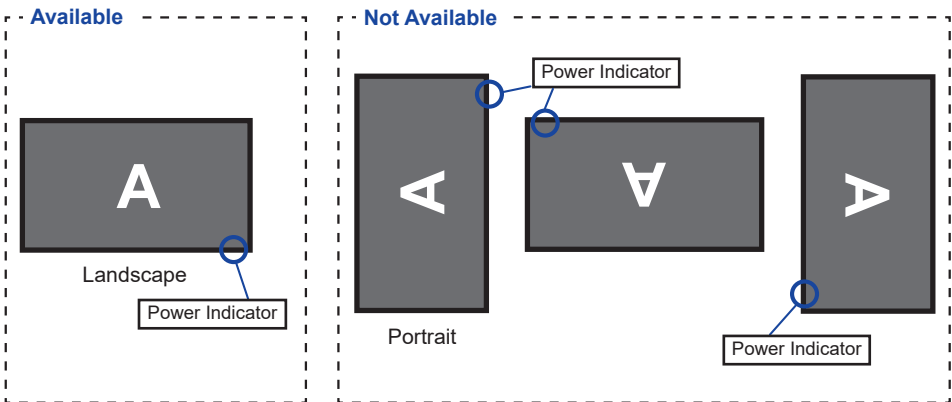

FITTING AND REMOVAL OF BASE :

ProLite XUB2294HSU / ProLite XUB2294HS / ProLite XUB2292HS

CAUTION

- Put the monitor on a stable surface. The monitor may cause injury or damage if it falls or is dropped.
- Do not give a strong impact to the monitor. It may cause damage.
- Unplug the monitor before removal or installation to avoid an electric shock or a damage.

<Installation>

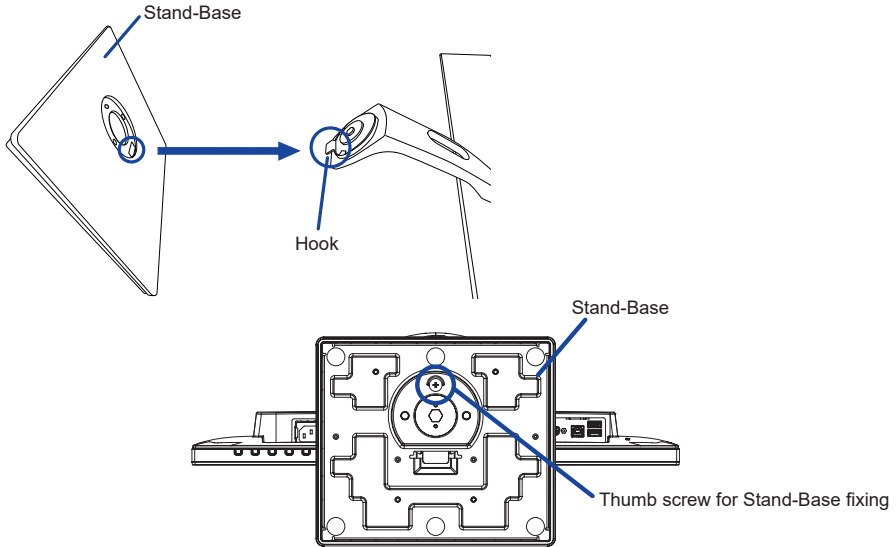

- ① Put a piece of soft cloth on the table beforehand to prevent the monitor from being scratched. Lay the monitor flat on a table with front face down.
- ② Install the stand-base as shown on above picture.
- ③ Use the 'thumb screw' provided to secure the base to the monitor.

<Removal>

- ① Put a piece of soft cloth on the table beforehand to prevent the monitor from being scratched. Lay the monitor flat on a table with front face down.
- ② Loosen the 'thumb screw' to remove the Stand-Base from the monitor.

FITTING AND REMOVAL OF BASE :

ProLite XU2294HSU / ProLite XU2294HS / ProLite XU2292HS

- CAUTION**
- Put the monitor on a stable surface. The monitor may cause injury or damage if it falls or is dropped.
 - Do not give a strong impact to the monitor. It may cause damage.
 - Unplug the monitor before removal or installation to avoid an electric shock or a damage.

<Installation>

- ① Put a piece of soft cloth on the table beforehand to prevent the monitor from being scratched. Lay the monitor flat on a table with front face down.
- ② Hold the monitor and install the Stand-Neck to the monitor until it clicks and is secure.
- ③ Hold the monitor and install the Stand-Base to the stand-neck until it clicks and is secure.
- ④ Place the Cable Holder.*

NOTE

* The cable holder cannot be removed after installation.

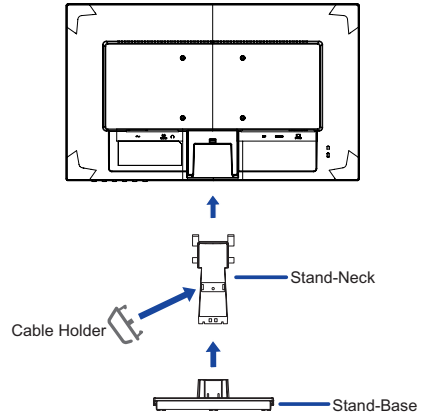

<Removal>

- ① Put a piece of soft cloth on the table beforehand to prevent the monitor from being scratched. Lay the monitor flat on a table with front face down.
- ② Keep pressing the hooks inward to pull out the Stand-Base.
- ③ Press the hook on the back of the monitor and remove the Stand-Neck from the monitor.

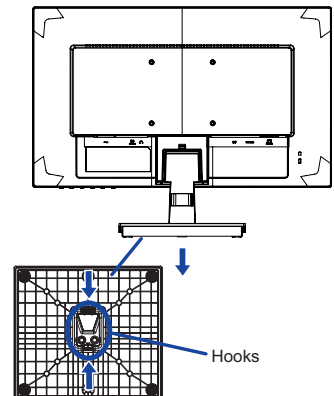
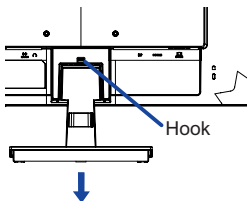

CONTROLS AND CONNECTORS :

ProLite XUB2294HSU / ProLite XUB2294HS / ProLite XUB2292HS

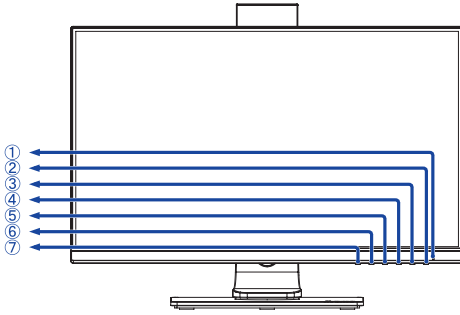

<Front>

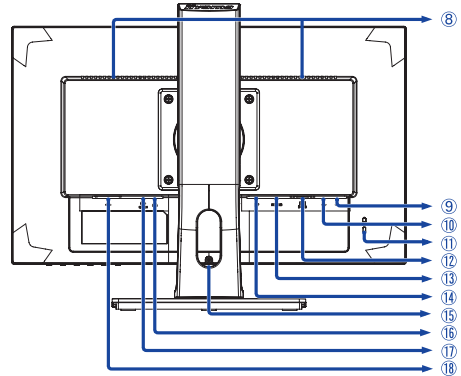

<Back>

- ① Power Indicator

NOTE Blue: Normal operation
Orange: Power Management

- ② Power Switch (⏻)
- ③ Menu / Select Button (MENU)
- ④ Scroll Up / Volume Button (▶ / 🔊)
- ⑤ Scroll Down / ECO Mode Button (◀ / 🍃)
- ⑥ Exit Button (EXIT)
- ⑦ Input Select Button (INPUT)
- ⑧ Speakers
- ⑨ USB Downstream Connector (🔌) *
- ⑩ USB Upstream Connector (🔌) *
- ⑪ Keyhole for Security Lock

NOTE You can fasten a security lock and cable to prevent the monitor from being removed without your permission.

- ⑫ VGA Connector (D-SUB)
- ⑬ HDMI Connector (HDMI)
- ⑭ DisplayPort Connector (DP)
- ⑮ Cable Hole
- ⑯ Headphone Connector (🎧)
- ⑰ Audio Connector (LINE IN)
- ⑱ AC Connector (⚡ : Alternating current) (⚡)

* Available for ProLite XUB2294HSU only.

CONTROLS AND CONNECTORS :

ProLite XU2294HSU / ProLite XU2294HS / ProLite XU2292HS

ENGLISH

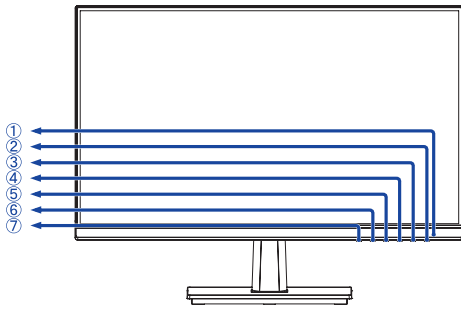

<Front>

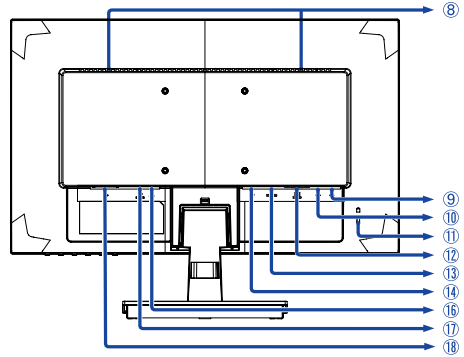

<Back>

① Power Indicator

NOTE Blue: Normal operation
Orange: Power Management

② Power Switch (⏻)

③ Menu / Select Button (MENU)

④ Scroll Up / Volume Button (▶ / 🔊)

⑤ Scroll Down / ECO Mode Button (◀ / ⏻)

⑥ Exit Button (EXIT)

⑦ Input Select Button (INPUT)

⑧ Speakers

⑨ USB Downstream Connector (🔌) *

⑩ USB Upstream Connector (🔌) *

⑪ Keyhole for Security Lock

NOTE You can fasten a security lock and cable to prevent the monitor from being removed without your permission.

⑫ VGA Connector (D-SUB)

⑬ HDMI Connector (HDMI)

⑭ DisplayPort Connector (DP)

⑯ Headphone Connector (🎧)

⑰ Audio Connector (LINE IN)

⑱ AC Connector (⚡ : Alternating current) (⚡)

* Available for ProLite XU2294HSU only.

CONNECTING YOUR MONITOR : ProLite XUB2294HSU

- ① Ensure that both the computer and the monitor are switched off.
- ② Connect the computer to the monitor with the signal cable.
- ③ Connect the monitor to the audio equipment with the Audio Cable for computer when using the audio features.
- ④ Connect the Power Cable to the monitor first and then to the power source.
- ⑤ Turn on your monitor and computer.

NOTE

- The signal cables used for connecting the computer and monitor may vary with the type of computer used. An incorrect connection may cause serious damage to both the monitor and the computer. The cable supplied with the monitor is for a standard connector. If a special cable is required please contact your local iiyama dealer or regional iiyama office.
- For connection to Macintosh computers, contact your local iiyama dealer or regional iiyama office for a suitable adaptor.
- Make sure you tighten the finger screws at each end of the signal cable.
- The Class I pluggable equipment Type A must be connected to protective earth.
- The socket-outlet shall be installed near the equipment and shall be easily accessible.
- Excessive sound pressure from ear-/headphones can cause hearing damage/hearing loss.

[Example of Connection]

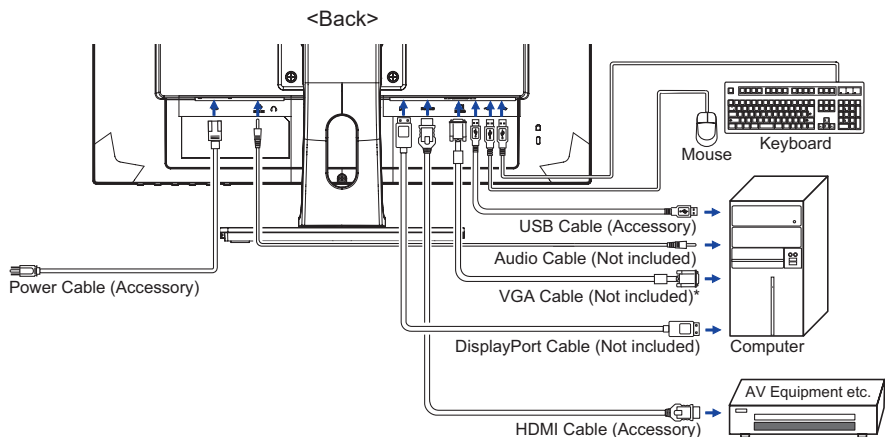

* VGA cable is not supplied with the monitor. If you use low quality VGA cable, it may cause a result of electro-magnetic interference. Please contact the iiyama Support Centre in your country if you wish to connect the monitor via the VGA input.

[Collect Cables]

Put the cables through the cable hole to bundle them.

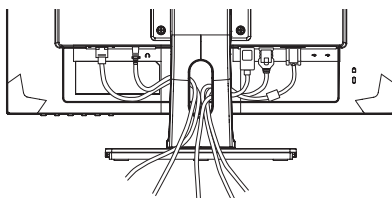

CONNECTING YOUR MONITOR : ProLite XUB2294HS / ProLite XUB2294HS

- ① Ensure that both the computer and the monitor are switched off.
- ② Connect the computer to the monitor with the signal cable.
- ③ Connect the monitor to the audio equipment with the Audio Cable for computer when using the audio features.
- ④ Connect the Power Cable to the monitor first and then to the power source.
- ⑤ Turn on your monitor and computer.

NOTE

- The signal cables used for connecting the computer and monitor may vary with the type of computer used. An incorrect connection may cause serious damage to both the monitor and the computer. The cable supplied with the monitor is for a standard connector. If a special cable is required please contact your local iiyama dealer or regional iiyama office.
- For connection to Macintosh computers, contact your local iiyama dealer or regional iiyama office for a suitable adaptor.
- Make sure you tighten the finger screws at each end of the signal cable.
- The Class I pluggable equipment Type A must be connected to protective earth.
- The socket-outlet shall be installed near the equipment and shall be easily accessible.
- Excessive sound pressure from ear-/headphones can cause hearing damage/hearing loss.

[Example of Connection]

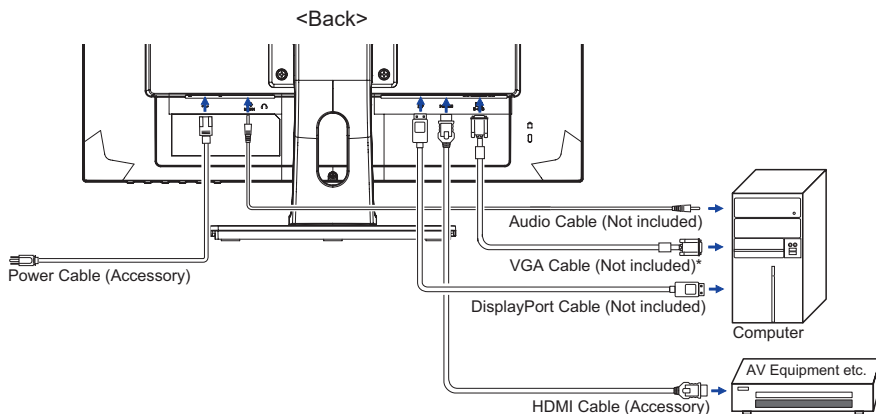

* VGA cable is not supplied with the monitor. If you use low quality VGA cable, it may cause a result of electro-magnetic interference. Please contact the iiyama Support Centre in your country if you wish to connect the monitor via the VGA input.

[Collect Cables]

Put the cables through the cable hole to bundle them.

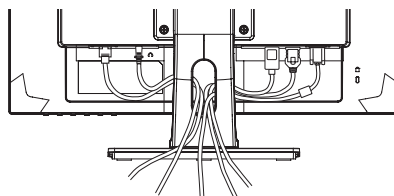

CONNECTING YOUR MONITOR : ProLite XU2294HSU

- ① Ensure that both the computer and the monitor are switched off.
- ② Connect the computer to the monitor with the signal cable.
- ③ Connect the monitor to the audio equipment with the Audio Cable for computer when using the audio features.
- ④ Connect the Power Cable to the monitor first and then to the power source.
- ⑤ Turn on your monitor and computer.

NOTE

- The signal cables used for connecting the computer and monitor may vary with the type of computer used. An incorrect connection may cause serious damage to both the monitor and the computer. The cable supplied with the monitor is for a standard connector. If a special cable is required please contact your local iiyama dealer or regional iiyama office.
- For connection to Macintosh computers, contact your local iiyama dealer or regional iiyama office for a suitable adaptor.
- Make sure you tighten the finger screws at each end of the signal cable.
- The Class I pluggable equipment Type A must be connected to protective earth.
- The socket-outlet shall be installed near the equipment and shall be easily accessible.
- Excessive sound pressure from ear-/headphones can cause hearing damage/hearing loss.

[Example of Connection]

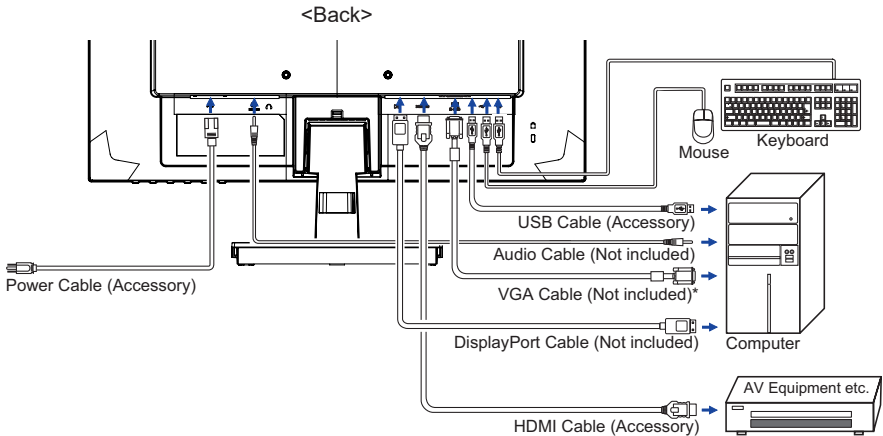

* VGA cable is not supplied with the monitor. If you use low quality VGA cable, it may cause a result of electro-magnetic interference. Please contact the iiyama Support Centre in your country if you wish to connect the monitor via the VGA input.

[Collect Cables]

Put the cables through the cable holder to bundle them.

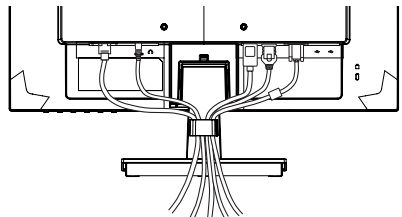

BEFORE YOU OPERATE THE MONITOR 13

CONNECTING YOUR MONITOR : ProLite XU2294HS / ProLite XU2292HS

- ① Ensure that both the computer and the monitor are switched off.
- ② Connect the computer to the monitor with the signal cable.
- ③ Connect the monitor to the audio equipment with the Audio Cable for computer when using the audio features.
- ④ Connect the Power Cable to the monitor first and then to the power source.
- ⑤ Turn on your monitor and computer.

NOTE

- The signal cables used for connecting the computer and monitor may vary with the type of computer used. An incorrect connection may cause serious damage to both the monitor and the computer. The cable supplied with the monitor is for a standard connector. If a special cable is required please contact your local iiyama dealer or regional iiyama office.
- For connection to Macintosh computers, contact your local iiyama dealer or regional iiyama office for a suitable adaptor.
- Make sure you tighten the finger screws at each end of the signal cable.
- The Class I pluggable equipment Type A must be connected to protective earth.
- The socket-outlet shall be installed near the equipment and shall be easily accessible.
- Excessive sound pressure from ear-/headphones can cause hearing damage/hearing loss.

[Example of Connection]

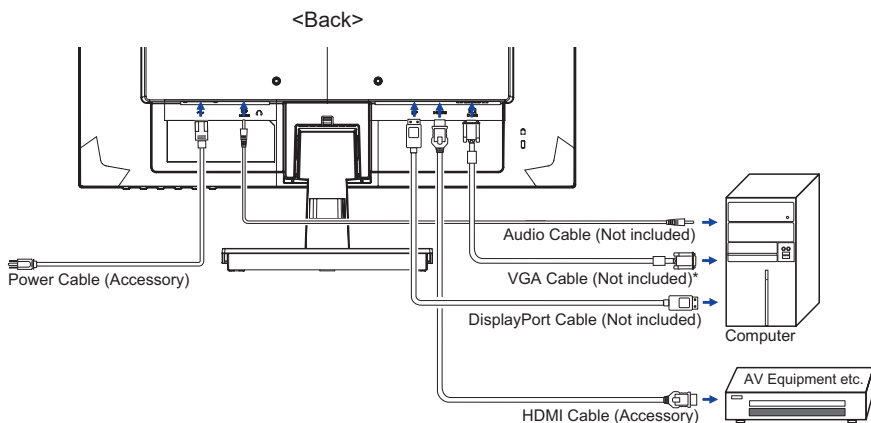

* VGA cable is not supplied with the monitor. If you use low quality VGA cable, it may cause a result of electro-magnetic interference. Please contact the iiyama Support Centre in your country if you wish to connect the monitor via the VGA input.

[Collect Cables]

Put the cables through the cable holder to bundle them.

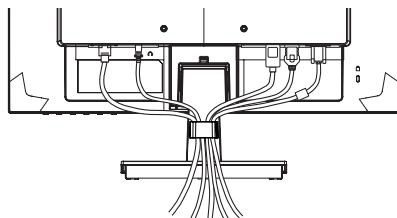

COMPUTER SETTING

■ Signal Timing

Change to the desired signal timing listed on page 41: COMPLIANT TIMING.

ADJUSTING THE HEIGHT AND THE VIEWING ANGLE : ProLite XUB2294HSU / ProLite XUB2294HS / ProLite XUB2292HS

- For optimal viewing it is recommended to position yourself directly opposite to the full face of the monitor, then adjust the monitor's height and angle to your own preference.
- Hold the panel so that the monitor does not topple when you change the monitor's height or angle.
- You are able to adjust the monitor's height up to 130mm, angle up to 45 degrees right and left, 22 degrees upward and 5 degrees downward.

NOTE

- Do not touch the LCD screen when you change the height or the angle. It may cause damage or break the LCD screen.
- Careful attention is required not to pinch your fingers or hands into the moving part of the stand when you change the angle.
- Injury can occur if care is not taken to avoid finger contact with the displays base when adjusting the height.

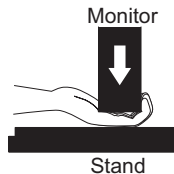
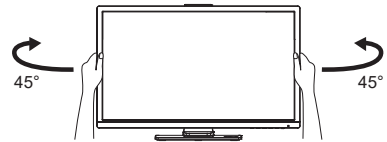
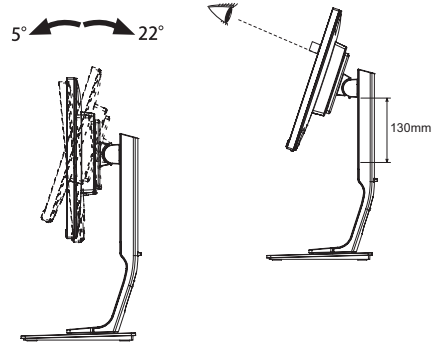

ADJUSTING THE VIEWING ANGLE : ProLite XU2294HSU / ProLite XU2294HS / ProLite XU2292HS

- For optimal viewing it is recommended to look at the full face of the monitor.
- Hold the stand so that the monitor does not topple when you change the monitor's angle.
- You are able to adjust the monitor's angle up to 22° upward, 5° downward.
- In order to ensure a healthy and relaxed body position when using the monitor at visual display workstations, it is recommended that the adjusted tilt angle should not exceed 10 degrees. Adjust the monitor's angle to your own preference.

NOTE

- Do not touch the LCD screen when you change the angle. It may cause damage or break the LCD screen.
- Careful attention is required not to pinch your fingers or hands into the moving part of the stand when you change the angle.

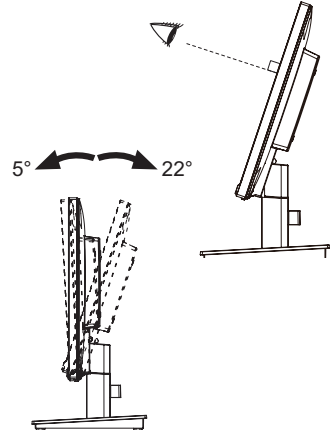

OPERATING THE MONITOR

To create the best picture, your iiyama LCD monitor has been preset at the factory with the COMPLIANT TIMING shown on page 41. You are also able to adjust the picture by following the button operation shown below. For more detailed adjustments, see page 28 for SCREEN ADJUSTMENTS.

- ① Press the MENU Button to start the On Screen Display feature. There are additional Menu items which can be switched by using the ◀/▶ Buttons.



- ② Select the Menu item which contains the adjustment icon relating to the adjustment you want to make. Press the MENU Button. Then, use the ◀/▶ Buttons to highlight the desired adjustment icon.
- ③ Press the MENU Button again. Use the ◀/▶ Buttons to make the appropriate adjustment or setting.
- ④ Press the EXIT Button to leave the menu, and the settings you just made would be automatically saved.

For example, to correct for vertical position, select Menu item of Geometry and then press the MENU Button. Then, select Vertical Position by using the ◀/▶ Buttons.

An adjustment page appears after you press the MENU Button. Then, use the ◀/▶ Buttons to change the vertical position settings. The vertical position of the overall display should be changing accordingly while you are doing this.



Press the EXIT Button lastly, it ends, all changes are saved in the memory.

NOTE

- When button operations are aborted during adjustment, On-Screen Display disappears when the time set for the OSD Timeout has passed. Also, press the EXIT button to quickly turn off the On-Screen Display.
- Any changes are automatically saved in the memory when the On Screen Display disappears. Turning off the power should be avoided while using the Menu.
- Adjustments for Horizontal / Vertical Position, Pixel Clock and Phase are saved for each signal timing. Except for these adjustments, all other adjustments have only one setting which applies to all signal timings.

ADJUSTMENT MENU CONTENTS

Auto Adjust



Adjustment Item	Problem / Option	Button to Press
Auto Adjust *	Adjust H. / V. Position, Clock and Phase automatically.	

* Only Analog Input.

For best results, use the Auto Adjust in conjunction with the adjustment pattern. See page 26 for SCREEN ADJUSTMENTS.



Picture Adjust *1

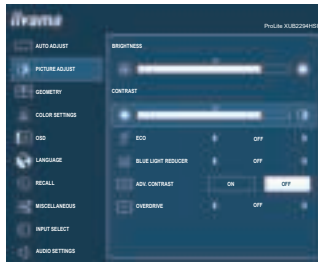

Adjustment Item	Problem / Option	Button to Press
Brightness *2,3,4	Too dark Too bright	
Contrast *3	Too dull Too intense	
ECO Direct	Off	Normal
	Mode1	Brightness of back-light is reduced.
	Mode2	Brightness of back-light is reduced more than Mode1.
	Mode3	Brightness of back-light is reduced more than Mode2.
Blue Light Reducer	Off	Typical
	Mode1	Blue light is reduced.
	Mode2	Blue light is reduced more than Mode1.
	Mode3	Blue light is reduced more than Mode2.
Adv. Contrast	On	Increased Contrast Ratio
	Off	Typical Contrast Ratio
Overdrive	Off / 1 / 2 / 3 It will improve the gray level response time of the LCD panel. A higher level results in a faster response time.	

*1 Picture Adjust is disabled when i-Style Color is activated.

*2 Adjust the Brightness when you are using the monitor in a dark room and feel the screen is too bright.

*3 Contrast and Brightness adjustments are disabled when Adv. Contrast mode is activated.

*4 Brightness adjustment is disabled when ECO is activated.

Direct





















You can skip the Menu items and directly display an option setting screen by using the following button operations.

- ECO : Press the Button when the Menu is not displayed.



Geometry *



Adjustment Item	Problem / Option	Button to Press
Horizontal Position	 Too left	 
	 Too right	 
Vertical Position	 Too low	 
	 Too high	 
Pixel Clock	 Too narrow	 
	 Too wide	 
Phase	To correct flickering text or lines	 

* Only Analog Input.

See page 28 for SCREEN ADJUSTMENTS.



Adjustment Item	Problem / Option	Button to Press
Color Temperature *1	9300K	
	7500K	
	6500K	
User Preset *1	Red	Too weak Too strong
	Green	
	Blue	
i-Style Color *2	Off	Return to a state set by color adjustment except i-Style Color.
	Standard	For general windows environment and monitor default setting.
	Game	For PC game environment.
	Cinema	For movie and video environment.
	Scenery	For displaying outdoor scenery images
	Text	For text editing and viewing in a word processing environment.

Direct

*1 Color Temperature and User Preset settings are disabled when i-Style Color or Blue Light Reducer is activated.









*2 i-Style Color adjustment is disabled when Blue Light Reducer is activated.

Direct

You can skip the Menu items and directly display an option setting screen by using the following button operations.

- i-Style Color : Press the EXIT Button when the Menu is not displayed.



Adjustment Item	Problem / Option	Button to Press
OSD Horizontal Position	OSD is too left OSD is too right	 
OSD Vertical Position	OSD is too low OSD is too high	 
OSD Rotate *	Rotate the OSD. 0° (Normal) / +90° (Rotate right) / -90° (Rotate left)	 
OSD Time	You can set the OSD display duration time between 5 and 30 seconds.	 

* Available for ProLite XUB2294HSU / ProLite XUB2294HS / ProLite XUB2292HS only.



Language

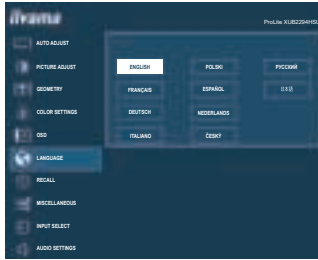

Adjustment Item	Problem / Option				Button to Press
Language	English	English	Español	Spanish	
	Français	French	Nederlands	Dutch	
	Deutsch	German	Česky	Czech	
	Italiano	Italian	Русский	Russian	
	Polski	Polish	日本語	Japanese	



ENGLISH

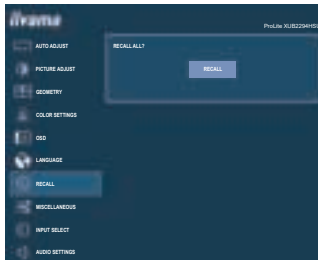

Recall



Adjustment Item	Problem / Option		Button to Press
Recall	Factory-preset data is restored.		

Adjustment Item		Problem / Option	Button to Press
Sharp and Soft		1 2 3 4 5 6 You can change the picture quality from 1 to 6 (sharp to soft). Press the ► Button to change the picture quality in numerical order. Press the ◀ Button to change the picture quality in reverse numerical order.	 
Video Mode Adjust		Full	Full screen display
		Aspect *	Expansion display of Aspect
Opening Logo		On	iiyama Logo is displayed when the monitor is turned on.
		Off	iiyama Logo is not displayed when the monitor is turned on.
Display Information		Displays information regarding the current input signal coming from the graphic card in your computer. NOTE See your graphic card user guide for more information about changing the resolution and refresh.	

* Option is unavailable with 16:9 resolution.



Input Select

Direct



Adjustment Item	Problem / Option		Button to Press
Input Source	Auto	Search for an available input source and select automatically.	
	Manual	VGA	Select the Analog (VGA) input.
		HDMI	Select the Digital (HDMI) input.
		DisplayPort	Select the Digital (DisplayPort) input.

NOTE Input source is fixed and it will not be detected automatically when you select VGA, HDMI or DisplayPort.

Direct







You can skip the Menu items and directly display an option setting screen by using the following button operations.

- Input Select : Press the INPUT Button when the Menu is not displayed.



Audio Settings



Adjustment Item	Problem / Option		Button to Press
Volume Direct	Too soft Too loud		 
Mute Audio	On	Turn off the sound temporarily.	
	Off	Return the sound volume to the previous level.	
NOTE Press the  () Button to display the volume adjustment bar and switch On and Off the Mute function by pressing the  /  Buttons.			
Audio Input *	HDMI	Select the HDMI input.	
	DP	Select the DisplayPort input.	
	LINE-IN	Select the Line-In input.	

* For HDMI/DisplayPort inputs only.

Direct

You can skip the Menu items and directly display an adjustment scale by using the following button operations.

- Volume : Press the  Button when the Menu is not displayed.

■ Lock Mode

<OSD Menu>

The OSD can be locked to avoid an accidental setting change.

1. Make sure the monitor is turned ON.
2. The OSD lock will be activated by pressing the front MENU Button for about 10 seconds. If you try to access the OSD by pressing any of the buttons, a message "OSD Locked" will appear on the screen.
3. The OSD lock will be deactivated by pressing the front MENU Button again for about 10 seconds.

<Power Switch>

The Power Switch can be locked to avoid an accidental power operation.

1. Make sure the monitor is turned ON.
2. The Power Switch lock will be activated by pressing the front ◀ Button for about 10 seconds. If you try to turn off the monitor by pressing the Power Switch, a message "Power Button Locked" will appear on the screen.
3. The Power Switch lock will be deactivated by pressing the front ◀ Button again for about 10 seconds.

SCREEN ADJUSTMENTS

Adjust the image by following the procedure below to get the desired picture when selecting Analog input.

- The screen adjustments described in this manual are designed to set image position and minimize flicker or blur for the particular computer in use.
- The monitor is designed to provide the best performance at resolution of 1920 × 1080, but can not provide the best at resolutions of less than 1920 × 1080 because the picture is automatically stretched to fit the full screen. It is recommended to operate at resolution of 1920 × 1080 in normal use.
- Displayed text or lines will be blurred or irregular in thickness when the picture is stretched due to the screen enlargement process.
- It is preferable to adjust the image position and frequency with the monitor controls, rather than the computer software or utilities.
- Perform adjustments after a warm-up period of at least thirty minutes.
- Additional adjustments may be required after the Auto Adjust depending on the resolution or signal timing.
- The Auto Adjust may not work correctly when displaying the picture other than the screen adjustment pattern. In this case, manual adjustments are required.

There are two ways to adjust the screen. One way is automatic adjustment for Position, Pixel Clock and Phase. The other way is performing each adjustment manually.

Perform the Auto Adjust first when the monitor is connected to a new computer, or resolution is changed. If the screen has a flicker or blur, or the picture does not fit in the display area after performing the Auto Adjust, manual adjustments are required. Both adjustments should be made by using the screen adjustment pattern (Test.bmp) obtained via the Iiyama web site (<http://www.iiyama.com>).

Adjust the image by following the procedure below to get the desired picture.

This manual explains adjustment under Windows® OS.

- ① **Display the picture at the optimum resolution.**
- ② **Enter the Test.bmp (screen adjustment pattern) to wallpaper.**

NOTE

- Consult the appropriate documentation for doing this.
- Set the display position to center in the wallpaper setting dialogue box.

[Adjustment pattern]

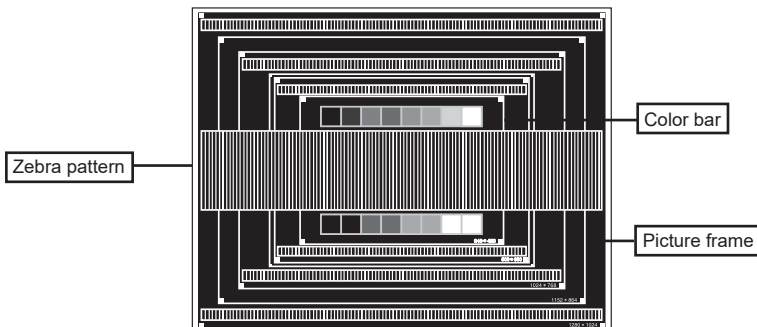

- ③ Adjust the Auto Adjustment. (Auto Adjust)
- ④ Adjust the image manually by following procedure below when the screen has a flicker or blur, or the picture does not fit in the display area after performing the Auto Adjust.
- ⑤ Adjust the V.Position so that the top and bottom of the picture frame will fit to the display area.

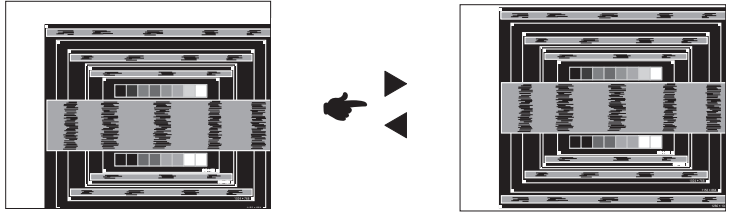

- ⑥ 1) Adjust the H.Position so that the left side of the picture frame will move to the left edge of the display area.

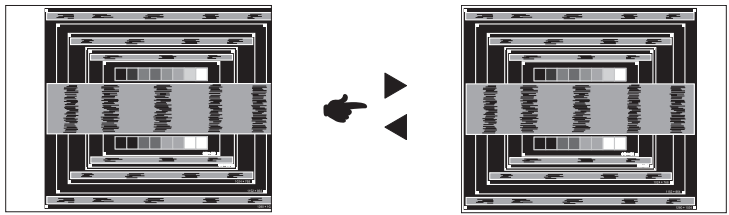

- 2) Stretch the right side of the picture frame to the right edge of the display area by adjusting the Pixel Clock.

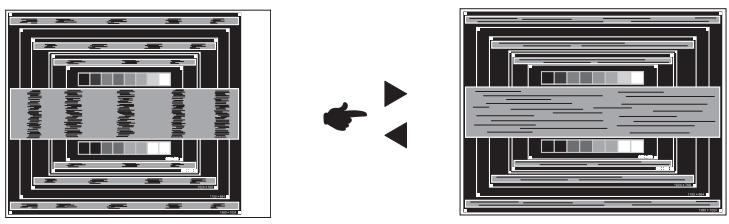

- NOTE**
- When the left side of the picture frame moves apart from the left edge of the display area during the Pixel Clock adjustment, adjust steps 1) and 2).
 - Another way to make the Pixel Clock adjustment is to correct the vertical wavy lines in the zebra pattern.
 - The picture may flicker during the Pixel Clock, H.Position and V.Position adjustment.
 - In case the picture frame is bigger or smaller than the data display area after the Pixel Clock adjustment, repeat steps from ③.

- ⑦ **Adjust the Phase to correct horizontal wavy noise, flicker or blur in the zebra pattern.**

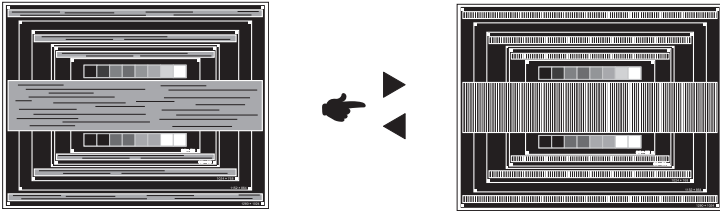

NOTE

- In case the strong flicker or blurs remain on a part of the screen, repeat steps ⑥ and ⑦ because the Pixel Clock may not be adjusted correctly.
- Adjust the H.Position after the Phase adjustment if the horizontal position moves during the adjustment.

- ⑧ **Adjust the Brightness and Color to get the desired picture after you complete the Pixel Clock and Phase adjustments.**

Put back your favorite wallpaper.

POWER MANAGEMENT FEATURE

The power management feature of this product complies with power saving requirement of VESA DPMS. When activated, it automatically reduces unnecessary power consumption of the monitor when your computer is not in use.

To use the feature, the monitor needs to be connected to a VESA DPMS compliant computer. There is a power management step the monitor takes as described below. The power management function, including any timer settings is configured by the operating system. Check your operating system manual for information on how this can be configured.

■ Power Management Mode

When the H-sync signal / V-sync signal / H and V sync signals from the computer are off, the monitor enters into Power Management Mode which reduces the power consumption to less than 0.5W. The screen becomes dark, and the power indicator turns to orange. From Power Management Mode, the image reappears in several seconds when either the keyboard or the mouse are touched again.

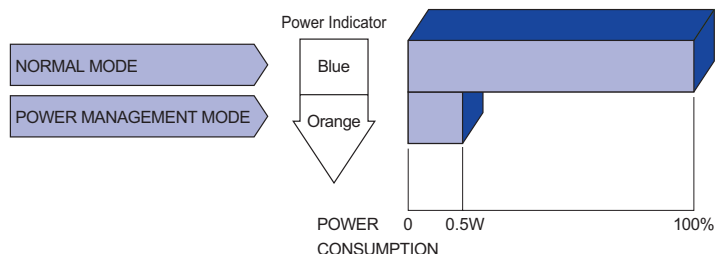

NOTE

- Even when using the power management mode, the monitor consumes electricity. Turn off the Power Switch whenever the monitor is not in use, during the night and weekends, to avoid unnecessary power consumption.
- It is possible that the video signal from the computer may be on while the H or V sync signal is missing. In this instance, the POWER MANAGEMENT feature may not work properly.

TROUBLE SHOOTING

If the monitor fails to operate correctly, please follow the steps below for a possible solution.

1. Perform the adjustments described in OPERATING THE MONITOR, depending on the problem you have. If the monitor does not get a picture, skip to 2.
2. Consult the following items if you cannot find an appropriate adjustment item in OPERATING THE MONITOR or if the problem persists.
3. If you are experiencing a problem which is not described below or you cannot correct the problem, discontinue using the monitor and contact your dealer or iiyama service center for further assistance.

Problem

Check

- | | |
|---|---|
| <p>① The picture does not appear.</p> <p>(Power indicator does not light up.)</p> <p>(Power indicator is blue.)</p> <p>(Power indicator is orange.)</p> | <p><input type="checkbox"/> The Power Cable is firmly seated in the socket.</p> <p><input type="checkbox"/> The Power Switch is turned ON.</p> <p><input type="checkbox"/> The AC socket is live. Please check with another piece of equipment.</p> <p><input type="checkbox"/> If the blank screen saver is in active mode, touch the keyboard or the mouse.</p> <p><input type="checkbox"/> Increase the Contrast and/or Brightness.</p> <p><input type="checkbox"/> The computer is ON.</p> <p><input type="checkbox"/> The Signal Cable is properly connected.</p> <p><input type="checkbox"/> The signal timing of the computer is within the specification of the monitor.</p> <p><input type="checkbox"/> If the monitor is in power management mode, touch the keyboard or the mouse.</p> <p><input type="checkbox"/> The computer is ON.</p> <p><input type="checkbox"/> The Signal Cable is properly connected.</p> <p><input type="checkbox"/> The signal timing of the computer is within the specification of the monitor.</p> |
| <p>② The screen is not synchronized.</p> | <p><input type="checkbox"/> The Signal Cable is properly connected.</p> <p><input type="checkbox"/> The signal timing of the computer is within the specification of the monitor.</p> <p><input type="checkbox"/> The video output level of the computer is within the specification of the monitor.</p> |
| <p>③ The screen position is not in the center.</p> | <p><input type="checkbox"/> The signal timing of the computer is within the specification of the monitor.</p> |
| <p>④ The screen is too bright or too dark.</p> | <p><input type="checkbox"/> The video output level of the computer is within the specification of the monitor.</p> |

Problem

Check

- | | |
|---------------------------------------|---|
| ⑤ The screen is shaking. | <input type="checkbox"/> The power voltage is within the specification of the monitor.
<input type="checkbox"/> The signal timing of the computer is within the specification of the monitor. |
| ⑥ No sound. | <input type="checkbox"/> The audio equipment (computer etc.) is ON.
<input type="checkbox"/> The Audio Cable is properly connected.
<input type="checkbox"/> The Volume is turned up.
<input type="checkbox"/> The Mute is ON.
<input type="checkbox"/> The audio output level of the audio equipment is within the specification of the monitor. |
| ⑦ The sound is too loud or too quiet. | <input type="checkbox"/> The audio output level of the audio equipment is within the specification of the monitor. |
| ⑧ A strange noise is heard. | <input type="checkbox"/> The Audio Cable is properly connected. |

RECYCLING INFORMATION

For better environment protection please don't dispose your monitor.
Please visit our web site: www.iiyama.com for monitor recycling.

APPENDIX

Design and specifications are subject to change without prior notice.

SPECIFICATIONS : ProLite XUB2294HSU

ENGLISH

Size Category	22"	
LCD Panel	Panel technology	VA
	Size	Diagonal: 21.5" (54.6cm)
	Pixel pitch	0.248mm H × 0.248mm V
	Brightness	250cd/m ² (Typical)
	Contrast ratio	3000 : 1 (Typical), Adv. Contrast Function Available
	Viewable angle	Right / Left : 89 degrees each, Up / Down : 89 degrees each (Typical)
	Response time	4ms (Gray to Gray)
Display Colors	Approx. 16.7M	
Sync Frequency	VGA : Horizontal: 30.0-83.0kHz, Vertical: 55-75Hz HDMI/DisplayPort : Horizontal: 30.0-85.0kHz, Vertical: 55-75Hz	
Native Resolution	1920 × 1080, 2.1 MegaPixels	
Support max. resolution	VGA: 1920 × 1080 60Hz HDMI: 1920 × 1080 75Hz DisplayPort: 1920 × 1080 75Hz	
Input Connector	VGA, HDMI, DisplayPort	
Plug & Play	VESA DDC2B™	
Input Sync Signal	Separate sync: TTL, Positive or Negative	
Input Video Signal	Analog: 0.7Vp-p (Standard), 75Ω, Positive Digital: HDMI, DisplayPort	
USB Standard	USB2.0	
Number of USB Ports Connector shape	1 Upstream : Series B 2 Downstream : Series A	
Input Audio Connector	ø 3.5mm mini jack (Stereo)	
Input Audio Signal	1.0Vrms maximum	
Headphone Connector	ø 3.5mm mini jack (Stereo)	
Speakers	1W × 2 (Stereo speakers)	
Maximum Screen Size	476.0mm W × 267.8mm H / 18.7" W × 10.5" H	
Power Source	100-240VAC, 50/60Hz, 1.0A	
Power Consumption*	19W typical, Power management mode: 0.5W maximum Energy Efficiency Class: A+	
Dimensions / Net Weight	488.5 × 352.0 - 482.0 × 210.0mm / 19.2 × 13.9 - 19.0 × 8.3" (W×H×D) 4.7kg / 10.36lbs	
Angle	Tilt: Upward: 22 degrees, Downward: 5 degrees Swivel: Left / Right: 45 degrees each Rotation: Clockwise / Counterclockwise: 90 degrees each	
Environmental Considerations	Operating: Temperature 5 to 35°C / 41 to 95°F Humidity 10 to 80% (No condensation) Storage: Temperature -20 to 60°C / -4 to 140°F Humidity 5 to 85% (No condensation)	
Approvals	CE, TÜV-GS, VCCI-B, PSE, CU	

NOTE * USB peripherals and audio-video equipment are not connected.

SPECIFICATIONS : ProLite XUB2294HS

Size Category	22"	
LCD Panel	Panel technology	VA
	Size	Diagonal: 21.5" (54.6cm)
	Pixel pitch	0.248mm H × 0.248mm V
	Brightness	250cd/m ² (Typical)
	Contrast ratio	3000 : 1 (Typical), Adv. Contrast Function Available
	Viewable angle	Right / Left : 89 degrees each, Up / Down : 89 degrees each (Typical)
	Response time	4ms (Gray to Gray)
Display Colors	Approx. 16.7M	
Sync Frequency	VGA : Horizontal: 30.0-83.0kHz, Vertical: 55-75Hz HDMI/DisplayPort : Horizontal: 30.0-85.0kHz, Vertical: 55-75Hz	
Native Resolution	1920 × 1080, 2.1 MegaPixels	
Support max. resolution	VGA: 1920 × 1080 60Hz HDMI: 1920 × 1080 75Hz DisplayPort: 1920 × 1080 75Hz	
Input Connector	VGA, HDMI, DisplayPort	
Plug & Play	VESA DDC2B™	
Input Sync Signal	Separate sync: TTL, Positive or Negative	
Input Video Signal	Analog: 0.7Vp-p (Standard), 75Ω, Positive Digital: HDMI, DisplayPort	
Input Audio Connector	ø 3.5mm mini jack (Stereo)	
Input Audio Signal	1.0Vrms maximum	
Headphone Connector	ø 3.5mm mini jack (Stereo)	
Speakers	1W × 2 (Stereo speakers)	
Maximum Screen Size	476.0mm W × 267.8mm H / 18.7" W × 10.5" H	
Power Source	100-240VAC, 50/60Hz, 1.0A	
Power Consumption*	19W typical, Power management mode: 0.5W maximum Energy Efficiency Class: A+	
Dimensions / Net Weight	488.5 × 352.0 - 482.0 × 210.0mm / 19.2 × 13.9 - 19.0 × 8.3" (W×H×D) 4.6kg / 10.14lbs	
Angle	Tilt: Upward: 22 degrees, Downward: 5 degrees Swivel: Left / Right: 45 degrees each Rotation: Clockwise / Counterclockwise: 90 degrees each	
Environmental Considerations	Operating: Temperature 5 to 35°C / 41 to 95°F Humidity 10 to 80% (No condensation) Storage: Temperature -20 to 60°C / -4 to 140°F Humidity 5 to 85% (No condensation)	
Approvals	CE, TÜV-GS, VCCI-B, PSE, CU	

NOTE * Audio-video equipment is not connected.

SPECIFICATIONS : ProLite XUB2292HS

Size Category	22"	
LCD Panel	Panel technology	IPS Panel Technology
	Size	Diagonal: 21.5" (54.6cm)
	Pixel pitch	0.248mm H × 0.248mm V
	Brightness	250cd/m ² (Typical)
	Contrast ratio	1000 : 1 (Typical), Adv. Contrast Function Available
	Viewable angle	Right / Left : 89 degrees each, Up / Down : 89 degrees each (Typical)
	Response time	4ms (Gray to Gray)
Display Colors	Approx. 16.7M	
Sync Frequency	VGA : Horizontal: 30.0-83.0kHz, Vertical: 55-75Hz HDMI/DisplayPort : Horizontal: 30.0-85.0kHz, Vertical: 55-75Hz	
Native Resolution	1920 × 1080, 2.1 MegaPixels	
Support max. resolution	VGA: 1920 × 1080 60Hz HDMI: 1920 × 1080 75Hz DisplayPort: 1920 × 1080 75Hz	
Input Connector	VGA, HDMI, DisplayPort	
Plug & Play	VESA DDC2B™	
Input Sync Signal	Separate sync: TTL, Positive or Negative	
Input Video Signal	Analog: 0.7Vp-p (Standard), 75Ω, Positive Digital: HDMI, DisplayPort	
Input Audio Connector	ø 3.5mm mini jack (Stereo)	
Input Audio Signal	1.0Vrms maximum	
Headphone Connector	ø 3.5mm mini jack (Stereo)	
Speakers	1W × 2 (Stereo speakers)	
Maximum Screen Size	476.0mm W × 267.8mm H / 18.7" W × 10.5" H	
Power Source	100-240VAC, 50/60Hz, 1.0A	
Power Consumption*	18W typical, Power management mode: 0.5W maximum Energy Efficiency Class: A	
Dimensions / Net Weight	488.5 × 352.0 - 482.0 × 210.0mm / 19.2 × 13.9 - 19.0 × 8.3" (W×H×D) 4.8kg / 10.58lbs	
Angle	Tilt: Upward: 22 degrees, Downward: 5 degrees Swivel: Left / Right: 45 degrees each Rotation: Clockwise / Counterclockwise: 90 degrees each	
Environmental Considerations	Operating: Temperature 5 to 35°C / 41 to 95°F Humidity 10 to 80% (No condensation) Storage: Temperature -20 to 60°C / -4 to 140°F Humidity 5 to 85% (No condensation)	
Approvals	CE, TÜV-GS, VCCI-B, PSE, CU	

NOTE * Audio-video equipment is not connected.

SPECIFICATIONS : ProLite XU2294HSU

Size Category	22"	
LCD Panel	Panel technology	VA
	Size	Diagonal: 21.5" (54.6cm)
	Pixel pitch	0.248mm H × 0.248mm V
	Brightness	250cd/m ² (Typical)
	Contrast ratio	3000 : 1 (Typical), Adv. Contrast Function Available
	Viewable angle	Right / Left : 89 degrees each, Up / Down : 89 degrees each (Typical)
	Response time	4ms (Gray to Gray)
Display Colors	Approx. 16.7M	
Sync Frequency	VGA : Horizontal: 30.0-83.0kHz, Vertical: 55-75Hz HDMI/DisplayPort : Horizontal: 30.0-85.0kHz, Vertical: 55-75Hz	
Native Resolution	1920 × 1080, 2.1 MegaPixels	
Support max. resolution	VGA: 1920 × 1080 60Hz HDMI: 1920 × 1080 75Hz DisplayPort: 1920 × 1080 75Hz	
Input Connector	VGA, HDMI, DisplayPort	
Plug & Play	VESA DDC2B™	
Input Sync Signal	Separate sync: TTL, Positive or Negative	
Input Video Signal	Analog: 0.7Vp-p (Standard), 75Ω, Positive Digital: HDMI, DisplayPort	
USB Standard	USB2.0	
Number of USB Ports Connector shape	1 Upstream : Series B 2 Downstream : Series A	
Input Audio Connector	ø 3.5mm mini jack (Stereo)	
Input Audio Signal	1.0Vrms maximum	
Headphone Connector	ø 3.5mm mini jack (Stereo)	
Speakers	1W × 2 (Stereo speakers)	
Maximum Screen Size	476.0mm W × 267.8mm H / 18.7" W × 10.5" H	
Power Source	100-240VAC, 50/60Hz, 1.0A	
Power Consumption*	19W typical, Power management mode: 0.5W maximum Energy Efficiency Class: A+	
Dimensions / Net Weight	488.5 × 376.0 × 187.0mm / 19.2 × 14.8 × 7.4" (W×H×D) 3.0kg / 6.61lbs	
Tilt Angle	Upward: 22 degrees, Downward: 5 degrees	
Environmental Considerations	Operating:	Temperature 5 to 35°C / 41 to 95°F Humidity 10 to 80% (No condensation)
	Storage:	Temperature -20 to 60°C / -4 to 140°F Humidity 5 to 85% (No condensation)
Approvals	CE, TÜV-GS, VCCI-B, PSE, CU	

NOTE * USB peripherals and audio-video equipment are not connected.

SPECIFICATIONS : ProLite XU2294HS

Size Category	22"	
LCD Panel	Panel technology	VA
	Size	Diagonal: 21.5" (54.6cm)
	Pixel pitch	0.248mm H × 0.248mm V
	Brightness	250cd/m ² (Typical)
	Contrast ratio	3000 : 1 (Typical), Adv. Contrast Function Available
	Viewable angle	Right / Left : 89 degrees each, Up / Down : 89 degrees each (Typical)
	Response time	4ms (Gray to Gray)
Display Colors	Approx. 16.7M	
Sync Frequency	VGA : Horizontal: 30.0-83.0kHz, Vertical: 55-75Hz HDMI/DisplayPort : Horizontal: 30.0-85.0kHz, Vertical: 55-75Hz	
Native Resolution	1920 × 1080, 2.1 MegaPixels	
Support max. resolution	VGA: 1920 × 1080 60Hz HDMI: 1920 × 1080 75Hz DisplayPort: 1920 × 1080 75Hz	
Input Connector	VGA, HDMI, DisplayPort	
Plug & Play	VESA DDC2B™	
Input Sync Signal	Separate sync: TTL, Positive or Negative	
Input Video Signal	Analog: 0.7Vp-p (Standard), 75Ω, Positive Digital: HDMI, DisplayPort	
Input Audio Connector	ø 3.5mm mini jack (Stereo)	
Input Audio Signal	1.0Vrms maximum	
Headphone Connector	ø 3.5mm mini jack (Stereo)	
Speakers	1W × 2 (Stereo speakers)	
Maximum Screen Size	476.0mm W × 267.8mm H / 18.7" W × 10.5" H	
Power Source	100-240VAC, 50/60Hz, 1.0A	
Power Consumption*	19W typical, Power management mode: 0.5W maximum Energy Efficiency Class: A+	
Dimensions / Net Weight	488.5 × 376.0 × 187.0mm / 19.2 × 14.8 × 7.4" (W×H×D) 3.0kg / 6.61lbs	
Tilt Angle	Upward: 22 degrees, Downward: 5 degrees	
Environmental Considerations	Operating: Temperature 5 to 35°C / 41 to 95°F Humidity 10 to 80% (No condensation) Storage: Temperature -20 to 60°C / -4 to 140°F Humidity 5 to 85% (No condensation)	
Approvals	CE, TÜV-GS, VCCI-B, PSE, CU	

NOTE * Audio-video equipment is not connected.

SPECIFICATIONS : ProLite XU2292HS

Size Category	22"	
LCD Panel	Panel technology	IPS Panel Technology
	Size	Diagonal: 21.5" (54.6cm)
	Pixel pitch	0.248mm H × 0.248mm V
	Brightness	250cd/m ² (Typical)
	Contrast ratio	1000 : 1 (Typical), Adv. Contrast Function Available
	Viewable angle	Right / Left : 89 degrees each, Up / Down : 89 degrees each (Typical)
	Response time	4ms (Gray to Gray)
Display Colors	Approx. 16.7M	
Sync Frequency	VGA : Horizontal: 30.0-83.0kHz, Vertical: 55-75Hz HDMI/DisplayPort : Horizontal: 30.0-85.0kHz, Vertical: 55-75Hz	
Native Resolution	1920 × 1080, 2.1 MegaPixels	
Support max. resolution	VGA: 1920 × 1080 60Hz HDMI: 1920 × 1080 75Hz DisplayPort: 1920 × 1080 75Hz	
Input Connector	VGA, HDMI, DisplayPort	
Plug & Play	VESA DDC2B™	
Input Sync Signal	Separate sync: TTL, Positive or Negative	
Input Video Signal	Analog: 0.7Vp-p (Standard), 75Ω, Positive Digital: HDMI, DisplayPort	
Input Audio Connector	ø 3.5mm mini jack (Stereo)	
Input Audio Signal	1.0Vrms maximum	
Headphone Connector	ø 3.5mm mini jack (Stereo)	
Speakers	1W × 2 (Stereo speakers)	
Maximum Screen Size	476.0mm W × 267.8mm H / 18.7" W × 10.5" H	
Power Source	100-240VAC, 50/60Hz, 1.0A	
Power Consumption*	18W typical, Power management mode: 0.5W maximum Energy Efficiency Class: A	
Dimensions / Net Weight	488.5 × 376.0 × 187.0mm / 19.2 × 14.8 × 7.4" (W×H×D) 3.2kg / 7.05lbs	
Tilt Angle	Upward: 22 degrees, Downward: 5 degrees	
Environmental Considerations	Operating: Temperature 5 to 35°C / 41 to 95°F Humidity 10 to 80% (No condensation) Storage: Temperature -20 to 60°C / -4 to 140°F Humidity 5 to 85% (No condensation)	
Approvals	CE, TÜV-GS, VCCI-B, PSE, CU	

NOTE * Audio-video equipment is not connected.

DIMENSIONS :
ProLite XUB2294HSU / ProLite XUB2294HS / ProLite XUB2292HS

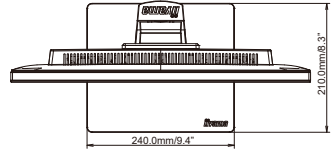
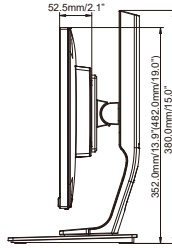
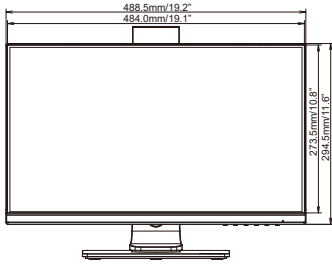

() : Maximum adjustment range

DIMENSIONS:
ProLite XU2294HSU / ProLite XU2294HS / ProLite XU2292HS

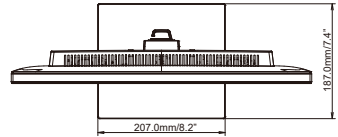
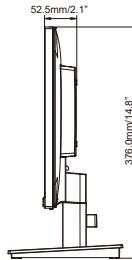
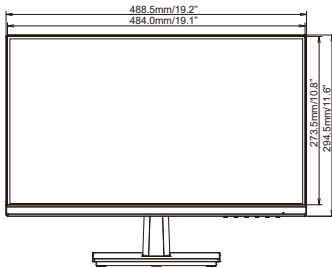

COMPLIANT TIMING

Video Mode	Horizontal Frequency	Vertical Frequency	Dot Clock
640 × 480	31.469kHz	59.940Hz	25.175MHz
800 × 600	37.879kHz	60.317Hz	40.000MHz
1024 × 768	48.363kHz	60.004Hz	65.000MHz
1280 × 1024	63.981kHz	60.020Hz	108.000MHz
1440 × 900	55.935kHz	59.887Hz	106.500MHz
1680 × 1050	65.290kHz	60.000Hz	146.250MHz
1920 × 1080	66.590kHz	59.930Hz	138.500MHz
	83.890kHz	74.970Hz	174.500MHz
640 × 350	31.469kHz	70.087Hz	25.175MHz
720 × 400	31.469kHz	70.087Hz	28.322MHz

NOTE *1 HDMI/DisplayPort input only.

*2 Analog input only.