

# QUICK START

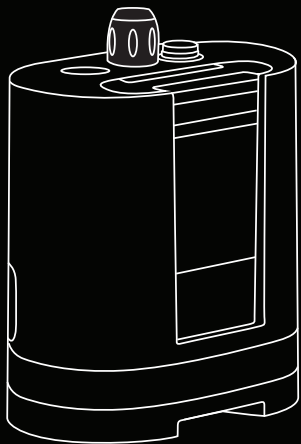

**DUALYS** PLUS

SteamOne



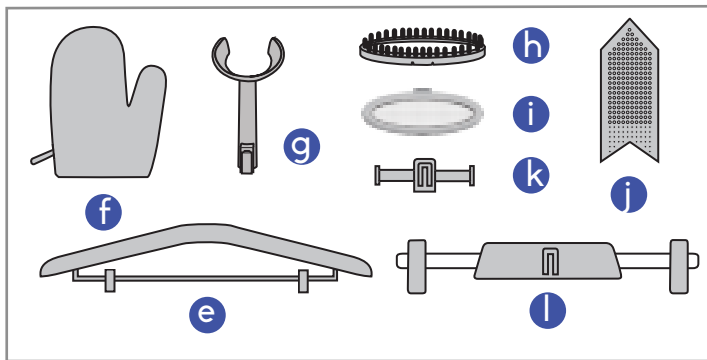
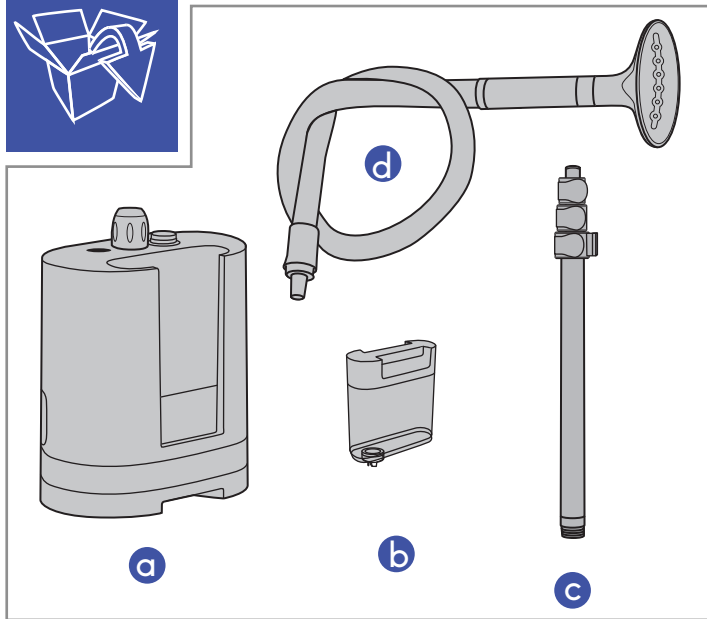

SteamOne

1

a + c

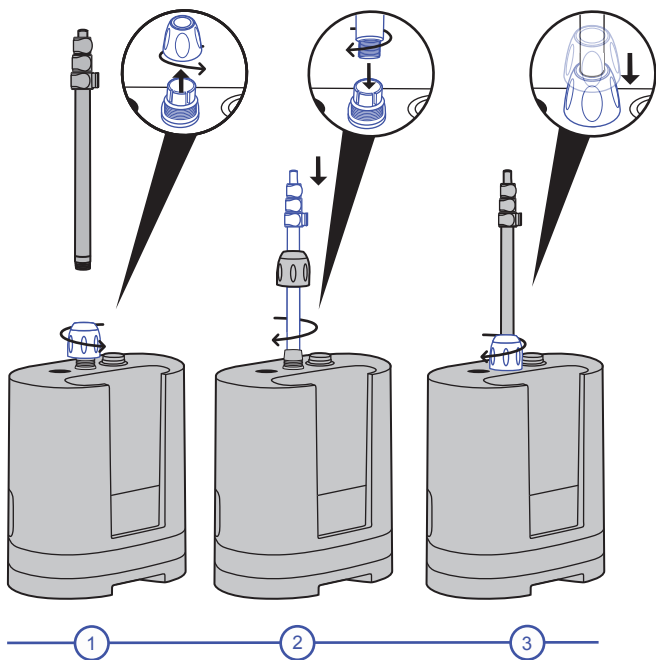

SteamOne

2

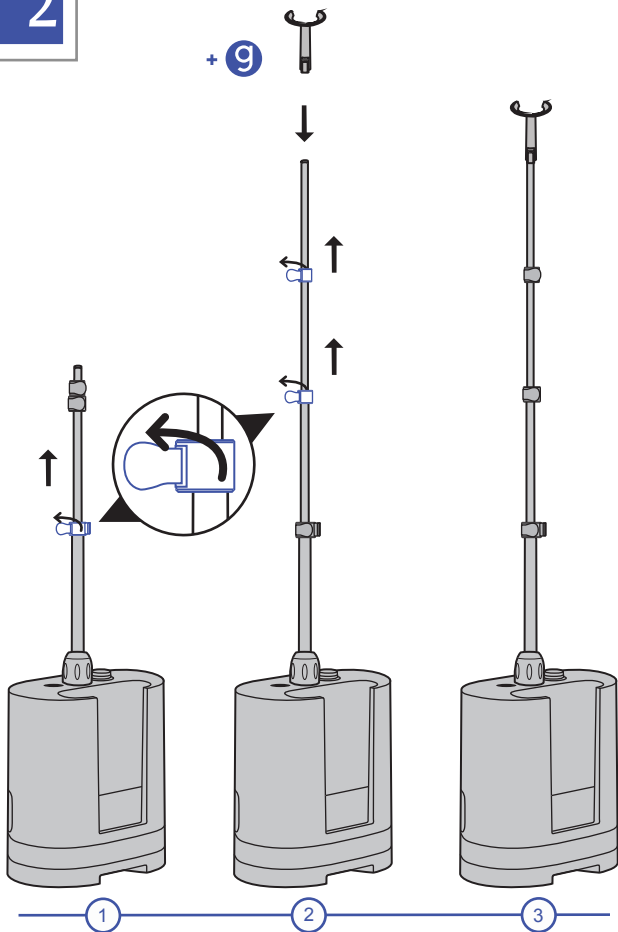

SteamOne

3

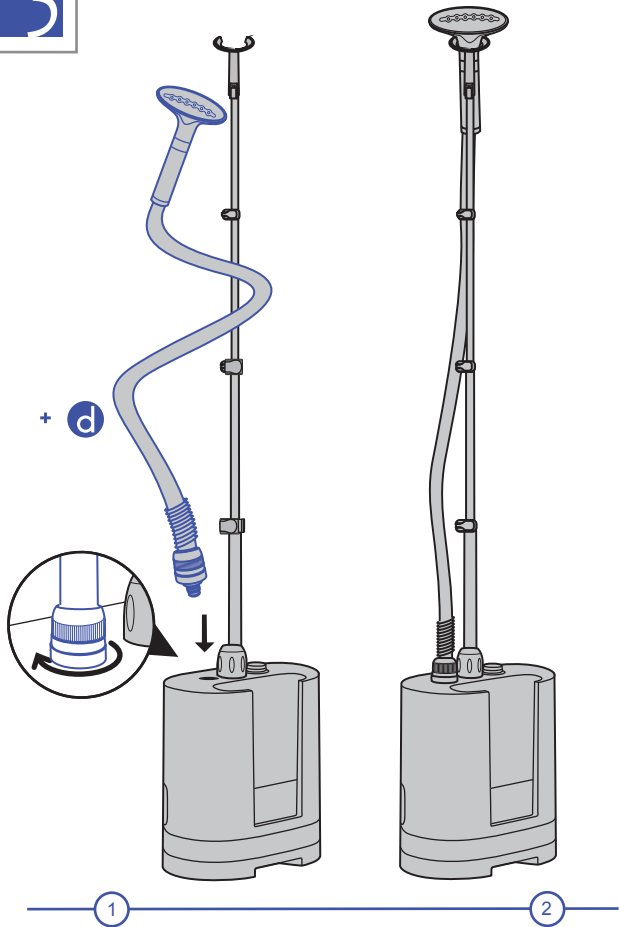

SteamOne

4

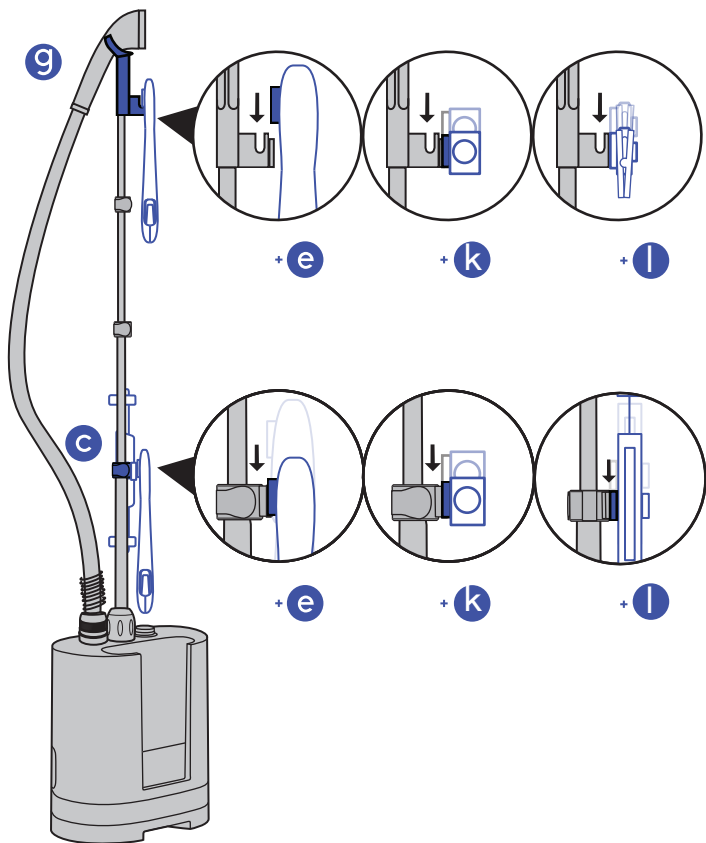

SteamOne

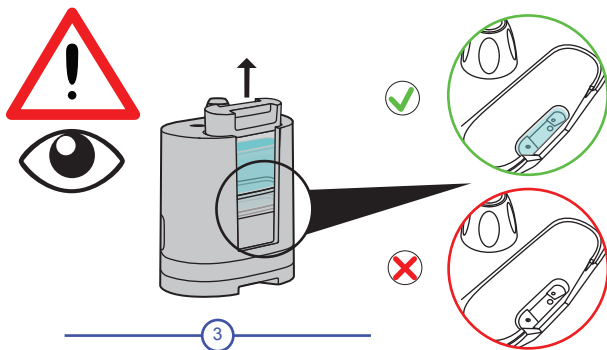
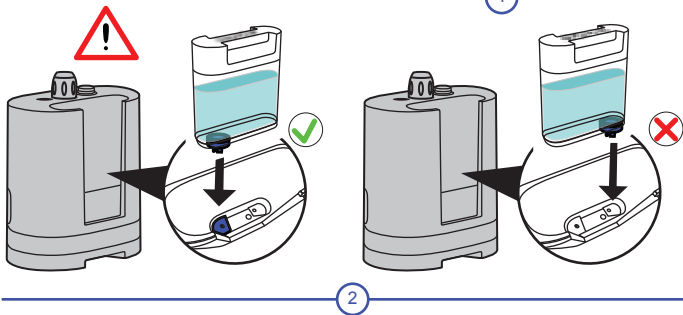
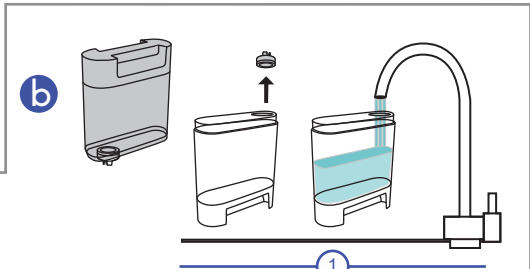

SteamOne



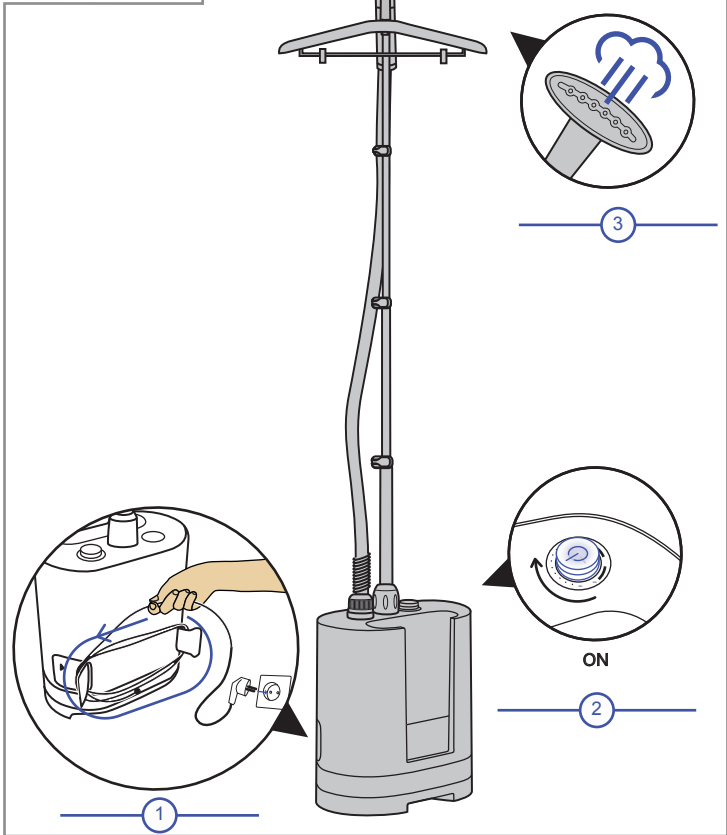
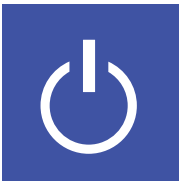

SteamOne



e + g

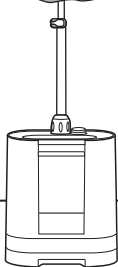
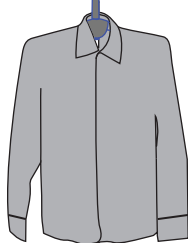

g

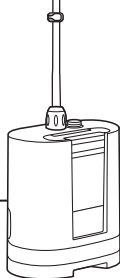

e + g

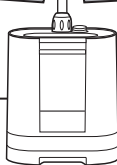
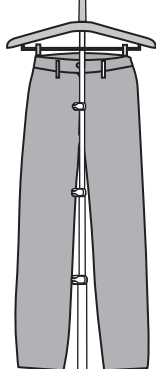

SteamOne



f + g

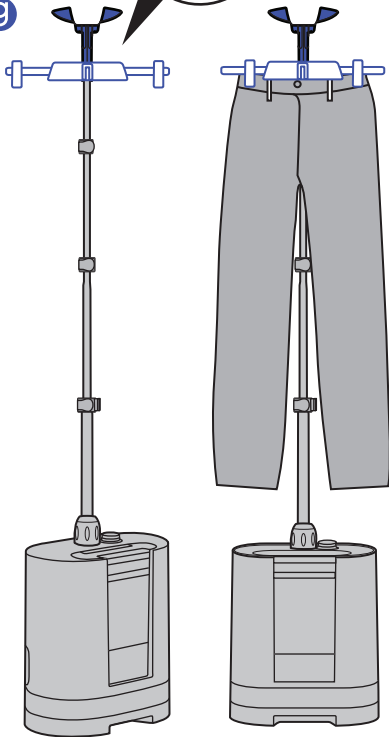
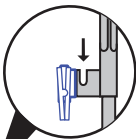

1

2

SteamOne



f + i

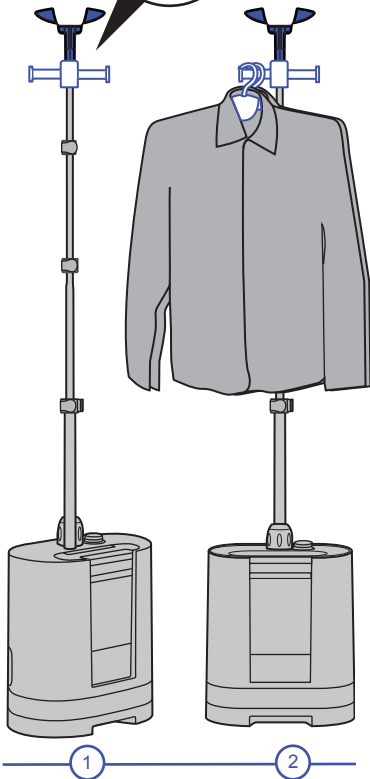
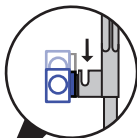

SteamOne

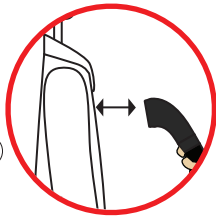

1



2

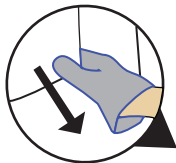

3

SteamOne



j

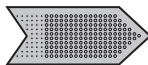

h



i

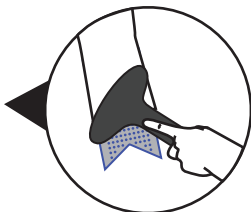
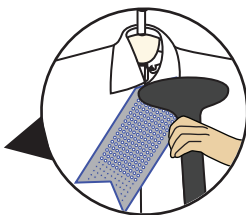
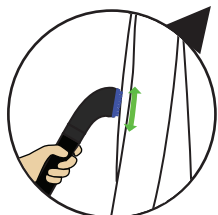

SteamOne

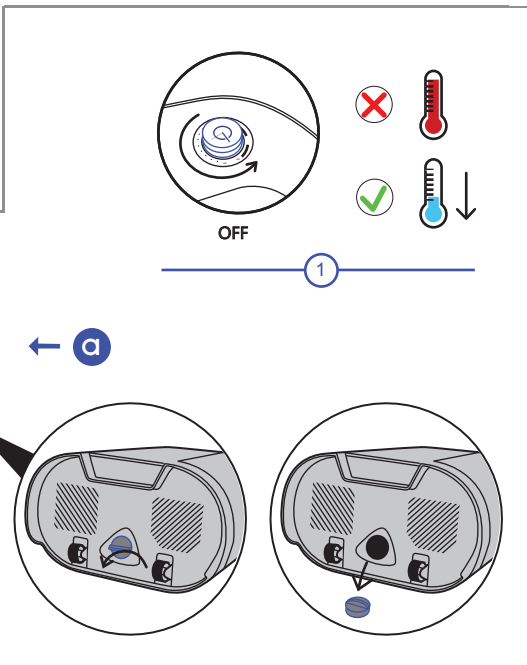
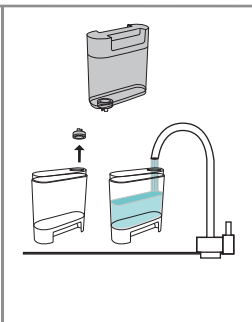
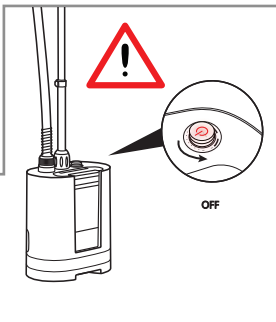

SteamOne

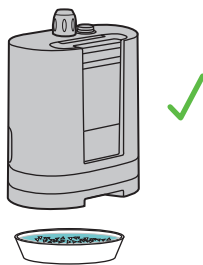
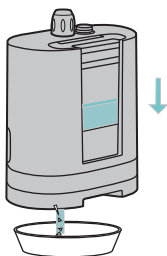
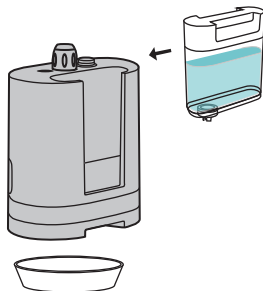
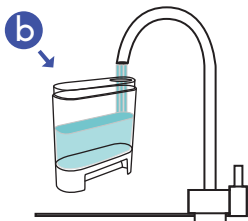

SteamOne