

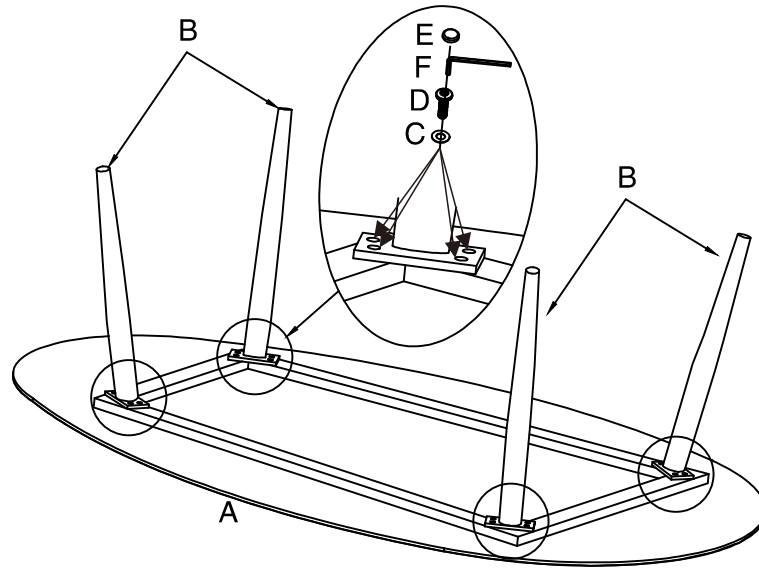

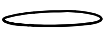



Assembly Instruction



Part List

NO.	Picture	Name	Qty
A		Table Rim	1
B		Table Leg	4
C		Washer	16
D		Bolt M6x15	16
E		Bolt Cover	16
F		Wrench	1

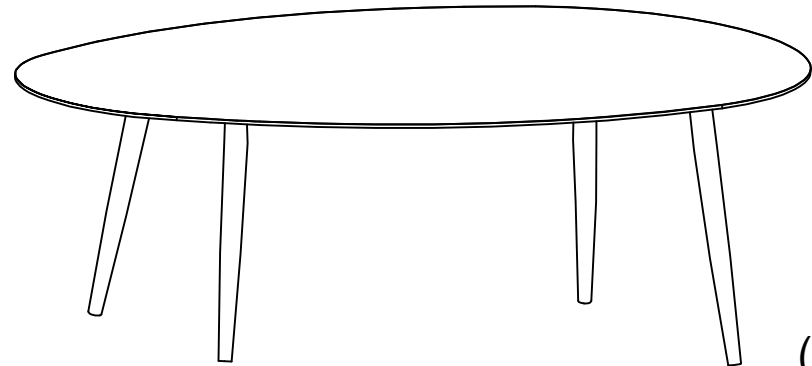

(41398)