



FRESH 'N REBEL

CODE ANC
USER MANUAL

PRODUCT NUMBER:
3HP3000 v1 001

Hereby, Sitecom declares that this radio equipment is in compliance with Directive 2014/53/EU.
The full text of the EU declaration of conformity is available at the following internet address: www.freshnrebel.com
Operating frequency band: 2400 to 2483.5 MHz. Maximum radio-frequency power transmitted: 4.07 dBm / 2.55 mW

Sitecom verklaart hierbij dat dit radioapparaat voldoet aan de richtlijn 2014/53/EU.
De volledige tekst van de EG-verklaring van overeenstemming is beschikbaar op: www.freshnrebel.com
Gebruikte frequentieband: 2400 tot 2483.5 MHz. Maximaal uitgezonden radiofrequentievermogen: 4.07 dBm / 2.55 mW

Hiermit erklärt Sitecom, dass der Funkanlagentyp der Richtlinie 2014/53/EU entspricht.
Der vollständige Text der EU-Konformitätserklärung ist unter der folgenden Internetadresse verfügbar: www.freshnrebel.com
Betriebsfrequenzband: 2400 bis 2483.5 MHz. Maximale übertragene HF-Leistung: 4.07 dBm / 2.55 mW

Sitecom dichiara che questa apparecchiatura radio è conforme alla Direttiva 2014/53/UE.
Il testo completo della dichiarazione di conformità UE è disponibile al seguente indirizzo Internet: www.freshnrebel.com
Banda di frequenza di funzionamento: da 2400 a 2483.5 MHz. Potenza massima delle frequenze radio trasmesse: 4.07 dBm / 2.55 mW

Por la presente, Sitecom declara que este equipo de radio cumple con la normativa europea 2014/53/EU.
El texto completo de la declaración UE de conformidad está disponible en la siguiente dirección de internet: www.freshnrebel.com
Banda de frecuencia de funcionamiento: 2400 a 2483.5 MHz. Potencia de radiofrecuencia máxima transmitida: 4.07 dBm / 2.55 mW

A Sitecom vem por este meio declarar que este equipamento de rádio cumpre o disposto na Diretiva 2014/53/UE.
A versão integral da declaração de conformidade da UE está disponível na internet no seguinte endereço: www.freshnrebel.com
Banda de frequência de funcionamento: 2400 a 2483.5 MHz. Potência de radiofrequência máxima transmitida: 4.07 dBm / 2.55 mW

Sitecom déclare par la présente que cet équipement radioélectrique est en conformité avec la Directive 2014/53/UE.
Le texte intégral de la déclaration de conformité de l'UE est disponible à l'adresse internet suivante : www.freshnrebel.com
Bande de fréquences opérationnelle : 2400 à 2483.5 MHz. Puissance fréquence radio maximale transmise : 4.07 dBm / 2.55 mW

Firma Sitecom niniejszym oświadcza, że urządzenie radiowe spełnia wymagania dyrektywy 2014/53/UE.
Pełny tekst deklaracji zgodności UE dostępny jest pod adresem internetowym: www.freshnrebel.com
Pasmo częstotliwości pracy: 2400 do 2483.5 MHz. Maksymalna moc nadawanego sygnału radiowego: 4.07 dBm / 2.55 mW

Prin prezenta, Sitecom declară că acest echipament radio este în conformitate cu prevederile Directivei 53/2014 UE.
Textul complet al declarației de conformitate UE este disponibil la următoarea adresă de internet: www.freshnrebel.com
Bandă de frecvență de funcționare: 2400 - 2483.5 MHz. Putere maximă de frecvență radio transmisă: 4.07 dBm / 2.55 mW

Με το παρόν, η Sitecom δηλώνει ότι αυτός ο ραδιοεξοπλισμός συμμορφώνεται με την Οδηγία 2014/53/Ε.
Το πλήρες κείμενο της δήλωσης συμμόρφωσης για την ΕΕ διατίθεται στην ακόλουθη διεύθυνση Internet: www.freshnrebel.com
Ζώνη συχνοτήτων λειτουργίας: 2400 έως 2483.5 MHz. Μέγιστη ισχύς μετάδοσης ραδιοσυχνότητας: 4.07 dBm / 2.55 mW

Sitecom настоящим заявляет, что этот продукт соответствует Директиве 2014/53 / EU.
Полный текст декларации о соответствии ЕС доступен по следующему интернет-адресу: www.freshnrebel.com
Диапазон рабочих частот: от 2400 до 2483,5 МГц. Максимальная передаваемая мощность радиочастоты: 4,07 дБм / 2,55 мВт

BUTTONS

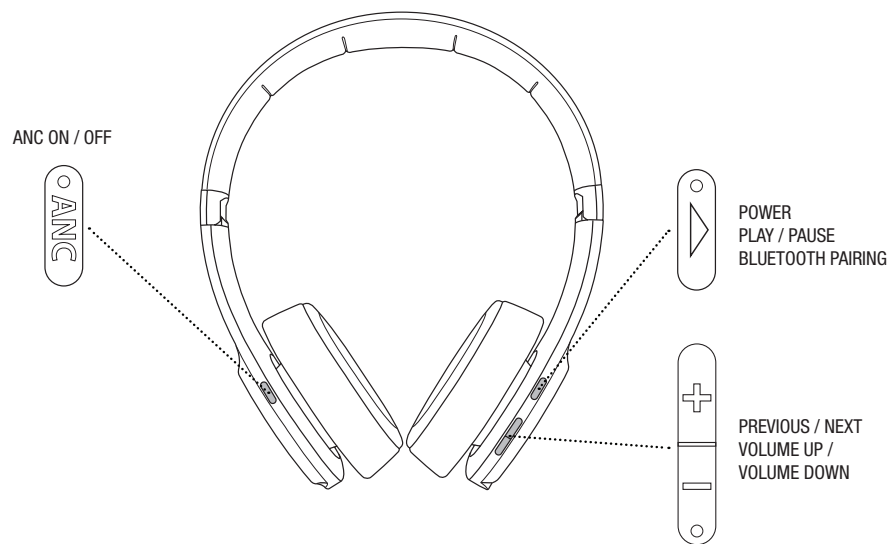

LEDS

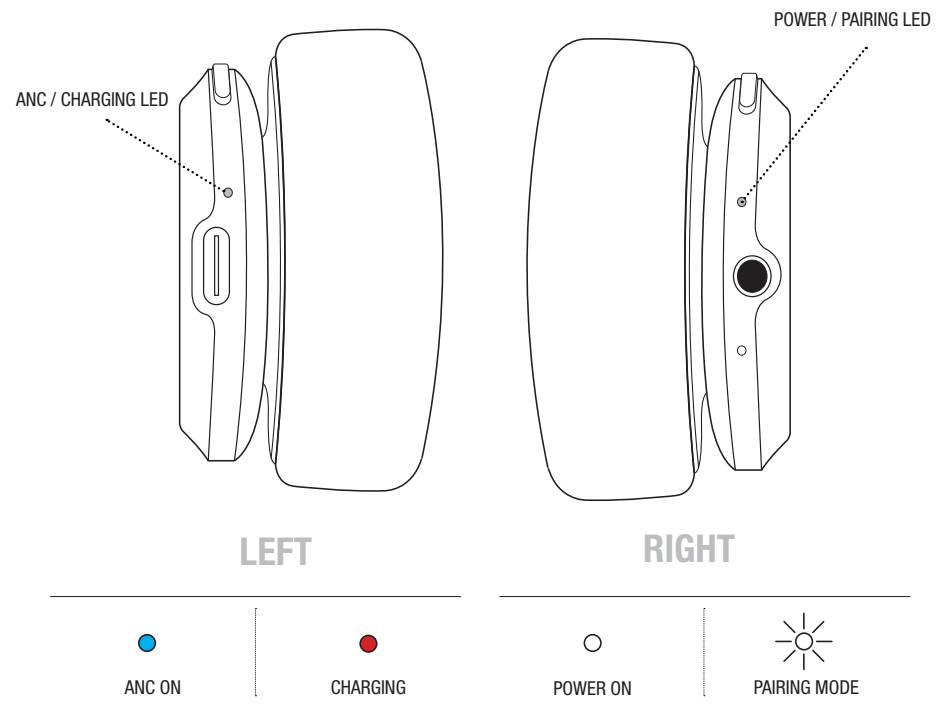

GETTING STARTED

1.

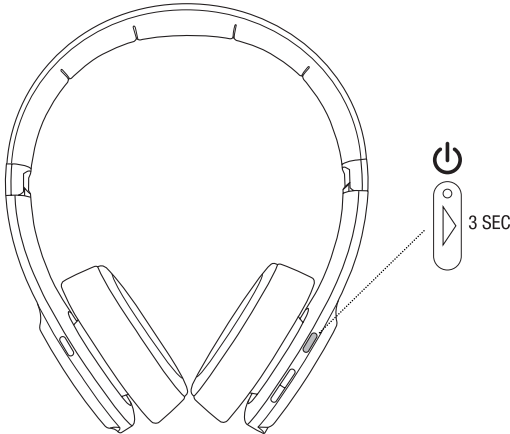

3.

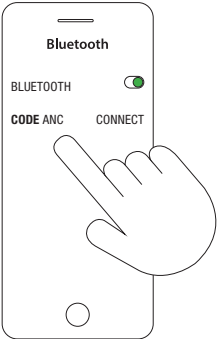

2.

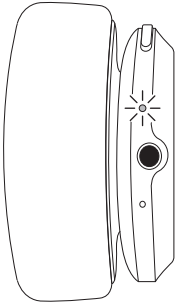

4.



OPERATION

GENERAL USE - OPERATING ANC

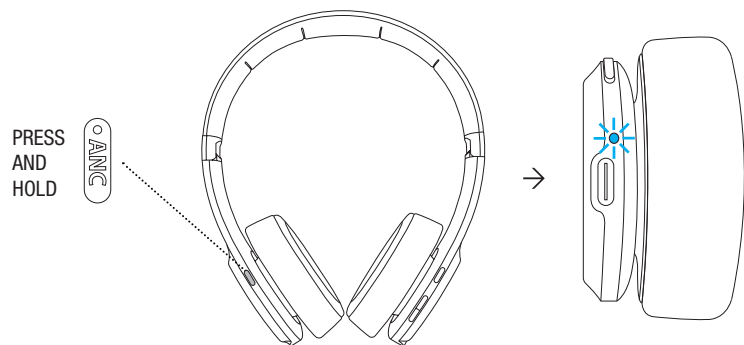

POWER ON / OFF

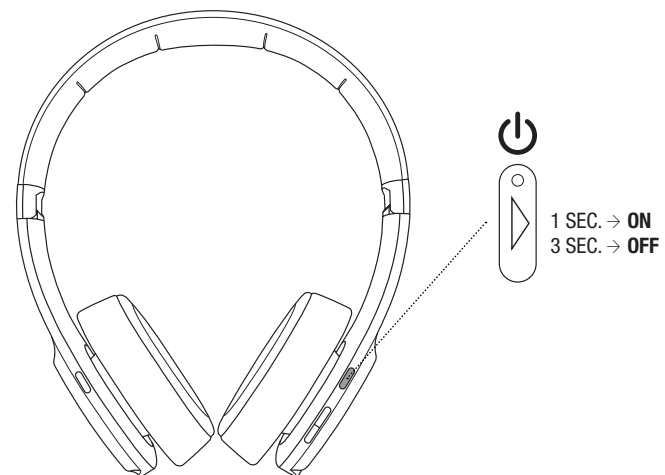

MUSIC AND PHONE CALLS

PLAYING MUSIC

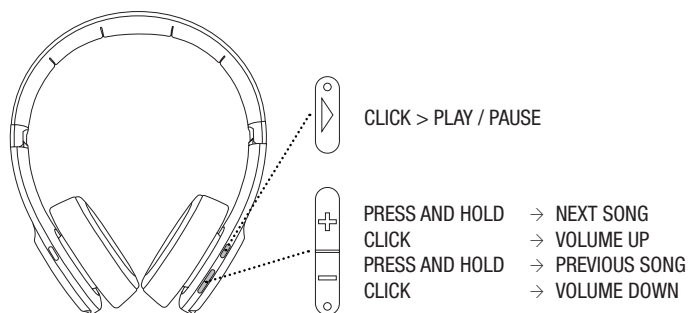

INCOMING CALL

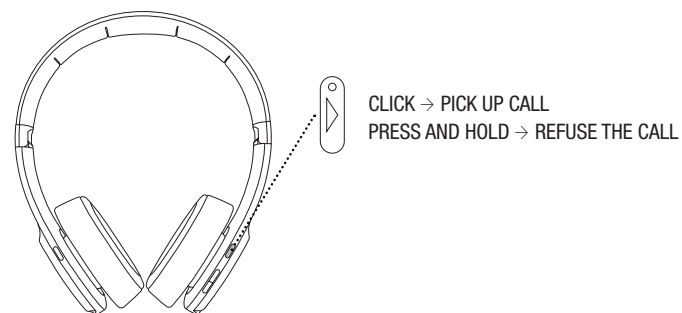

DURING A CALL

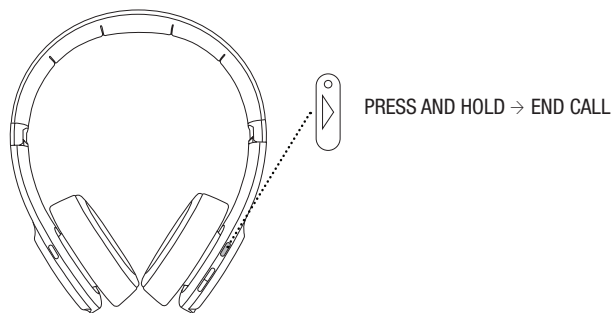

VOICE ASSISTANT

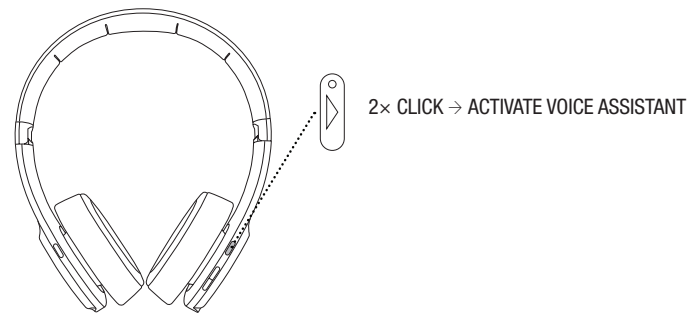

KNOPPEN

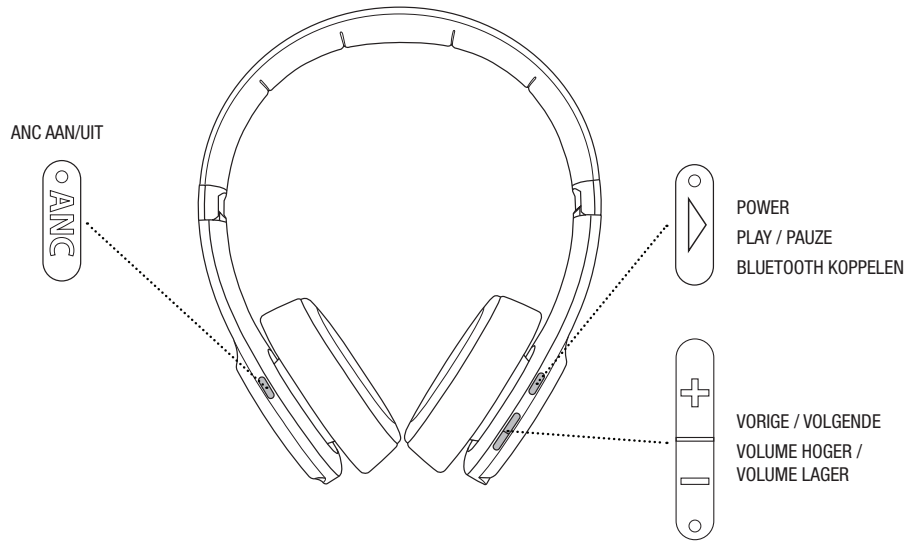

LEDS

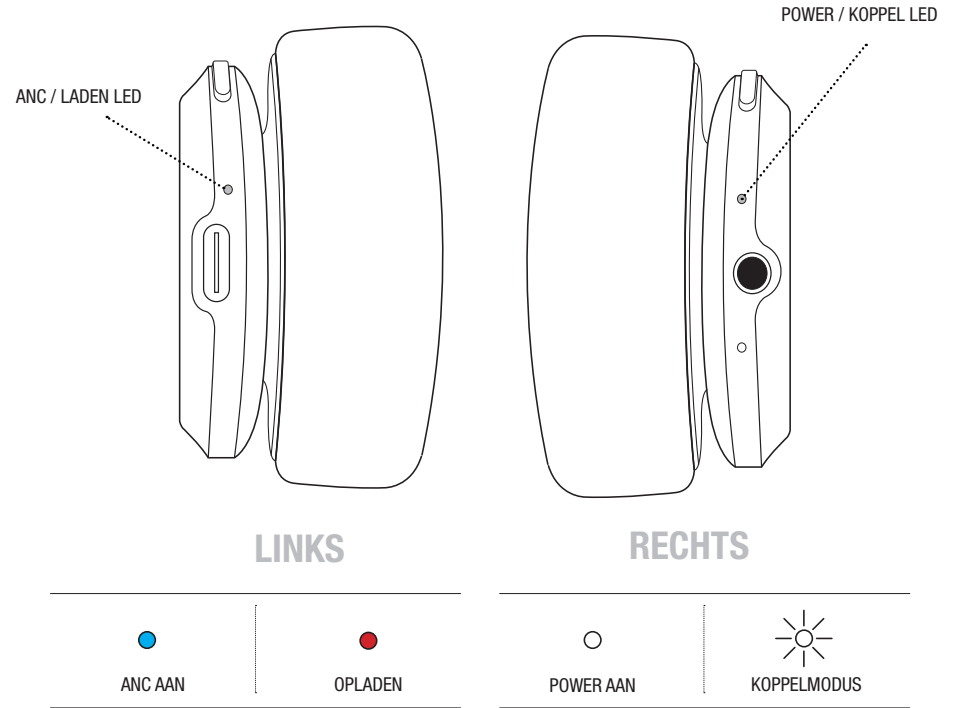

AAN DE SLAG

1.

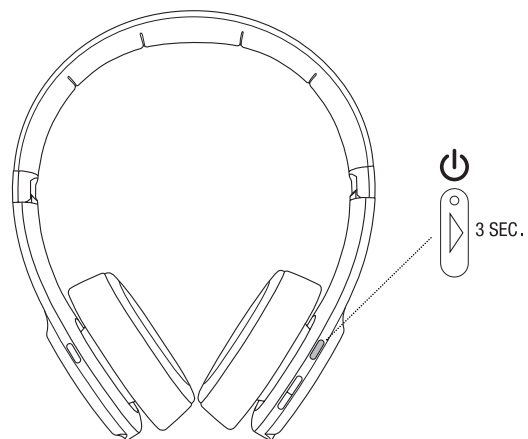

3.

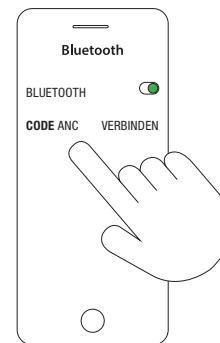

2.

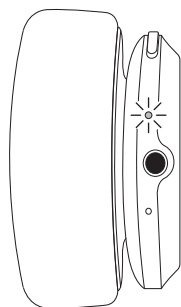

4.



GEBRUIK

ALGEMEEN GEBRUIK – ANC BEDIENEN



POWER AAN / UIT

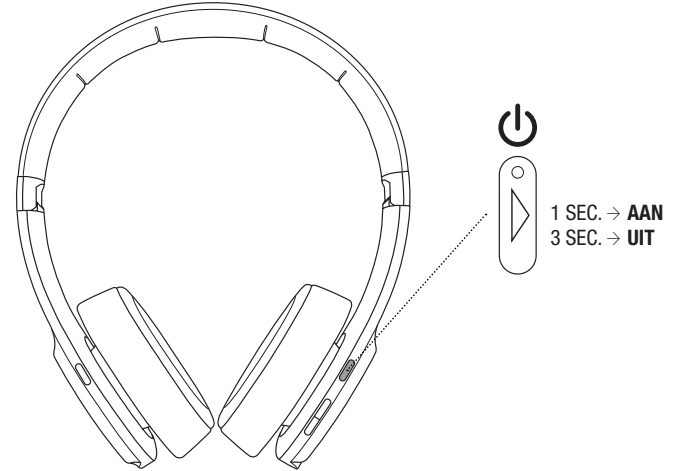

MUZIEK EN TELEFOONGESPREKKEN

MUZIEK AF SPELEN

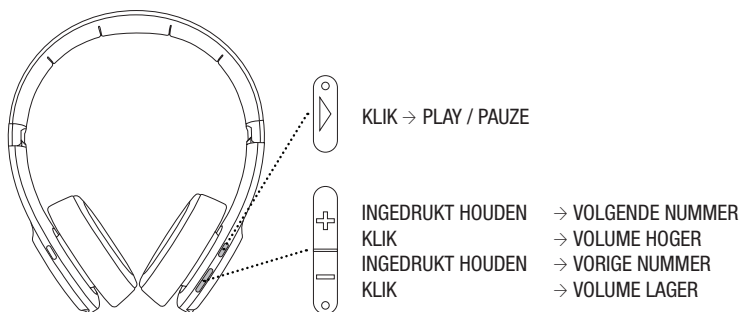

INKOMENDE OPROEP

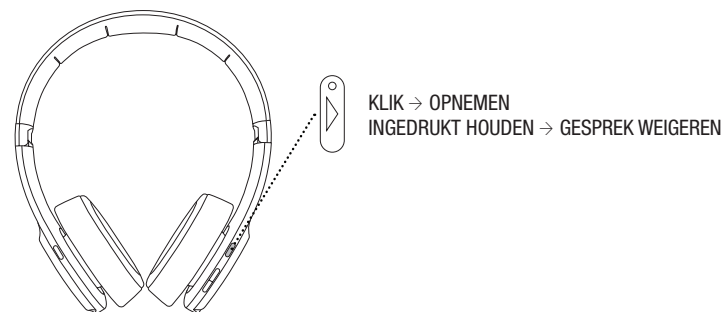

TIJDENS HET BELLEN

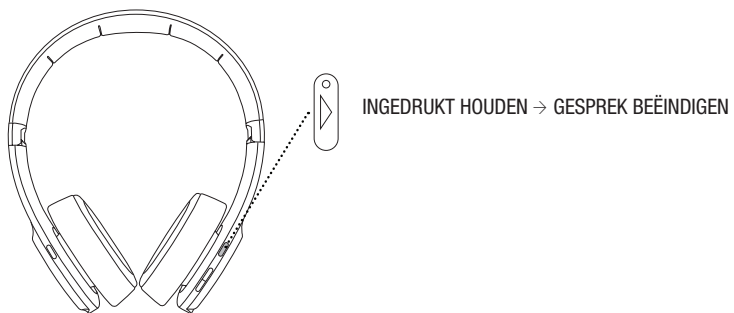

SPRAAKASSISTENT

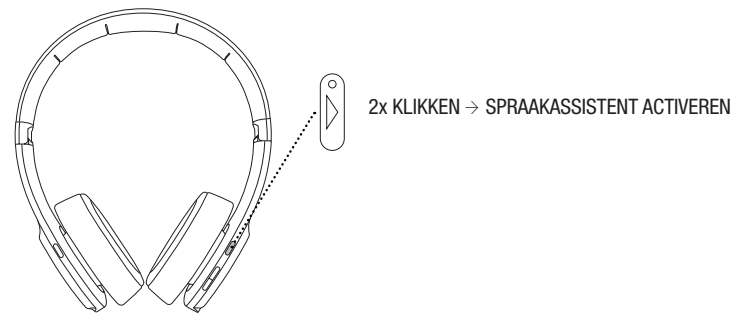

TASTEN

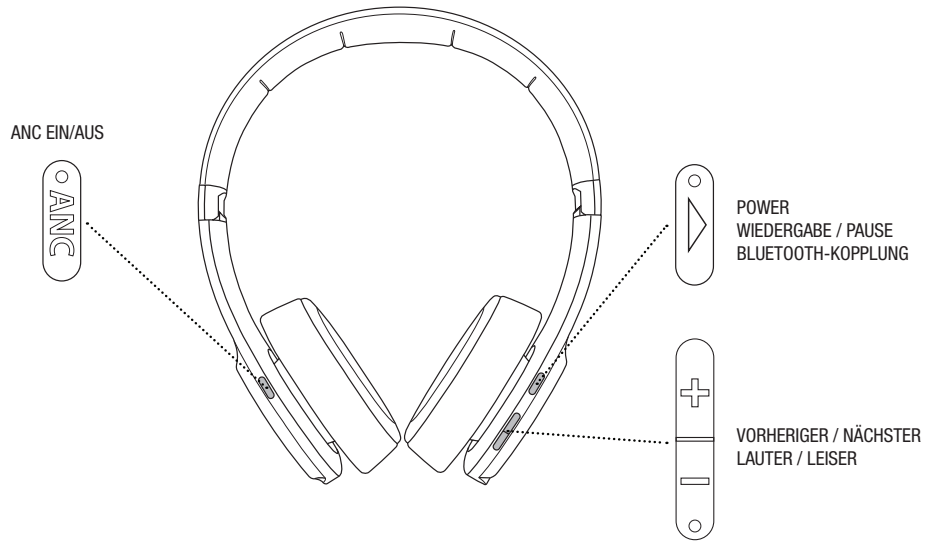

LEDS

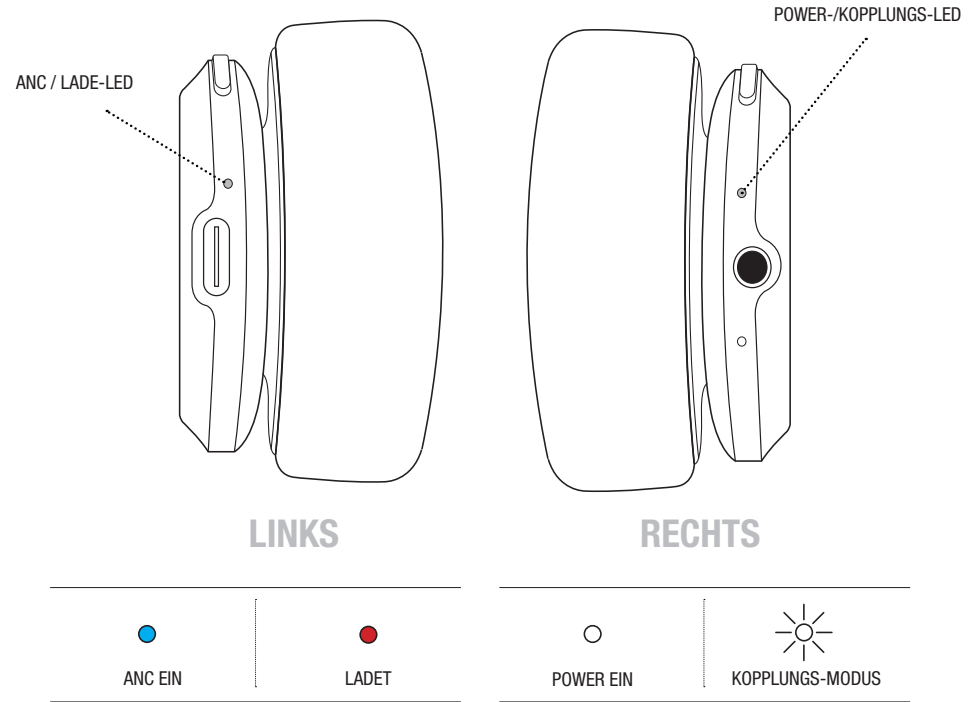

ERSTE SCHRITTE

1.

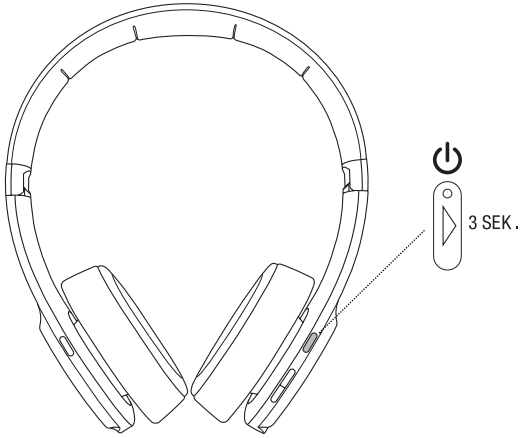

3.

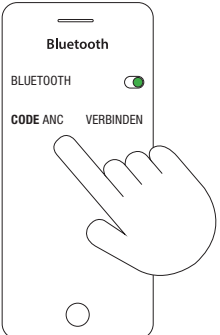

2.

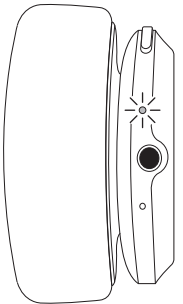

4.



BETRIEB

ALLGEMEINE VERWENDUNG - ANC-BETRIEB



POWER EIN / AUS



MUSIK UND ANRUF

MUSIKWIEDERGABE

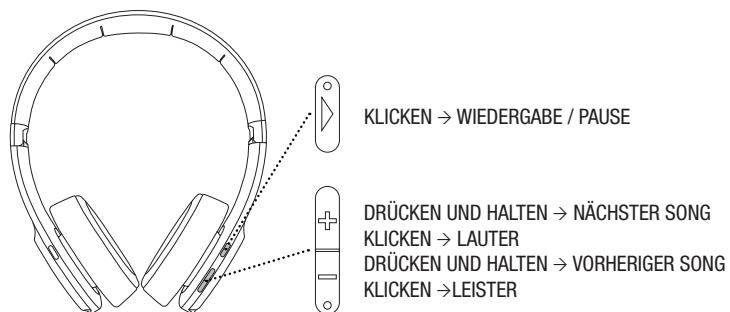

EINGEHENDER ANRUF

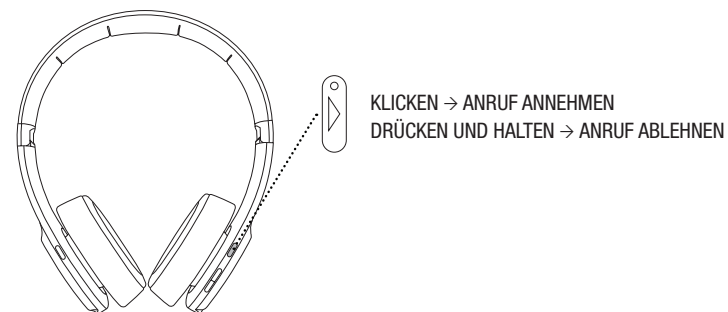

WÄHREND EINES ANRUF

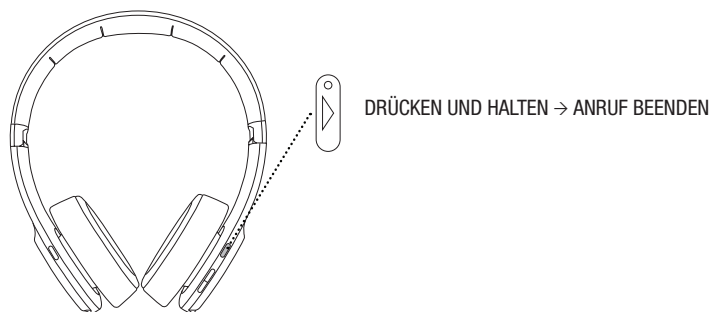

SPRACHASSISTENT

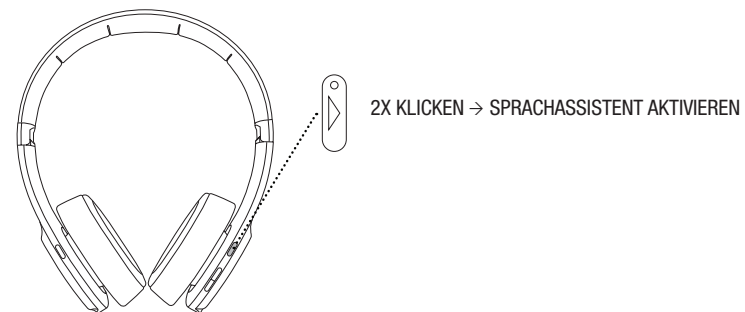

PULSANTI

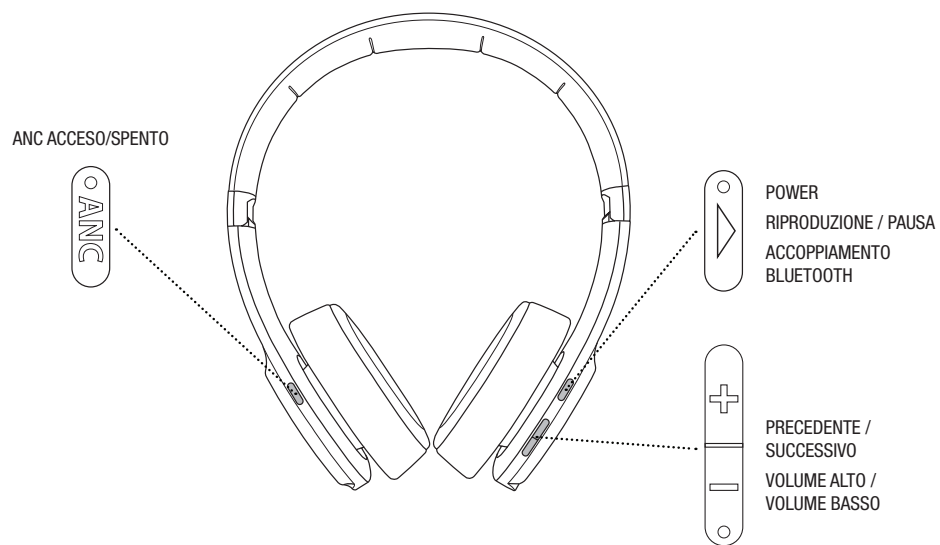

LEDS

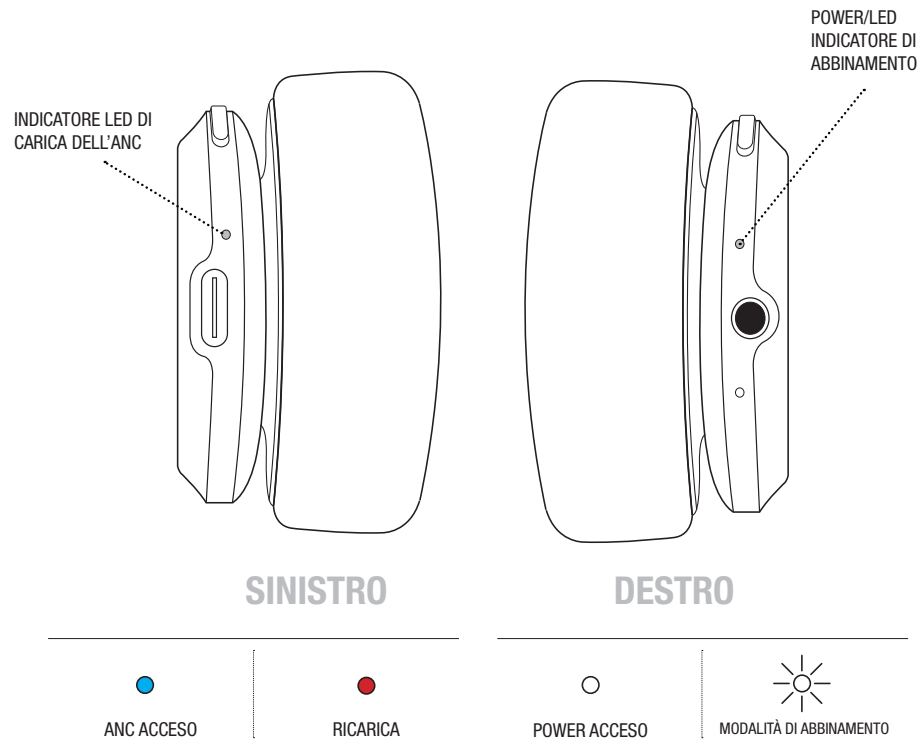

INIZIO

1.

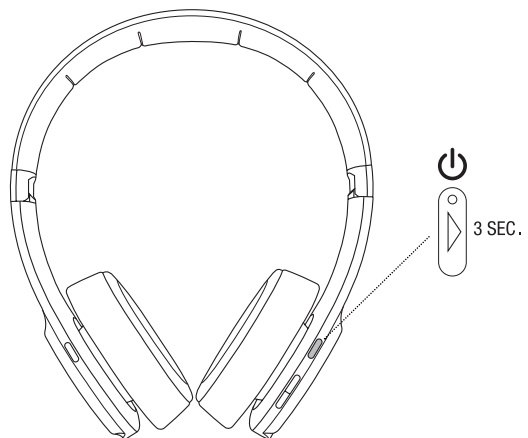

3.

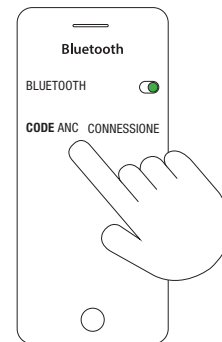

2.

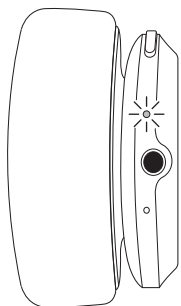

4.



FUNZIONAMENTO

USO GENERALE - FUNZIONAMENTO ANC

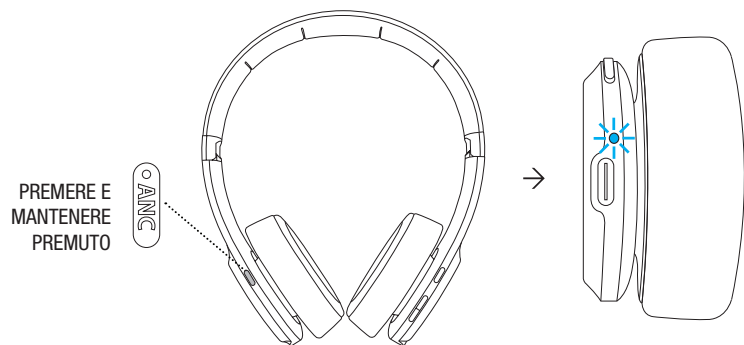

POWER ACCESO/SPENTO

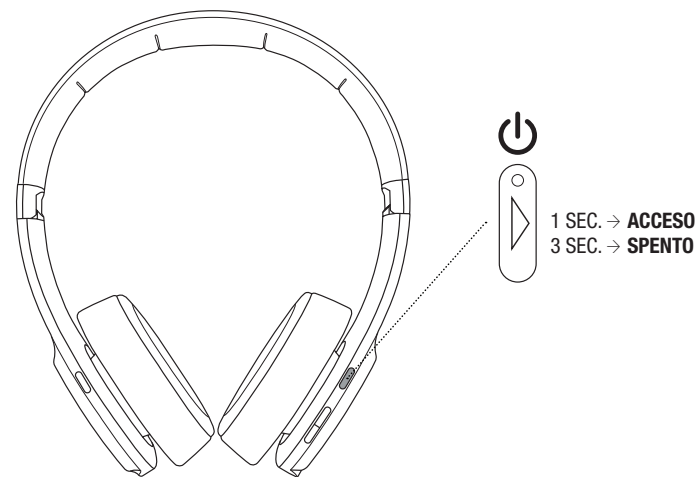

MUSICA E CHIAMATE TELEFONICHE

RIPRODUZIONE MUSICALE

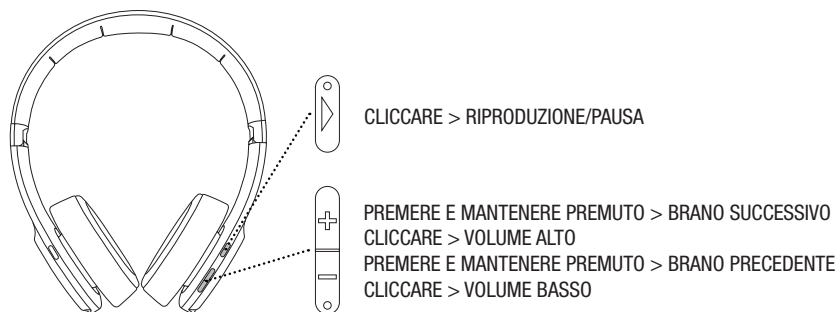

CHIAMATA ENTRANTE

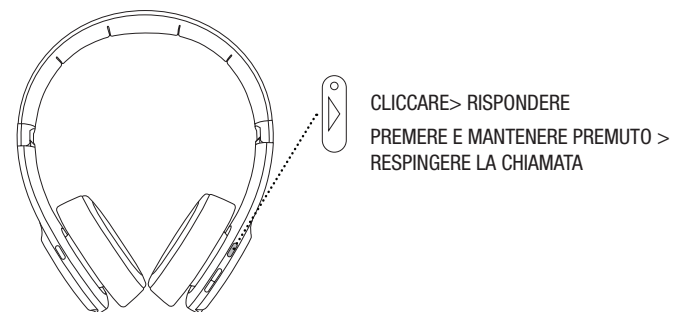

DURANTE UNA CONVERSAZIONE TELEFONICA

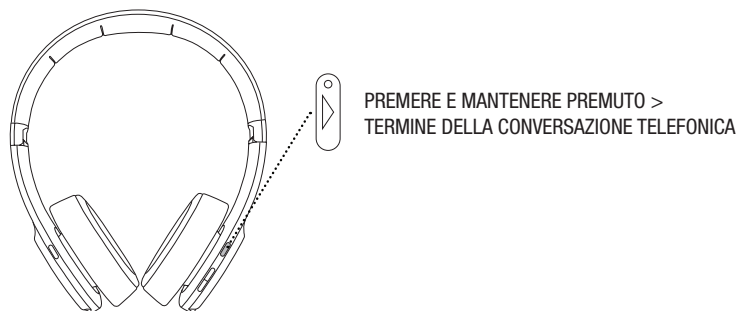

ASSISTENTE VOCALE



BOTONES

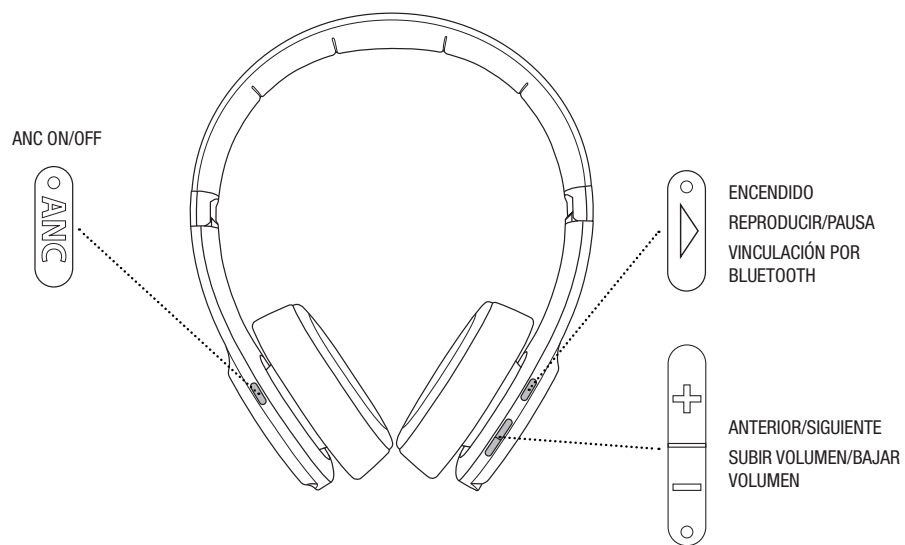

LEDS

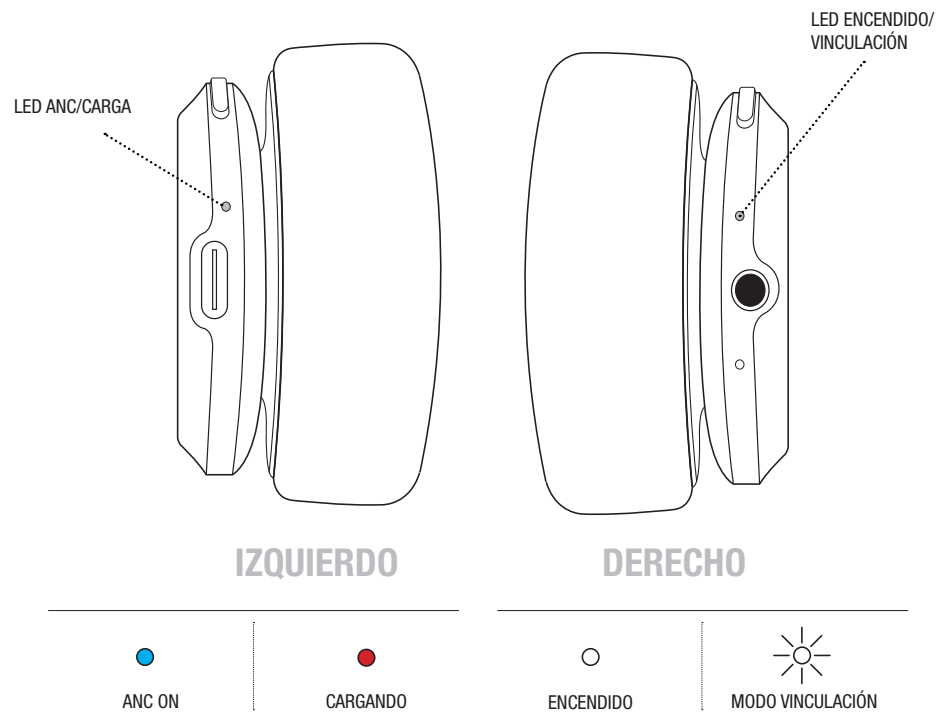

EMPEZANDO

1.

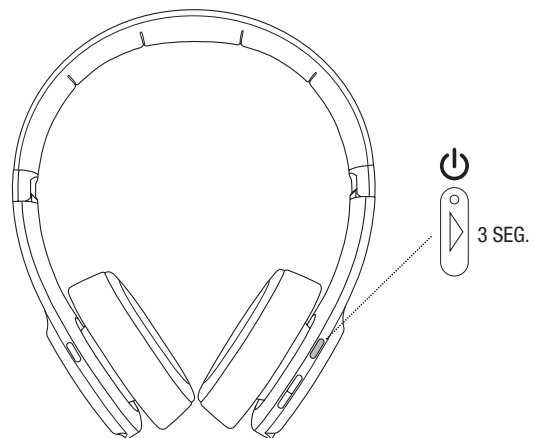

3.

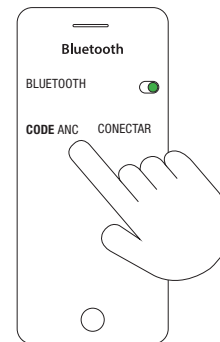

2.

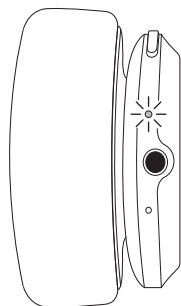

4.



FUNCIONAMIENTO

USO GENERAL: FUNCIONAMIENTO DE ANC

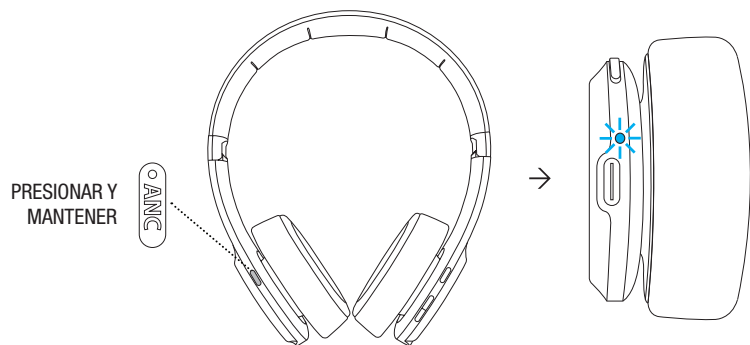

ENCENDIDO/APAGADO

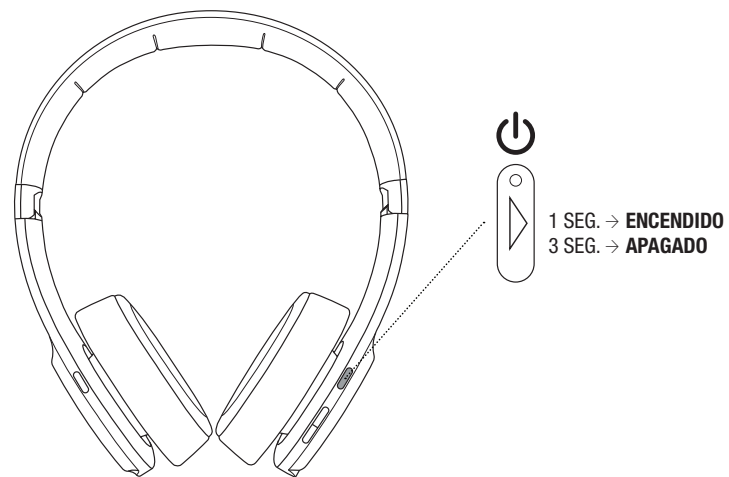

MÚSICA Y LLAMADAS DE TELÉFONO

REPRODUCIENDO MÚSICA

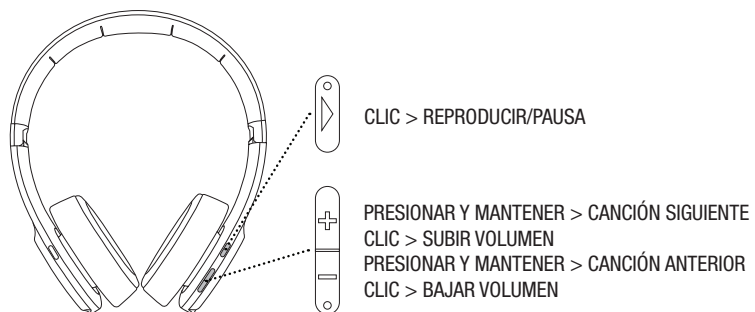

LLAMADA ENTRANTE

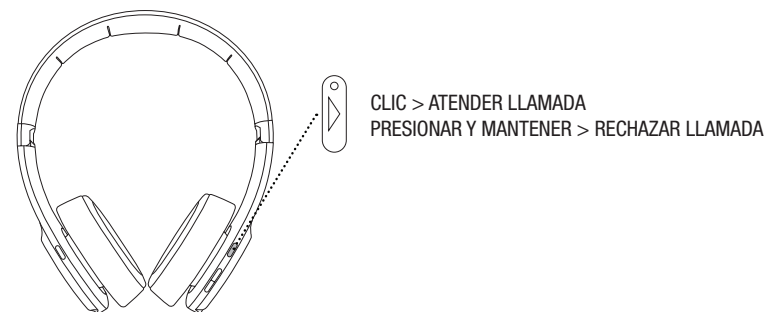

DURANTE UNA LLAMADA

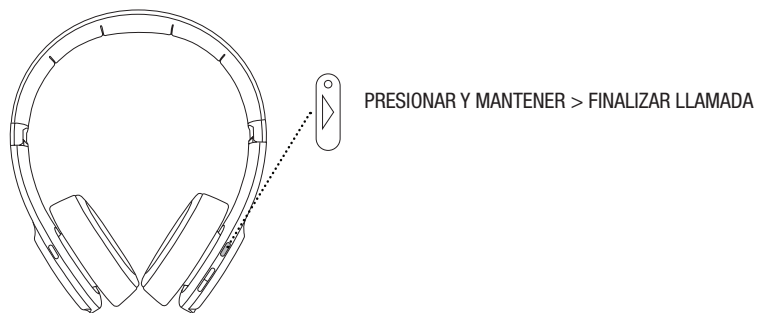

ASISTENTE DE VOZ

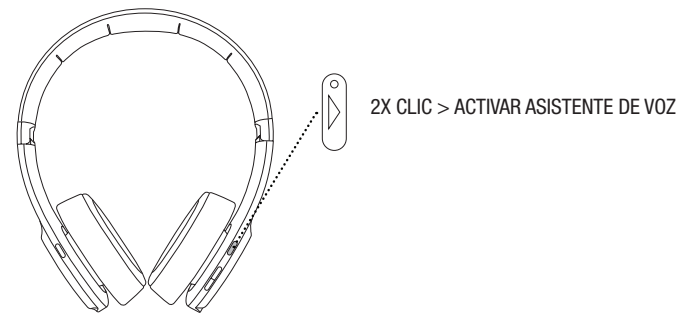

BOTÕES

ANC
LIGADO/DESLIGADO

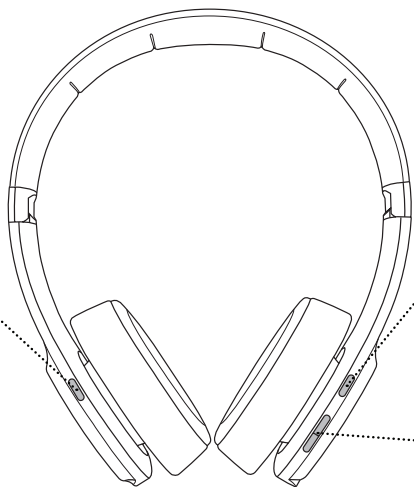

LIGAR / DESLIGAR
EXECUTAR / PAUSA
EMPARELHAMENTO /
BLUETOOTH



ANTERIOR / SEGUINTE
AUMENTAR VOLUME /
DIMINUIR VOLUME

LEDS

ANC / LED DE
CARREGAMENTO

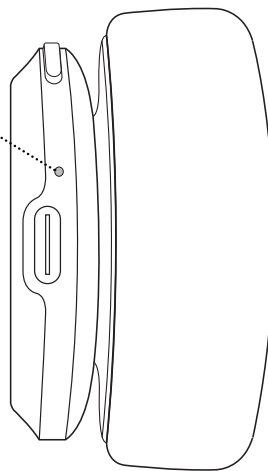

ESQUERDA



ANC LIGADO



CARREGAMENTO

LIGAR-DESLIGAR /
EMPARELHAMENTO
LED

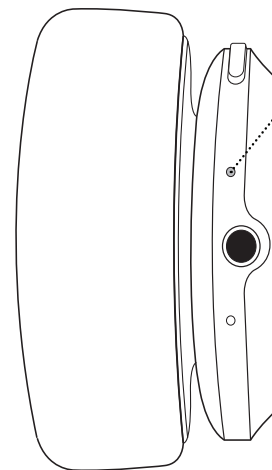

DIREITA



LIGAR



MODO DE EMPARELHAMENTO

INÍCIO

1.

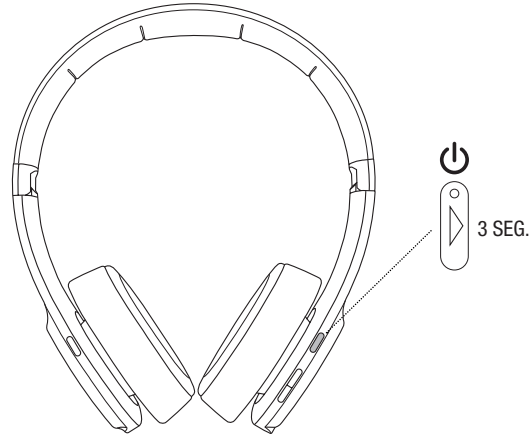

3.

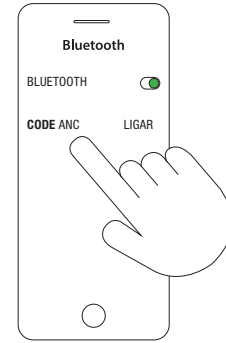

2.

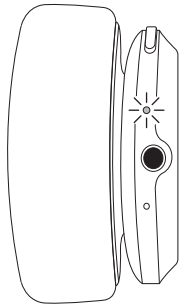

4.



OPERAÇÃO

USO GERAL - FUNCIONAMENTO ANC

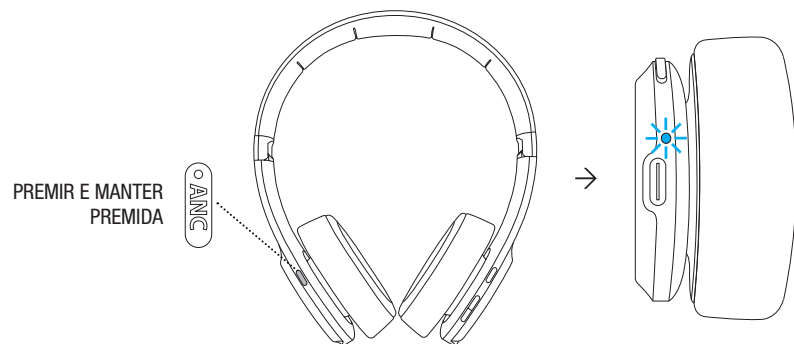

LIGAR / DESLIGAR



MÚSICA E CHAMADAS TELEFÓNICAS

REPRODUZIR MÚSICA

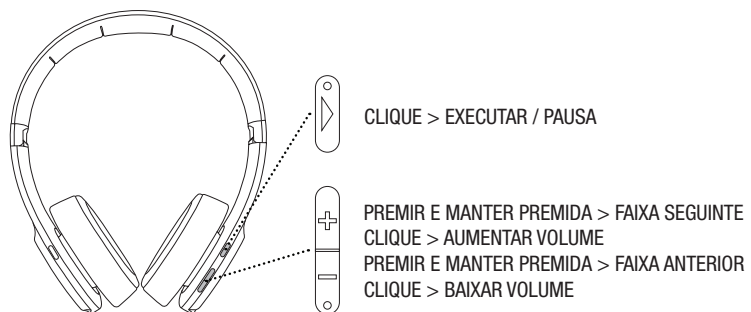

CHAMADA RECEBIDA

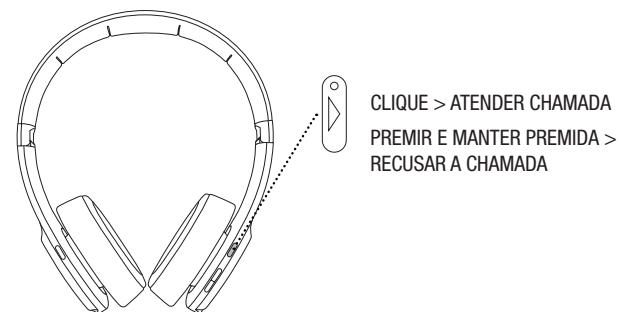

DURANTE UMA CHAMADA

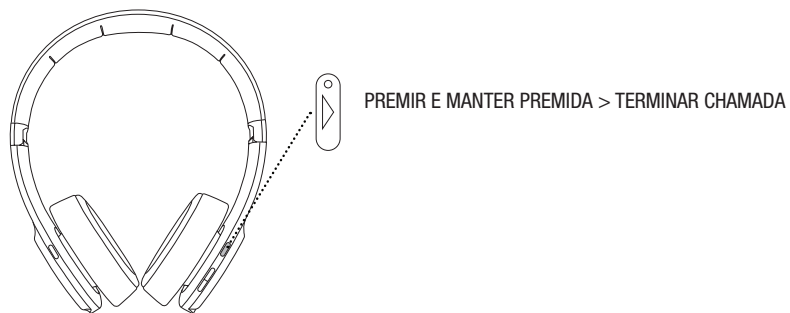

ASSISTENTE DE VOZ

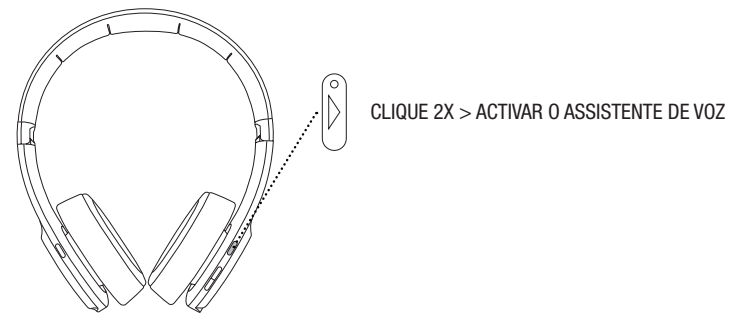

LES TOUCHES



LES VOYANTS

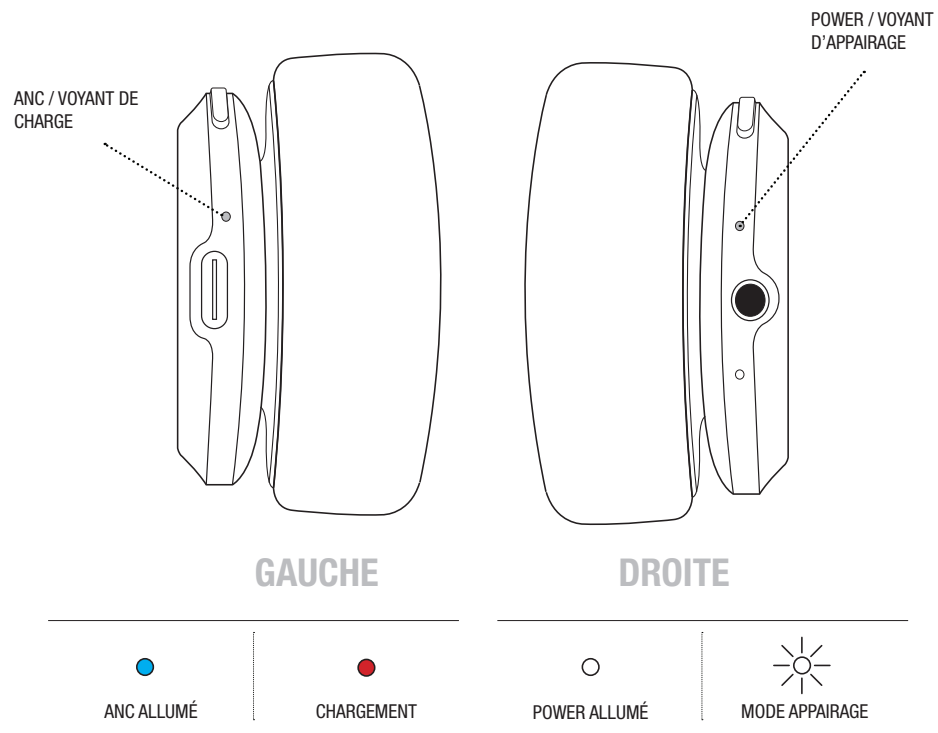

COMMENCEMENT

1.

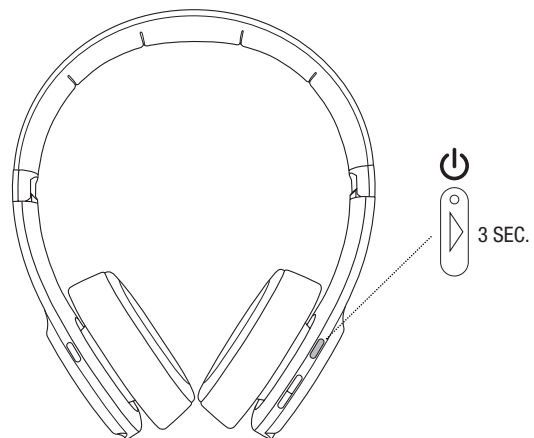

3.

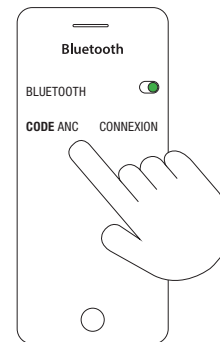

2.

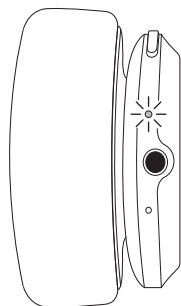

4.

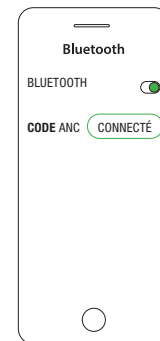

FONCTIONNEMENT

UTILISATION GÉNÉRALE - FONCTIONNEMENT DE L'ANC

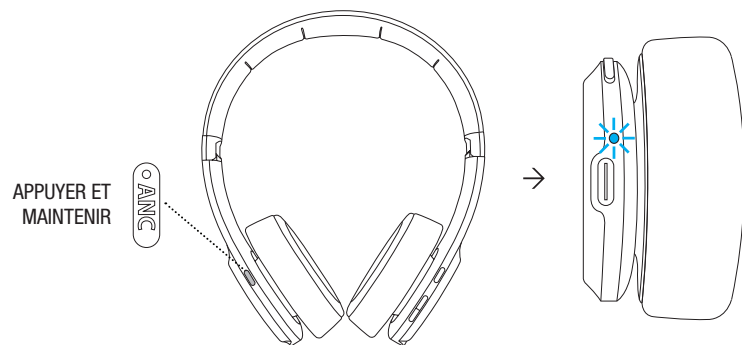

MISE EN MARCHÉ / ARRÊT

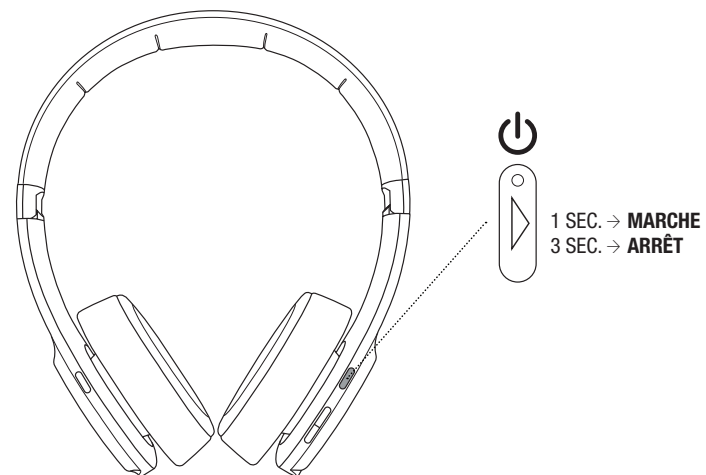

MUSIQUE ET APPELS TÉLÉPHONIQUES

JOUER DE LA MUSIQUE

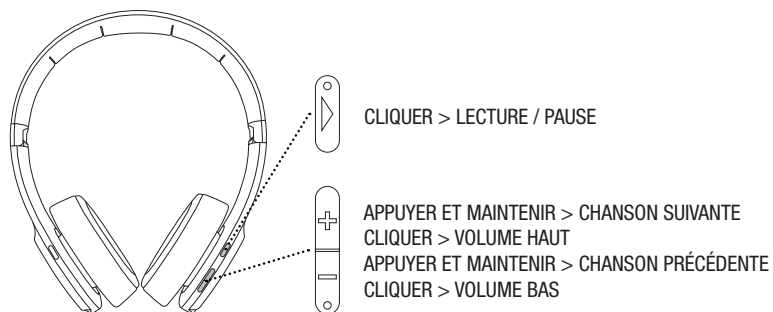

APPEL ENTRANT

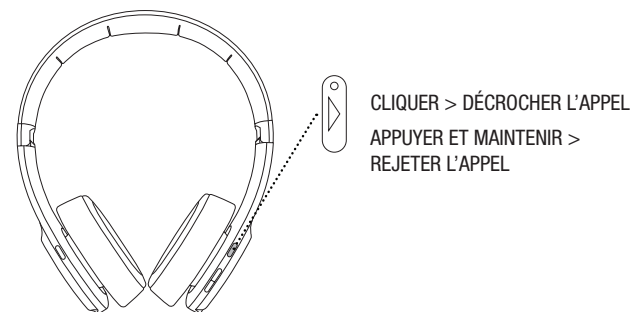

PENDANT UN APPEL

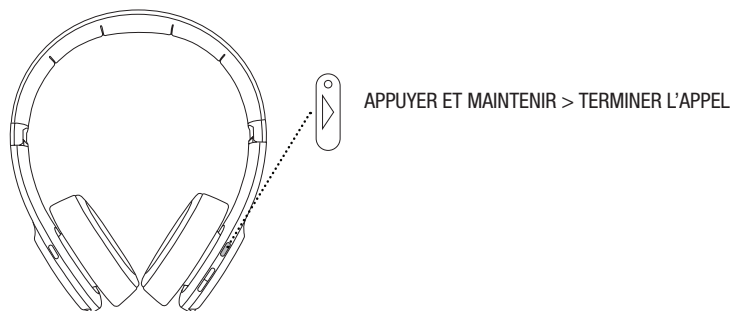

ASSISTANT VOCAL

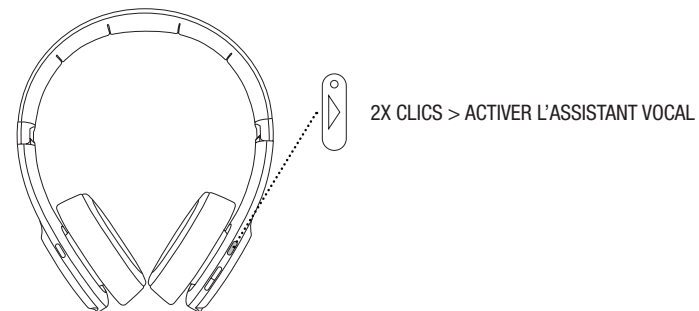

PRZYCISKI

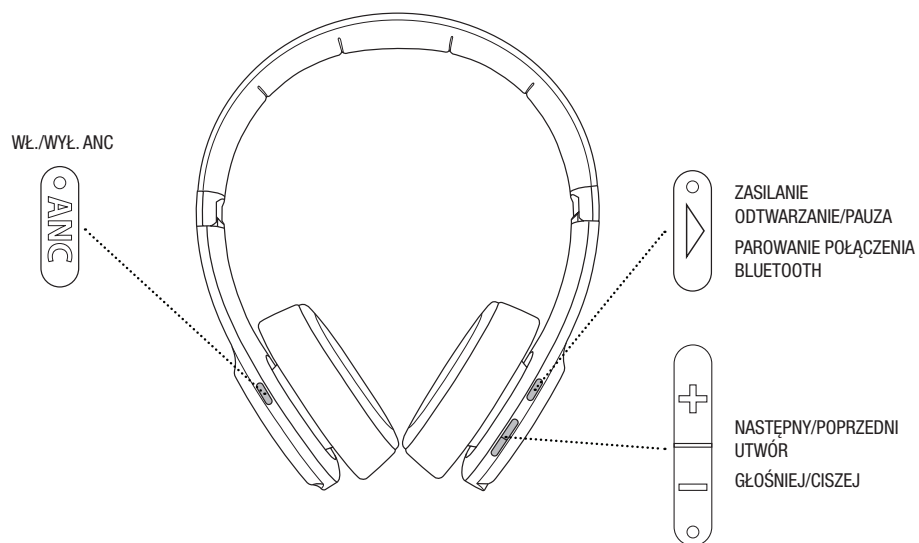

DIODY LED

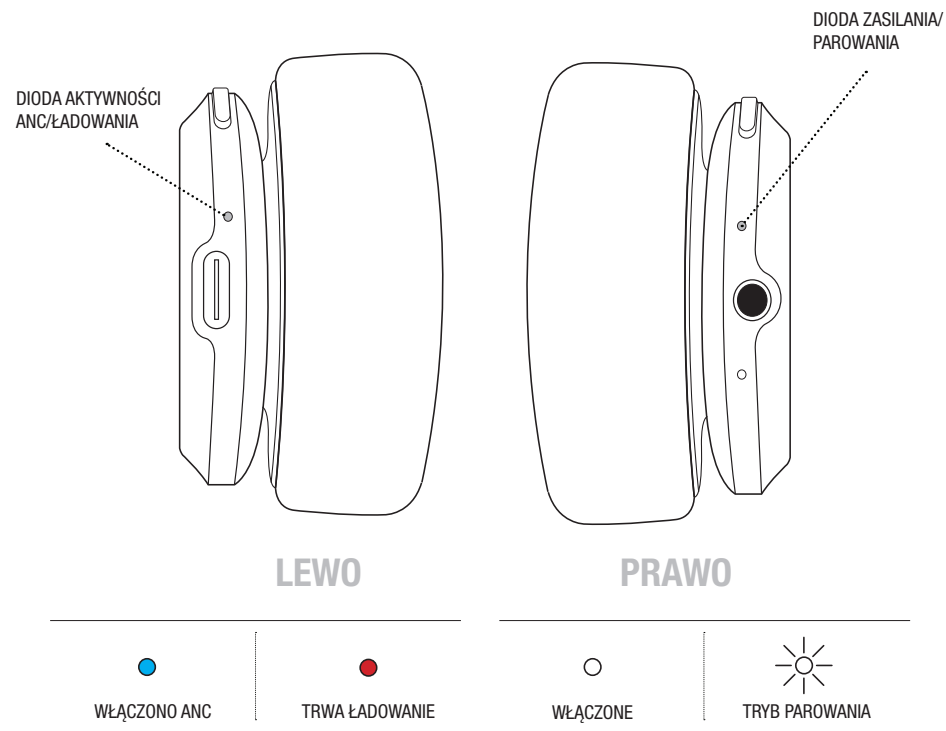

URUCHAMIANIE URZĄDZENIA

1.

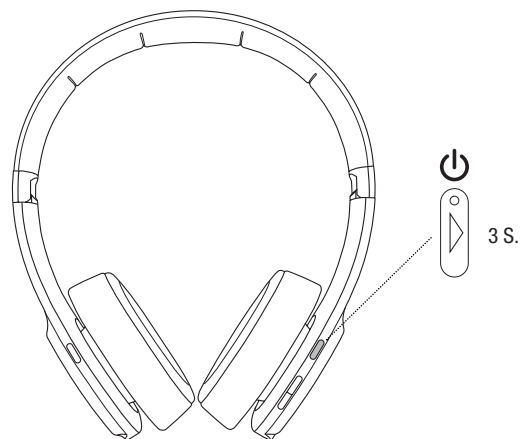

3.

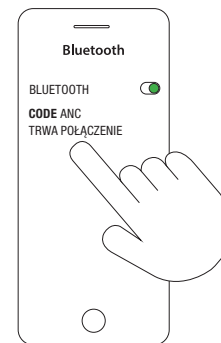

2.

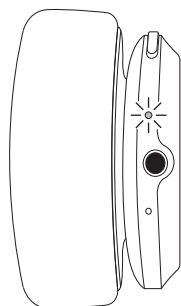

4.



OBSŁUGA URZĄDZENIA

OGÓLNE – OBSŁUGA ANC

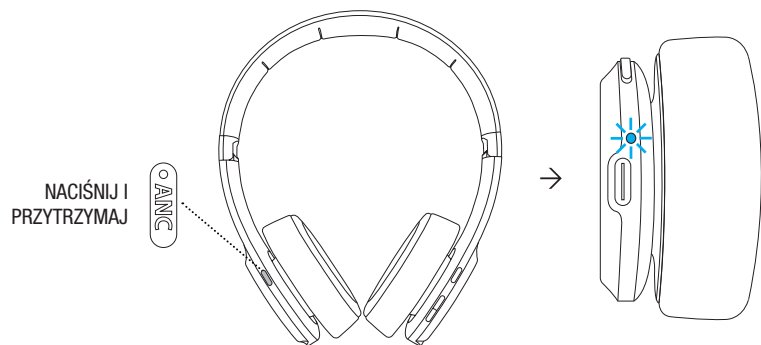

WŁĄCZANIE/WYŁĄCZANIE URZĄDZENIA

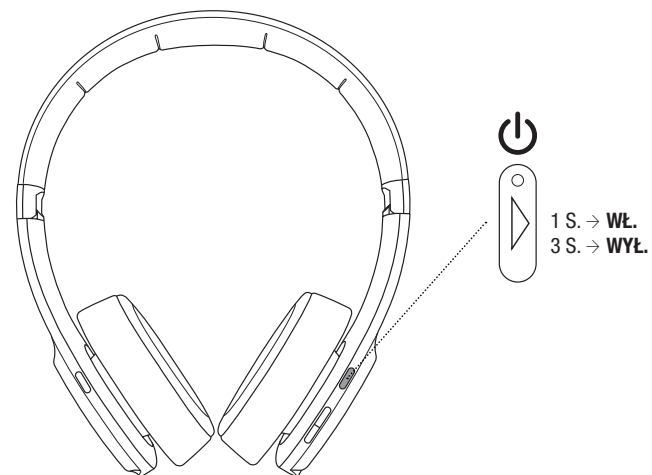

MUZYKA I POŁĄCZENIA TELEFONICZNE

ODTWARZANIE MUZYKI

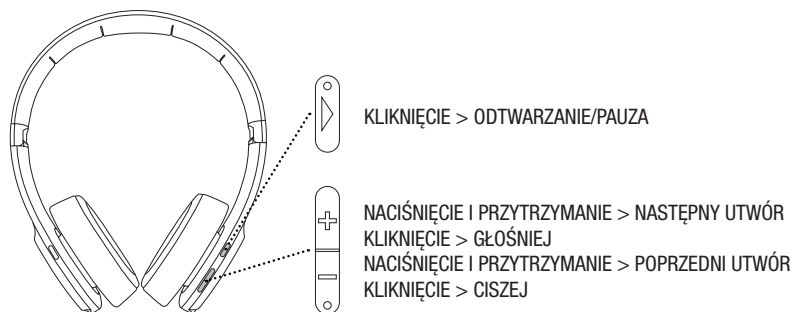

POŁĄCZENIE PRZYCHODZĄCE

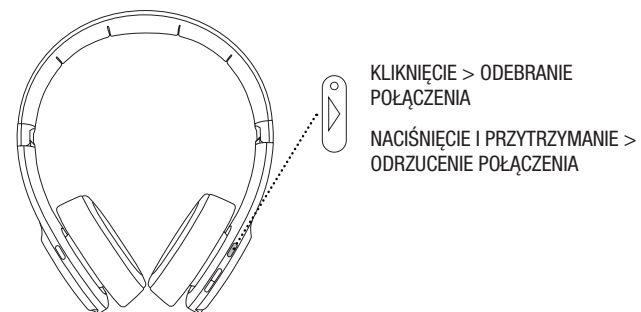

W TRAKCIE POŁĄCZENIA



ASYSTENT GŁOSOWY



BUTOANE



LEDURI

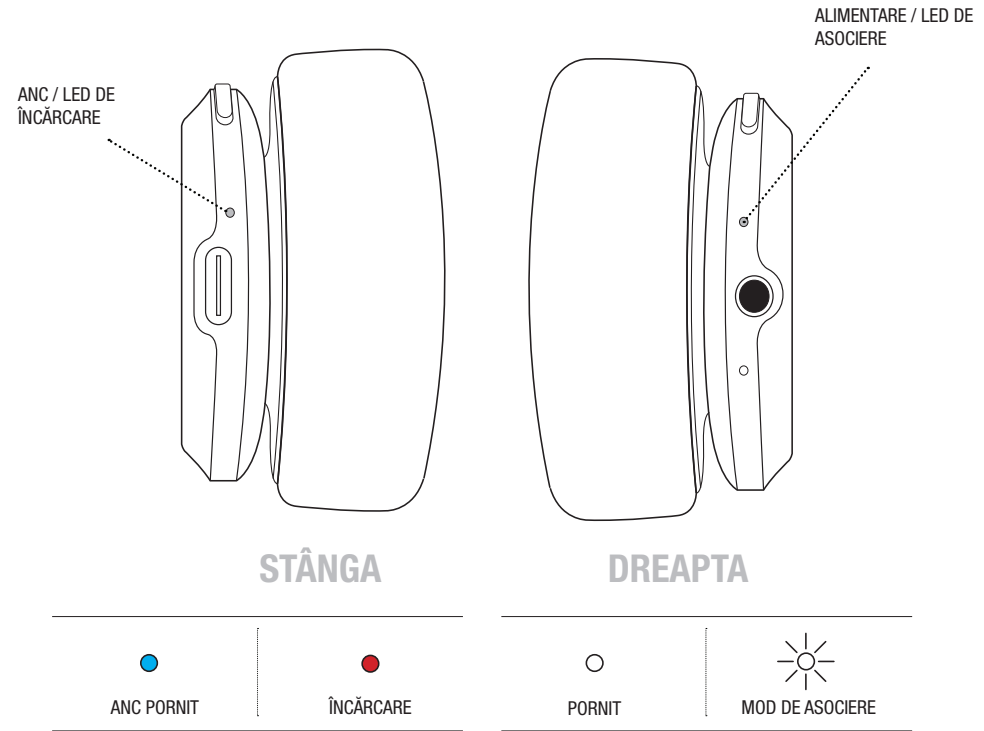

INIȚIERE

1.

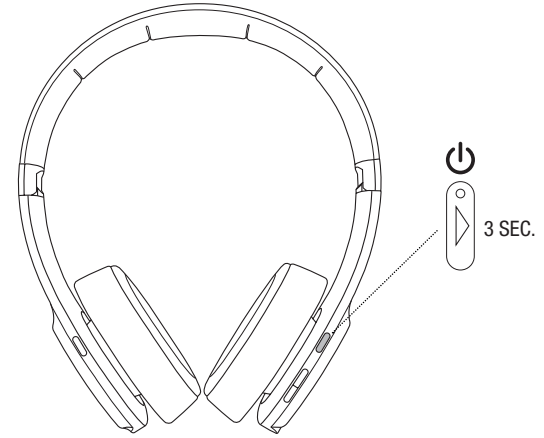

3.

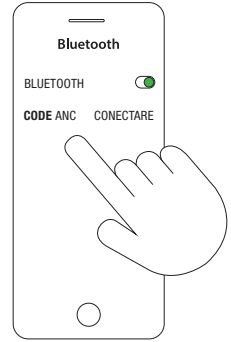

2.

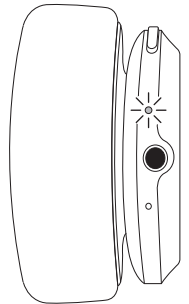

4.



OPERARE

UTILIZARE GENERALĂ - FUNCȚIONAREA ANC



PORNIT / OPRIT

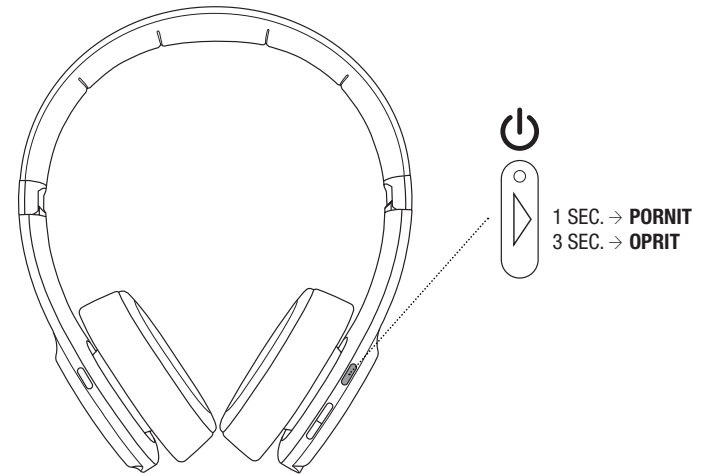

MUZICĂ ȘI APELURI TELEFONICE

REDAREA MUZICII

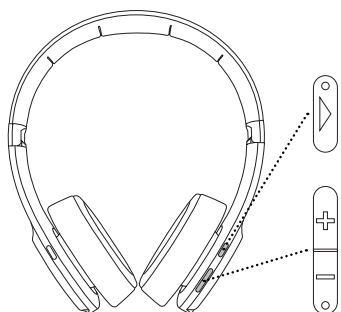

FACEȚI CLIC PE > REDARE / PAUZĂ

APĂSAȚI ȘI ȚINEȚI APĂSAT PE > MELODIA URMĂTOARE
FACEȚI CLIC PE > CREȘTEREA VOLUMULUI
APĂSAȚI ȘI ȚINEȚI APĂSAT PE > MELODIA ANTERIOARĂ
FACEȚI CLIC PE > SCĂDEREA VOLUMULUI

APEL PRIMIT

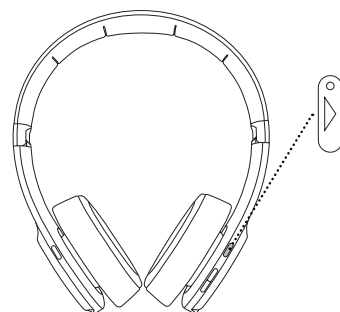

FACEȚI CLIC PE > PRELUAȚI APELUL
APĂSAȚI ȘI ȚINEȚI APĂSAT PE > REFUZAȚI APELUL

ÎN TIMPUL UNUI APEL

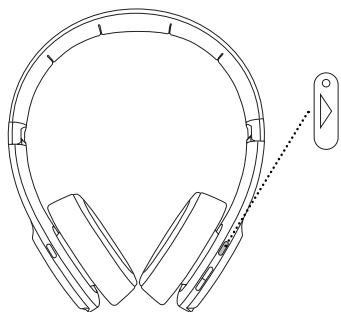

APĂSAȚI ȘI ȚINEȚI APĂSAT PE > TERMINARE APEL

ASISTENT VOCAL

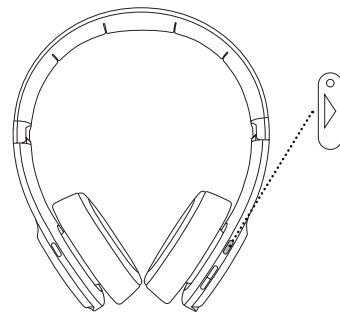

FACEȚI CLIC DE 2 ORI PE > ACTIVAȚI ASISTENTUL VOCAL

КНОПКИ



ИНДИКАТОРЫ

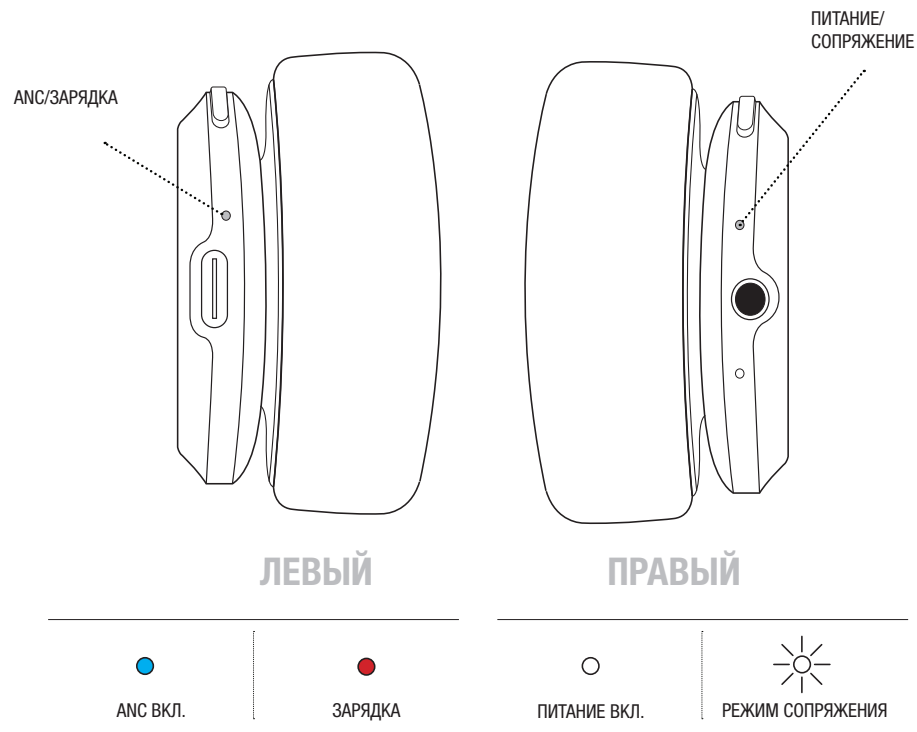

НАЧАЛО РАБОТЫ

1.

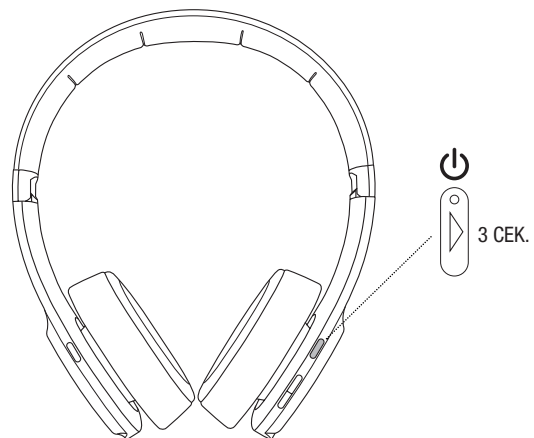

3.

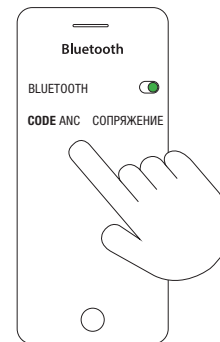

2.

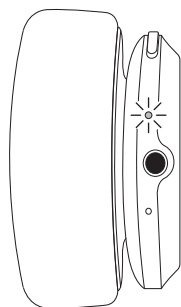

4.



ИСПОЛЬЗОВАНИЕ

ОБЫЧНОЕ ИСПОЛЬЗОВАНИЕ – ИСПОЛЬЗОВАНИЕ ANC

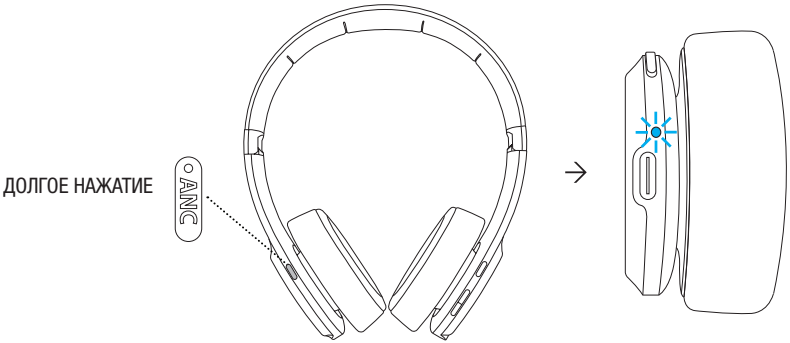

ПИТАНИЕ ВКЛ./ВЫКЛ.

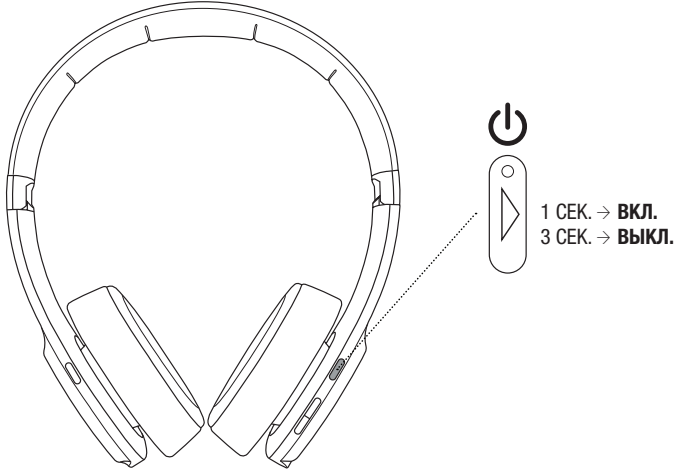

МУЗЫКА И ТЕЛЕФОННЫЕ ЗВОНКИ

ВОСПРОИЗВЕДЕНИЕ МУЗЫКИ

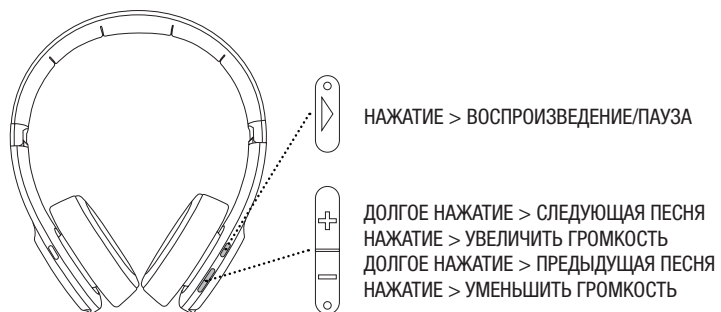

ВХОДЯЩИЙ ЗВОНОК



ПРИ ЗВОНКЕ

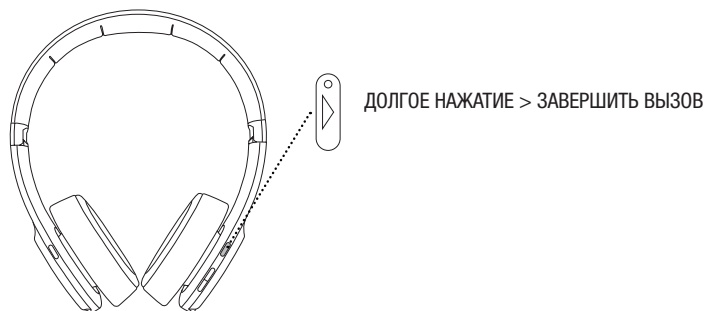

ГОЛОСОВОЙ ПОМОЩНИК



ΚΟΥΜΠΙΑ

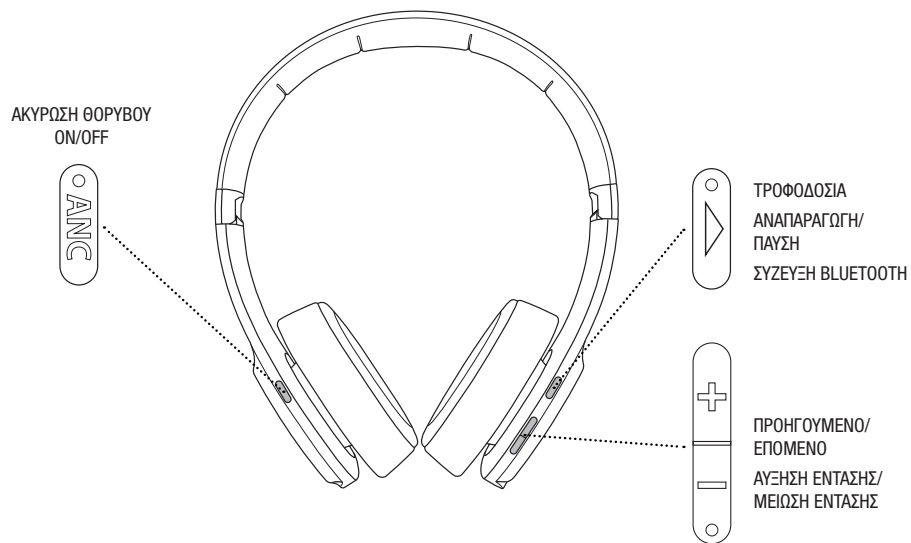

LED

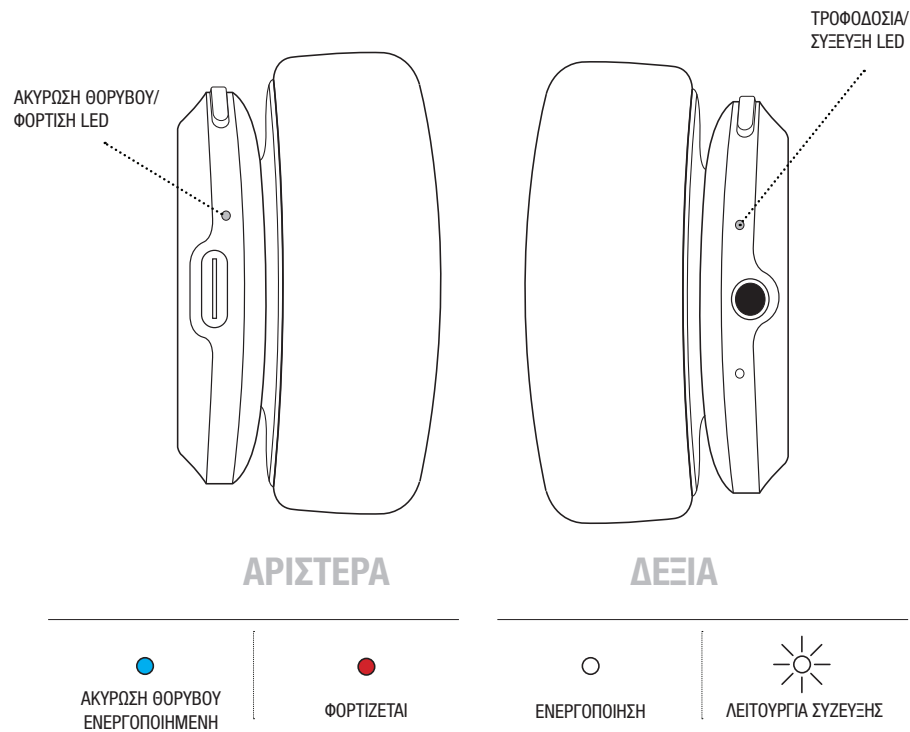

ΕΝΑΡΞΗ

1.

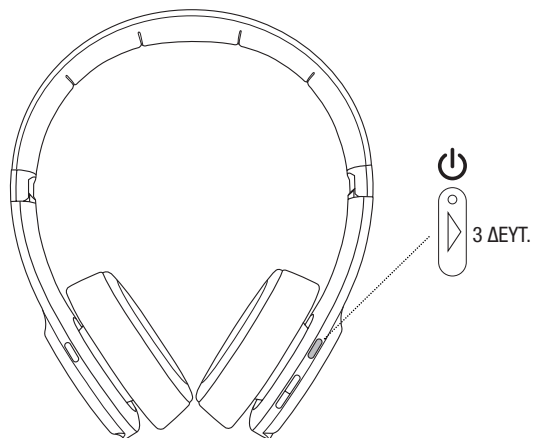

3.

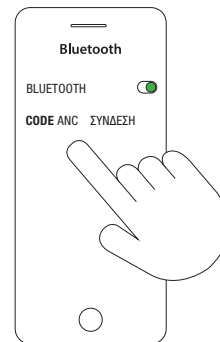

2.

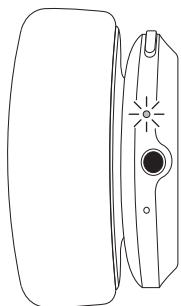

4.



ΛΕΙΤΟΥΡΓΙΑ

ΓΕΝΙΚΗ ΧΡΗΣΗ - ΛΕΙΤΟΥΡΓΙΑ ΑΚΥΡΩΣΗΣ ΘΟΡΥΒΟΥ



ΕΝΕΡΓΟΠΟΙΗΣΗ/
ΑΠΕΝΕΡΓΟΠΟΙΗΣΗ

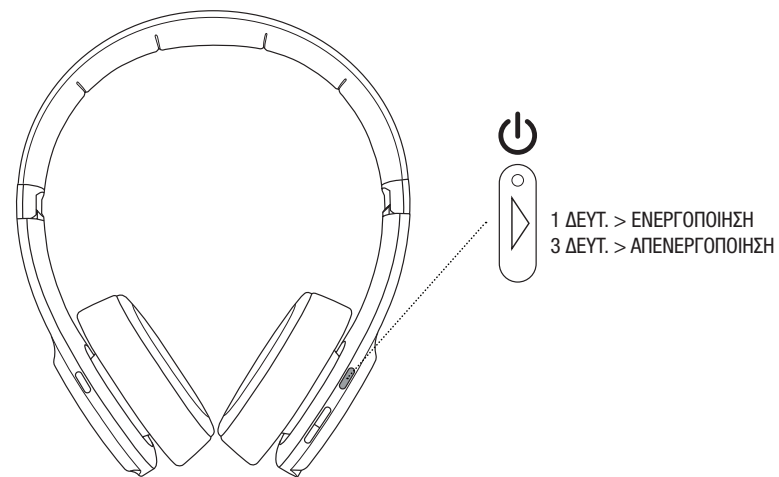

ΜΟΥΣΙΚΗ ΚΑΙ ΤΗΛΕΦΩΝΙΚΕΣ ΚΛΗΣΕΙΣ

ΑΝΑΠΑΡΑΓΩΓΗ ΜΟΥΣΙΚΗΣ

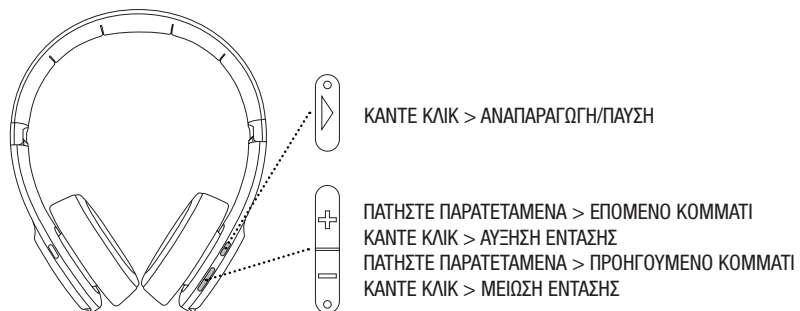

ΕΙΣΕΡΧΟΜΕΝΗ ΚΛΗΣΗ



ΚΑΤΑ ΤΗ ΔΙΑΡΚΕΙΑ ΜΙΑΣ ΚΛΗΣΗΣ

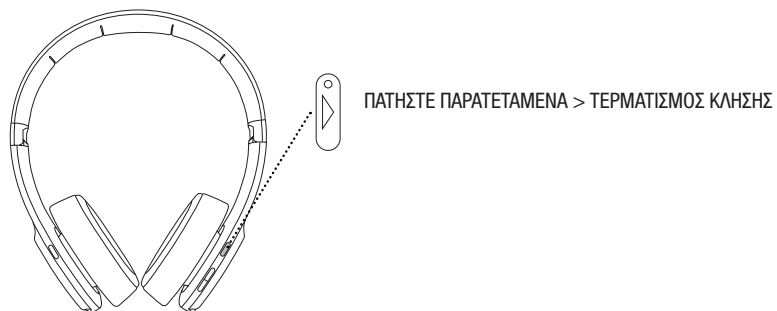

ΦΩΝΗΤΙΚΟΣ ΒΟΗΘΟΣ

