







A4CM

Assembly Instruction Athene Umbrella

	PARTS LIST	DESCRIPTION	QTY
A		Steel pole	1
B		Cross base	1
C		Cross base	1
D		Screw	4
E		Washer	4
F		Umbrella	1
G		Knod	2

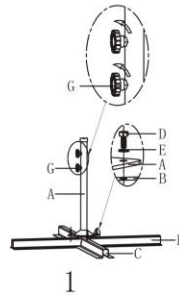

1

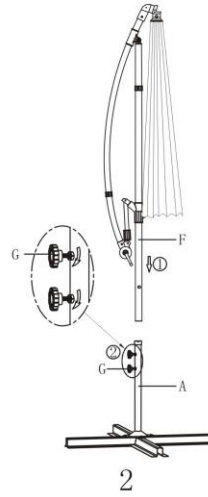

2

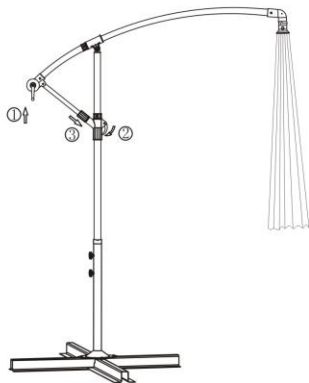

3

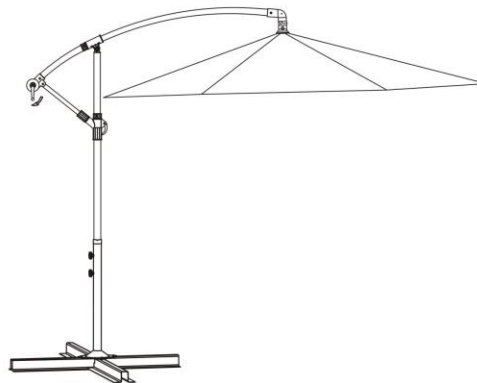

4

Customer Care:

Do not use in adverse weather condition. To ensure long life of the parasol, recommend that you store it away during adverse weather condition such as high wind, heavy rain, snow etc...

When the parasol is not in use take protection cover and place over parasol.