







ASSEMBLING INSTRUCTION

TABLE D148XH74 (21644NF/21656NF)

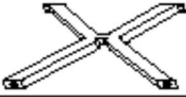
A		1pc	E	 M8*60	1pc
B		1pc	F	 Ø6mm	9pcs
C		1pc	G		1pc
D	 M6*20	8pcs			

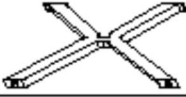
Note: first screw all bolts in by hand, before tightening.

①

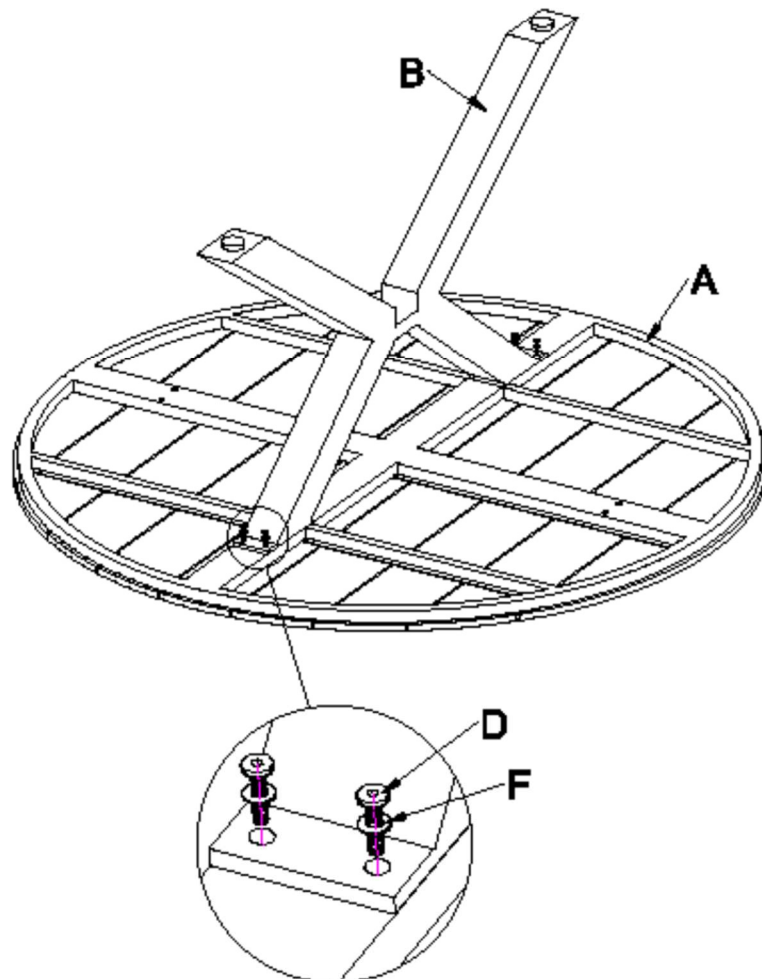

2

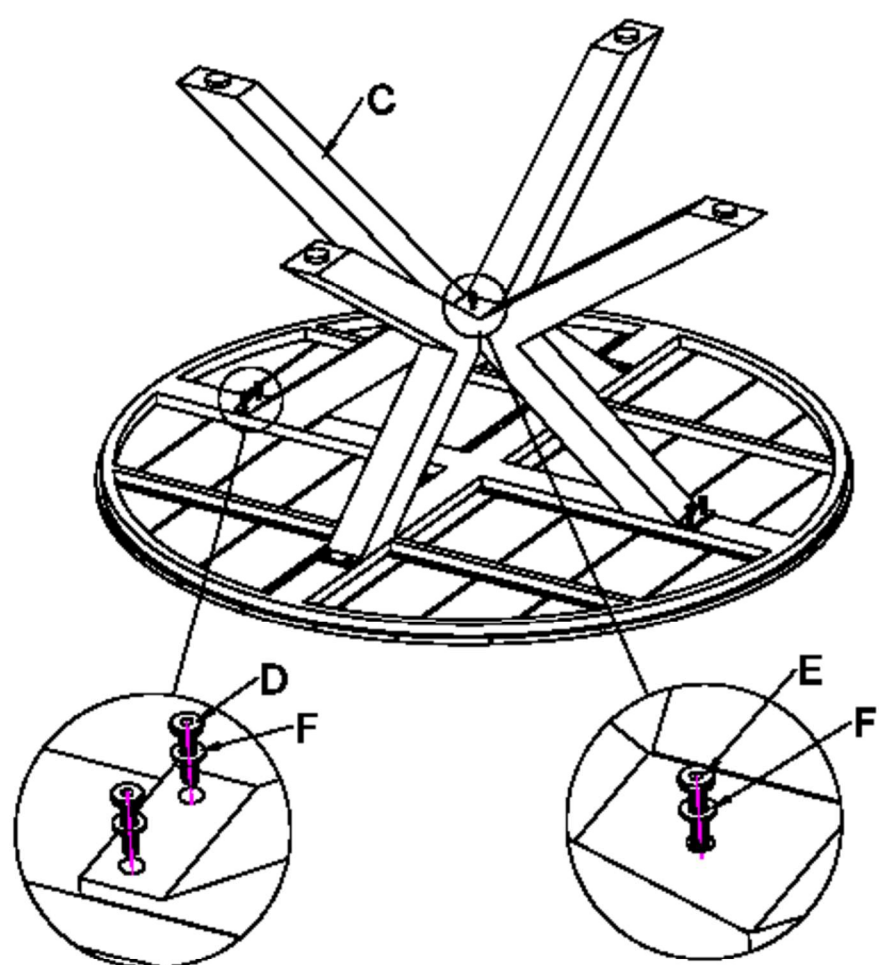

3

