

**SENCOR®**

SAC MT1230C

SAC MT1231C



## **EN ■ Portable air conditioner**

*Translation of the original manual*

### READ CAREFULLY AND STORE FOR FUTURE USE.

- This appliance may be used by children 8 years of age and older and by persons with physical or mental impairments or by inexperienced persons, if they are properly supervised or have been informed about how to use the product in a safe manner and understand the potential dangers. Cleaning and maintenance performed by the user must not be performed by unsupervised children. Children must not play with the appliance.
- If the power cord is damaged, it must be replaced by an authorised service centre or by another similarly qualified person, this will prevent the creation of a dangerous situation. It is forbidden to use the appliance if it has a damaged power cord.
- The appliance must be stored in a manner that prevents its mechanical damage.
- The appliance must be stored in a well ventilated location, where the dimensions of the room correspond to the dimensions specified for its operation.
- The appliance must be stored in a room where an open flame is not continuously in use (e.g. running gas appliance) or where there are sources of ignition (e.g. running electrical heating element).
- Before connecting the appliance to a power socket, check that the rated voltage on its rating label matches the electrical voltage in the power socket.
- Connect the appliance only to a properly grounded socket.
- The power socket must be freely accessible so that it is possible to quickly disconnect the power cord from the power source if necessary.
- The appliance is designed for use at home, in offices and similar types of areas. Do not use it in very dusty or humid rooms such as laundries or bathrooms, in areas where chemical or explosive substances are stored, in industrial surroundings or outdoors!
- Do not place the appliance in the vicinity of an open flame or appliances that are sources of heat.
- Do not place the appliance on unstable surfaces such as carpets with very long and thick fibres.
- The appliance may only be used on a dry, stable, smooth and horizontal surface.
- The appliance is equipped with travel wheels, so pay extra attention when handling it so that it does not fall down stairs or travel down from sloped areas. If necessary secure the wheels using the stoppers.
- Only use original parts to assemble the appliance. Before starting to assemble the appliance, make sure that it is turned off and disconnected from the power socket.
- Prior to connecting the appliance to a power socket, make sure that the appliance is correctly assembled according to the instructions in this user's manual.
- Do not touch the appliance with wet or damp hands. This applies especially when it is connected to a power socket.
- Do not expose the appliance to dripping or spraying water or submerge it in water or another liquid.
- Do not cover or insert anything into the air inlet or air outlet openings. Otherwise, this could damage the appliance.

- During operation there needs to be sufficient space for air circulation of at least 30 cm on all sides of the appliance.
- Do not expose yourself to a cold air current for a long time. This could have a negative effect on your health.
- To turn the appliance on or off, always use the appropriate buttons on the control panel or the remote control. Do not turn off the appliance by disconnecting the power cord from the power socket.
- Always turn off the appliance and disconnect it from the power socket when leaving it without supervision, when not using it and before moving, disassembling or cleaning it.
- Do not attempt to remove the outer case of the appliance.
- Disconnect the appliance from the power socket by pulling on the plug, never pulling on the power cord. Otherwise, this could damage the power cord or the socket.
- In the event that the power cord or power plug are damaged in any way, do not use the appliance.
- Store the appliance in a vertical position. It may be transported in a vertical position or tilted on the side. If you have already used the appliance, check that all the condensate has been drained. After transporting it, wait at least 1 hour before using the appliance.
- Do not use the appliance if it is not working correctly, if it has been damaged or has been submerged in water. To avoid a hazardous situation arising, do not repair the appliance yourself or modify it in any way. Have all repairs performed at an authorised service centre. By tampering with the appliance, you risk voiding your legal rights arising from unsatisfactory performance or quality warranty.
- Installation must be performed in accordance with the installation instructions. Incorrect installation may result in a water leak, injury by electrical shock or fire.
- To prevent the risk of fire or injury by electrical shock, do not use this appliance with a timer or any other similar device that could spontaneously start this appliance.
- The appliance must be installed in accordance with national electrical codes.
- Only use this product for the purposes that are described in this user's manual. Otherwise, this may result in damage or excessive noise and vibrations.
- Use only the accessories and components that are supplied together with the appliance and the tools explicitly intended for its installation. The use of non-standard parts and accessories may result in a water leak, injury by electrical shock, fire, injury or damage to property.
- DO NOT ADJUST the length of the power cord of the unit and do not use an extension cord for its power supply.
- DO NOT CONNECT the unit to a power socket to which other electrical appliances are already connected. The incorrect selection of an electrical power supply may result in a fire or injury by electrical shock.
- Do not cover the cable with a carpet. Do not place carpets, fillets or any other floor coverings on the power cord. Do not locate the cable underneath furniture or appliances. Lead the cable where nothing will ride over it and where nobody can trip over it. If this occurs, immediately disconnect the unit from the power socket.
- In the event that the unit is tipped over during use, turn it off and immediately disconnect it from the main power supply. Visually check that the unit has not been damaged in any way. In the event of any doubts that the unit has been damaged in any way, seek assistance from a technician or customer service.
- The power supply must be disconnected during a thunder storm to prevent damage to the appliance in the event of a lightning strike.
- Disconnect the power supply to the appliance if it makes a strange noise or if an odour or smoke is emitted.

Read this user's manual.

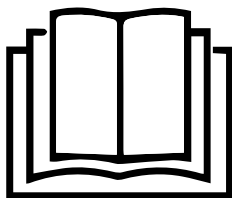

**Warning:**  
Fire hazard.









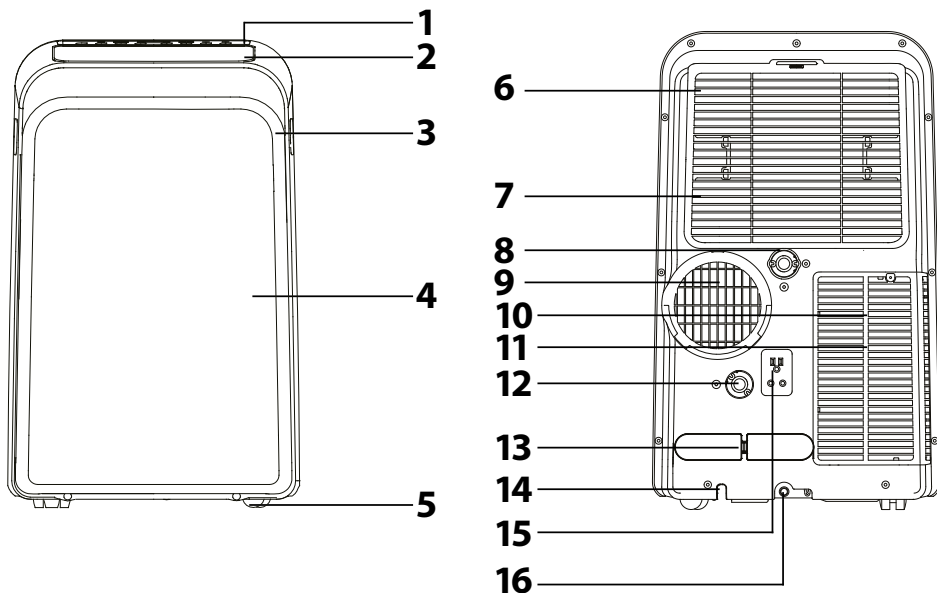



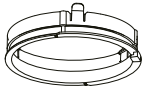
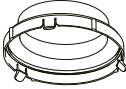

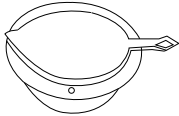
### **SPECIFIC INFORMATION FOR APPLIANCES USING REFRIGERANT GAS R290**

- Carefully study any warnings.
- For defrosting and cleaning, do not use any other tools than those recommended by the manufacturer.
- This appliance must be located in an environment that has no continuously running fire sources (for example an open fire, a gas appliance or electrical appliances).
- Do not perform any drilling and do not burn it.
- Refrigerant gases may be odourless.
- This appliance must be located in rooms with an area greater than 11 m<sup>2</sup>.
- This appliance contains approx. 220 g of refrigerant gas R290.
- R290 is a refrigerant gas that meets European environmental protection directives. Do not make holes or drill into any part of the cooling circuit.
- The room in which this appliance is installed, operated or stored must prevent the accumulation of such leaked refrigerants, that could be the cause of explosion or fire as a result of the refrigerant igniting following the start up of electrical heaters, cookers or other sources of ignition.
- The appliance must be stored in such a manner that its mechanical damage is prevented.
- Persons working with or repairing cooling circuits must have appropriate authorisation issued by an authorised institution that certifies this person's competence to work with refrigerants in accordance with the specific assessment of the association for this sector.
- Maintenance tasks must be performed solely on the basis of the recommendations of this appliance's manufacturer. Maintenance and repair tasks that required the contribution of other qualified expert personnel may only be performed under the supervision of specialised experts in the flammable refrigerants sector.
- Check the rating label for the type of refrigerant gas used in your appliance.
- Do not cover the vents.
- Adhere to national codes relating to gas.

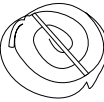
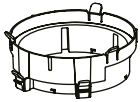
A

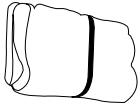

**B**

1		2		3	
4		5		6	
7		8		9	
10		11		12	
13		14		15	

**C**

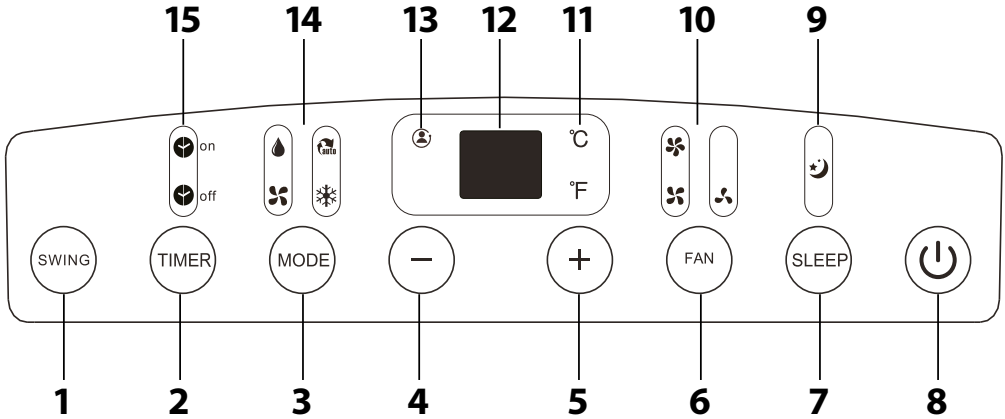

D

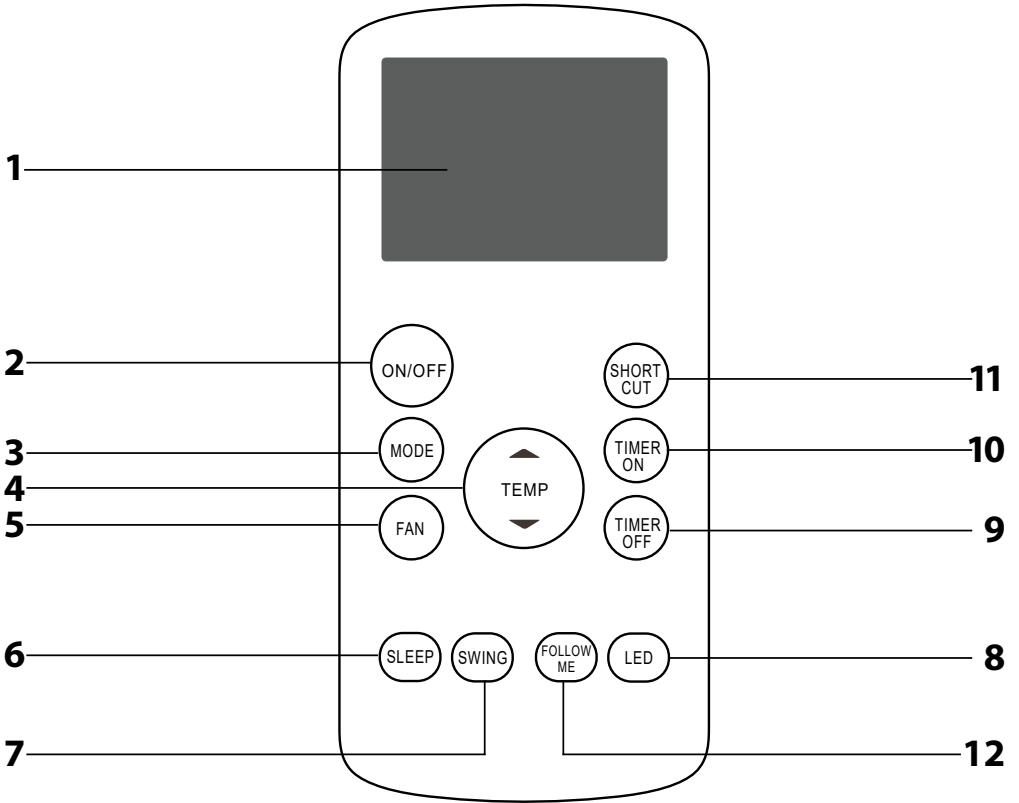

# EN Portable air conditioner

- Prior to using this appliance, please read the user's manual thoroughly, even in cases, when one has already familiarised themselves with previous use of similar types of appliances. Only use the appliance in the manner described in this user's manual. Keep this user's manual in a safe place where it can be easily retrieved for future use.
- We recommend saving the original cardboard box, packaging material, purchase receipt and responsibility statement of the vendor or warranty card for at least the duration of the legal liability for unsatisfactory performance or quality. In the event of transportation, we recommend that you pack the appliance in the original box from the manufacturer.

## DESCRIPTION OF THE APPLIANCE

<b>A1</b> Control panel	<b>B10</b> Bottom air filter (behind a protective grille)
<b>A2</b> Horizontal flap	<b>B11</b> Window air inlet
<b>A3</b> Handles (located along both sides)	<b>A12</b> Bottom drain outlet (only on models with heating mode)
<b>A4</b> Front panel	<b>A13</b> Power cord holder
<b>A5</b> Travel wheels	<b>A14</b> Power cord outlet
<b>A6</b> Top air filter (behind a protective grille)	<b>A15</b> Power plug storage compartment
<b>A7</b> Top air inlet	<b>A16</b> Condensate drain hole
<b>A8</b> Top drain outlet	
<b>A9</b> Air outlet	

## DESCRIPTION OF ACCESSORIES

<b>B1</b> Adapter A for connection to the back panel of the portable air conditioner	<b>B8</b> Gasket seal
<b>B2</b> Round adapter	<b>B9</b> Window connection adapter
<b>B3</b> Flexible air exhaust hose	<b>B10</b> Window insert
<b>B4</b> Flange with plug	<b>B11</b> Window insert plug
<b>B5</b> Dowels (4 pcs)	<b>B12</b> „L“ bracket
<b>B6</b> Screws (4 pcs)	<b>B13</b> Threaded screws (2 pcs)
<b>B7</b> Drain hose	<b>B14</b> Foam strips
	<b>B15</b> Textile window gasket seal

## DESCRIPTION OF THE CONTROL PANEL

<b>C1</b> SWING button for moving the flaps	<b>C9</b> Sleep mode indicator
<b>C2</b> TIMER button for setting the timer	<b>C10</b> Fan speed indicators (high / medium / low)
<b>C3</b> MODE button for selecting an operating mode	<b>C11</b> Temperature unit icons °C / °F
<b>C4</b> Minus (-) button	<b>C12</b> Display
<b>C5</b> Plus (+) button	<b>C13</b> Follow Me indicator
<b>C6</b> FAN button for setting the fan speed	<b>C14</b> Operating mode indicators
<b>C7</b> SLEEP button for setting the sleep mode	<b>C15</b> Timer on/off indicators
<b>C8</b> On/Off button 	

## REMOTE CONTROL

<b>D1</b> Display	<b>D8</b> LED button
<b>D2</b> On/Off button	<b>D9</b> TIMER OFF button for turning off the timer
<b>D3</b> MODE button for selecting an operating mode	<b>D10</b> TIMER ON button for turning on the timer
<b>D4</b> TEMP button 	<b>D11</b> SHORTCUT button
<b>D5</b> FAN button for setting the fan speed	<b>D12</b> FOLLOW ME button
<b>D6</b> SLEEP buttons for setting the sleep mode	
<b>D7</b> SWING button	

## INSTALLATION

### Installation location for the portable air conditioner

- Locate the portable air conditioner on an even, dry and stable surface and within reach of a grounded power socket.
- For easier handling, the portable air conditioner is equipped with travel wheels **A5**. Do not use the travel wheels **A5** when you need to move the air conditioner over carpets or similar surfaces. Avoid riding over objects.
- To achieve optimal efficiency, maintain a distance of at least 50 cm from the wall or other obstacles.



#### Note:

Do not use the portable air conditioner to cool a room where computer servers, etc. are located.

Installation, adjustment, maintenance and repairs must only be performed by a qualified person.

### Installing the flexible hose on to the portable air conditioner

- The flexible hose **B3** must be connected to the portable air conditioner and installed into a window in accordance with the operating modes that you wish to set. Install the flexible hose **B3** when you wish to select the operating modes: cooling or automatic mode. It is not necessary to install the flexible hose **B3** when you wish to select the fan or dehumidification mode.
- Extend the flexible hose **B3** to the required length. Put adapter **A1** on to the end of the flexible hose **B3**. Insert the flexible hose **B3** into the air outlet **A9** so that the

- tab in the bottom part of adapter **A1** fits into the cut-out in the air outlet **A9**. At the same time, check that the hook in the top part of adapter **A1** fits into the cut-out in the air outlet **A9**. Turn it in the direction of the arrow to secure the hose **B3** in place.
- Put the round adapter **B2** on to the free end of the flexible hose **B3**.

### Installing the flexible hose into a slide window

- The window insert **B10** is designed to be compatible with the majority of sliding windows (vertical and horizontal). Nevertheless, for certain types of slide windows it may be necessary to modify the installation procedure described below.
- Open the sliding window sash and stick on the gasket seal **B8** along the entire perimeter of the area where the window insert **B10** will be located. Place the window insert **B10** into the window. Adjust the dimensions of the window insert **B10** to the width of the window (on a vertical slide window) / height of the window (on a horizontal slide window). If necessary, cut away a part of the window insert **B10** if the window is too small. To prevent the entry of hot air or insects into the room, cut off the foam strip **B14** so that it fits into the area between the windows. If necessary, screw on the „L“ brackets **B12** using the threaded screws **B13** to secure the position of the window in which the window insert **B10** is installed. Insert the flexible hose hose **B3** with the attached adapter **B9** into the hole in the window insert **B10**.



#### Note:

Avoid excessive bending of the hose. To ensure proper operation of the portable air conditioner, it is important not to overload the hose or to bend it unnecessarily. Excessive loading or bending may damage the hose.

### Installing the flexible hose using the textile gasket seal

- The textile gasket seal **B15** is suitable for tilt-open, sash and roof windows. The textile gasket seal **B15** is fitted with a Velcro zip tape to make its installation in the window easier. Open the window and into the created crevice install the textile gasket seal **B15**. We recommend that you thoroughly degrease the location where you will be attaching the textile gasket seal **B15** using an appropriate cleaning agent. Remove the protective paper strip and stick the tape on to the window frame.
- In order to be able to insert the flexible hose **B3**, the gasket seal is fitted with an integrated zip. Open the zip in such a location that will enable you to easily insert the flexible hose **B3**.
- It is not necessary to remove the textile gasket seal **B15** from the window when not using the portable air conditioner. The window can be closed even with the gasket seal installed.

### Installing the flexible hose into a wall

- It is important that the installation into a wall is performed by a qualified technician.
- Drill a hole into the wall with a hole diameter of 125 mm at a height between 30 cm and 120 cm from floor. Insert the flange with plug **B4** into the hole and secure it to the wall using the set of screws **B6** and dowels **B5**.
- Extend out the flexible hose **B3**, open the plug of the flange **B4** and insert the flexible hose **B3** into the flange. Avoid excessive bending of the hose.
- When not using the portable air conditioner, close the plug on the flange **B4**.



#### Note:

To ensure proper operation of the portable air conditioner, it is important not to overload the hose or to bend it unnecessarily. Excessive loading or bending may damage the hose.

## CONTROLS OF THE PORTABLE AIR CONDITIONER

### A. CONTROL PANEL

- Insert the power plug into a power socket. Now the portable air conditioner sets itself to the stand-by mode.

### Turning the portable air conditioner on and off

- To turn on the portable air conditioner, press button  **C8**. Press it again to turn the portable air conditioner off.







#### Note:





Never turn off the portable air conditioner by pulling the power cord out of the power socket. Turn off the portable air conditioner using button  **C8**, wait a few minutes and then pull out the power cord.

## OPERATING MODES

### 1. Cooling mode

- Repeatedly press button **MODE C3** until the cooling indicator  is lit. Using the -/+ buttons, set the desired temperature. You can set the temperature in the range from 17 to 30 °C.
- Using button **FAN C6**, set the fan speed. Repeatedly press button **FAN C6** to switch the speed in the following order:  (high speed) -  (medium speed) -  (low speed) - automatic speed (depending on the model, all indicator lights are either lit or not lit). Each time the button is pressed, the respective indicator will be lit on the control panel.

### 2. Fan mode

- Repeatedly press button **MODE C3** until the fan mode indicator  is lit. Using button **FAN C6**, set the fan speed. Repeatedly press button **FAN C6** to switch the speed in the following order:  (high speed) -  (medium speed) -  (low speed) - automatic speed (depending on the model, all indicator lights are either lit or not lit). Each time the button is pressed, the respective indicator will be lit on the control panel. In this mode, it is not possible to set the temperature, nor is it necessary to connect the flexible hose **B3** to the portable air conditioner.



### 3. Dehumidification mode

- Make sure that the flexible hose **B3** is disconnected from the air conditioner. Repeatedly press button **MODE C3** until the dehumidification indicator  is lit. It is not possible to set the temperature or fan speed in this mode. The fan speed is automatically set.

### 4. Automatic mode

- In the automatic mode, the portable air conditioner will automatically set the operating mode (cooling / fan / dehumidification) depending on the set temperature and the temperature in the room. The portable air conditioner will automatically control the temperature in the room based on the temperature that you set. It is not possible to set the fan speed in the automatic mode.
- Repeatedly press button **MODE C3** until the automatic mode indicator  is lit. In the automatic mode both the automatic mode indicators as well as the indicator of the selected operating mode will be lit.

## FUNCTIONS OF THE PORTABLE AIR CONDITIONER

### 1. Timer functions

- While the portable air conditioner is turned on, press the **TIMER C2** button. You will enter the automatic shut-off mode and "TIMER OFF" will be shown on the display **C12**. Use the **- / +** buttons to set the desired duration. Press the **TIMER C2** button within 5 seconds to enter the automatic start mode. "TIMER ON" will be shown on the display **C12**. Use the **- / +** buttons to set the desired duration.
- While the portable air conditioner is turned off, press the **TIMER C2** button and use the **- / +** buttons to set the desired duration. Press the **TIMER C2** button within 5 seconds to enter the automatic shut-off mode. Use the **- / +** buttons to set the desired duration.
- The desired start / shut-off duration can be set in 30-minute increments (up to 10 hours) and in 1-hour increments (up to 24 hours). The portable air conditioner will automatically countdown the set duration.
- The portable air conditioner will automatically switch to the previously set temperature if no button is pressed within 5 seconds.
- If you need to turn off the timer, turn the portable air conditioner on or off, or alternatively set the timer to 0 hours.

### 2. Sleep function

- The sleep function is used to reduce overnight power consumption.
- Press the **SLEEP C7** button. The temperature will increase by 1 °C within 30 minutes. Within the next 30 minutes the temperature will increase by another 1 °C. The portable air conditioner will maintain this new temperature for a further 7 hours. The temperature setting will then return to the initially set temperature and the sleep function will be automatically cancelled.



#### Note:

This function cannot be set in the fan and dehumidification modes.

### 3. Flap swing function

- Press the **SWING C1** button to automatically start the swinging motion of the flap. While the flap is swinging, press the **SWING C1** button again to stop the flap at a certain angle.



#### Note:

When the portable air conditioner stops its operation, it will not be possible to start it again for approximately 3 minutes. This is a standard protection feature. It can be put back into operation after 3 minutes.

## B. REMOTE CONTROL

### Inserting and replacing batteries

- Slide out the battery compartment cover, which is located on the rear side of the remote control. Place two AAA/LR03 (2x 1.5V) alkaline batteries into the battery compartment and close the cover.
- When inserting the batteries ensure the correct polarity as shown in the battery compartment.
- When replacing the batteries, always use batteries of the same type, never combine old and new batteries or batteries of various types.



#### Note:

Removing the batteries from the remote control will delete all the settings. After new batteries are inserted the default remote control settings as programmed by the manufacturer will be renewed. If you will not be using the remote control for longer than 2 months, remove the batteries.

### Using the remote control

- For the remote control to work correctly, ensure that the maximum distance of the remote control from the portable air conditioner is not greater than 7 m and that there is no obstacle between the remote control and the portable air conditioner that could prevent the transmission of the signal.
- Point the remote control directly at the portable air conditioner. The transmission of the signal is confirmed by a short sound signal.
- Do not expose the remote control to direct sunlight or high temperatures. Otherwise the signal may not be transmitted.



#### Note:

Do not combine old and new batteries or batteries of various types. Never put the batteries in a fire, short circuit them or damage them in any way. Dispose of them ecologically at the end of their lifetime. Never throw batteries out with communal waste.

### Turning the portable air conditioner on and off

To turn on the portable air conditioner, press button **D2** once. Press button **D2** again to turn the portable air conditioner off.

## OPERATING MODES

### 1. Cooling mode

- Repeatedly press button **MODE D3** until the cooling indicator  is lit. Using the **▲ / ▼** buttons, set the desired temperature. You can set the temperature in the range from 17 to 30 °C.
- Repeatedly press the **FAN D5** button to set the fan speed: high speed – medium speed – low speed – automatic speed.
- Press button **D2** to turn the portable air conditioner on in the cooling mode.

### 2. Fan mode

- Repeatedly press button **MODE D3** until the fan mode indicator  is lit.
- Repeatedly press the **FAN D5** button to set the fan speed: high speed – medium speed – low speed – automatic speed.
- Press button **D2** to turn the portable air conditioner on in the fan mode.
- Note:** In the fan mode, it is not possible to set the temperature, therefore no temperature information will be shown on the display **D1**.

### 3. Dehumidification mode

- Repeatedly press button **MODE D3** until the dehumidification indicator  is lit.
- It is not possible to set the temperature or fan speed in this mode. The fan speed is automatically set.
- Press button **D2** to turn the portable air conditioner on in the dehumidification mode.

### 4. Automatic mode

- If you select an automatic mode, the portable air conditioner will automatically select an operating mode based on the temperature in the room.
- Repeatedly press button **MODE D3** until the automatic mode indicator  is lit.
- Press button **D2** to turn the portable air conditioner on in the automatic mode.

## FUNCTIONS OF THE PORTABLE AIR CONDITIONER

### 1. Automatic start and shut-off function

#### Automatic start

- The automatic start function makes it possible to set a time after which the portable air conditioner will start automatically.
- Press the **TIMER ON D10** button. The last set time and "h" (hours) will start flashing on the display **D1**.
- Repeatedly press the **TIMER ON D10** button and set the time in hours after which the portable air conditioner will turn on automatically. The digits on the display **D1** represent the time in hours.
- Wait approximately 2 seconds and the automatic start function will be activated. The set temperature is then shown on the then display **D1**.

#### Automatic shut-off

- The automatic shut-off function makes it possible to set a time after which the portable air conditioner will shut off automatically.
- Press the **TIMER OFF D9** button. The last set time and "h" (hours) will start flashing on the display **D1**.
- Repeatedly press the **TIMER OFF D9** button and set the time in hours after which the portable air conditioner will turn off automatically. The digits on the display **D1** represent the time in hours.
- Wait approximately 2 seconds and the automatic start function will be activated. The set temperature is then shown on the then display **D1**.



#### Note:

The automatic shut-off or start time can be set in the range between 30 minutes and 24 hours (set in 30 minute intervals until 10 hours, and one hour intervals until 24 hours).

In the event that you need to cancel the automatic shut-off or start function, set the time to "0.0".

#### Setting automatic start and shut-off at the same time

- When setting the automatic start and shut-off, it is necessary to take into consideration the current time since the start and shut-off time will be counted down from it.
- Press the **TIMER ON D10** button. The last set time and "h" (hours) will start flashing on the display **D1**. Repeatedly press the **TIMER ON D10** button and set the time in hours after which the portable air conditioner will turn on automatically. Wait approximately 3 seconds and the automatic start function will be activated.
- Now press the **TIMER OFF D9** button. The last set time and "h" (hours) will start flashing on the display **D1**. Repeatedly press the **TIMER OFF D9** button and set the time in hours after which the portable air conditioner will turn off automatically. Wait approximately 3 seconds and the automatic start function will be activated.

### 2. Sleep function

The sleep function is used to reduce overnight power consumption.

Press button **D6**, and the  symbol will appear on the display **D1**. The portable air conditioner will run in the last selected mode, however, this function cannot be set in the fan and dehumidification modes.

### 3. Flap angle setting function

- Button **D7** serves to start or stop the motion of the flap. The flap can be set to 6 different angles. A different angle is set each time the button is pressed. Holding down button **D7** activates the automatic motion of the flap.

### 4. SHORTCUT function

- This function serves to restore the current settings or to restore the previous settings.
- While the remote control is turned on, press the button **SHORTCUT D11** to automatically switch to the previous settings, including the operating mode, set temperatures, fan speed and the sleep function, if it was activated.
- When the button **SHORTCUT D11** is held down for approximately 2 seconds, the original settings will automatically be restored, including the operating mode, set temperatures, fan speed and the sleep function, if it was activated.

### 5. Follow Me function

The remote control serves as a remote thermostat allowing for the precise temperature control at its location.

To activate the Follow Me feature, point the remote control towards the unit and press the FOLLOW ME **D12**. The remote control will send this signal to the air conditioner until press the FOLLOW ME **D12** again. If the unit does not receive the Follow Me signal during any 7 minutes interval, the unit will exit the Follow Me mode.



#### Note:

This feature can be activated from the remote control only. This feature is unavailable under FAN or DRY mode.

## MAINTENANCE AND CLEANING

- Before cleaning the portable air conditioner, turn it off and wait a few minutes, and then pull the power cord out of the power socket.

### Cleaning the air filters

- When the portable air conditioner is used regularly, it is necessary to clean the air filters (**A6** and **A10**) located behind the protective grille of the top and bottom air inlets **A7** and **A11** at least once every 14 days to prevent the fan from being clogged by dust.
- Carefully remove the protective grilles and remove the filters (**A6** and **A10**). To remove the dust, use a vacuum cleaner. In the event of greater soiling, wash the filters (**A6** and **A10**) in a solution of lukewarm water (max. 40 °C) and neutral detergent. Then thoroughly rinse under running water and allow to dry naturally. Do not dry it in a clothes dryer or in direct sunlight. Once the filters (**A6** and **A10**) are dry, you can install them back in their place.



#### Note:

Do not use the portable air conditioner without the air filters (**A6** and **A10**) properly installed and do not use it with wet or damp air filters (**A6** and **A10**).

### Condensate tank

- The condensate tank must be drained immediately when the error message P1 appears on the display **C12** and also before this appliance is stored in order to prevent the formation of moulds.

### Cleaning the outer case

- To clean the outer case, use a soft wiping cloth dipped in a solution of lukewarm water and neutral detergent. Then wipe the surface dry.
- When cleaning it, do not spray the portable air conditioner with water or any other liquid, do not pour water on it or submerge it in water or in any other liquid.
- Do not use abrasive cleaning products, solvents, petrol, etc. for cleaning.



#### Note:

In households with pets, it is necessary to wipe the grille regularly to prevent it from becoming clogged by animal fur.

### Storing the portable air conditioner

- In order to dry it and to prevent the formation of moulds, leave the portable air conditioner running in a warm room in the fan mode for approximately 12 hours.
- Disconnect the flexible hose **B3** and store it in a safe place out of the reach of children.
- Drain all the condensate from the water tank – see chapter "Condensate drain outlet".
- Clean the air filters (**A6** and **A10**) and reinstall them. Wipe the outer case of the portable air conditioner. Remove the batteries from the remote control.
- Store the air conditioner in a cool, dry and dark location.

### Condensate drain outlet

If the water level inside the water tank reaches a predetermined level, the portable air conditioner will show the error message P1 on the display **C12**. In order to drain the condensate from the air conditioner, proceed as follows:

1. Disconnect the power plug from the power socket.
2. Carefully re-locate the portable air conditioner to a location where the water may be drained.
3. Underneath the drain outlet **A16**, place a container into which the condensate will flow. Carefully remove the plug of the drain outlet **A16**. Connect the drain hose **B7** and allow the condensate to flow out.
4. Once the water tank is empty (condensate has stopped flowing), disconnect the drain hose **B7** and put the plug back into the drain outlet **A16**.
5. Insert the power plug into a power socket and turn on the portable air conditioner. If you need to ensure the condensate to be continuously drained from the portable air conditioner, it is possible to connect the drain hose **B7** to a waste water drain. Proceed as follows:

1. Disconnect the power plug from the power socket.
2. Remove the plug of the drain outlet **A16**. Connect the drain hose **B7**. If the length of the drain hose **B7** is insufficient, then it is necessary to purchase a longer hose of the same type. Never extend the length of the drain hose **B7** using extensions.
3. Connect the end of the drain hose **B7** to the waste water drain.
4. Insert the power plug into a power socket and turn on the portable air conditioner.



#### Note:

The drain hose **B7** should be installed at the same height or lower than the top drain outlet **A16**. Otherwise, the condensate will not be properly drained from the water tank.

### Putting into operation again

- Check that the power cord and plug are not damaged and that the air filters are clean. Insert a new set of batteries into the remote control. Proceed according to the instructions in section "Inserting and replacing batteries". Install the portable air conditioner according to the instructions contained in the preceding part of this user's manual "Installation".

## TROUBLESHOOTING

Before contacting an authorised service centre, please check the appliance according to the following instructions:

Problem	Cause	Solution
The portable air conditioner does not turn on when the ON/OFF button is pressed.	Error message P1.	The condensate tank is full. Turn off the portable air conditioner and drain the condensate from the condensate tank according to the instructions in the section "Condensate drain outlet" in the preceding part of this user's manual.
	In the cooling mode: the temperature in the room is lower than the set temperature.	Adjust the set temperature.
The portable air conditioner does not cool sufficiently.	The air filter is clogged with dust and animal fur.	Turn off the portable air conditioner and clean out the filter according to the instructions in chapter "Maintenance and cleaning".
	The flexible air exhaust hose is not connected or it is clogged.	Turn off the portable air conditioner and check the hose connection, or if necessary, remove any material inside the hose.
	There is an insufficient amount of refrigerant gas in the portable air conditioner.	Contact an authorised service centre.
	You set a temperature that is too high.	Lower the set temperature.
The portable air conditioner is too noisy and vibrates too much.	Windows or doors are open.	Close any windows or doors.
	The room is too large.	Check recommended room area.
	A heat source is turned on in the room.	Turn off the heat source.
	The portable air conditioner is located on an uneven surface.	Move the portable air conditioner to an even and level surface.
	The air filter is clogged with dust and animal fur.	Turn off the portable air conditioner and clean out the filter according to the instructions in chapter "Maintenance and cleaning".
The portable air conditioner is emitting gurgling sounds.	The noise is caused by the movement of the refrigerant inside the portable air conditioner.	This is normal.



#### Note:

In the event that one of the aforementioned faults occurs, turn off the portable air conditioner and check for the cause of the fault. Turn it on again, and if the fault reoccurs, turn it off, disconnect the power cord from the power socket and contact the manufacturer, an authorised service centre or a person with relevant qualifications and have the unit repaired.

## Error messages

Error messages may appear on the display **C12** during operation:

Error message	Meaning	Solution
<b>E1</b>	Heat sensor error	Contact an authorised service centre.
<b>E2</b>	Evaporation temperature sensor error	Contact an authorised service centre.
<b>E3</b>	Condensate temperature sensor error	Contact an authorised service centre.
<b>E4</b>	Display panel error	Contact an authorised service centre.
<b>EC</b>	Refrigerant leak	Contact an authorised service centre.
<b>P1</b>	The condensate tank is full.	Connect the drain hose – proceed according to the instructions in section "Condensate drain outlet".

## TECHNICAL SPECIFICATIONS

### SAC MT1230C / SAC MT1231C

Power supply	220 – 240 V ~ / 50 Hz
Cooling power output	12 kBtu/hour
Power input:	1,600 W
Current consumption	8 A
EER cooling factor	2.6 W/W
Dehumidification capacity	3.516 l / hour
Capacity of the built-in condensate tank	1 l
Refrigerant type and weight	R290/220 g
Air flow volume	420 / 370 / 355 (Hi / Mi / Lo)
Noise level	63 dB (A)
Maximum permitted value of excess operating pressure:	2.6 / 1.0 MPa
Suction/exhaust part of the cooling circuit	
Dimensions of the portable air conditioner (w x d x h)	467 x 397 x 765 mm
Weight	33 kg (net)
Operating temperature (cooling)	17 – 30 °C
Recommended room area	16 - 23 m <sup>2</sup>

The declared noise emission level of the appliance is 63 dB(A), which represents a level A of sound power with respect to a reference sound power of 1 pW.



#### Note:

The efficiency of the portable air conditioner may be reduced in the event that it is used outside the above described operating temperature range.

We reserve the right to change text and technical specifications.

## INSTRUCTIONS AND INFORMATION REGARDING THE DISPOSAL OF USED PACKAGING MATERIALS

Dispose of used packaging material at a site designated for waste in your municipality.

## DISPOSAL OF USED ELECTRICAL AND ELECTRONIC EQUIPMENT



This symbol on products or original documents means that used electric or electronic products must not be added to ordinary municipal waste. For proper disposal, renewal and recycling hand over these appliances to determined collection points. Alternatively, in some European Union states or other European countries you may return your appliances to the local retailer when buying an equivalent new appliance.

Correct disposal of this product helps save valuable natural resources and prevents potential negative effects on the environment and human health, which could result from improper waste disposal. Ask your local authorities or collection facility for more details.

In accordance with national regulations penalties may be imposed for the incorrect disposal of this type of waste.

### For business entities in European Union states

If you want to dispose of electric or electronic appliances, ask your retailer or supplier for the necessary information.

### Disposal in other countries outside the European Union.

This symbol is valid in the European Union. If you wish to dispose of this product, request the necessary information about the correct disposal method from the local council or from your retailer.



This product meets all the basic requirements of EU directives related to it.