

# Moulinex®

## Optimo 39L

FR

NL

DE

EN

ES

IT

PT



[www.moulinex.com](http://www.moulinex.com)

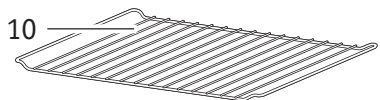
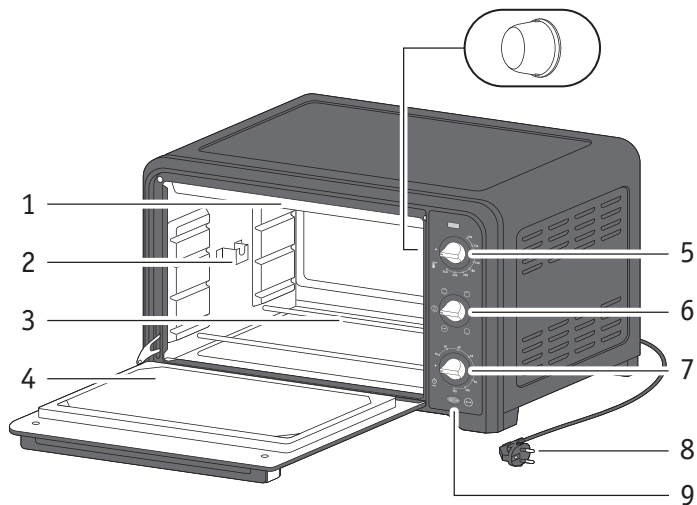

\* selon modèle - afhankelijk van het model - je nach Modell - depending on the model - según el modelo - in base al modello - consoante o modelo

## DESCRIPTION

- 1 Résistance supérieure
- 2 Parois aluminium
- 3 Résistance inférieure
- 4 Porte double parois
- 5 Bouton de réglage température
- 6 Bouton des fonctions
- 7 Bouton de minuterie
- 8 Cordon d'alimentation
- 9 Voyant de fonctionnement
- 10 Grille réversible
- 11 Plat lèche-frite\*
- 12 Accessoire tourne-broche\*
- 13 Poignée support tourne-broche\*
- 14 Spatule\*
- 15 Pierre à pizza\*

## BESCHRIJVING

- 1 Bovenste verwarmingselement
- 2 Aluminium wanden
- 3 Onderste verwarmingselement
- 4 Dubbelwandige deur
- 5 Regelbare thermostaatknop
- 6 Functieknop
- 7 Timerknop
- 8 Snoer
- 9 Aan/uit-controlelampje
- 10 Omkeerbaar grillrooster
- 11 Ovenschaal\*
- 12 Draaispit\*
- 13 Handgreep voor rooster en ovenschaal\*
- 14 Spatel\*
- 15 Pizzasteen\*

## BESCHREIBUNG

- 1 Oberes Heizelement
- 2 Aluminiumwände
- 3 Unteres Heizelement
- 4 Doppelwandige Tür
- 5 Temperaturregler
- 6 Funktionsknopf
- 7 Timer-Knopf
- 8 Netzkabel
- 9 Betriebskontrollleuchte
- 10 Umkehrbarer Grillrost
- 11 Backblech\*
- 12 Grillspieß\*
- 13 Grillrost und Backblechhalter\*
- 14 Pizzawender\*
- 15 Pizzastein\*

## DESCRIPTION

- 1 Top heating element
- 2 Aluminium walls
- 3 Bottom heating element
- 4 Double-wall door
- 5 Temperature control button
- 6 Functions button
- 7 Timer button
- 8 Power cord
- 9 Power indicator light
- 10 Reversible grill rack
- 11 Food tray\*
- 12 Rotisserie\*
- 13 Grill Rack & Food Tray Handle\*
- 14 Spatula\*
- 15 Pizza stone\*

## DESCRIPCIÓN

- 1 Resistencia superior
- 2 Paredes aluminio
- 3 Resistencia inferior
- 4 Puerta de doble cristal
- 5 Botón de ajuste de temperatura
- 6 Botón de funciones
- 7 Botón de temporizador
- 8 Cable de alimentación
- 9 Indicador de funcionamiento
- 10 Parrilla de grill reversible
- 11 Bandeja de comida\*
- 12 Asador\*
- 13 Asa de la parrilla y la bandeja de alimento\*
- 14 Pala\*
- 15 Piedra para pizza\*

## DESCRIZIONE

- 1 Elemento riscaldante superiore
- 2 Pareti in alluminio
- 3 Elemento riscaldante inferiore
- 4 Porta a doppia parete
- 5 Pulsante di regolazione della temperatura
- 6 Pulsante funzioni
- 7 Pulsante timer
- 8 Cavo di alimentazione
- 9 Spia di alimentazione
- 10 Griglia di cottura reversibile
- 11 Vassoio degli alimenti\*
- 12 Girarrosto\*
- 13 Manico per griglia & teglia\*
- 14 Pala\*
- 15 Pietra per pizza\*

## DESCRIÇÃO

- 1 Resistência superior
- 2 Paredes alumínio
- 3 Resistência inferior
- 4 Porta de parede dupla
- 5 Botão deregulação da temperatura
- 6 Botão das funções
- 7 Botão temporizador
- 8 Cabo de alimentação
- 9 Luz piloto de funcionamento
- 10 Grelha reversível
- 11 Tabuleiro\*
- 12 Espeto\*
- 13 Grelha e pega da bandeja da comida\*
- 14 Espátula\*
- 15 Pedra para pizza\*

\* selon modèle - afhankelijk van het model - je nach Modell - depending on the model - según el modelo - in base al modello - consoante o modelo

1

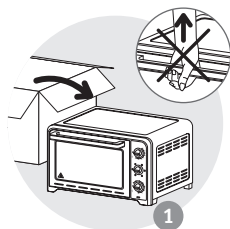

1

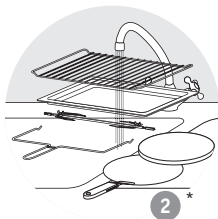

2

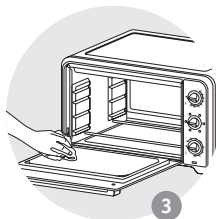

3

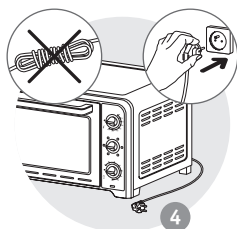

4

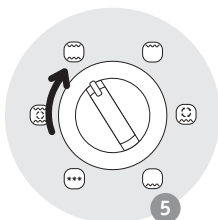

5

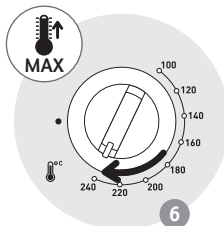

6

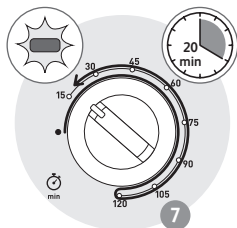

7

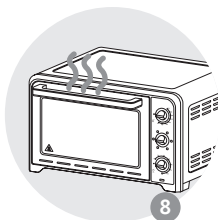

8

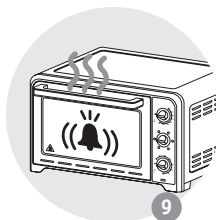

9

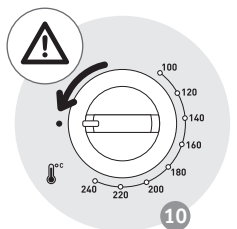

10

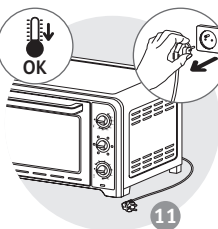

11

\* selon modèle - afhankelijk van het model - je nach Modell - depending on the model - según el modelo - in base al modello - consoante o modelo

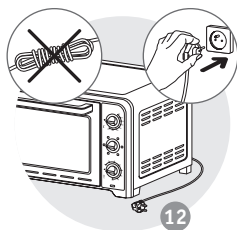

12

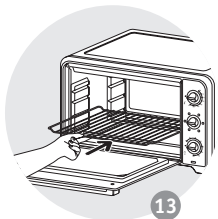

13

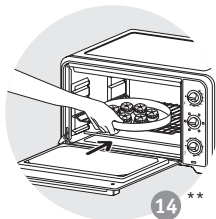

14 \*\*

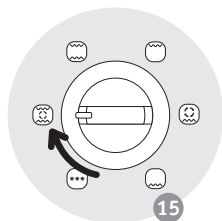

15

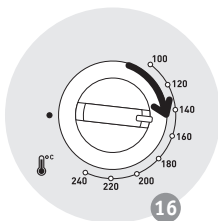

16

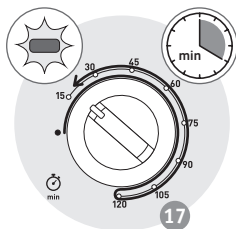

17

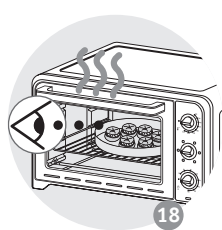

18

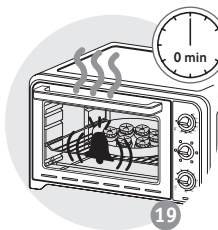

19

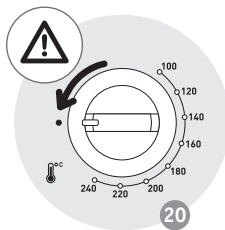

20

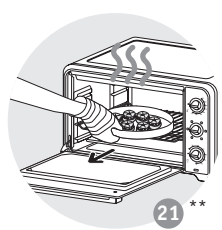

21 \*\*

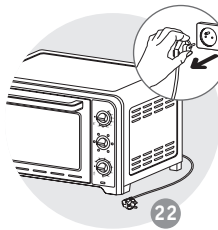

22

\*\* Plat non fourni avec l'appareil  
 Schaal niet bij het apparaat inbegrepen  
 Platte nicht im Lieferumfang inbegriffen  
 The dish is not supplied with the appliance  
 El plato no es suministrado con el aparato  
 Piatto non fornito con l'apparecchio  
 Travessa não fornecida com o aparelho

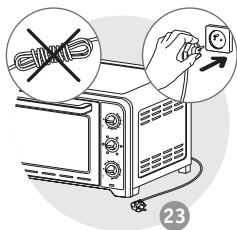

23

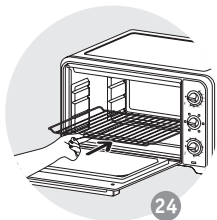

24

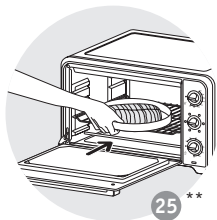

25 \*\*

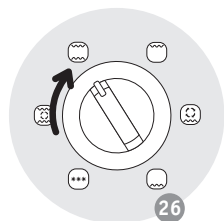

26

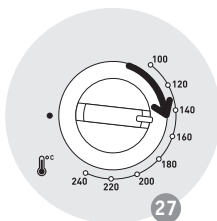

27

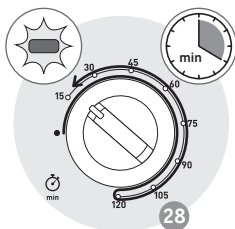

28

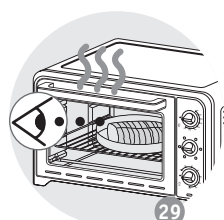

29

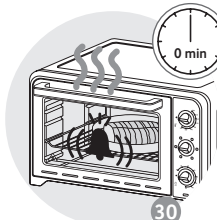

30

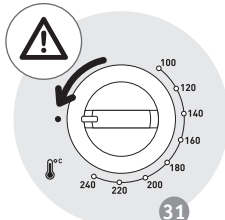

31

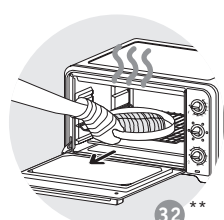

32 \*\*

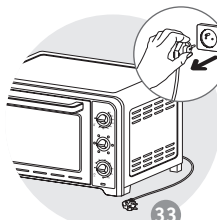

33

\*\* Plat non fourni avec l'appareil  
 Schaal niet bij het apparaat inbegrepen  
 Platte nicht im Lieferumfang inbegriffen  
 The dish is not supplied with the appliance  
 El plato no es suministrado con el aparato  
 Piatto non fornito con l'apparecchio  
 Travessa não fornecida com o aparelho

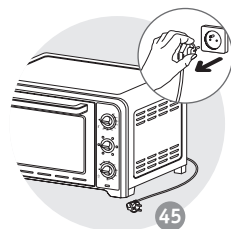
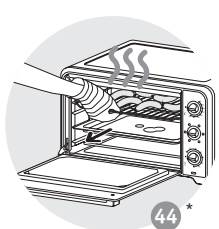
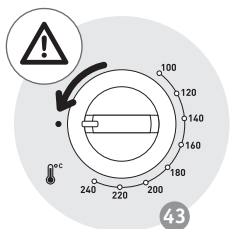
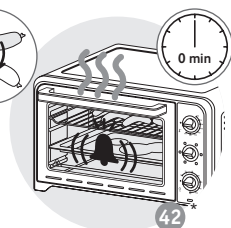
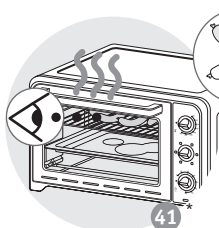
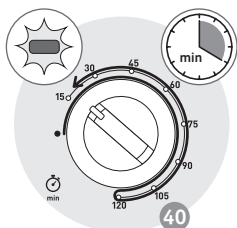
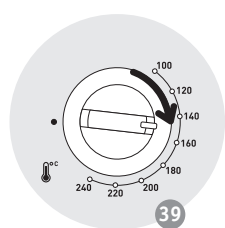
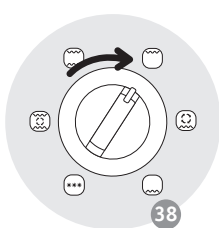
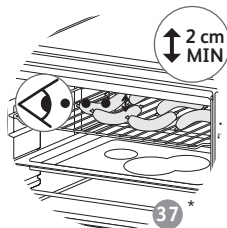
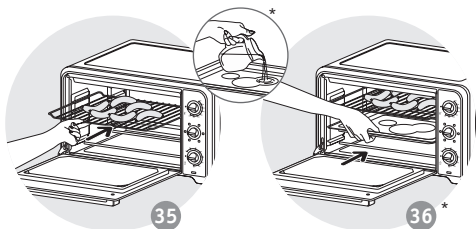
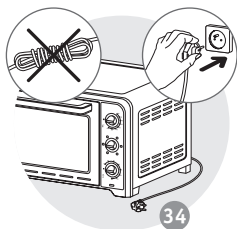

\* selon modèle - afhankelijk van het model - je nach Modell - depending on the model - según el modelo - in base al modello - consoante o modelo



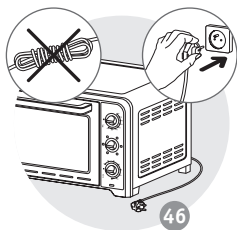

46

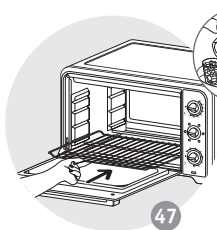

47

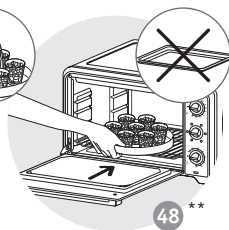

48 \*\*

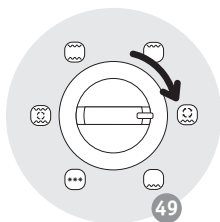

49

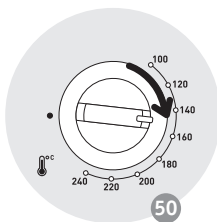

50

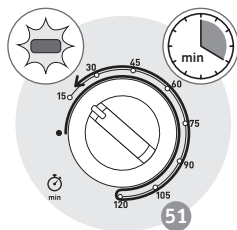

51

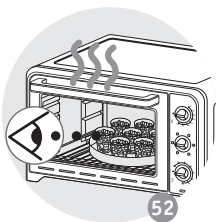

52

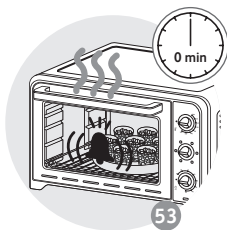

53

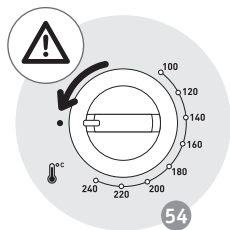

54

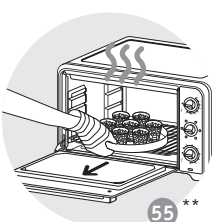

55 \*\*

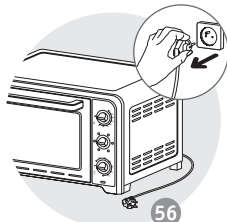

56

\*\* Plat non fourni avec l'appareil  
 Schaal niet bij het apparaat inbegrepen  
 Platte nicht in Lieferumfang inbegriffen  
 The dish is not supplied with the appliance  
 El plato no es suministrado con el aparato  
 Piatto non fornito con l'apparecchio  
 Travessa não fornecida com o aparelho

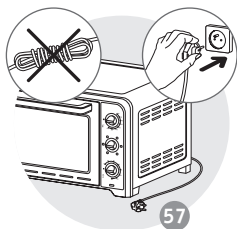

57

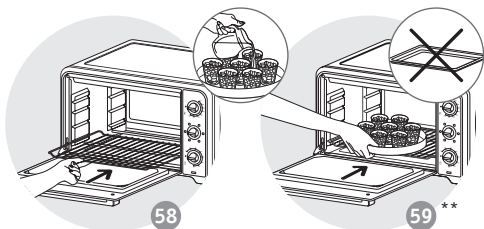

58

59 \*\*

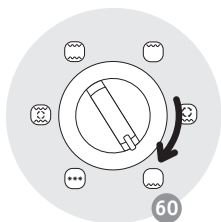

60

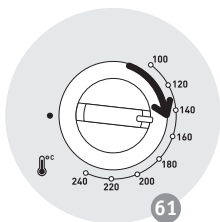

61

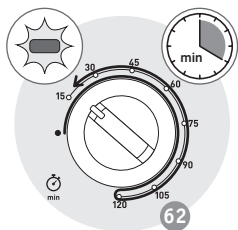

62

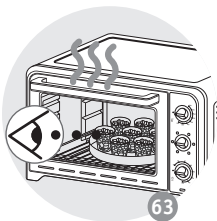

63

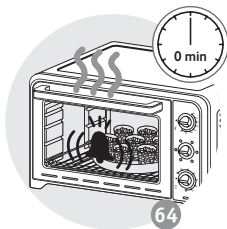

64

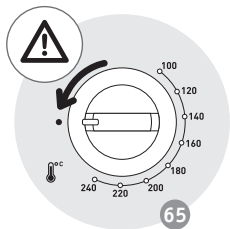

65

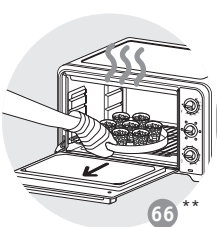

66 \*\*

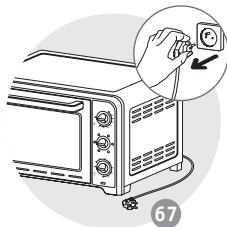

67

\*\* Plat non fourni avec l'appareil  
 Schaal niet bij het apparaat inbegrepen  
 Platte nicht im Lieferumfang inbegriffen  
 The dish is not supplied with the appliance  
 El plato no es suministrado con el aparato  
 Piatto non fornito con l'apparecchio  
 Travessa não fornecida com o aparelho

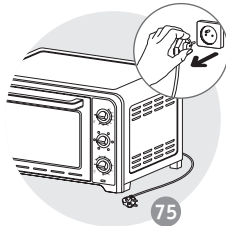
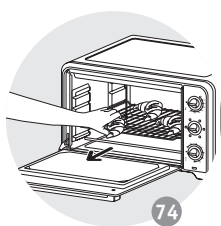
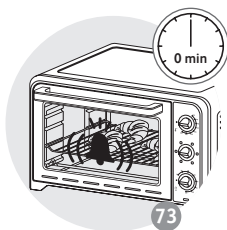
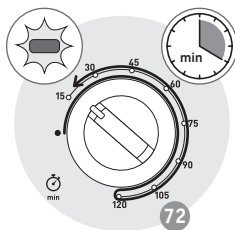
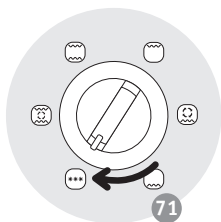
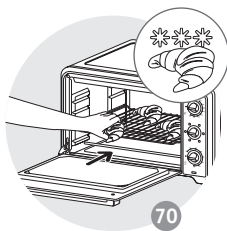
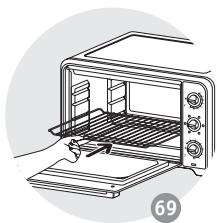
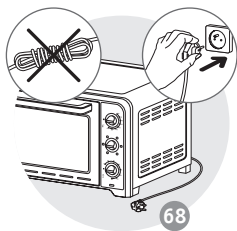

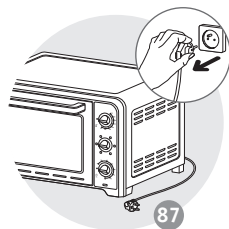
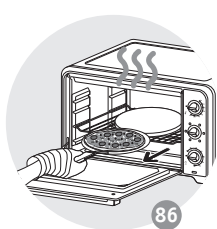
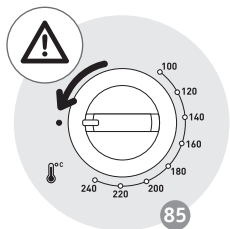
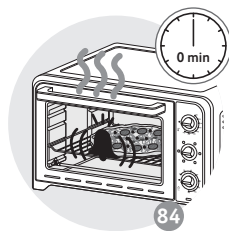
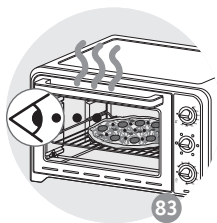
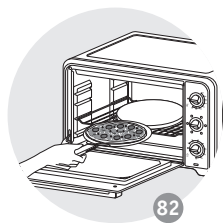
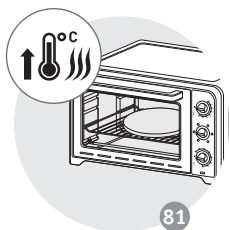
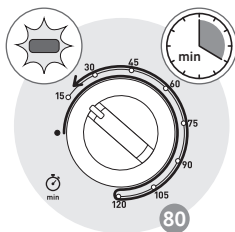
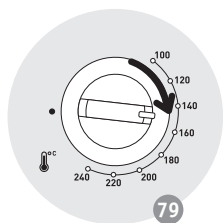
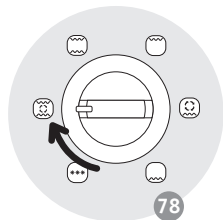
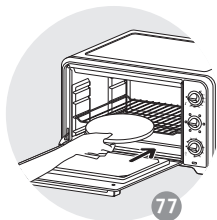
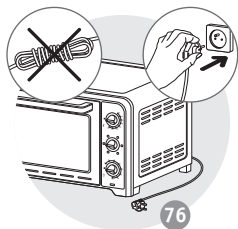

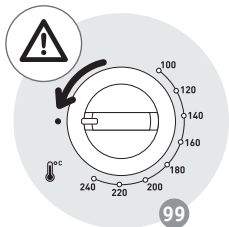
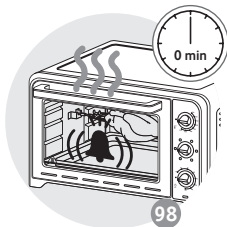
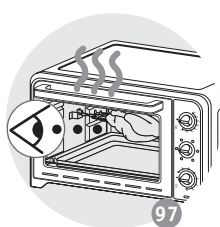
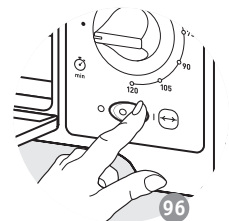
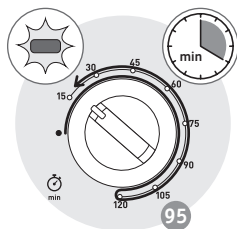
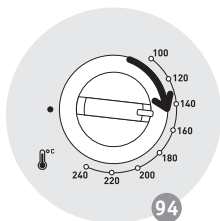
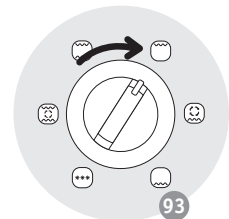
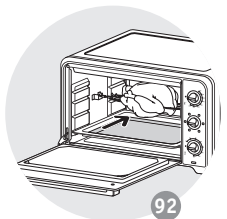
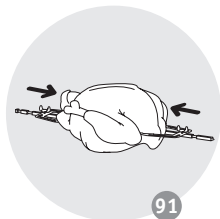
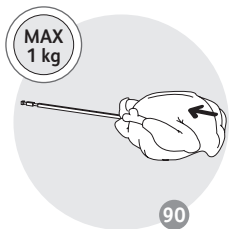
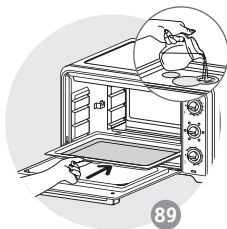
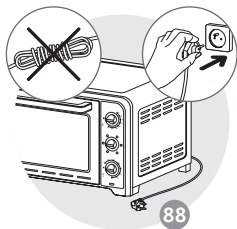

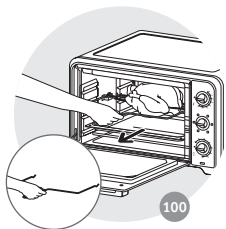

100

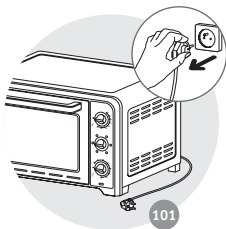

101

10

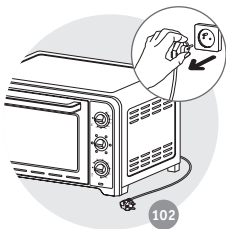

102

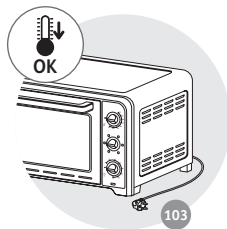

103

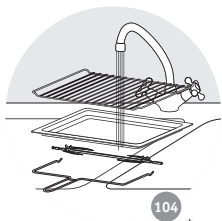

104 \*

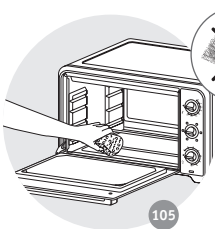

105

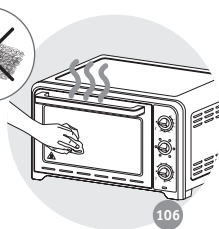

106

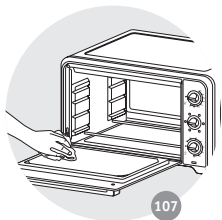

107

\* selon modèle - afhankelijk van het model - je nach Modell - depending on the model - según el modelo - in base al modello - consoante o modelo



	x 4			10 min	240	20
	1,5 Kg			10 min	230	60
	750 g			10 min	240	30
	1 Kg			-	230	85
	x 4		 	-	240	22  +9
	x 8		 	-	240	15  +5
	350 gr			10 min	210	15
				10 min	240	45
	650 gr			10 min	240	20
				-	240	28
				10 min	200	45
				10 min	200	20
				-	135	45
				10 min	230	50
				10 min	240	30
	1,5 Kg			-	240	60

\* selon modèle - afhankelijk van het model - je nach Modell - depending on the model - según el modelo - in base al modello - consoante o modelo

