



## EMC REPORT

Prepared For :	<b>Dongguan Shipai Miao electronic hardware factory</b> Add: No. 9, shaxin 9th street, miaobian wangcun, shipai town, dongguan city, China
Product Name:	NETWOEK CABLE TESTER
Trade Mark:	N/A
Model :	NSS-468
Prepared By :	Shenzhen SIT Testing Technology Co., Ltd. Add: Room 401, A2 Building, The 2rd Industrial Zone of ZhuAo, GuShu Village, XiXiang Town, BaoAn District, ShenZhen, Guangdong, China
Test Date:	November 05, 2019 to November 08, 2019
Date of Report :	November 08, 2019
Report No.:	SIT191105560101ER

**Note:** This report shall not be reproduced except in full, without the written approval of Shenzhen SIT Testing Technology Co., Ltd. This document may be altered or revised by Shenzhen SIT Testing Technology Co., Ltd, personnel only, and shall be noted in the revision section of the document. The test results in the report only apply to the tested sample.

## TABLE OF CONTENTS

<b>1</b>	<b>TEST CERTIFICATION</b>	<b>3</b>
<b>2</b>	<b>TEST RESULT SUMMARY</b>	<b>4</b>
<b>3</b>	<b>EUT DESCRIPTION</b>	<b>5</b>
<b>4</b>	<b>TEST METHODOLOGY</b>	<b>5</b>
4.1.	DECISION OF FINAL TEST MODE	5
4.2.	EUT SYSTEM OPERATION	5
<b>5</b>	<b>SETUP OF EQUIPMENT UNDER TEST</b>	<b>6</b>
5.1.	DESCRIPTION OF SUPPORT UNITS	6
5.2.	CONFIGURATION OF SYSTEM UNDER TEST	6
<b>6</b>	<b>FACILITIES AND ACCREDITATIONS</b>	<b>7</b>
6.1.	FACILITIES	7
6.2.	ACCREDITATIONS	7
6.3.	MEASUREMENT UNCERTAINTY	7
<b>7</b>	<b>EMISSION TEST</b>	<b>8</b>
7.1.	CONDUCTED EMISSION MEASUREMENT	8
7.2.	RADIATED EMISSION MEASUREMENT	11
<b>8</b>	<b>IMMUNITY TEST</b>	<b>16</b>
8.1.	GENERAL DESCRIPTION	16
8.2.	GENERAL PERFORMANCE CRITERIA DESCRIPTION	17
8.3.	ELECTROSTATIC DISCHARGE (ESD)	18
8.4.	RADIATED, RADIO-FREQUENCY, ELECTROMAGNETIC FIELD (RS)	22
8.5.	ELECTRICAL FAST TRANSIENT (EFT)	25
8.6.	SURGE IMMUNITY TEST	28
8.7.	CONDUCTED RADIO FREQUENCY DISTURBANCES (CS)	31
8.8.	POWER FREQUENCY MAGNETIC FIELD	35
8.9.	VOLTAGE DIP & VOLTAGE INTERRUPTIONS	38
<b>9</b>	<b>PHOTOGRAPHS OF THE TEST CONFIGURATION</b>	<b>40</b>
<b>10</b>	<b>PHOTOGRAPHS OF EUT</b>	<b>41</b>

## 1 TEST CERTIFICATION

<b>Product:</b>	NETWOEK CABLE TESTER
<b>Model:</b>	NSS-468
<b>Applicant:</b>	<b>Dongguan Shipai Miao electronic hardware factory</b> Add: No. 9, shaxin 9th street, miaobian wangcun, shipai town, dongguan city, China
<b>Factory:</b>	<b>Dongguan Shipai Miao electronic hardware factory</b> Add: No. 9, shaxin 9th street, miaobian wangcun, shipai town, dongguan city, China
<b>Trade Mark:</b>	N/A
<b>Tested:</b>	November 05, 2019 to November 08, 2019
<b>Test Voltage:</b>	Power supplied by 9V battery
<b>Applicable Standards:</b>	EN 55032:2015 EN 61000-3-2:2019 EN 61000-3-3:2013 EN 55035:2017

The above equipment has been tested by Shenzhen SIT Testing Technology Co., Ltd., and found compliance with the requirements set forth in the technical standards mentioned above. The results of testing in this report apply only to the product/system, which was tested. Other similar equipment will not necessarily produce the same results due to production tolerance and measurement uncertainties.

Prepared by :



Assistant

Reviewer :



Supervisor

Approved &amp; Authorized Signer :



Manager

## 2 TEST RESULT SUMMARY

EMISSION			
Standard	Item	Result	Remarks
EN 55032: 2015	Conducted (Main Port)	N/A	N/A
	Radiated	PASS	Meet Class B limit
EN 61000-3-2:2019	Harmonic current emissions	N/A	N/A
EN 61000-3-3:2013	Voltage fluctuations & flicker	N/A	N/A

IMMUNITY 【EN55035:2017】			
Standard	Item	Result	Remarks
EN 61000-4-2:2009	ESD	PASS	Meets the requirements of Performance Criterion B
EN 61000-4-3:2006+A1:2008+A2:2010	RS	PASS	Meets the requirements of Performance Criterion A
EN 61000-4-4:2012	EFT	N/A	Meets the requirements of Performance Criterion B
EN 61000-4-5:2014+A1:2017	Surge	N/A	Meets the requirements of Performance Criterion B
EN 61000-4-6:2014	CS	N/A	Meets the requirements of Performance Criterion A
EN 61000-4-8: 2010	PFMF	N/A	Meets the requirements of Performance Criterion A
EN 61000-4-11:2004+A1:2017	Voltage dips & voltage variations	N/A	Meets the requirements of <b>Voltage dips:</b> 1) >95% reduction performance Criterion B 2) 30% reduction performance Criterion C <b>Voltage variations:</b> 1)>95% reduction performance Criterion C

- Note:**
1. The test result judgment is decided by the limit of test standard
  2. The information of measurement uncertainty is available upon the customer's request.

### 3 EUT DESCRIPTION

<b>Product</b>	NETWOEK CABLE TESTER
<b>Model</b>	NSS-468
<b>Trade Mark</b>	N/A
<b>Applicant</b>	Dongguan Shipai Miao electronic hardware factory
<b>Housing material</b>	Plastic
<b>EUT Type</b>	<input checked="" type="checkbox"/> Engineering Sample. <input type="checkbox"/> Product Sample, <input type="checkbox"/> Mass Product Sample.
<b>Serial Number</b>	N/A
<b>Power Rating</b>	Power supplied by 9V battery

## 4 TEST METHODOLOGY

### 4.1. DECISION OF FINAL TEST MODE

The EUT was tested together with the thereafter additional components, and a configuration, which produced the worst emission levels, was selected and recorded in this report.

The following test mode(s) were scanned during the preliminary test:

Pre-Test Mode		
Mode Emission	Radiated Emission	Normal working

After the preliminary scan, the following test mode was found to produce the highest emission level.

The Worst Test Mode		
Mode Emission	Radiated Emission	Normal working

### 4.2. EUT SYSTEM OPERATION

1. Set up EUT with the support equipments.
2. Make sure the EUT work normally during the test.

## 5 SETUP OF EQUIPMENT UNDER TEST

### 5.1. DESCRIPTION OF SUPPORT UNITS

The EUT has been tested as an independent unit together with other necessary accessories or support units. The following support units or accessories were used to form a representative test configuration during the tests.

**Note:**

- 1) All the equipment/cables were placed in the worst-case configuration to maximize the emission during the test.
- 2) Grounding was established in accordance with the manufacturer's requirements and conditions for the intended use.

### 5.2. CONFIGURATION OF SYSTEM UNDER TEST



(EUT: NETWORK CABLE TESTER)

## 6 FACILITIES AND ACCREDITATIONS

### 6.1. FACILITIES

All measurement facilities used to collect the measurement data are located at SIT LAB.

The sites are constructed in conformance with the requirements of ANSI C63.4 and CISPR Publication 22. All receiving equipment conforms to CISPR Publication 16-1, "Radio Interference Measuring Apparatus and Measurement Methods."

### 6.2. ACCREDITATIONS

Our laboratories are accredited and approved by the following approval agencies according to ISO/IEC 17025.

Copies of granted accreditation certificates are available for downloading from our web site, [www.sit-cert.com](http://www.sit-cert.com)

### 6.3. MEASUREMENT UNCERTAINTY

Where relevant, the following measurement uncertainty levels have been estimated for tests performed on the EUT as specified in CISPR 16-4-2:

Measurement	Frequency		Uncertainty
Conducted emissions	9kHz~30MHz		+/- 3.59dB
Radiated emissions	Horizontal	30MHz ~ 200MHz	+/- 4.77dB
		200MHz ~1000MHz	+/- 4.93dB
	Vertical	30MHz ~ 200MHz	+/- 5.04dB
		200MHz ~1000MHz	+/- 4.93dB

This uncertainty represents an expanded uncertainty expressed at approximately the 95% confidence level using a coverage factor of k=2.

## 7 EMISSION TEST

### 7.1. CONDUCTED EMISSION MEASUREMENT

#### 7.1.1. LIMITS

FREQUENCY (MHz)	Class B (dBuV)	
	Quasi-peak	Average
0.15 - 0.5	66 - 56	56 - 46
0.50 - 5.0	56	46
5.0 - 30.0	60	50

**NOTE:**

- (1) The lower limit shall apply at the transition frequencies.
- (2) The limit decreases in line with the logarithm of the frequency in the range of 0.15 to 0.50 MHz.
- (3) All emanations from a class A/B digital device or system, including any network of conductors and apparatus connected thereto, shall not exceed the level of field strengths specified above.

#### 7.1.2. TEST INSTRUMENTS

Conducted Emission Shielding Room Test Site (743)				
Name of Equipment	Manufacturer	Model	Serial Number	Calibration Due
EMI Test Receiver	R&S	ESCI	100005	03/14/2020
LISN	AFJ	LS16	16010222119	03/19/2020
LISN(EUT)	Mestec	AN3016	04/10040	03/18/2020

- NOTE:**
1. The calibration interval of the above test instruments is 12 months and the calibrations are traceable to international system unit (SI).
  2. N.C.R = No Calibration Request.



### **7.1.3. TEST PROCEDURES**

#### **Procedure of Preliminary Test**

The EUT and Support equipment, if needed, was set up as per the test configuration to simulate typical usage per the user's manual. When the EUT is a tabletop system, a wooden table with a height of 0.8 meters is used and is placed on the ground plane as per EN55032 (see Test Facility for the dimensions of the ground plane used). When the EUT is a floor standing equipment, it is placed on the ground plane, which has a 3-12 mm non-conductive covering to insulate the EUT from the ground plane.

All I/O cables were positioned to simulate typical actual usage as per EN55032.

The EUT test program was started. Emissions were measured on each current carrying line of the EUT using an EMI Test Receiver connected to the LISN powering the EUT.

The Receiver scanned from 150 kHz to 30MHz for emissions in each of the test modes.

During the above scans, the emissions were maximized by cable manipulation.

The test mode(s) described in Item 3.1 were scanned during the preliminary test.

After the preliminary scan, we found the test mode described in Item 3.1 producing the highest emission level.

The EUT configuration and cable configuration of the above highest emission levels were recorded for reference of the final test.

#### **Procedure of Final Test**

EUT and support equipment were set up on the test bench as per the configuration with highest emission level in the preliminary test.

A scan was taken on both power lines, Line 1 and Line 2, recording at least the six highest emissions. Emission frequency and amplitude were recorded into a computer in which correction factors were used to calculate the emission level and compare reading to the applicable limit.

The test data of the worst-case condition(s) was recorded.

**7.1.4. TEST SETUP**

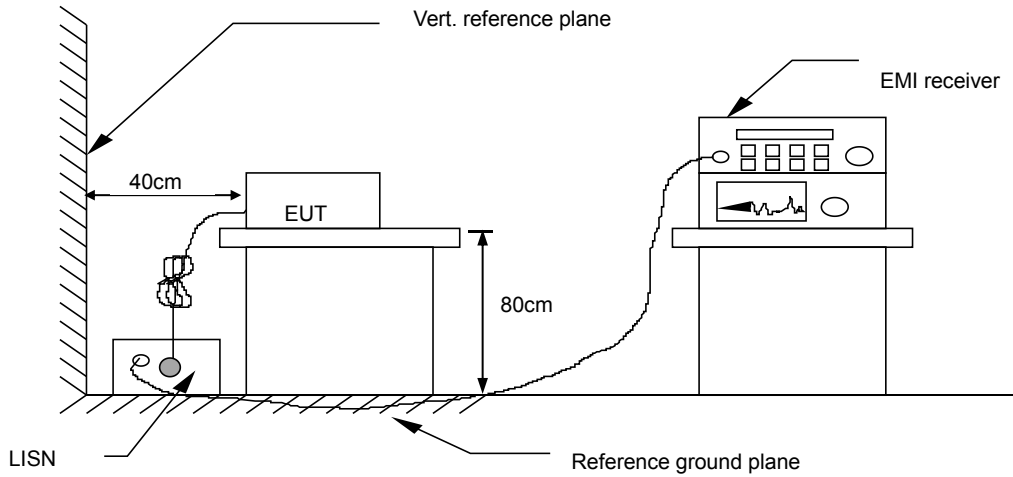

For the actual test configuration, please refer to the related item – Photographs of the Test Configuration.

**7.1.5. TEST RESULTS**

<b>Model No.</b>	NSS-468	<b>6dB Bandwidth</b>	10 KHz
<b>Environmental Conditions</b>	26°C, 60% RH	<b>Test Mode</b>	N/A
<b>Detector Function</b>	Peak / Quasi-peak/AV	<b>Test Result</b>	N/A
<b>Test By</b>	DebeYu		

**NOTE:**

L1 = Line One (Live Line) / L2 = Line Two (Neutral Line).

“---” denotes the emission level was or more than 2dB below the Average limit, so no re-check anymore.

Freq. = Emission frequency in MHz

Reading level (dBUV) = Receiver reading

Corr. Factor (dB) = Attenuator factor + Cable loss

Level (dBUV) = Reading level (dBUV) + Corr. Factor (dB)

Limit (dBUV) = Limit stated in standard

Margin (dB) = Level (dBUV) – Limits (dBUV)

Q.P.=Quasi-Peak

## 7.2. RADIATED EMISSION MEASUREMENT

### 7.2.1. LIMITS

FREQUENCY (MHz)	dBuV/m (At 3m)
	Limit
30 ~ 230	40
230 ~ 1000	47

**NOTE:** (1) The lower limit shall apply at the transition frequencies.  
 (2) Emission level (dBuV/m) = 20 log Emission level (uV/m).

### 7.2.2. TEST INSTRUMENTS

Radiated Emission Test Site (966)				
Name of Equipment	Manufacturer	Model	Serial Number	Calibration Due
EMI Test Receiver	R&S	ESCI	100005	03/14/2020
Spectrum Analyzer	R&S	FSU	100114	03/17/2020
Pre Amplifier	H.P.	HP8447E	2945A02715	03/14/2020
Bilog Antenna	SUNOL Sciences	JB3	A021907	03/17/2020
Cable	TIME MICROWAVE	LMR-400	N-TYPE04	03/19/2020
System-Controller	CCS	N/A	N/A	N.C.R
Turn Table	CCS	N/A	N/A	N.C.R
Antenna Tower	CCS	N/A	N/A	N.C.R

**NOTE:** 1. The calibration interval of the above test instruments is 12 months and the calibrations are traceable to international system unit (SI).  
 2. N.C.R = No Calibration Request.

### **7.2.3. TEST PROCEDURE**

#### **Procedure of Preliminary Test**

The equipment was set up as per the test configuration to simulate typical usage per the user's manual. When the EUT is a tabletop system, a wooden turntable with a height of 0.8 meters is used which is placed on the ground plane. When the EUT is a floor standing equipment, it is placed on the ground plane which has a 3-12 mm non-conductive covering to insulate the EUT from the ground plane.

Support equipment, if needed, was placed as per EN55032.

All I/O cables were positioned to simulate typical usage as per EN55032.

Mains cables, telephone lines or other connections to auxiliary equipment located outside the test are shall drape to the floor, be fitted with ferrite clamps or ferrite tubes placed on the floor at the point where the cable reaches the floor and then routed to the place where they leave the turntable. No extension cords shall be used to mains receptacle.

The antenna was placed at 3 meter away from the EUT as stated in EN 55032. The antenna connected to the Spectrum Analyzer via a cable and at times a pre-amplifier would be used.

The Analyzer / Receiver quickly scanned from 30MHz to 1000MHz. The EUT test program was started. Emissions were scanned and measured rotating the EUT to 360 degrees and positioning the antenna 1 to 4 meters above the ground plane, in both the vertical and the horizontal polarization, to maximize the emission reading level.

The test mode(s) described in Item 3.1 were scanned during the preliminary test:

After the preliminary scan, we found the test mode described in Item 3.1 producing the highest emission level. The EUT and cable configuration, antenna position, polarization and turntable position of the above highest emission level were recorded for the final test.

#### **Procedure of Final Test**

EUT and support equipment were set up on the turntable as per the configuration with highest emission level in the preliminary test.

The Analyzer / Receiver scanned from 30MHz to 1000MHz. Emissions were scanned and measured rotating the EUT to 360 degrees, varying cable placement and positioning the antenna 1 to 4 meters above the ground plane, in both the vertical and the horizontal polarization, to maximize the emission reading level.

Recorded at least the six highest emissions. Emission frequency, amplitude, antenna position, polarization and turntable position were recorded into a computer in which correction factors were used to calculate the emission level and compare reading to the applicable limit and only Q.P. reading is presented.

The test data of the worst-case condition(s) was recorded.

**7.2.4. TEST SETUP**

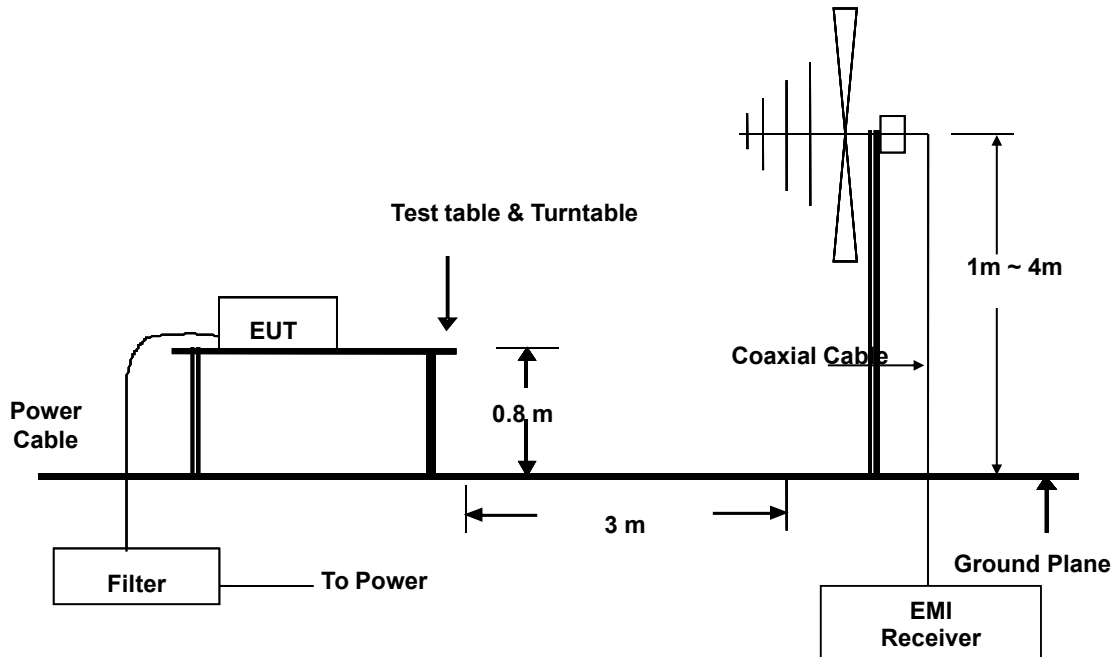

For the actual test configuration, please refer to the related item – Photographs of the Test Configuration

**7.2.5 TEST RESULTS**

<b>Model No.</b>	NSS-468	<b>Test Mode</b>	Normal working
<b>Environmental Conditions</b>	26°C, 60% RH	<b>6dB Bandwidth</b>	120 KHz
<b>Antenna Pole</b>	Vertical / Horizontal	<b>Antenna Distance</b>	3m
<b>Detector Function</b>	Peak / Quasi-peak	<b>Tested by</b>	DebeYu

Freq. = Emission frequency in MHz

Reading level (dBuV) = Receiver reading

Corr. Factor (dB) = Antenna factor + Cable loss

Measurement (dBuV) = Reading level (dBuV) + Corr. Factor (dB)

Limit (dBuV) = Limit stated in standard

Margin (dB) = Measurement (dBuV) – Limits (dBuV)

**Radiated Emission Measurement**

File :1106

Data :#27

Date: 2019/11/06

Time: 16:08:29

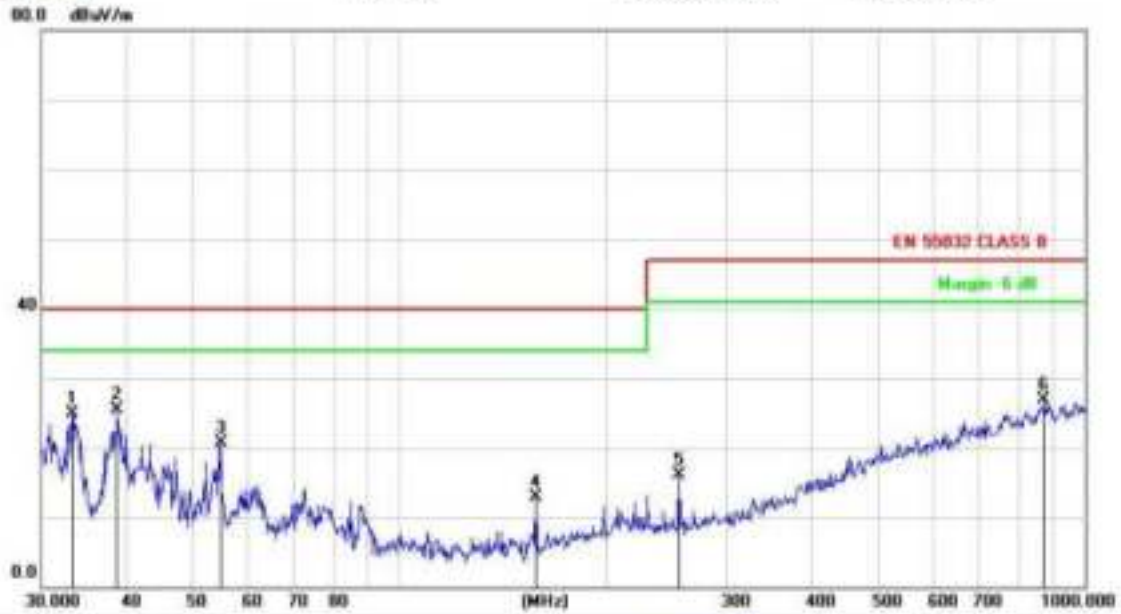

Limit: EN 55032 CLASS B  
 EUT: NETWORK CABLE TESTER  
 M/N:  
 Mode: NSS-468  
 Note:

Polarization: *Vertical*      Temperature:  
 Power:                                  Humidity: %  
 Distance: 3m

No.	Mk.	Freq. MHz	Reading Level dBuV	Correct Factor dB	Measure- ment dBuV/m	Limit dB/m	Over dB	Detector	Antenna Height cm	Table Degree degree	Comment
1		33.3279	40.25	-15.33	24.92	40.00	-15.08	peak			
2	*	38.7518	39.23	-13.81	25.42	40.00	-14.58	peak			
3		54.8348	36.86	-16.10	20.76	40.00	-19.24	peak			
4		158.1123	29.20	-16.37	12.83	40.00	-27.17	peak			
5		255.6231	33.60	-17.49	16.11	47.00	-30.89	peak			
6		872.1832	29.19	-2.21	26.98	47.00	-20.02	peak			

**Radiated Emission Measurement**

File: 1106

Data: #28

Date: 2019/11/05

Time: 16:09:26

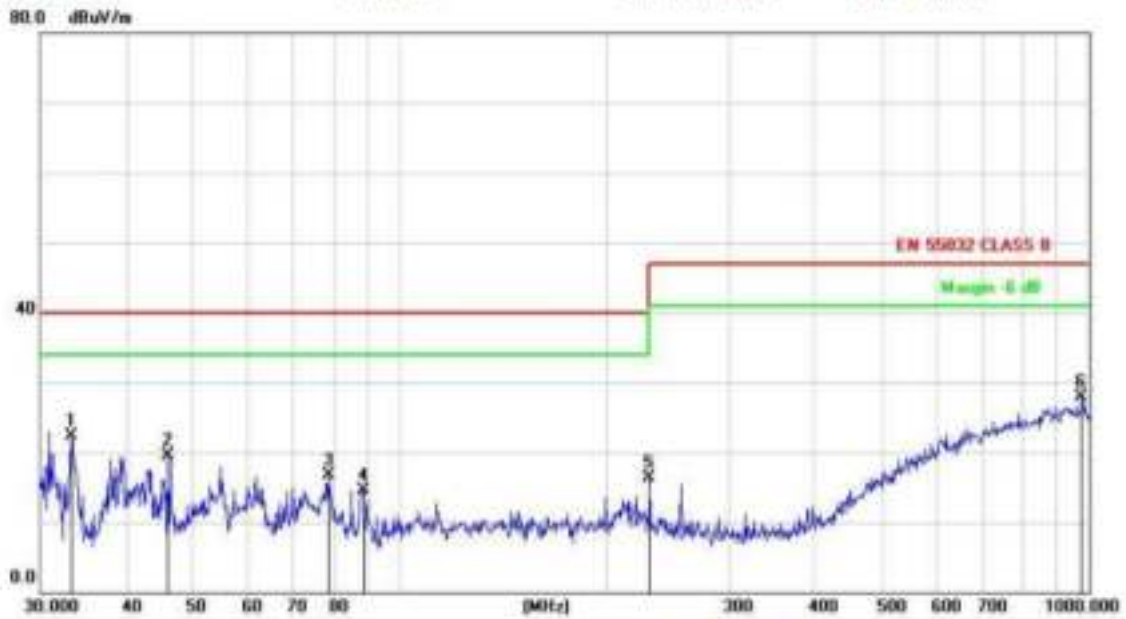

Limit: EN 55032 CLASS B  
 EUT: NETWORK CABLE TESTER  
 M/N:  
 Model: NSS-468  
 Note:

Polarization: *Horizontal*      Temperature:  
 Power:                                  Humidity: %  
 Distance: 3m

No.	Mk.	Freq. MHz	Reading Level dBuV	Correct Factor dB	Measure- ment dBuV/m	Limit dBm	Over dB	Antenna Height cm	Table Degree	Detector	Comment
1	*	33.3279	40.90	-18.67	22.23	40.00	-17.77			peak	
2		46.0164	34.09	-14.60	19.49	40.00	-20.51			peak	
3		78.6888	34.31	-17.63	16.68	40.00	-23.32			peak	
4		88.3421	33.23	-18.67	14.56	40.00	-25.44			peak	
5		230.0985	29.80	-13.41	16.39	47.00	-30.61			peak	
6		975.7529	27.90	-0.04	27.86	47.00	-19.14			peak	

## 8 IMMUNITY TEST

### 8.1. GENERAL DESCRIPTION

Product Standard	EN55035:2017	
	Test Type	Minimum Requirement
Basic Standard, Specification, and Performance Criterion required	EN 61000-4-2	Electrostatic Discharge – ESD: 8kV air discharge, 4kV Contact discharge, Performance Criterion B
	EN 61000-4-3	Radio-Frequency Electromagnetic Field Susceptibility Test – RS: 80 ~1000 MHz, 3V/m, 80% AM(1kHz), Performance Criterion A
	EN 61000-4-4	Electrical Fast Transient/Burst - EFT, Power line: 1kV, Signal line: 0.5kV, Performance Criterion B
	EN 61000-4-5	Surge Immunity Test: 1.2/50 us Open Circuit Voltage, 8 /20 us Short Circuit Current, Power Port ~ Line to line: 1kV, Line to ground: 2kV Signal Port ~ Lines to ground : 1kV Performance Criterion B
	EN 61000-4-6	Conducted Radio Frequency Disturbances Test –CS: 0.15 ~ 80 MHz, 3Vrms, 80% AM, 1kHz, Performance Criterion A
	EN 61000-4-8	Power frequency magnetic field immunity test 50 Hz, 1A/m Performance Criterion A
	EN 61000-4-11	Voltage Dips: i) >95% reduction for 0.5 period, Performance Criterion B ii) 30% reduction for 25 period, Performance Criterion C Voltage Interruptions: >95% reduction for 250 period Performance Criterion C



## 8.2. GENERAL PERFORMANCE CRITERIA DESCRIPTION

<p><b>Criteria A:</b></p>	<p>The apparatus shall continue to operate as intended without operator intervention. No degradation of performance or loss of function is allowed below a performance level specified by the manufacturer, when the apparatus is used as intended. The performance level may be replaced by a permissible loss of performance. If the manufacturer does not specify the minimum performance level or the permissible performance loss, then either of these may be derived from the product description and documentation, and by what the user may reasonably expect from the equipment if used as intended.</p>
<p><b>Criteria B:</b></p>	<p>After test, the apparatus shall continue to operate as intended without operator intervention. No degradation of performance or loss of function is allowed, after the application of the phenomenon below a performance level specified by the manufacturer, when the apparatus is used as intended. The performance level may be replaced by a permissible loss of performance.</p> <p>During the test, degradation of performance is however allowed. However, no change of operating state if stored data is allowed to persist after the test. If the manufacturer does not specify the minimum performance level or the permissible performance loss, then either of these may be derived from the product description and documentation, and by what the user may reasonably expect from the equipment if used as intended.</p>
<p><b>Criteria C:</b></p>	<p>Temporary loss of function is allowed, provided the functions is self-recoverable or can be restored by the operation of controls by the user in accordance with the manufacturer instructions.</p> <p>Functions, and/or information stored in non-volatile memory, or protected by a battery backup, shall not be lost.</p>

### 8.3. ELECTROSTATIC DISCHARGE (ESD)

#### 8.3.1. TEST SPECIFICATION

<b>Basic Standard:</b>	EN 61000-4-2
<b>Discharge Impedance:</b>	330 ohm
<b>Normal working Capacity:</b>	150pF
<b>Discharge Voltage:</b>	Air Discharge: 8 kV (Direct) Contact Discharge: 4 kV (Direct/Indirect)
<b>Polarity:</b>	Positive & Negative
<b>Number of Discharge:</b>	Minimum 25 times at each test point
<b>Discharge Mode:</b>	1 time/s
<b>Performance Criterion:</b>	B

#### 8.3.2. TEST INSTRUMENT

IMMUNITY SHIELDED ROOM				
Name of Equipment	Manufacturer	Model	Serial Number	Calibration Due
ESD 2000	EMC PARTNER	ESD2000	182	03/13/2020

**NOTE:** The calibration interval of the above test instruments is 12 months and the calibrations are traceable to international system unit (SI).

### 8.3.3. TEST PROCEDURE

The discharges shall be applied in two ways:

- a) Contact discharges to the conductive surfaces and coupling planes:  
The EUT shall be exposed to at least 200 discharges, 100 each at negative and positive polarity, at a minimum of four test points. One of the test points shall be subjected to at least 50 indirect discharges to the center of the front edge of the **Horizontal Coupling Plane (HCP)**. The remaining three test points shall each receive at least 50 direct contact discharges. If no direct contact test points are available, then at least 200 indirect discharges shall be applied in the indirect mode. Test shall be performed at a maximum repetition rate of one discharge per second.
- b) Air discharges at slots and apertures and insulating surfaces:  
On those parts of the EUT where it is not possible to perform contact discharge testing, the equipment should be investigated to identify user accessible points where breakdown may occur. Such points are tested using the air discharge method. This investigation should be restricted to those area normally handled by the user. A minimum of 10 single air discharges shall be applied to the selected test point for each such area.

The basic test procedure was in accordance with IEC 61000-4-2:

- a) The EUT was located 0.1 m minimum from all side of the **HCP** (dimensions 1.6m x 0.8m).
- b) The support units were located another table 30 cm away from the EUT, but direct support unit was/were located at same location as EUT on the HCP and keep at a distance of 10 cm with EUT.
- c) The time interval between two successive single discharges was at least 1 second.
- d) Contact discharges were applied to the non-insulating coating, with the pointed tip of the generator penetrating the coating and contacting the conducting substrate.
- e) Air discharges were applied with the round discharge tip of the discharge electrode approaching the EUT as fast as possible (without causing mechanical damage) to touch the EUT. After each discharge, the ESD generator was removed from the EUT and re-triggered for a new single discharge. The test was repeated until all discharges were complete.
- f) At least ten single discharges (in the most sensitive polarity) were applied at the front edge of each **HCP** opposite the center point of each unit of the EUT and 0.1 meters from the front of the EUT. The long axis of the discharge electrode was in the plane of the **HCP** and perpendicular to its front edge during the discharge.
- g) At least ten single discharges (in the most sensitive polarity) were applied to the center of one vertical edge of the **Vertical Coupling Plane (VCP)** in sufficiently different positions that the four faces of the EUT were completely illuminated. The **VCP** (dimensions 0.5m x 0.5m) was placed vertically to and 0.1 meters from the EUT.

**8.3.4. TEST SETUP**

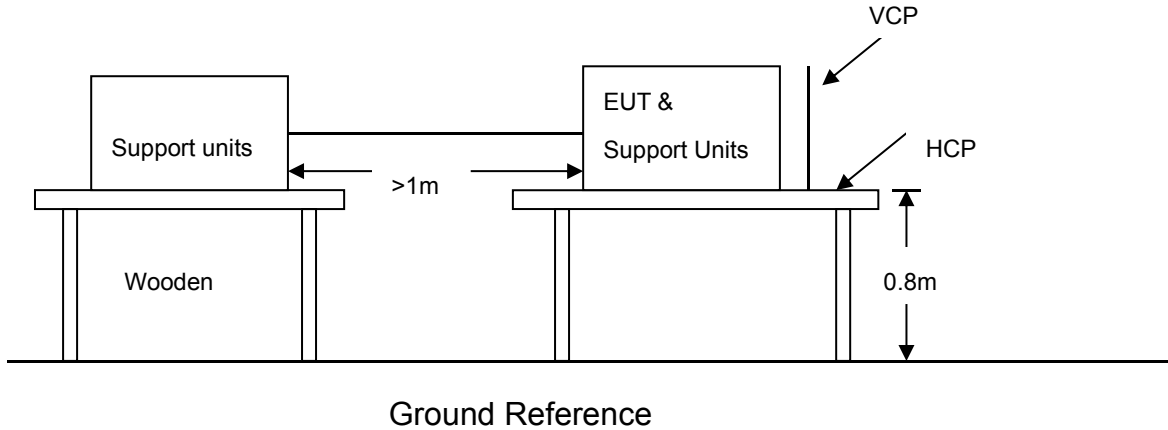

For the actual test configuration, please refer to the related item – Photographs of the Test Configuration.

**NOTE:**

TABLE-TOP EQUIPMENT

The configuration consisted of a wooden table 0.8 meters high standing on the **Ground Reference Plane**. The **GRP** consisted of a sheet of aluminum at least 0.25mm thick, and 2.5 meters square connected to the protective grounding system. A **Horizontal Coupling Plane** (1.6m x 0.8m) was placed on the table and attached to the **GRP** by means of a cable with 940k total impedance. The equipment under test, was installed in a representative system as described in section 7 of EN 61000-4-2, and its cables were placed on the **HCP** and isolated by an insulating support of 0.5mm thickness. A distance of 1-meter minimum was provided between the EUT and the walls of the laboratory and any other metallic structure.

FLOOR-STANDING EQUIPMENT

The equipment under test was installed in a representative system as described in section 7 of IEC 61000-4-2, and its cables were isolated from the Ground Reference Plane by an insulating support of 0.1-meter thickness. The **GRP** consisted of a sheet of aluminum that is at least 0.25mm thick, and 2.5 meters square connected to the protective grounding system and extended at least 0.5 meters from the EUT on all sides.

**8.3.5. TEST RESULTS**

<b>Temperature:</b>	25°C	<b>Humidity</b>	55% RH
<b>Pressure</b>	996mbar	<b>Test result</b>	Pass
<b>Test mode</b>	Normal working	<b>Test By</b>	DebeYu

Air Discharge						
Test locations	Test Levels	Results				
		± 8 kV	Pass	Fail	Performance Criterion	Observation
Button and Top	2Points	<input checked="" type="checkbox"/>	<input checked="" type="checkbox"/>	<input type="checkbox"/>	<b>B</b>	Note <input type="checkbox"/> 1 <input checked="" type="checkbox"/> 2

Contact Discharge						
Test Points	Test Levels	Results				
		± 4 kV	Pass	Fail	Performance Criterion	Observation
HCP	2Points	<input checked="" type="checkbox"/>	<input checked="" type="checkbox"/>	<input type="checkbox"/>	<b>B</b>	Note <input type="checkbox"/> 1 <input checked="" type="checkbox"/> 2
VCP	2Points	<input checked="" type="checkbox"/>	<input checked="" type="checkbox"/>	<input type="checkbox"/>	<b>B</b>	Note <input type="checkbox"/> 1 <input checked="" type="checkbox"/> 2

**NOTE:** 1. There was no change compared with initial operation during the test.  
 2. The loss of function of the EUT during the test and it was recovered by itself operation after the test.

### 8.4. RADIATED, RADIO-FREQUENCY, ELECTROMAGNETIC FIELD (RS)

<b>Basic Standard:</b>	EN 61000-4-3
<b>Frequency Range:</b>	80 MHz ~1000 MHz,
<b>Field Strength:</b>	3 V/m
<b>Modulation:</b>	1kHz Sine Wave, 80%, AM Modulation
<b>Frequency Step:</b>	1 % of preceding frequency value
<b>Polarity of Antenna:</b>	Horizontal and Vertical
<b>Test Distance:</b>	3 m
<b>Antenna Height:</b>	1.5m
<b>Performance Criterion:</b>	A

#### 8.4.2. TEST INSTRUMENT

743 RS Chamber				
Name of Equipment	Manufacturer	Model	Serial Number	Calibration Due
Signal Generator	Maconi	2022D	119246/003	03/19/2020
Power Amplifier	M2S	A00181-1000	9801-112	03/19/2020
Power Amplifier	M2S	AC8113/ 800-250A	9801-179	03/19/2020
Power Antenna	SCHAFFNER	CBL6140A	1204	03/19/2020

**NOTE:** 1. The calibration interval of the above test instruments is 12 months and the calibrations are traceable to international system unit (SI).  
 2. N.C.R.= No Calibration required

#### 8.4.3. TEST PROCEDURE

The test procedure was in accordance with EN 61000-4-3

- a) The testing was performed in a fully anechoic chamber. The transmit antenna was located at a distance of 3 meters from the EUT.
- b) The frequency range is swept from 80 MHz to 1000 MHz, with the signal 80% amplitude modulated with a 1 kHz sine-wave. The rate of sweep did not exceed  $1.5 \times 10^{-3}$  decade/s, where the frequency range is swept incrementally, the step size was 1% of preceding frequency value.
- c) The dwell time at each frequency shall be not less than the time necessary for the EUT to be able to respond.
- d) The test was performed with the EUT exposed to both vertically and horizontally polarized fields on each of the four sides.

### 8.4.4. TEST SETUP

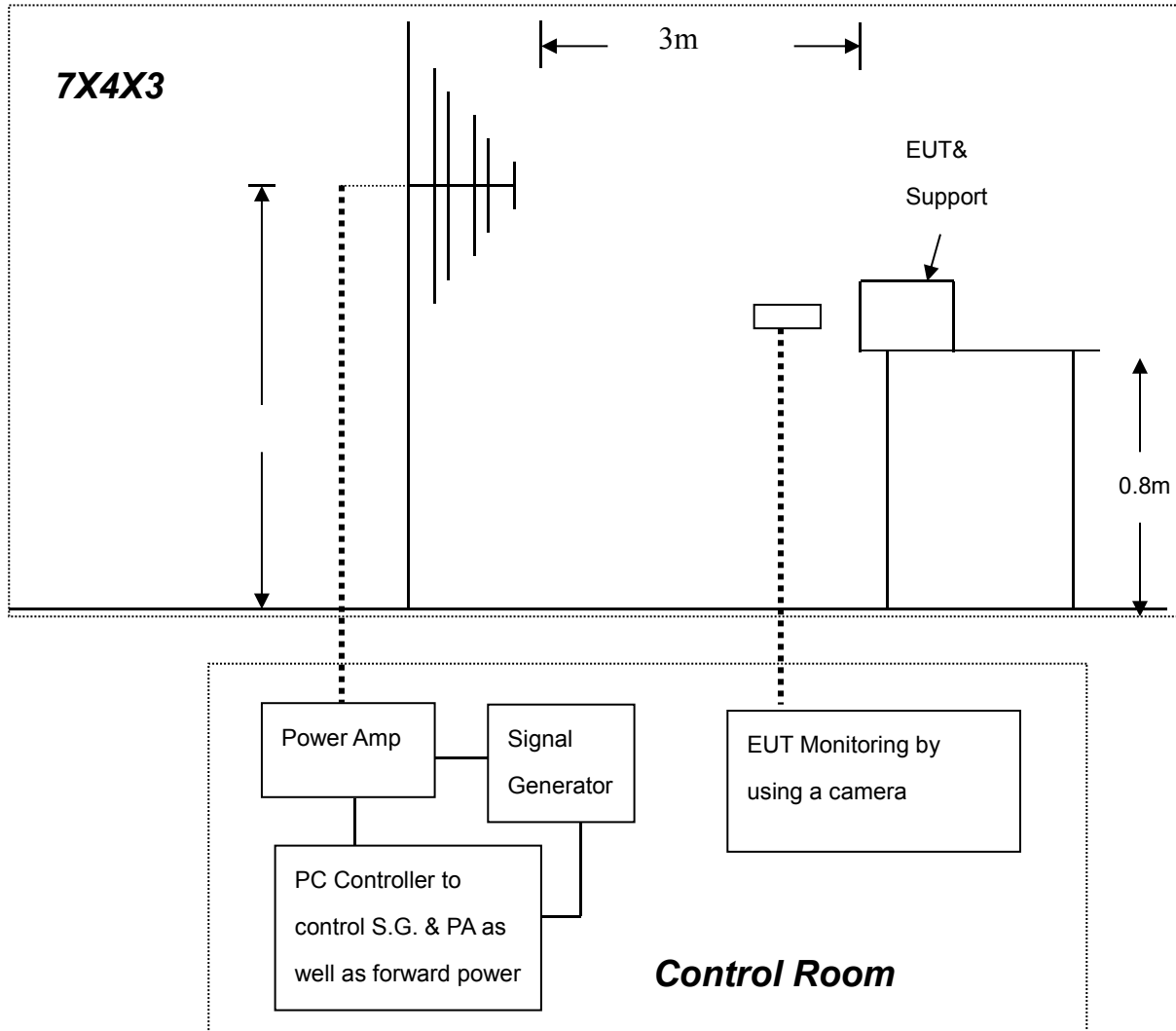

For the actual test configuration, please refer to the related item.

**NOTE:**

TABLETOP EQUIPMENT

The EUT installed in a representative system as described in section 7 of EN 61000-4-3 was placed on a non-conductive table 0.8 meters in height. The system under test was connected to the power and signal wire according to relevant installation instructions.

FLOOR STANDING EQUIPMENT

The EUT installed in a representative system as described in section 7 of IEC 61000-4-3 was placed on a non-conductive wood support 0.1 meters in height. The system under test was connected to the power and signal wire according to relevant installation instructions.

### 8.4.5. TEST RESULTS

<b>Temperature:</b>	25°C	<b>Humidity</b>	55% RH
<b>Pressure</b>	996mbar	<b>Test result</b>	Pass
<b>Test mode</b>	Normal working	<b>Test By</b>	DebeYu

Frequency (MHz)	Polarity	Position	Field Strength (V/m)	Observation	Result
80 ~ 1000	V&H	Front	3	Note	PASS
80 ~ 1000	V&H	Rear	3	Note	PASS
80 ~ 1000	V&H	Left	3	Note	PASS
80 ~ 1000	V&H	Right	3	Note	PASS

**NOTE:** 1. There was no change compared with the initial operation during the test.



## 8.5. ELECTRICAL FAST TRANSIENT (EFT)

### 8.5.1. TEST SPECIFICATION

<b>Basic Standard:</b>	EN 61000-4-4
<b>Test Voltage:</b>	Power Line: 1 kV Signal/Control Line: 0.5 kV
<b>Polarity:</b>	Positive & Negative
<b>Impulse Frequency:</b>	5 kHz
<b>Impulse Wave-shape:</b>	5/50 ns
<b>Burst Duration:</b>	15 ms
<b>Burst Period:</b>	300 ms
<b>Test Duration:</b>	Not less than 1 min.
<b>Performance criterion:</b>	B

### 8.5.2. TEST INSTRUMENT

Immunity Shield Room				
Name of Equipment	Manufacturer	Model	Serial Number	Calibration Due
EMC PARTNER TRANSIENT 2000	EMC PARTNER	TRA2000	881	03/13/2020

**NOTE:** 1. The calibration interval of the above test instruments is 12 months and the calibrations are traceable to international system unit (SI).

2. N.C.R.= No Calibration required

### 8.5.3. TEST PROCEDURE

- Both positive and negative polarity discharges were applied.
- The length of the "hot wire" from the coaxial output of the EFT generator to the terminals on the EUT should not exceed 1 meter.
- The duration time of each test sequential was 1 minute.
- The transient/burst waveform was in accordance with EN 61000-4-4, 5/50ns.

**8.5.4. TEST SETUP**

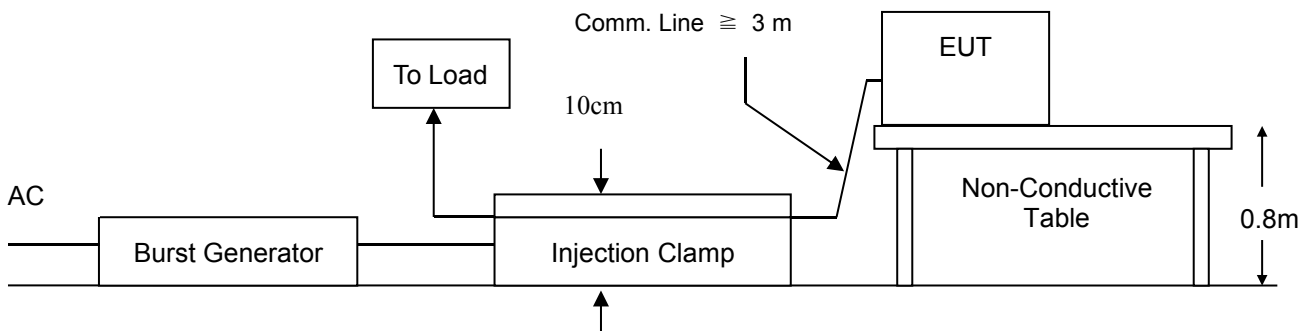
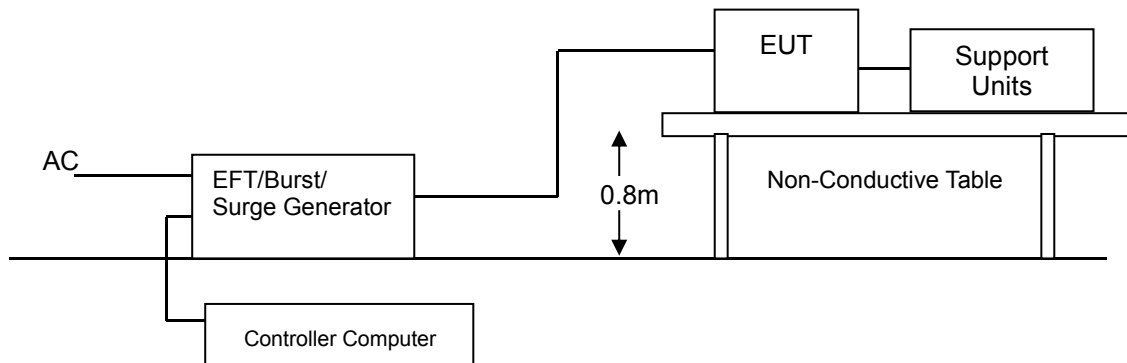

For the actual test configuration, please refer to the related item – Photographs of the Test Configuration.

**NOTE:**

TABLETOP EQUIPMENT

The configuration consisted of a wooden table (0.8m high) standing on the Ground Reference Plane. The GRP consisted of a sheet of aluminum (at least 0.25mm thick and 2.5m square) connected to the protective grounding system. A minimum distance of 0.5m was provided between the EUT and the walls of the laboratory or any other metallic structure.

FLOOR STANDING EQUIPMENT

The EUT installed in a representative system as described in section 7 of IEC 61000-4-4 and its cables, were isolated from the Ground Reference Plane by an insulating support that is 0.1-meter thick. The GRP consisted of a sheet of aluminum (at least 0.25mm thick and 2.5m square) connected to the protective grounding system.

**8.5.5. TEST RESULTS**

<b>Temperature:</b>	25°C	<b>Humidity</b>	55% RH
<b>Pressure</b>	996mbar	<b>Test result</b>	N/A
<b>Test mode</b>	Normal working	<b>Test By</b>	DebeYu

Test Point	Polarity	Test Level (kV)	Performance Criterion	Observation	Result
L 1	+/-	1	B	Note <input type="checkbox"/> 1 <input type="checkbox"/> 2	N/A
L 2	+/-	1	B	Note <input type="checkbox"/> 1 <input type="checkbox"/> 2	N/A
L 1-L 2	+/-	1	B	Note <input type="checkbox"/> 1 <input type="checkbox"/> 2	N/A
PE	+/-	1	B	Note <input type="checkbox"/> 1 <input type="checkbox"/> 2	N/A
L – PE	+/-	1	B	Note <input type="checkbox"/> 1 <input type="checkbox"/> 2	N/A
N – PE	+/-	1	B	Note <input type="checkbox"/> 1 <input type="checkbox"/> 2	N/A
L – N – PE	+/-	1	B	Note <input type="checkbox"/> 1 <input type="checkbox"/> 2	N/A
RJ45 UTP cable	--	--	--	Note <input type="checkbox"/> 1 <input type="checkbox"/> 2	N/A

**NOTE:** 1. There was no change compared with initial operation during the test.  
 2. The loss of function of the EUT during the test and it was recovered by itself operation after the test.

## 8.6. SURGE IMMUNITY TEST

### 8.6.1. TEST SPECIFICATION

<b>Basic Standard:</b>	EN 61000-4-5
<b>Wave-Shape:</b>	Combination Wave 1.2/50 us Open Circuit Voltage 8/20 us Short Circuit Current
<b>Test Voltage:</b>	Power line ~ line to line: 1 kV; line to ground: 2kV Telecommunication line: 1 kV;
<b>Surge Input/Output:</b>	Power Line: L1-L2 / L1-PE / L2-PE Telecommunication line: T-Ground / R-Ground
<b>Generator Source Impedance:</b>	2 ohm between networks 12 ohm between network and ground
<b>Polarity:</b>	Positive/Negative
<b>Phase Angle:</b>	0 /90 /180 /270
<b>Pulse Repetition Rate:</b>	1 time / min. (maximum)
<b>Number of Tests:</b>	5 positive and 5 negative at selected points
<b>Performance Criterion:</b>	B

### 8.6.2. TEST INSTRUMENT

Immunity Shield Room				
Name of Equipment	Manufacturer	Model	Serial Number	Calibration Due
EMC PARTNER TRANSIENT 2000	EMC PARTNER	TRA2000	881	03/13/2020

**NOTE:** 1. The calibration interval of the above test instruments is 12 months and the calibrations are traceable to international system unit (SI).  
2. N.C.R.= No Calibration required

**8.6.3. TEST PROCEDURE**

## a) For EUT power supply:

The surge is applied to the EUT power supply terminals via the capacitive coupling network. Decoupling networks are required in order to avoid possible adverse effects on equipment not under test that may be powered by the same lines, and to provide sufficient decoupling impedance to the surge wave. The power cord between the EUT and the coupling/decoupling networks was shorter than 2 meters in length.

## b) For test applied to unshielded un-symmetrically operated interconnection lines of EUT:

The surge was applied to the lines via the capacitive coupling. The coupling / decoupling networks didn't influence the specified functional conditions of the EUT. The interconnection line between the EUT and the coupling/decoupling networks was shorter than 2 meters in length.

## c) For test applied to unshielded symmetrically operated interconnection / telecommunication lines of EUT:

The surge was applied to the lines via gas arrestors coupling. Test levels below the ignition point of the coupling arrestor were not specified. The interconnection line between the EUT and the coupling/decoupling networks was shorter than 2 meters in length.

### 8.6.4. TEST SETUP

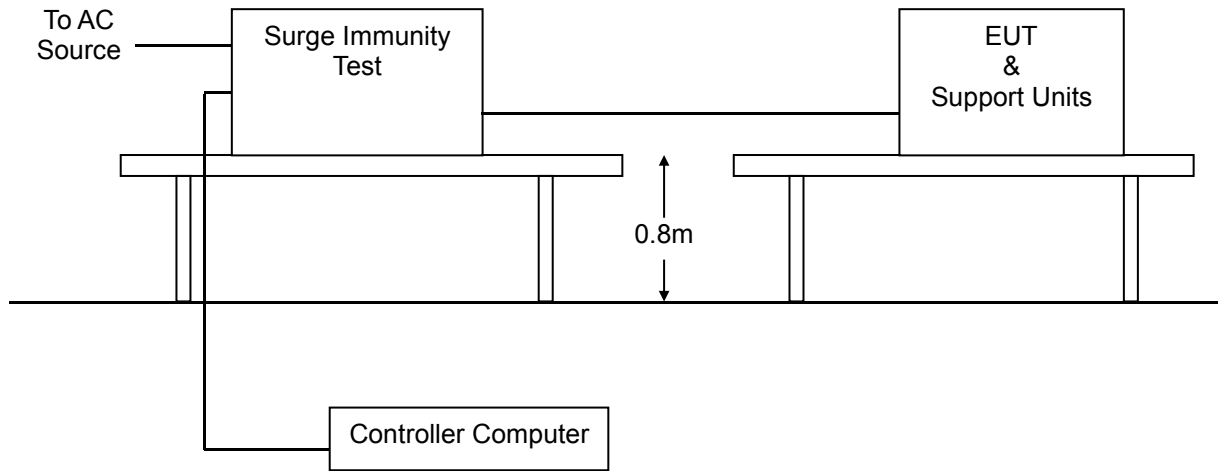

For the actual test configuration, please refer to the related item – Photographs of the Test Configuration.

### 8.6.5. TEST RESULTS

<b>Temperature:</b>	25°C	<b>Humidity</b>	55% RH
<b>Pressure</b>	996mbar	<b>Test result</b>	N/A
<b>Test mode</b>	Normal working	<b>Test By</b>	DebeYu

Test Point	Polarity	Test Level (kV)	Performance Criterion	Observation	Result
L 1 - L 2	+/-	1	B	Note <input type="checkbox"/> 1 <input type="checkbox"/> 2	N/A
L1 - PE	+/-	2	B	Note <input type="checkbox"/> 1 <input type="checkbox"/> 2	N/A
L2 - PE	+/-	2	B	Note <input type="checkbox"/> 1 <input type="checkbox"/> 2	N/A
R - Ground	--	--	--	Note <input type="checkbox"/> 1 <input type="checkbox"/> 2	N/A
T - Ground	--	--	--	Note <input type="checkbox"/> 1 <input type="checkbox"/> 2	N/A

**NOTE:** 1. There was no change compared with initial operation during the test.  
 2. The loss of function of the EUT during the test and it was recovered by itself operation after the test.

## 8.7. CONDUCTED RADIO FREQUENCY DISTURBANCES (CS)

### 8.7.1. TEST SPECIFICATION

<b>Basic Standard:</b>	EN 61000-4-6
<b>Frequency Range:</b>	0.15 MHz ~ 80 MHz
<b>Field Strength:</b>	3 V
<b>Modulation:</b>	1kHz Sine Wave, 80%, AM Modulation
<b>Frequency Step:</b>	1 % of preceding frequency value
<b>Coupled cable:</b>	Power Mains, Shielded
<b>Coupling device:</b>	CDN-M3/2 (3 wires)
<b>Performance criterion:</b>	A

### 8.7.2. TEST INSTRUMENT

CS Test				
Name of Equipment	Manufacturer	Model	Serial Number	Calibration Due
Signal Generator	Maconi	2022D	119246/003	03/19/2020
Power Amplifier	M2S	A00181-1000	9801-112	03/19/2020
CDN	MEB	M3-8016	003683	03/19/2020

**NOTE:** 1. The calibration interval of the above test instruments is 12 months and the calibrations are traceable to international system unit (SI).  
 2. N.C.R.= No Calibration required

### 8.7.3. TEST PROCEDURE

The EUT shall be tested within its intended operating and climatic conditions.

The test shell performed with the test generator connected to each of the coupling and decoupling devices in turn, while the other non-excited RF input ports of the coupling devices are terminated by a 50-ohm load resistor.

The frequency range was swept from 150 kHz to 80 MHz, using the signal level established during the setting process and with a disturbance signal of 80 % amplitude. The signal was modulated with a 1 kHz sine wave, pausing to adjust the RF signal level or the switch coupling devices as necessary. The sweep rate was  $1.5 \times 10^{-3}$  decades/s. Where the frequency range is swept incrementally, the step size was 1 % of preceding frequency value from 150 kHz to 80 MHz.

The dwell time at each frequency was less than the time necessary for the EUT to be exercised, and able to respond. Sensitive frequencies such as clock frequency(ies) and harmonics or frequencies of dominant interest, was analyzed separately.

Attempts were made to fully exercise the EUT during testing, and to fully interrogate all exercise modes selected for susceptibility.



### 8.7.4. TEST SETUP

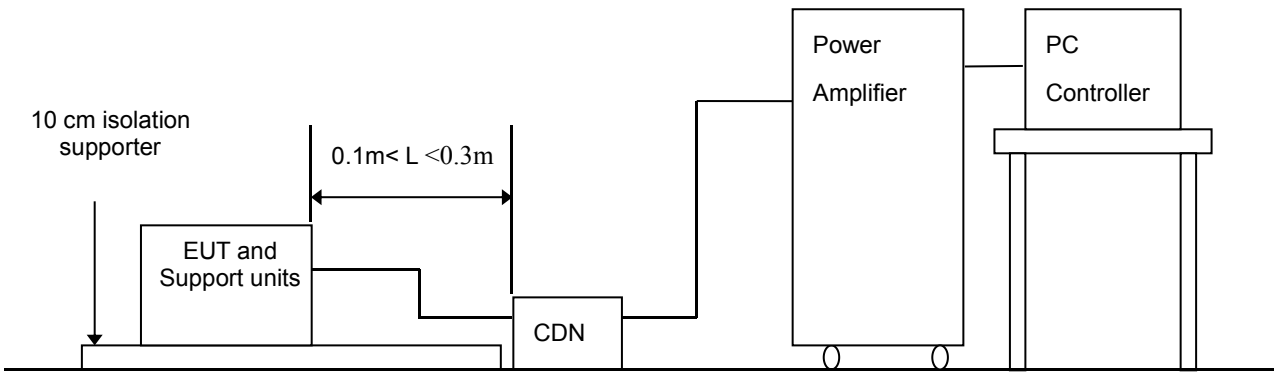

- Note:**
1. The EUT is setup 0.1m above Ground Reference Plane
  2. The CDNS and / or EM clamp used for real test depends on ports and cables configuration of EUT.

For the actual test configuration, please refer to the related item .

**NOTE:**

TABLE-TOP AND FLOOR-STANDING EQUIPMENT

The equipment to be tested is placed on an insulating support of 0.1 meters height above a ground reference plane. All relevant cables shall be provided with the appropriate coupling and decoupling devices at a distance between 0.1 meters and 0.3 meters from the projected geometry of the EUT on the ground reference plane.

### 8.7.5. TEST RESULTS

<b>Temperature:</b>	25°C	<b>Humidity</b>	55% RH
<b>Pressure</b>	996mbar	<b>Test result</b>	N/A
<b>Test mode</b>	Normal working	<b>Test By</b>	DebeYu

Frequency Band (MHz)	Field Strength (Vrms)	Injected Position	Injection Method	Performance Criterion	Observation	Result
0.15 ~ 80	3	AC Mains	CDN-M3	A	Note <input type="checkbox"/> 1 <input type="checkbox"/> 2	N/A
0.15 ~ 80	3	LAN(10m)	--	--	Note <input type="checkbox"/> 1 <input type="checkbox"/> 2	N/A

- NOTE:** 1. There was no change compared with initial operation during the test.  
 2. The loss of function of the EUT during the test and it was recovered by itself operation after the test.  
 3.N/A means to no applicable.

## 8.8. POWER FREQUENCY MAGNETIC FIELD

### 8.8.1. TEST SPECIFICATION

<b>Basic Standard:</b>	EN 61000-4-8
<b>Frequency Range:</b>	50Hz
<b>Field Strength:</b>	1A/m
<b>Observation Time:</b>	5 minutes
<b>Inductance Coil:</b>	Rectangular type, 1mx1m
<b>Performance criterion:</b>	A

### 8.8.2. TEST INSTRUMENT

Immunity Shield Room				
Name of Equipment	Manufacturer	Model	Serial Number	Calibration Due
Power-frequency Magnetic field	SCHAFFNER	CCN 1000-1	72046	03/17/2020
Induction Coil Interface	SCHAFFNER	INA2141	6003	03/17/2020

**NOTE:** 1. The calibration interval of the above test instruments is 12 months and the calibrations are traceable to international system unit (SI).

2. N.C.R.= No Calibration required

### 8.8.3. TEST PROCEDURE

- a. The equipment is configured and connected to satisfy its functional requirements. It shall be placed on the GRP with the interposition of a 0.1m-thick insulating support.
- b. The equipment cabinets shall be connected to the safety earth directly on the GRP via the earth terminal of the EUT.
- c. The power supply, input and output circuits shall be connected to the sources of power supply, control and signal.
- d. The cables supplied or recommended by the equipment manufacturer shall be used. 1 meter of all cables used shall be exposed to the magnetic field.

### 8.8.4. TEST SETUP

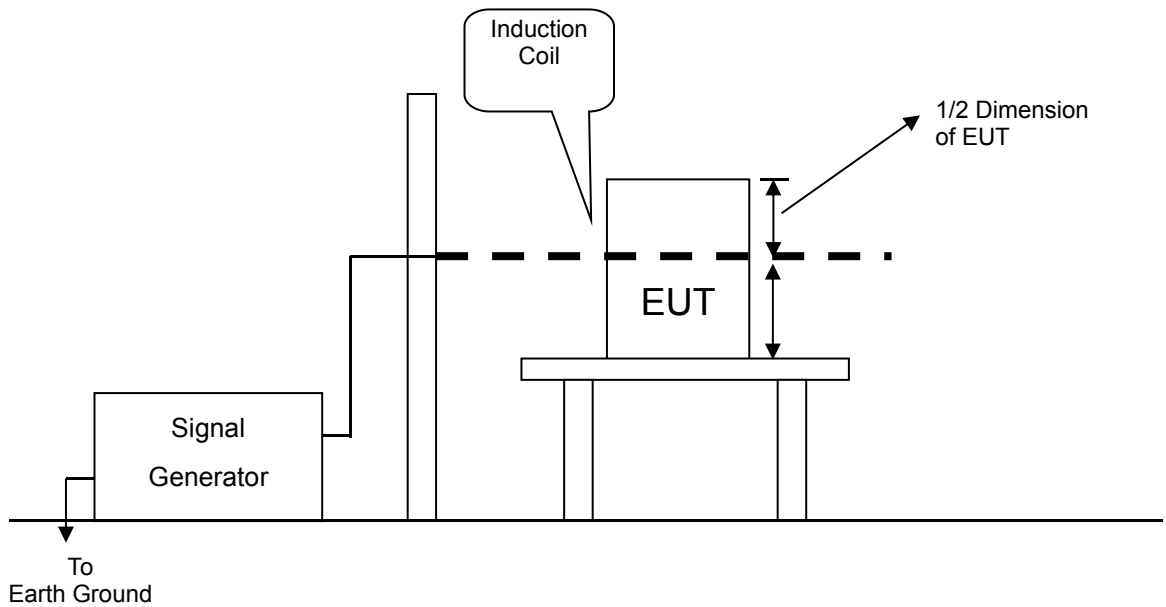

For the actual test configuration, please refer to the related item .

#### NOTE:

##### TABLETOP EQUIPMENT

The equipment shall be subjected to the test magnetic field by using the induction coil of standard dimension (1 m x 1 m). The induction coil shall then be rotated by 90 degrees in order to expose the EUT to the test field with different orientations.

##### FLOOR-STANDING EQUIPMENT

The equipment shall be subjected to the test magnetic field by using induction coils of suitable dimensions. The test shall be repeated by moving and shifting the induction coils, in order to test the whole volume of the EUT for each orthogonal direction. The test shall be repeated with the coil shifted to different positions along the side of the EUT, in steps corresponding to 50 % of the shortest side of the coil. The induction coil shall then be rotated by 90 degrees in order to expose the EUT to the test field with different orientations.

### 8.8.5. TEST RESULTS

<b>Temperature:</b>	25°C	<b>Humidity</b>	55% RH
<b>Pressure</b>	996mbar	<b>Test result</b>	N/A
<b>Test mode</b>	Normal working	<b>Test By</b>	DebeYu

DIRECTION	Field Strength (A/m)	Performance Criterion	OBSERVATION	RESULTS
X	1	A	Note <input checked="" type="checkbox"/> 1 <input type="checkbox"/> 2	N/A
Y	1	A	Note <input checked="" type="checkbox"/> 1 <input type="checkbox"/> 2	N/A
Z	1	A	Note <input checked="" type="checkbox"/> 1 <input type="checkbox"/> 2	N/A

**NOTE:** 1. There was no change compared with initial operation during the test.  
 2. The loss of function of the EUT during the test and it was recovered by itself operation after the test.

## 8.9. VOLTAGE DIP & VOLTAGE INTERRUPTIONS

### 8.9.1. TEST SPECIFICATION

<b>Basic Standard:</b>	EN 61000-4-11
<b>Test duration time:</b>	Minimum three test events in sequence
<b>Interval between event:</b>	Minimum 10 seconds
<b>Phase Angle:</b>	0 /45 / 90/ 135/ 180/ 225/ 270/ 315/ 360
<b>Test cycle:</b>	3 times
<b>Performance criterion:</b>	B,C

### 8.9.2. TEST INSTRUMENT

Immunity shielded room				
Name of Equipment	Manufacturer	Model	Serial Number	Calibration Due
EMC PARTNER TRANSIENT 2000	EMC PARTNER	TRA2000	881	03/13/2020

**NOTE:** 1. The calibration interval of the above test instruments is 12 months and the calibrations are traceable to international system unit (SI).  
2. N.C.R.= No Calibration required

### 8.9.3. TEST PROCEDURE

1. The EUT and support units were located on a wooden table, 0.8 m away from ground floor.
2. Setting the parameter of tests and then perform the test software of test simulator.
3. Conditions changes to occur at 0 degree crossover point of the voltage waveform.
4. Recording the test result in test record form.

### 8.9.4. TEST SETUP

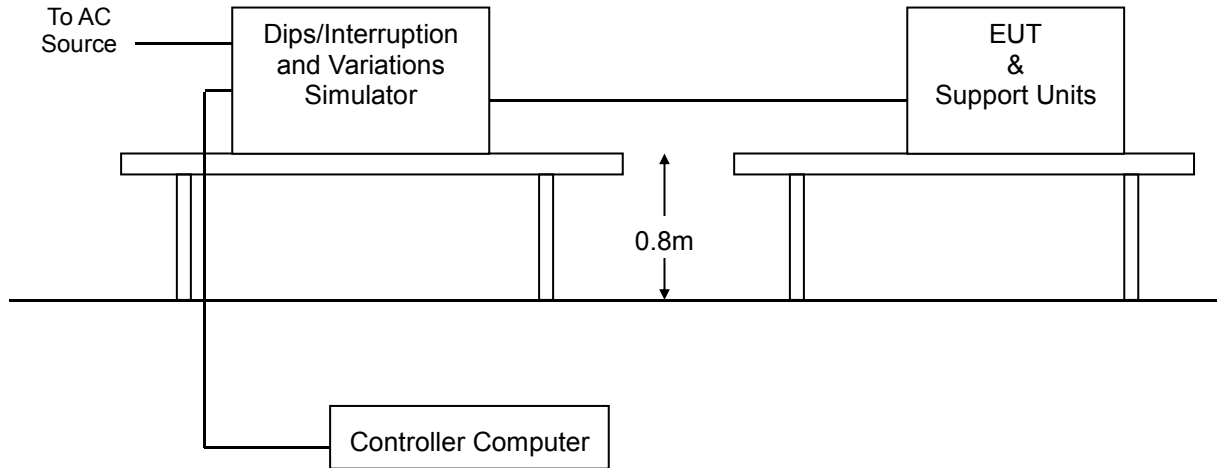

For the actual test configuration, please refer to the related item – Photographs of the Test Configuration.

### 8.9.5. TEST RESULTS

<b>Temperature:</b>	25°C	<b>Humidity</b>	55% RH
<b>Pressure</b>	996mbar	<b>Test result</b>	N/A
<b>Test mode</b>	Normal working	<b>Test By</b>	DebeYu

Voltage (% Reduction)	Duration (Period)	Performance Criterion	Observation	Test Result
98	0.5	<input type="checkbox"/> A <input type="checkbox"/> B <input type="checkbox"/> C	Note <input type="checkbox"/> 1 <input type="checkbox"/> 2 <input type="checkbox"/> 3	N/A
30	25	<input type="checkbox"/> A <input type="checkbox"/> B <input type="checkbox"/> C	Note <input type="checkbox"/> 1 <input type="checkbox"/> 2 <input type="checkbox"/> 3	N/A
100	250	<input type="checkbox"/> A <input type="checkbox"/> B <input type="checkbox"/> C	Note <input type="checkbox"/> 1 <input type="checkbox"/> 2 <input type="checkbox"/> 3	N/A

- NOTE:** 1. There was no change compared with initial operation during and after the test.  
 No unintentional response was found during the test.  
 2. The function stopped during the test, but can be recoverable by itself operation after the test.  
 3. The function stopped during the test, but can be recoverable manually after the test.

## 9 PHOTOGRAPHS OF THE TEST CONFIGURATION

### RADIATED EMISSION TEST





## 10 PHOTOGRAPHS OF EUT

Appearance photograph of EUT



Appearance photograph of EUT



Appearance photograph of EUT

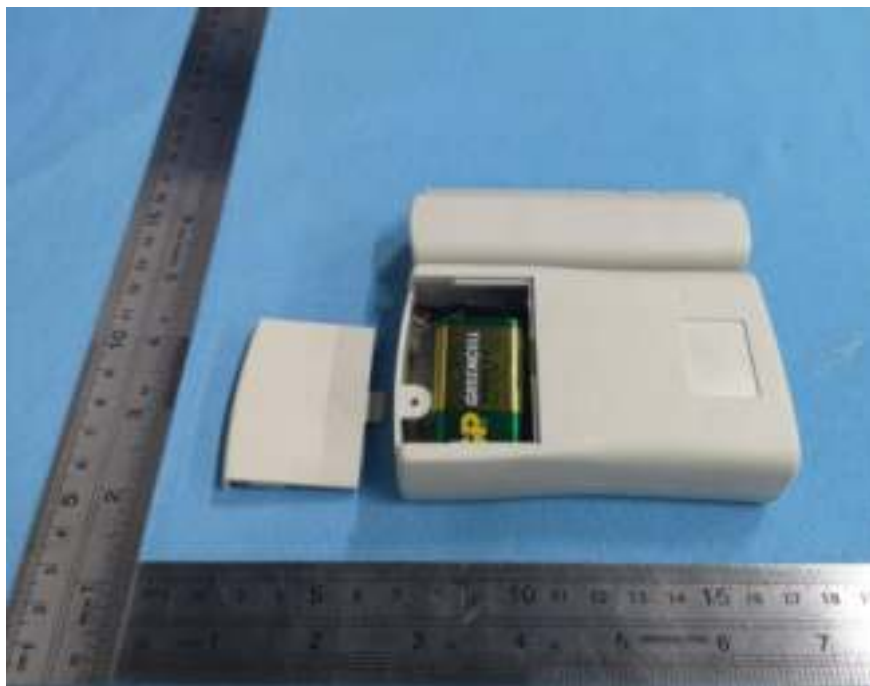

Appearance photograph of EUT

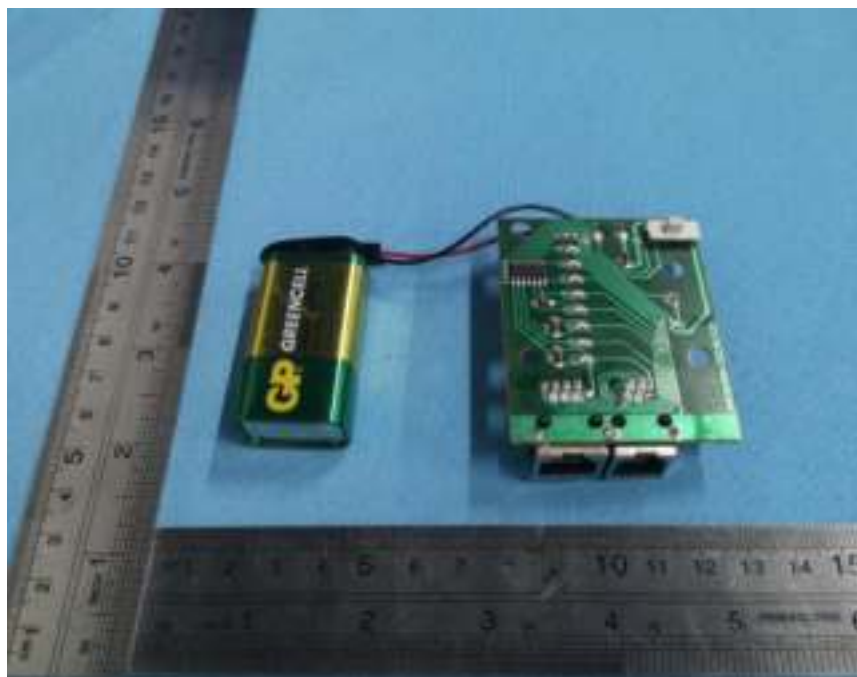

Appearance photograph of EUT

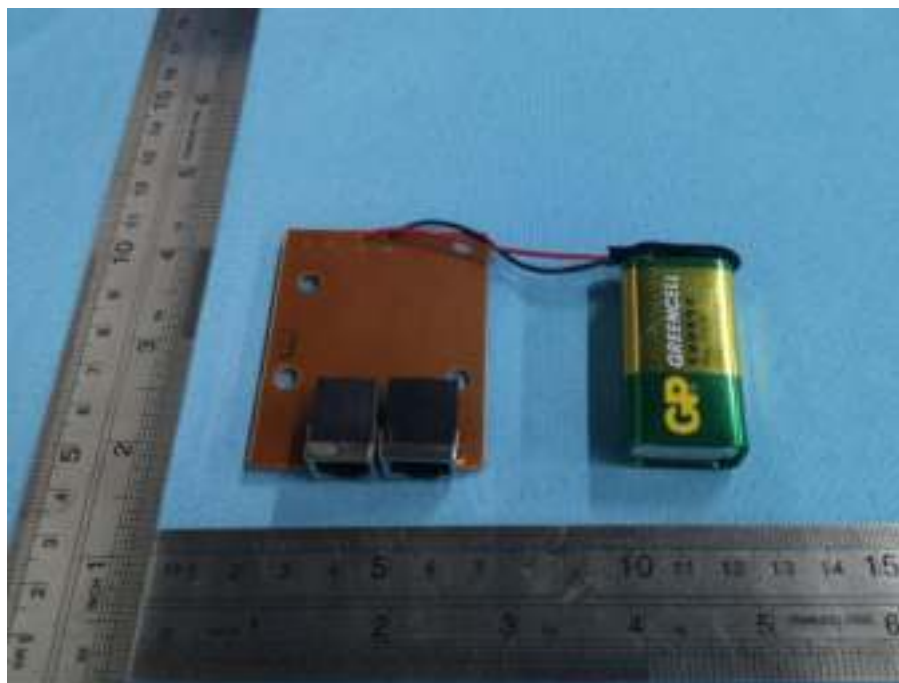

Appearance photograph of EUT

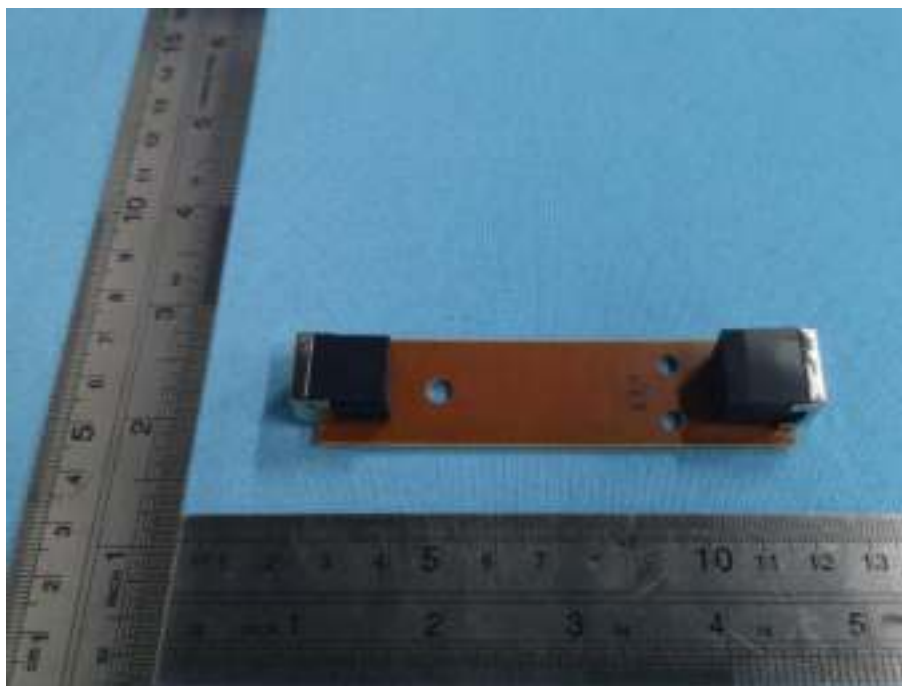

\*\*\*\*\*END OF REPORT\*\*\*\*\*