

Metal Garden Shed

Metalen tuinhuisje

OWNER'S MANUAL / Gebruikshandleiding

Instructions for Assembly Instructies voor montage

Size 8' x 6' Maat: 9,3 m3

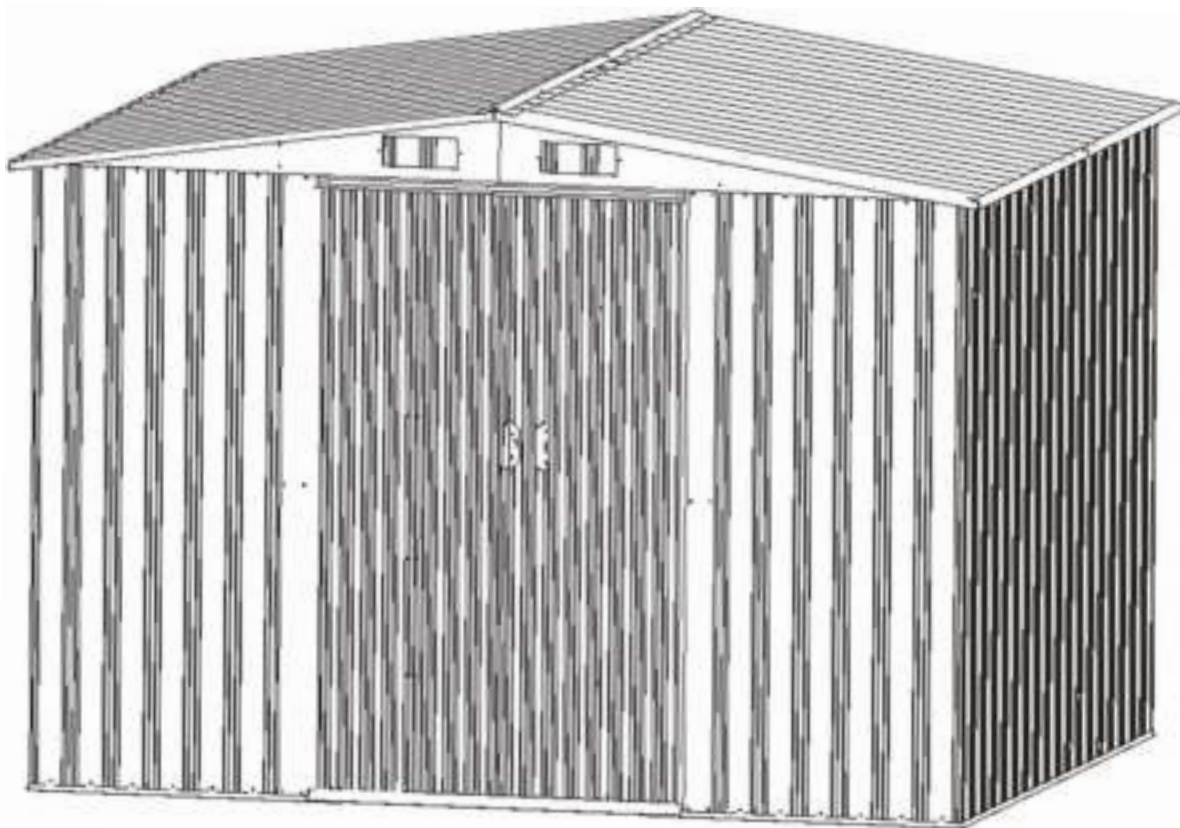

WAARSCHUWING

Lees de instructies a.u.b. zorgvuldig door voordat u begint met het opzetten van dit product.
Volg de instructies a.u.b. zorgvuldig op wanneer u dit product opzet. Controleer voor de zekerheid of alle benodigde onderdelen in de verpakkingen zitten.
Om letsel te voorkomen, wordt tijdens de montage het dragen van werkhandschoenen aanbevolen.

WARNING

Please read the instruction manual carefully before assembly
Please assembly strictly in accordance with the instruction
Please double-check to ensure that all parts of the package contents intact To avoid injury work gloves are recommended during assembly

It will take 2-3 hours for 2 people to install.

Het monteren neemt 2-3 uur in beslag voor 2 mensen.

Voordat u begint

Gebruikshandleiding:

Voordat u begint met het bouwen van dit tuinhuisje, kan het verstandig zijn om lokale regels omtrent funderingen, locatie en andere afspraken te raadplegen. Neem deze handleiding zorgvuldig door, zodat u er zeker van bent dat u het proces begrijpt. Deze belangrijke informatie en tips zullen u helpen tijdens de constructie, waardoor dit makkelijker en met meer plezier gaat

Montage instructies:

Alle instructies bevinden zich in deze handleiding en dienen voldoende te zijn om dit model te bouwen. Bekijk alle instructies voor u begint en terwijl u bezig bent. Indien de stappen zorgvuldig gevolgd worden, krijgt u een correct resultaat.

Onderdelen en de onderdelenlijst:

Controleer voor u begint of u alle onderdelen heeft ontvangen.

Leg alle onderdelen van hetzelfde nummer bij elkaar.

De pagina naast de onderdelen lijst laat globaal zien waar elk onderdeel hoort.

Neem de tijd om u zelf bekend te maken met alle onderdelen die in het pakket zitten.

N.B.: er zijn een aantal extra onderdelen toegevoegd voor uw gemak.

Plan vooruit

Raadpleeg het weerbericht:

Zorg er voor dat u een dag kiest met rustig en droog weer. Probeer niet te gaan bouwen op een dag met veel en/of harde wind.

Teamwork:

Indien mogelijk, werk met twee of meer personen om dit model te bouwen. Een persoon kan de onderdelen en panel positioneren en een ander kan de onderdelen bevestigen.

Zorg en onderhoud

Afwerking:

Voor een nette afwerking en om te zorgen dat het model langer in goede staat blijft, raden wij u aan om regelmatig het model schoon te maken en de buitenkant te polijsten.

Dak: Reinig het dak van bladeren en sneeuw met een zachte bezem. Een grote hoeveelheid sneeuw kan het dak beschadigen en het onveilig maken om het tuinhuis te betreden.

Deuren: Zorg ervoor dat de deurrails vrij blijven van vuil, zodat de deuren makkelijk kunnen blijven schuiven. U kunt de rails jaarlijks met silicone spray inspuiten om het soepel te houden. Zorg ervoor dat u de deuren goed sluit en op slot doet om schade door de wind te voorkomen.

Bevestigingsmateriaal: Gebruik het bevestigingsmateriaal wat geleverd is om het tuinhuis goed te kunnen beschermen tegen weerschade. Controleer regelmatig of alles nog stevig vast zit en verstevig waar nodig.

















Vocht: Een kunststof plaat of zeil onder het vloergedeelte kan zorgen voor verminderde condensatie en eventuele vochtschade.

















Andere tips: Was eventuele inktvlekken op de platen af met zeep en water.















Gebruik eventueel een siliconen kit om de randen dicht te kitten om het tuinhuis waterdicht te maken.

Bewaar geen zwembad chemicaliën of licht-ontvlambaar en bijtende middelen in dit tuinhuis.

PARTS LIST

PART	NO.	Qty.
	1	2
	2	2
	3L	1
	3R	1
	4L	1
	4R	1
	5	1
	6	1
	7	1
	8	1
	9	2
	11	2
	10L	1
	10R	1
	13	4
	14	4
	15	2

PART	NO.	Qty.
	16	2
	17	2
	18	2
	19	2
	20	4
	21L	2
	21R	2
	25L	1
	25R	1
	27	2
	P1	2
	P2	4
	P3	12
	P4	2
	P5	4
	P6	4

PART	NO.	Qty.
	P7	2
	D1	1
	D2	1
	B1	8
	G2	4
	GB	2
	GC	4
	GD	4
	GE	2
	GF	4
	F1	320
	F2	95
	F3	8
	S1	170
	S2	429

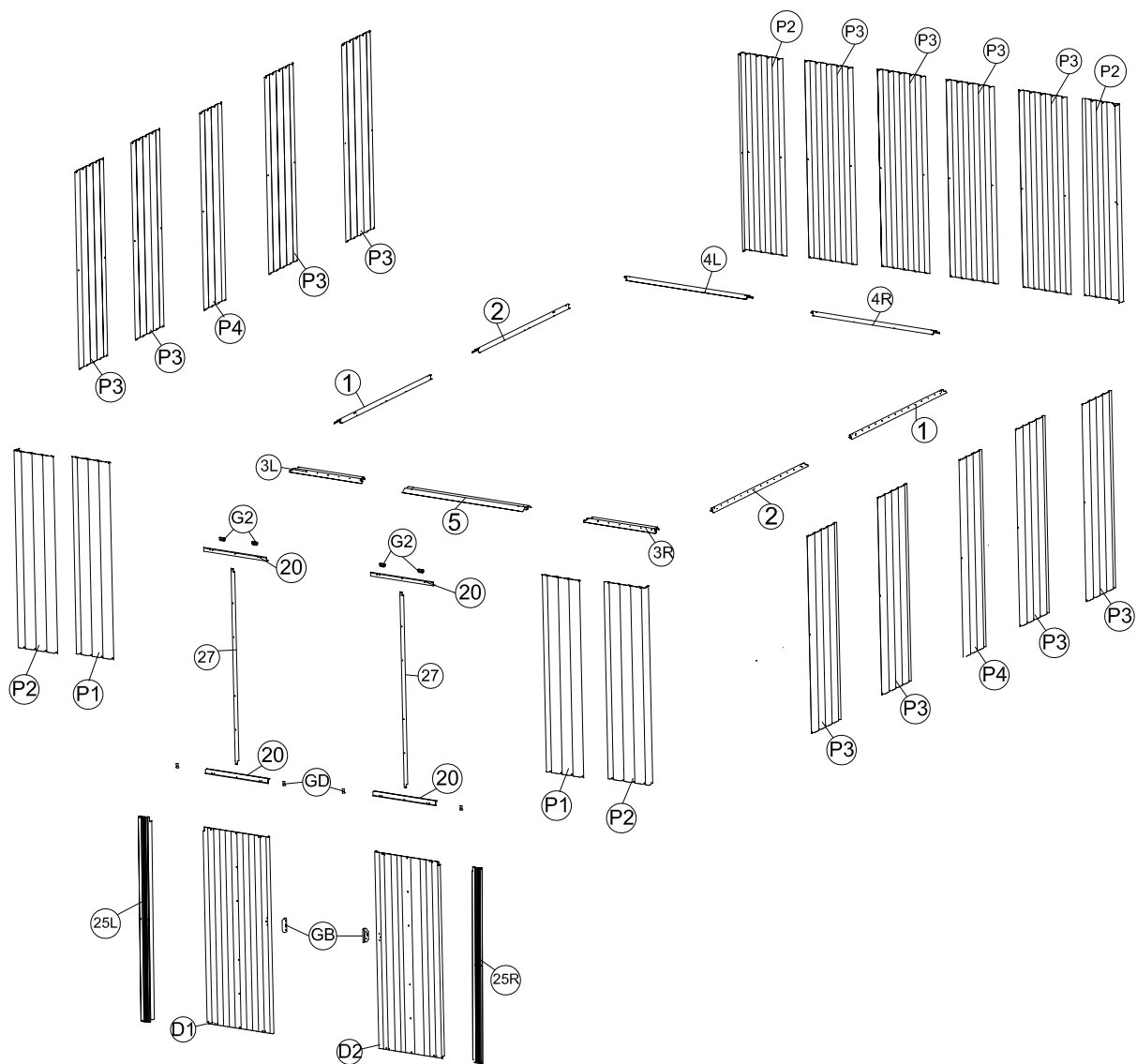
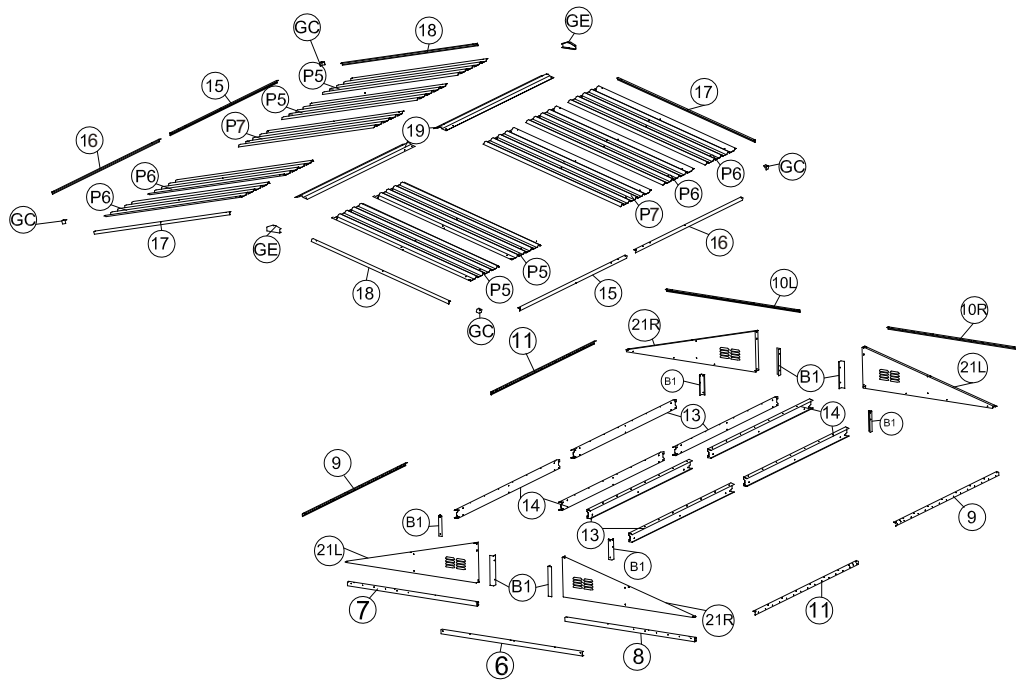







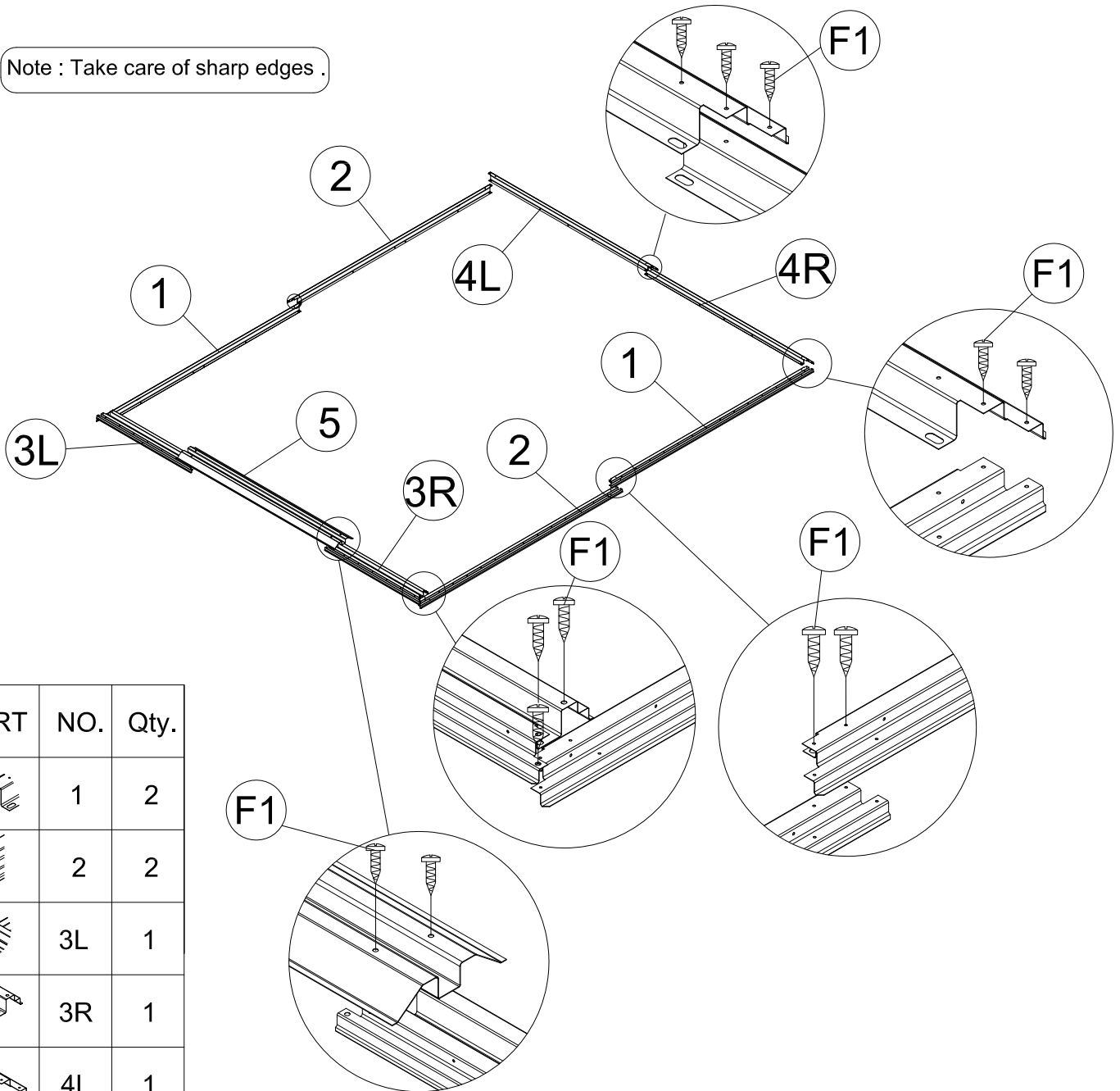

1

(NL) Monteer de fundering van (1) tot (4R) met (F1) schroeven. Plaats vervolgens de drempel van de ingang (5) bovenop balk (3L) en (3R). Bevestig met de schroeven (F1) aan de fundering. Zorg ervoor dat de fundering in een perfect vierkant is gemonteerd.

(ENG) Assemble base bars from (1) to (4R) with (F1) screws. Then place the entrance taper channel (5) on top of the bar (3L) and (3R). Secure with (F1) screws to the foundation. Make sure to assembly the base in a perfect square.

Note : Take care of sharp edges .



PART	NO.	Qty.
	1	2
	2	2
	3L	1
	3R	1
	4L	1
	4R	1
	5	1
	F1	24

2

(NL) Plaats de muurpanelen (P1, P2, P3, P4) op de grondbalk uit stap 1, zoals hieronder afgebeeld.





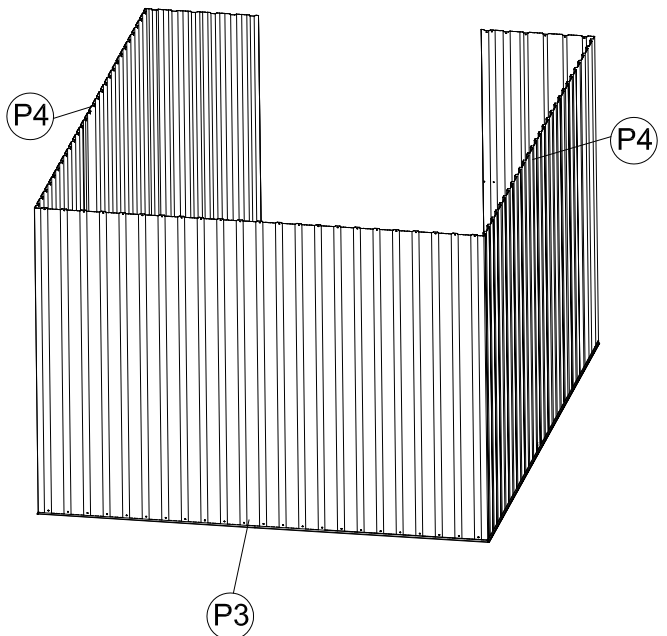
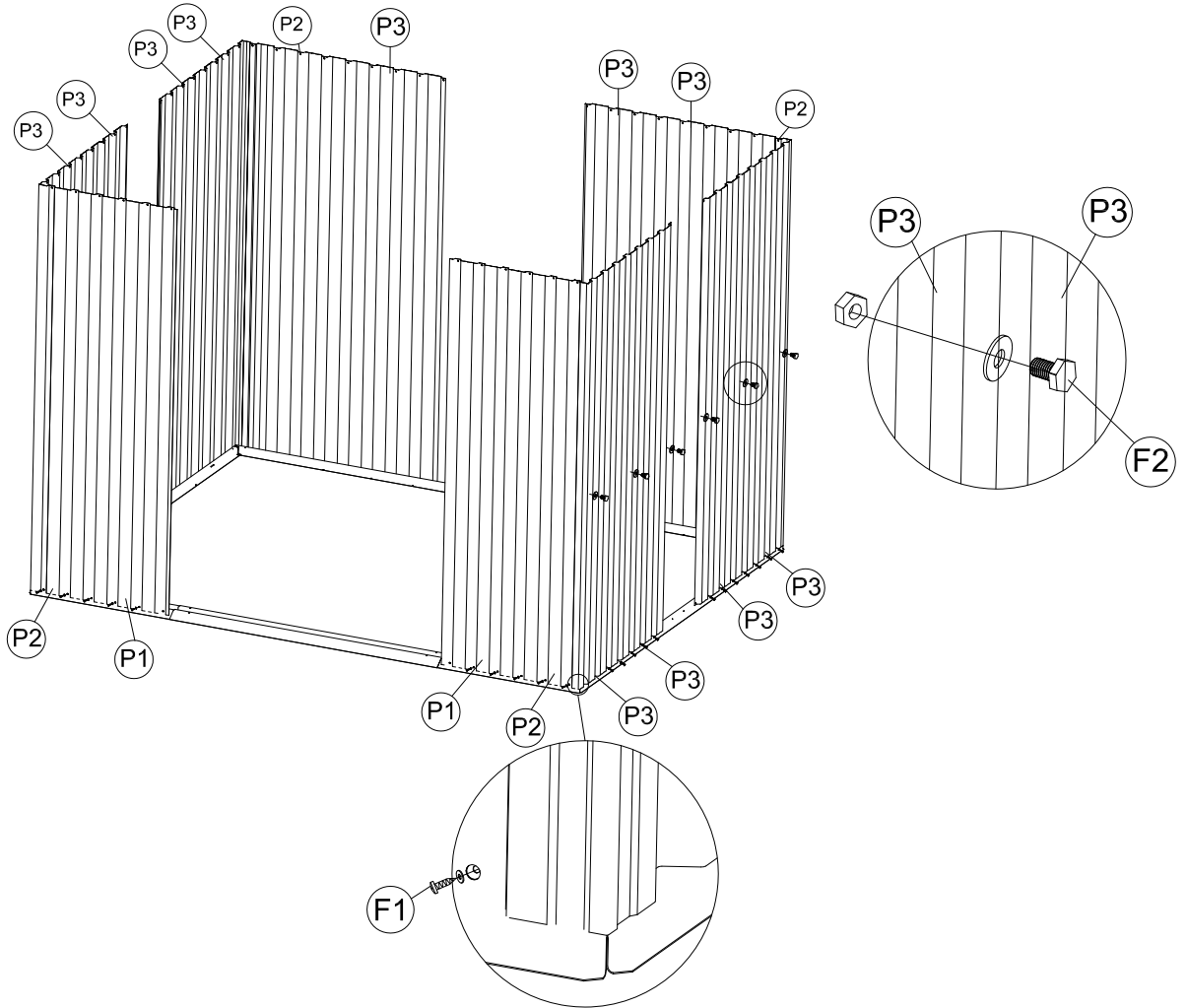

De gaten in de zijpanelen dienen overeen te komen met de gaten in de grondbalken. Bevestig deze met de F1 schroeven.

Gebruik de ringetjes aan de buitenkant van het tuinhuisje om de gaten goed af te sluiten voor bijvoorbeeld regen.

(ENG) Place the wall panel (P1), (P2), (P3) and (P4), on the base bar (1), (3L), (3R), (4L) and (4R) as showing.

Side wall of the shed line up the holes with base bar. Secure with (F1). Screws with washer from outside.



PART	NO.	Qty.
	P1	2
	P2	4
	P3	12
	P4	2
	F1	73
	F2	19

3

(NL) 3 Plaats eerst beide stukken van (G2). Schuif vanaf de zijkant in het de rails (8). Zie uitvergroting.
 Monteer de deurstang (6) tussen de voorwandpanelen (P1) en plaats vervolgens de rails (7) en (8) in de deurstang (6). Zorg ervoor dat u onderdeel G2 kunt zien, hierop worden de deuren later gemonteerd.
 Breng de gaten op één lijn met het wandpaneel. Gebruik (F1) schroeven met sluitringen om te bevestigen. Zie de positie in onderstaande figuren.

Opmerking: Rails (7) en (8) hebben geen gaten, maar u kunt hier doorheen schroeven of boren.

(ENG) Insert the 2 pieces of (G2). Top slider into the sliding channel (8). See the blow-up. Assemble the door bar (6) between the front wall panel (P1), and then place the sliding channel (7) and (8) on top of front wall panels from inside. Line up the holes with the wall panels. Use (F1) screws with washers to fix. See the position in the figure below.

Note: Rails (7) and (8) has no holes, but you can screw or drill through them.

Note: Make sure the position of the projection on (G2) towards inside.

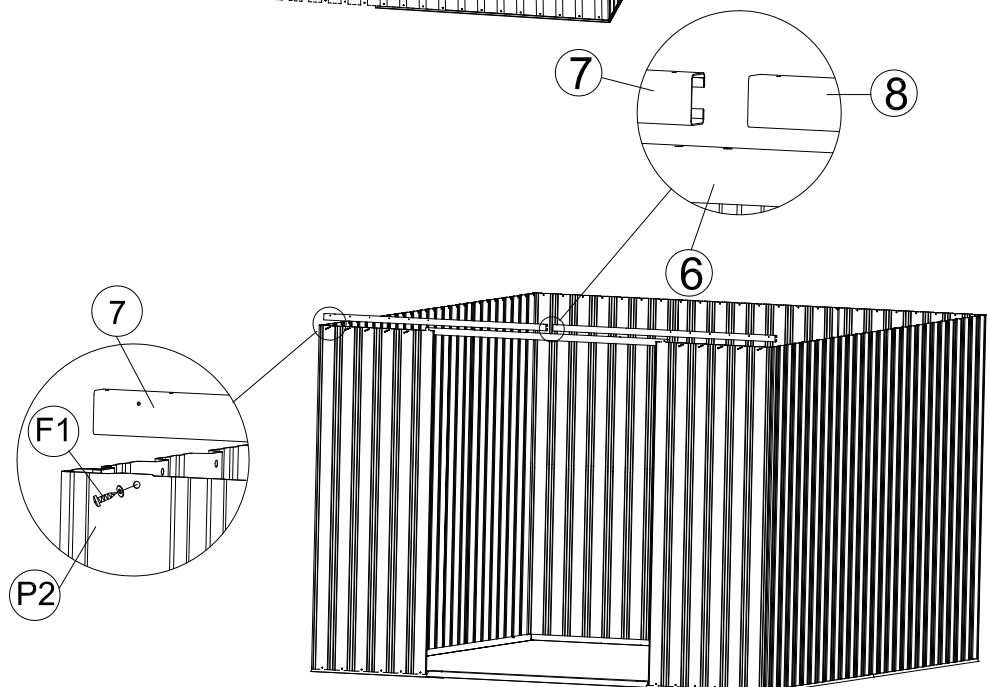
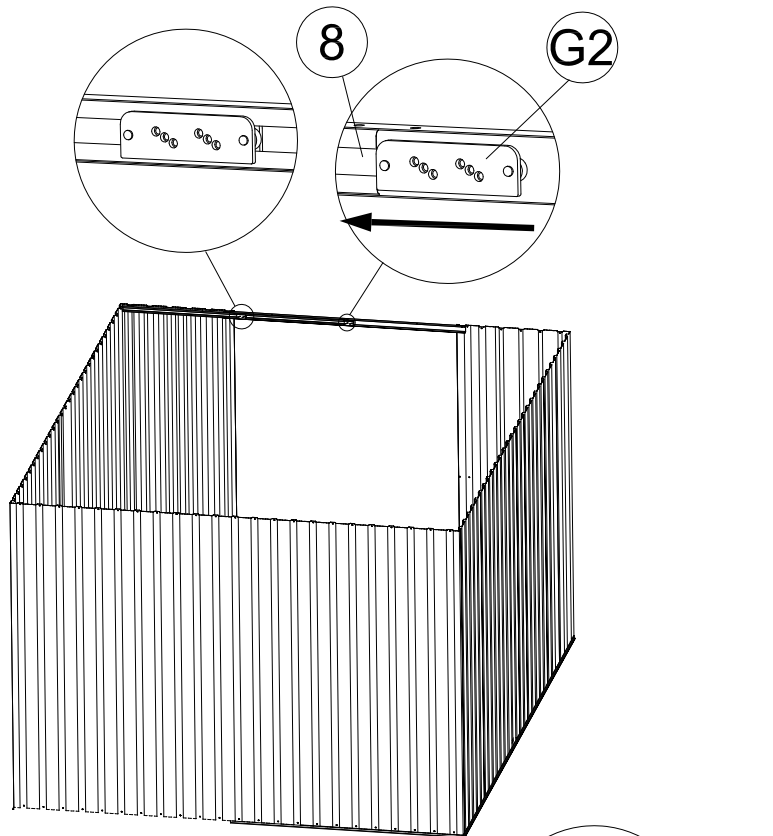
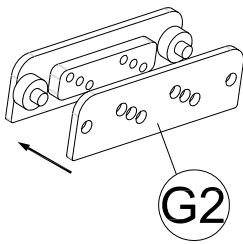

PART	NO.	Qty.
	6	1
	7	1
	8	1
	G2	4
	F1	14

4

(NL)Plaats de bovenste L-vormige balken (9), (10L), (10R) en (11) op de bovenkant van de wandpanelen.
Lijn de gaten uit met de wandpanelen en bevestig met de (F1) schroeven.

Opmerking: Let op, de balken zullen overlappen, zie de uitvergroting.

(ENG) Place the top angle bars (9),(10L),(10R) and (11) on the top of wall panel.Line up the holes with wall panels and fix with (F1) screws.

Note: The bars will overlap, see the blow-up.

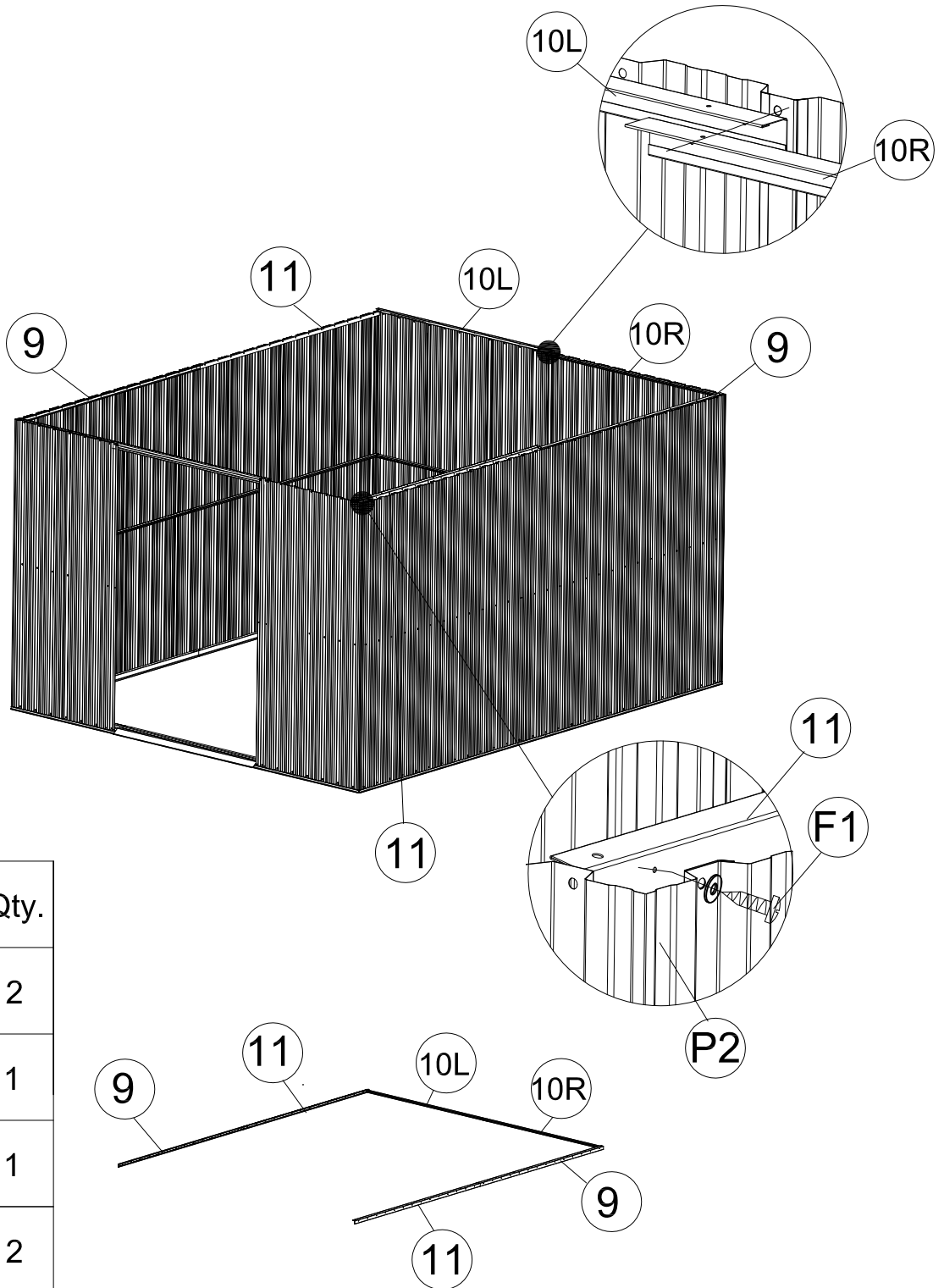





PART	NO.	Qty.
	9	2
	10L	1
	10R	1
	11	2
	F1	71

5

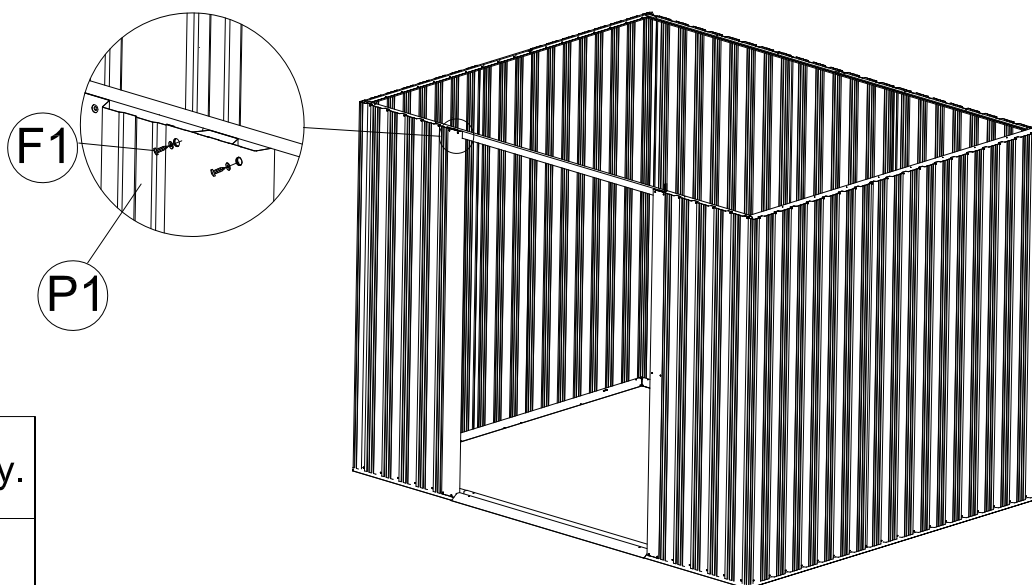
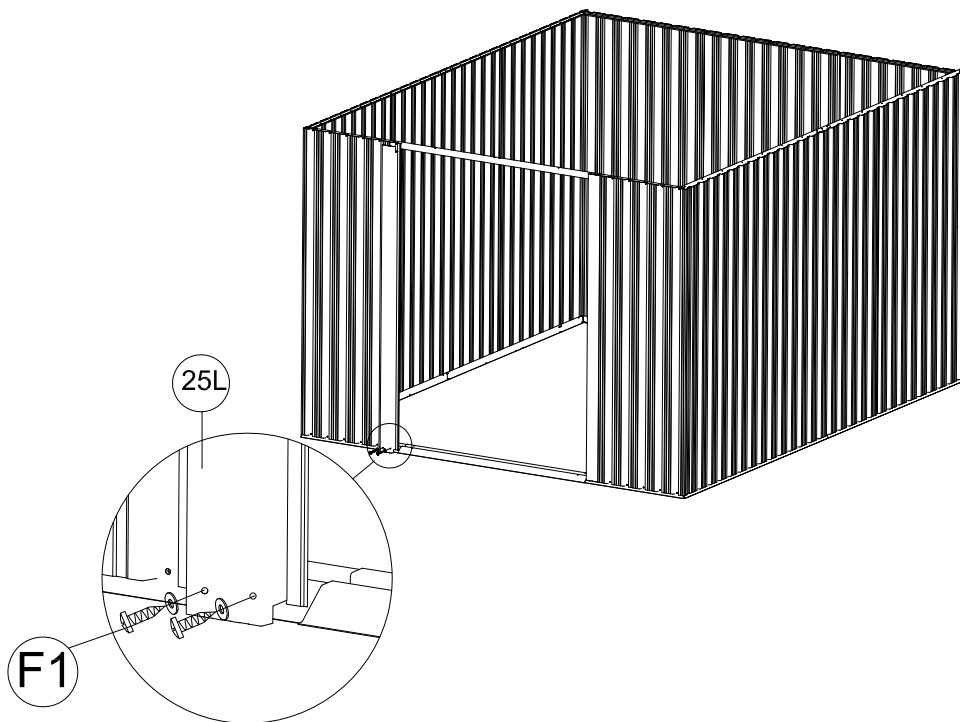
(NL) 5 Plaats de linker deurpilaar (25L) op de bovenkant van de grondbalk (3L) en plaats op het wandpaneel. Bevestig vervolgens de deurkolom (25L) met (F1) schroeven.
Herhaal dezelfde actie voor de rechter deurpilaar (25R).

(ENG) Place the left door column (25L) on the top of base bar (3L), Insert into the wall panel. Then secure the door column (25L) with (F1) screws. Repeat the same for the right door column (25R).



PART	NO.	Qty.
	25L	1
	25R	1
	F1	12

6

(NL) Plaats 4 delen van de gevelpanelen (21L) en (21R).

Monteer vervolgens 2 gevelplaten (21L) en (21R) samen met de connector (B1) zoals getoond. Zet ze vast met (F2) bout en moer. Zie onderstaande figuren.

Verbind de twee dakdragers (13) en (14) met elkaar en bevestig vervolgens 4 sets dakconstructies in de gevelpanelen (21L) en (21R). Lijn de gaten uit en zet ze vast met (F2) bout en moer.

(ENG) Place 4 piece of the Gable panels (21L) and (21R). Then assembly 2 each Gable panels (21L) and (21R) together with connector (B1), and assemble the connectors (B1) as showed. secure them with (F2) bolt and nut. see figures below. Join two roof supports (13) and (14) together then fix 4 sets of roof structures into the Gable panels (21L) and (21R). Align the holes and secure with (F2) bolt and nut.

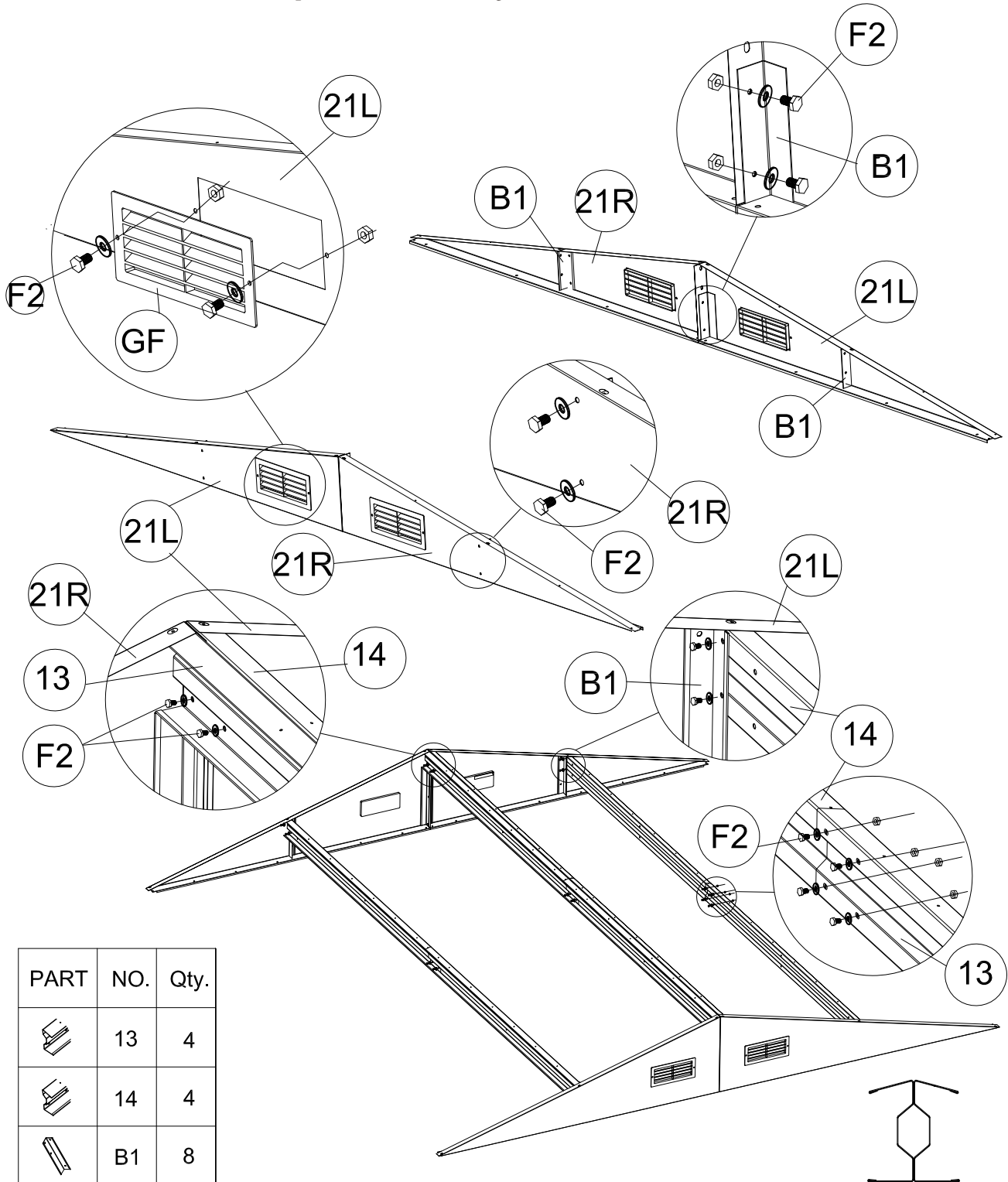



PART	NO.	Qty.			
	13	4			
	14	4			
	B1	8			
	21L	2		GF	4
	21R	2		F2	40

7

(NL) Plaats de constructie uit stap 6 (de gevelpanelen (21L) en (21R) (13) (14)) op de bovenkant van de rails (7) (8) en achterbalken (10L). (10R), lijn de gaten uit en zet ze vast met (F1) schroeven van binnenuit zoals getoond

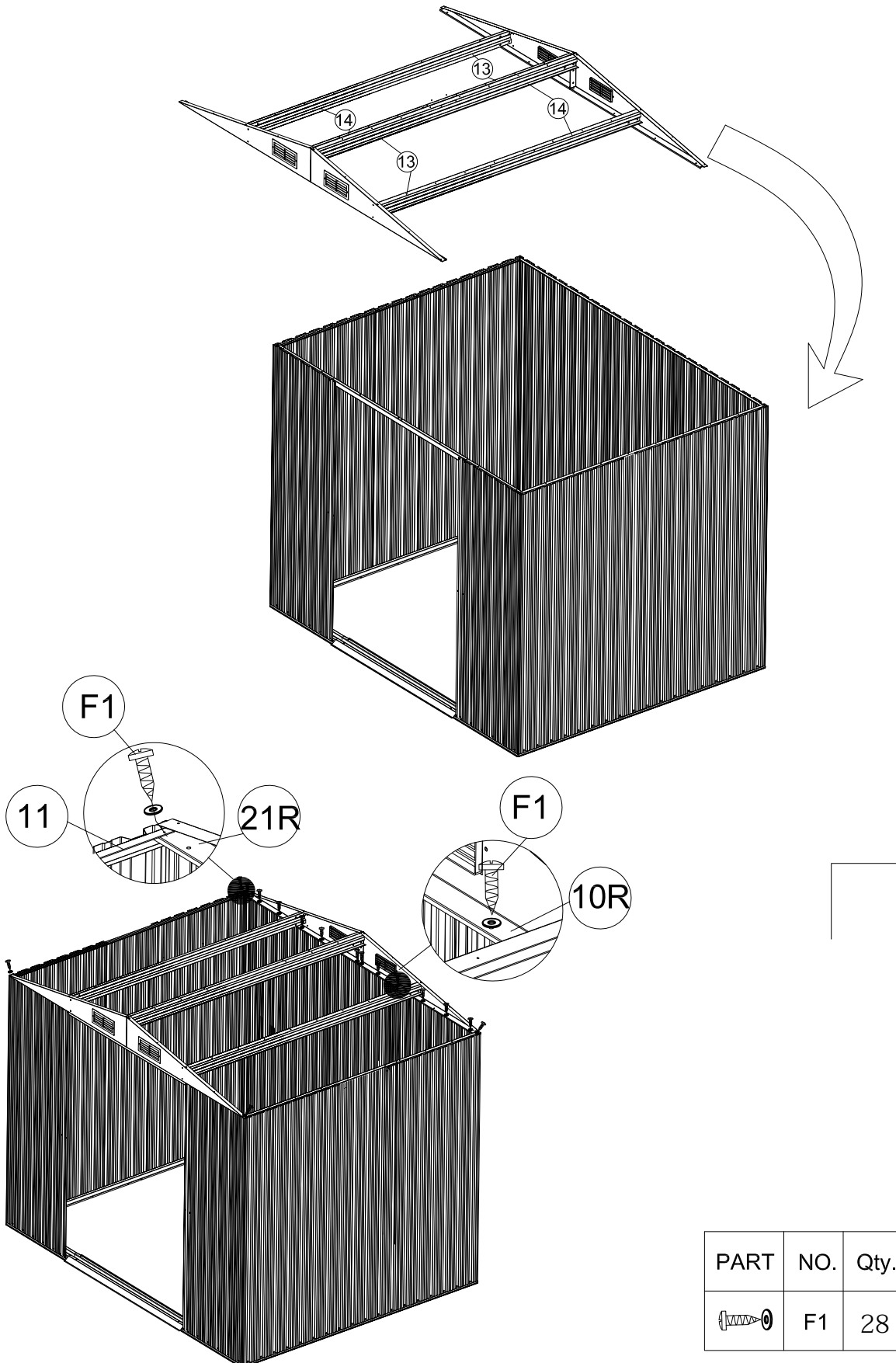
(ENG) Place 4 pieces of the gable panels (21L) and (21R) (13) (14) on the top of the sliding channels (7), (8) and back top bars (10L), (10R). Align the holes and secure them with (F1) screws from inside as showed.



PART	NO.	Qty.
	F1	28





8

(NL) Plaats de dakpanelen (P5), (P6) en (P7) op de bovenkant van de gevelconstructie (21L). Lijn de gaten uit en zet ze vast met (F1) bout, moer en sluitringen. Plaats vervolgens de andere dakpanelen en zet ze vast met (F1) schroeven met sluitringen. Opmerking: Zorg ervoor dat de dakpanelen overlappen zoals op de afbeelding.

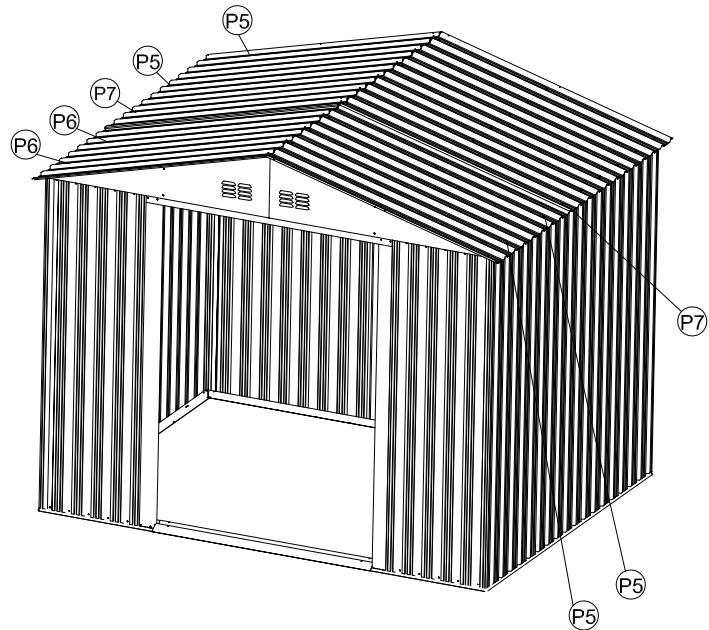
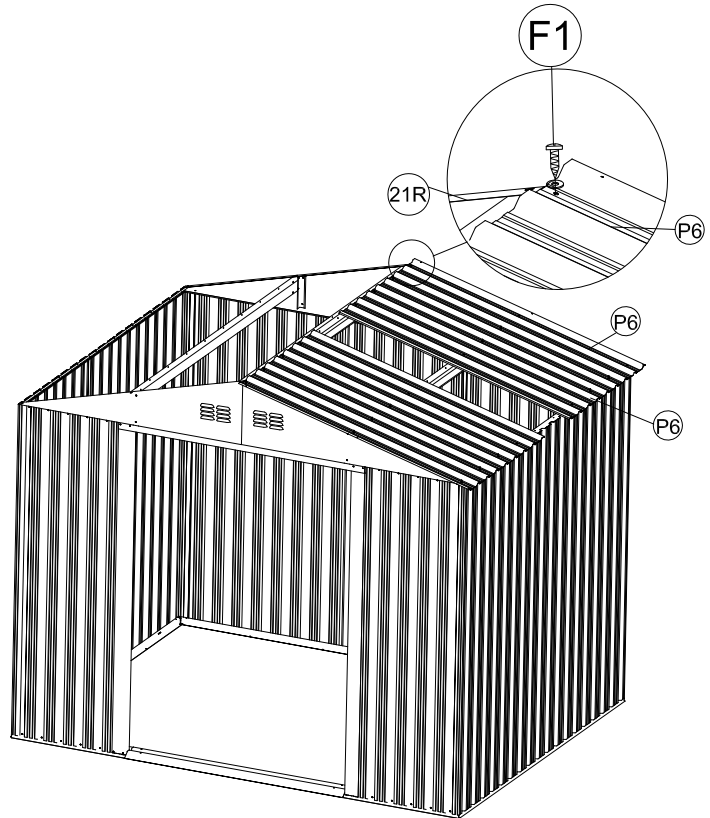
(ENG) Place the roof panels (P5),(P6)and (P7) on the top of Gable panel (21L) , Line up the holes and secure with (F1) bolt , and nut with washers .Then place the roof panels secure them with (F1) screws with washers.

Note:
Make sure the overlapping position for roof panel is as shown in blowup







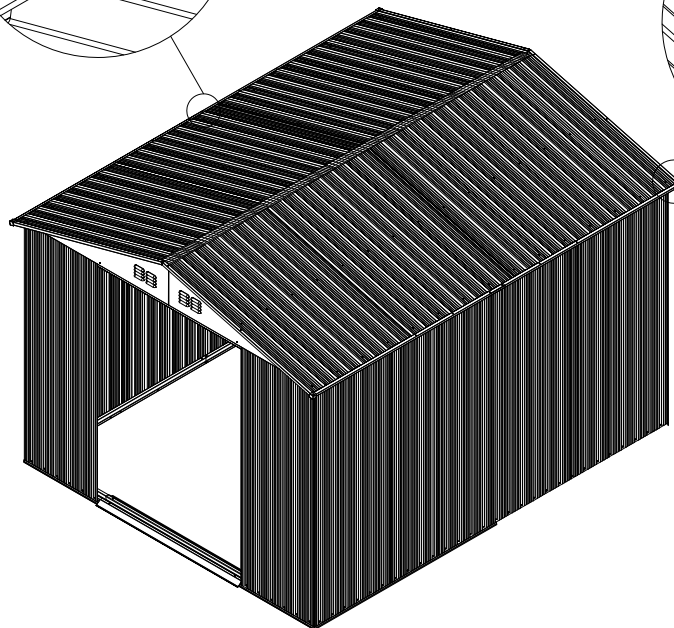
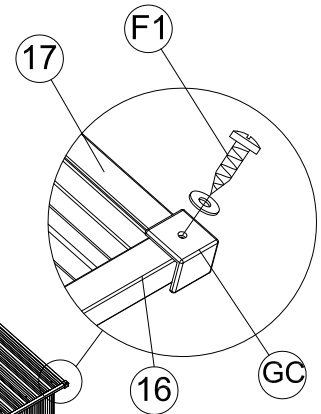
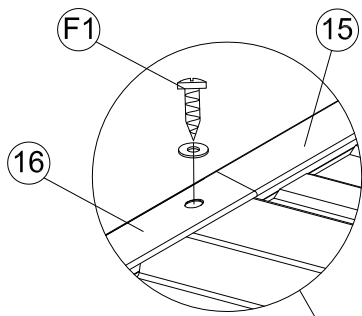
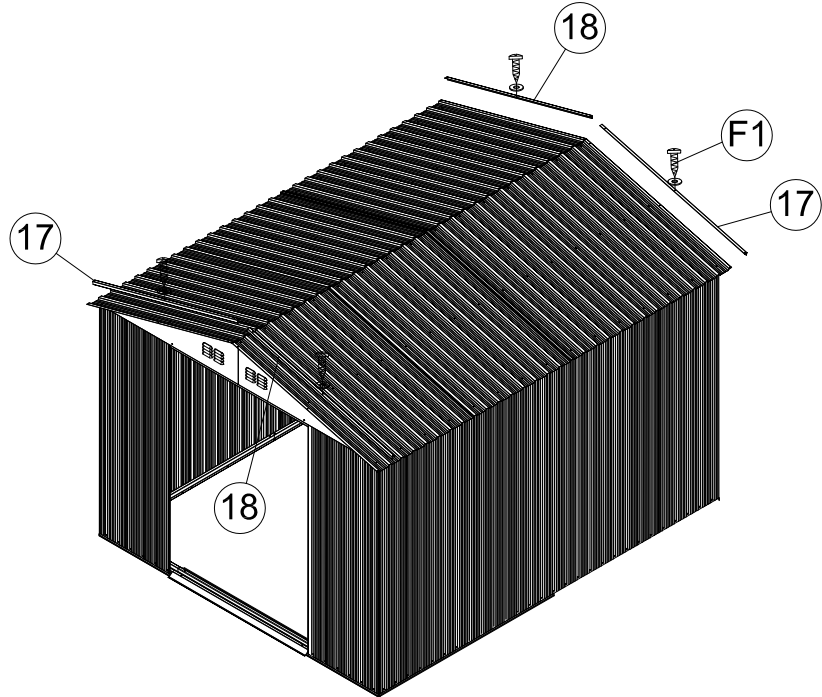

PART	NO.	Qty.
	P5	4
	P6	4
	P7	2
	F1	66

9

(NL) Monteer de hoekranden (15) (16) en (17), (18) met dakpanelen, zet vast met (f1) schroeven met sluitringen.
 Plaats vervolgens 4 stukken hoekstukken (GC) op de hoek van de hoekverbindingen en zet vast met (F1) schroeven met sluitringen. Zie afbeeldingen hieronder.

(ENG) Assemble the roof flashing (15)(16), and (17),(18) with roof panels, secure with {F1} screws with washers. Then place 4 piece of top corner {GC} on the roof flashing joints, and secure with {F1} screws with washers.



PART	NO.	Qty.
	17	2
	18	2
	15	2
	16	2
	GC	4
	F1	10



10

(NL) Plaats de twee nokpanelen (19) op de dakpanelen, lijn de gaten uit en zet ze vast met (F1) schroeven met sluitringen. Schuif vervolgens de nok-beschermkap (GE) op de voor- en achterkant van het nokpaneel en zet vast met (F1) schroeven met sluitringen.

Zie onderstaande figuren.

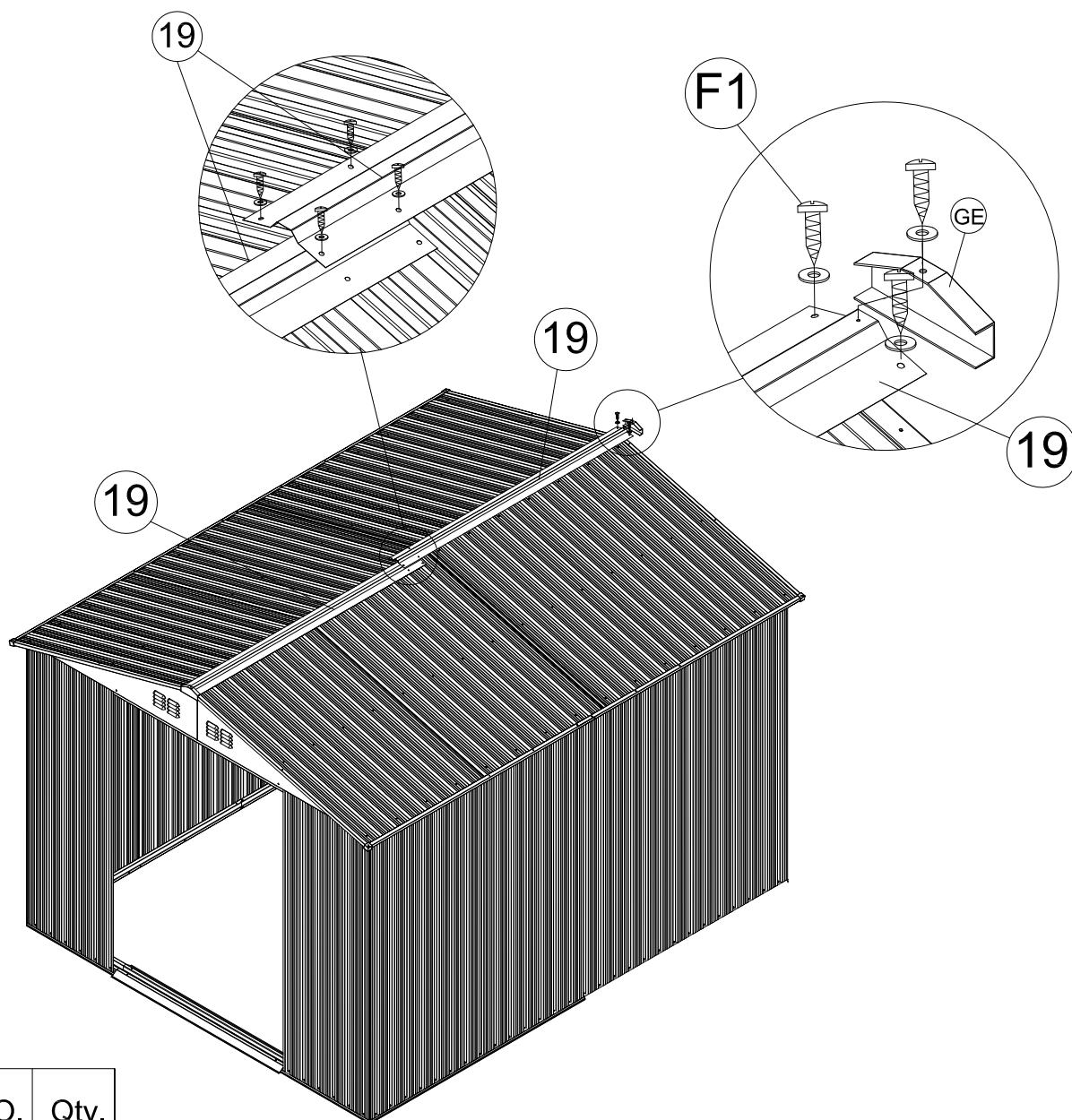
(ENG) Place two pieces of the roof flashing center (19) on top of the roof panels, Line up the holes and secure them with (F1) screws with washers. Then slide the flashing end cap (GE) to the front & back top of the roof and secure with (F1) screws with washers. See figures below.



PART	NO.	Qty.
	19	2
	GE	2
	F1	10





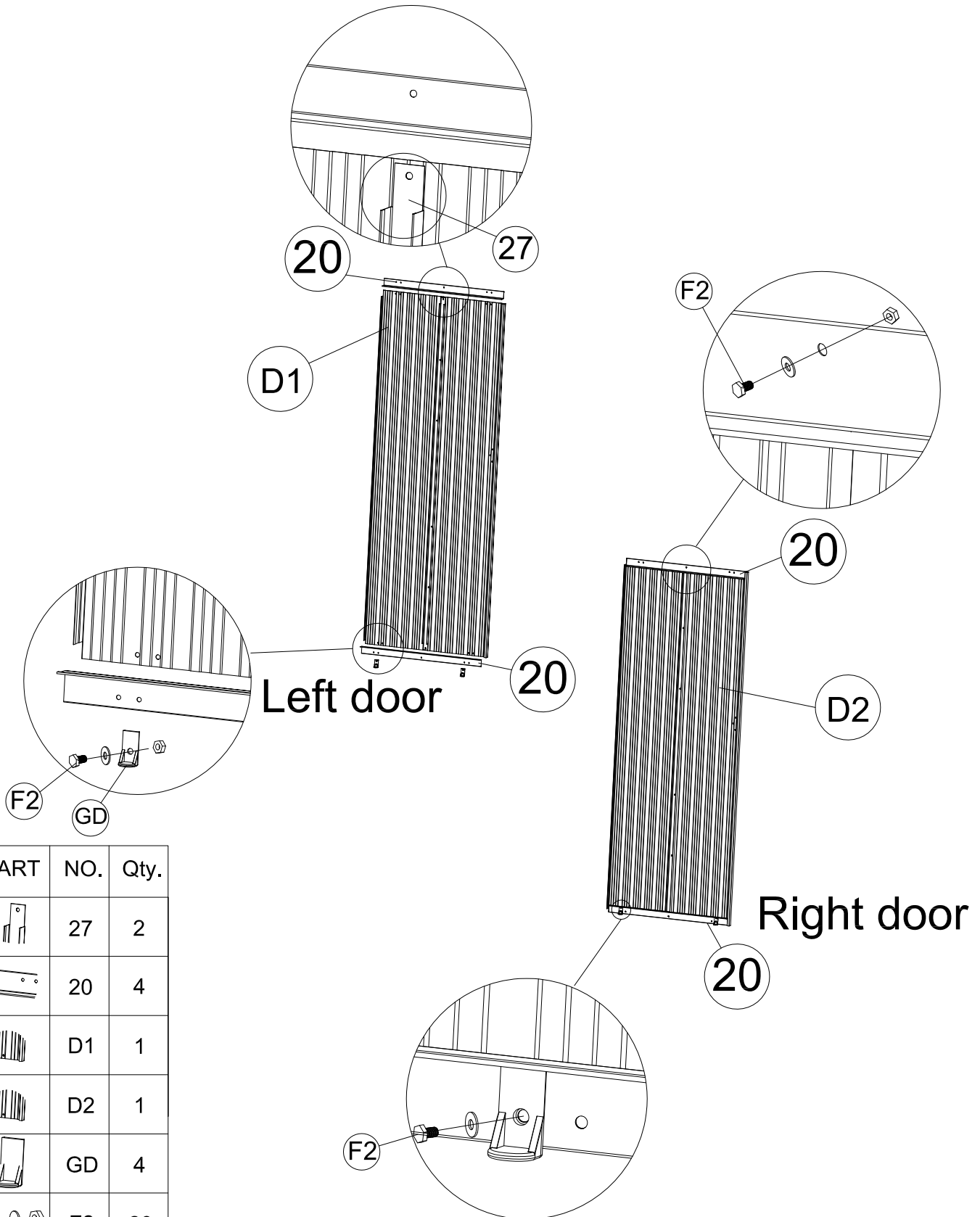

11

(NL) Monteer de deurstang (20) op de deurpanelen (D1) en (d2) en bevestig stang (27).

Monteer vervolgens onderdeel (GD) onder aan de deurstang (20) aan beide onderranden. Zet ze vast met (f2) bout en moer en met sluitring.

(ENG) Assemble the door bar (20) to the door panels (D1) and (D2) and fix them to the withbar (27). Then assemble the bottom slider (GD) to the door bar (20) at both bottom edges. Scure them with (F2) bolt and nut with washer.





PART	NO.	Qty.
	27	2
	20	4
	D1	1
	D2	1
	GD	4
	F2	20

12

(NL) Bevestig de delen van de deurklink (D2) aan de deurpanelen van binnenuit met (F2) bout en moer.

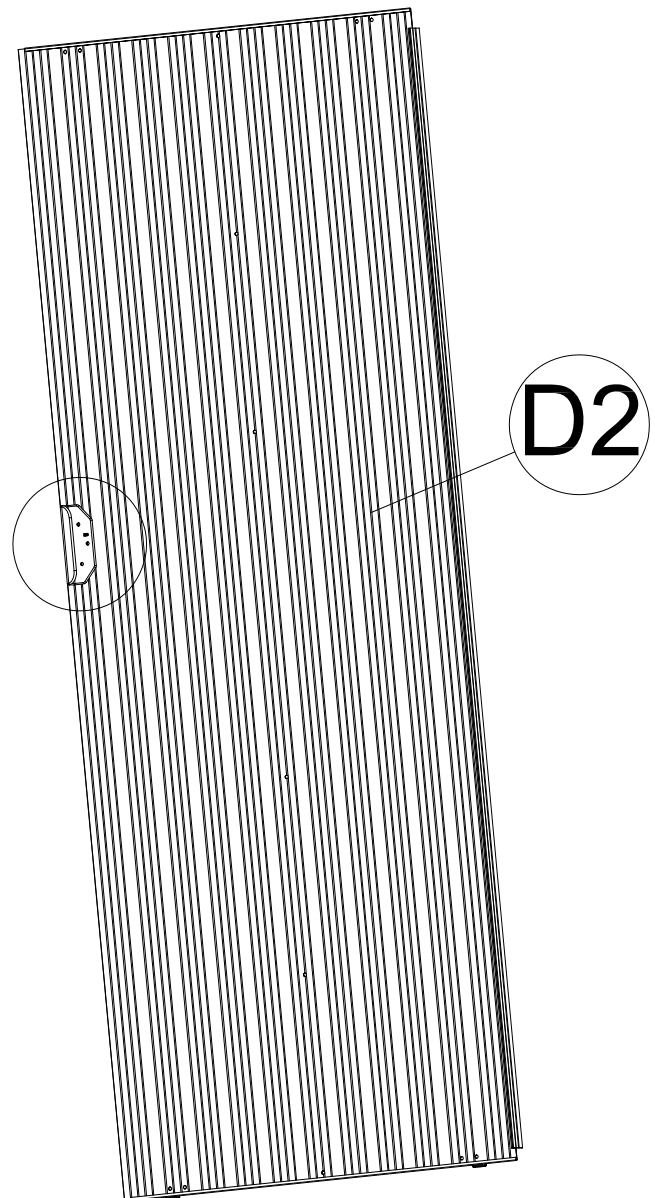
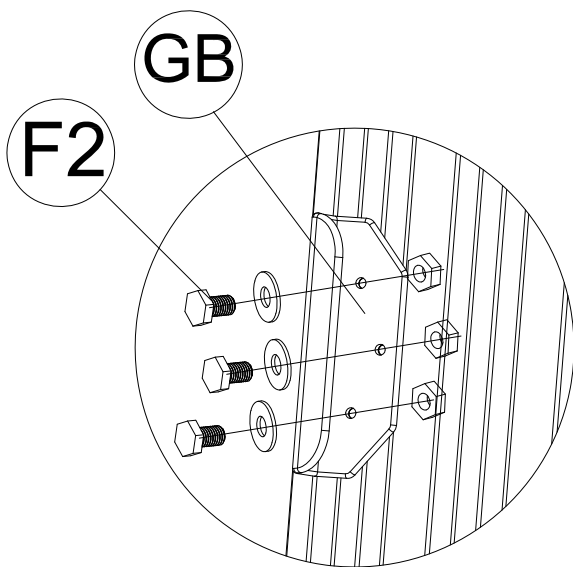
(ENG) Fix 2 pieces of the door handle (D2) with the door handle (D2) with door panels from inside with (F2) bolt and nut.

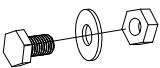

PART	NO.	Qty.
	GB	2
	F2	6

13

(NL) Schuif het deurpaneel in de grondbalk (3L).

Zorg ervoor dat het onderdeel (GD) in de basisbalk (3L) schuift en bevestig vervolgens de bovenkant van het deurpaneel aan de schuif (G2) in de rails met (F3) schroeven.

Zie onderstaande figuren. Herhaal deze stap voor de andere deur in (3R).

Opmerking: Zorg ervoor dat de deur goed is uitgelijnd en lijn de gaten uit met het deurpaneel.

(ENG) Slide the door panel assembly into the base bar (3L). Make sure the bottom slider (GD) should slide inside the base bar (3L), then fix the door panel top to the top slider (G2) with (F3) screws. See figures below.

Note: Make sure to get proper alignment of the door realign the holes with door panel

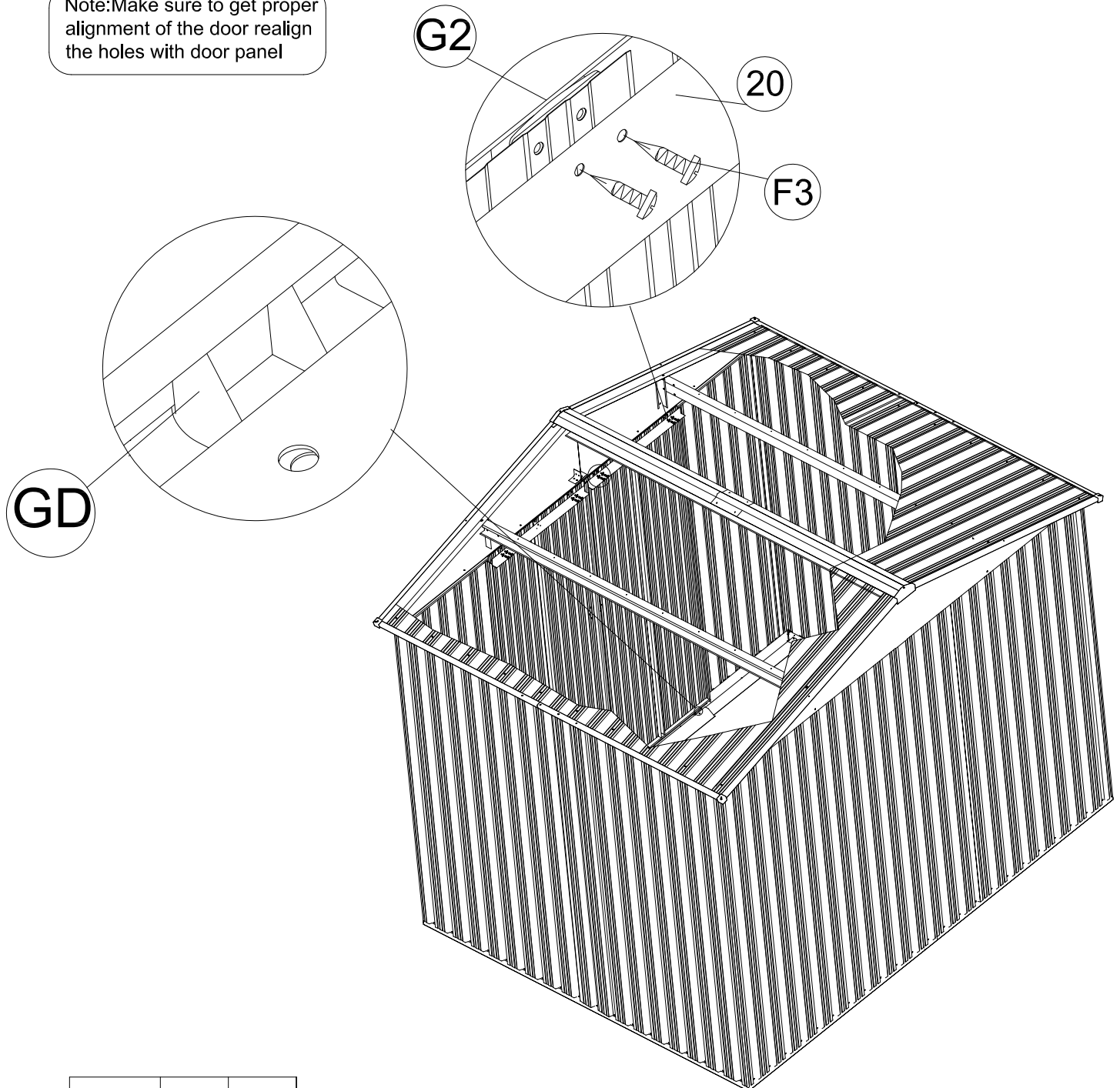

PART	NO.	Qty.
	F3	8