



USER MANUAL
ACW10





How to install and operate the DLS ACTIVE SUBWOOFER ACW10

Welcome!

This owners manual is written in easy english and uses a lot of drawings to simply the installation and use of the above amplifiers.

Your DLS amplifiers must be installed correctly in order to perform at its best. This manual will show you how to install the amplifier like a pro. Please read the entire manual before beginning the installation. Install the amplifier yourself if you feel confident with our instructions and if you have the proper tools. However if you feel unsure, turn over the installation job to someone better suited to it.

Warranty Service

This amplifier is covered by warranty, depending on the conditions in the country where it is sold. If the Subwoofer is returned for service, please include the original dated receipt with the product.

Technical Assistance

For technical assistance ask the shop where the product was sold or the distributor in your very country. Information can also be found on our WEB-site www.dls.se

We follow a policy of continuous advancement in development. For this reason all or part of specifications & designs may be changed without prior notice.

Contents

Features.....	2-5
Installation.....	6-9
Troubleshooting / Testing.....	10-11
Specifications.....	12



This product must be returned to the separate collection system for electronic products. Do not dispose this product together with general household waste.

DECLARATION OF CONFORMITY

DLS amplifiers for vehicles are manufactured in accordance with the EU directive EEC 95/54 (72/245/EEC) and are marked with the approval number. They are also marked in accordance with the WEEE-directive 2002/96/EC.

The products are also produced in accordance with the EU RoHS directive 2002/95/EC.

DLS Products are designed and engineered by:

DLS Svenska AB
Tagenevägen 11B, 422 59 Hisings Backa - Sweden
Tel: +46 31 840060
E-mail: info@dls.se
www.dls.se

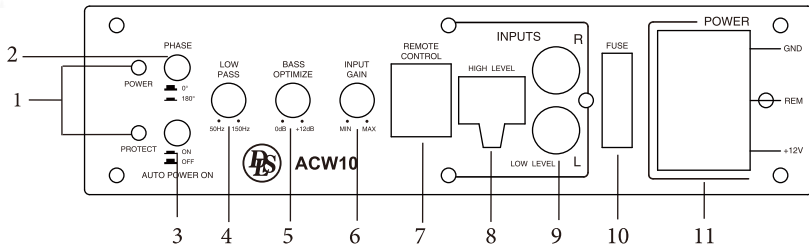

1. Power Status Led

This bi-color LED glows green when power is on and no problems are present. If one of the protection circuits comes on, it will change to red.

2. Phase Shift

Use this switch to help compensate for time alignment problems in the system. Such problems usually result from having the subwoofer at a different distance from the listener than the other speakers in the system.

3. Auto Power On

The auto power on (ON/OFF) is for high level (speaker-level) connections. When the switch is in the "ON" position, the subwoofer auto power on when there is signal input. If the amplifier detect no signal input, the amplifier will auto turn off. If you prefer to use the remote turn on/off connection, set the switch in the off position.

Note: Please connect the remote terminal to the remote output of head unit as Fig.4. When you turn on/off the head unit a receipt pulse can be heard from the subwoofer.

4. Low Pass Filter

This control permits you define the frequency range you want the subwoofer amplifier to receive. The subwoofer will reproduce all sound BELOW the frequency you set.

Note: The low pass filter frequency can be higher or lower than the visual scale.

5. Bass Optimize

The bass optimize controll feature will enable fine tune of the deepest bass frequencies.

6. Input Gain Control

After you have installed your system, turn this control to minimum. Turn the head unit on (and the subwoofer will turn on via the remote connection). Turn the head unit volume to about 2/3 full level. Slowly turn up the subwoofer input gain control until you hear a small amount of distortion. Then reduce the level until the distortion is completely gone. Leave the control at this setting.

7. Remote Level Control Port

Attach the included remote level control to control the volume level of the subwoofer from the dashboard.

8. High Level Input

If your head unit does not have RCA out-puts you can use the speaker outputs for the audio source for the subwoofer. Use the supplied cable and wire harness and connect the outputs properly as shown in the connection diagram.

9. Low Level Input

Low level inputs are the recommended way to input the audio signal to the subwoofer if RCA outputs are present on your head unit or other signal source (such as a sound processor).

10. Fuse

11. Power Input Terminal



NOTE: Do not connect BOTH the high level and low level inputs from your receiver to your amplifier at the same time .

Low Level Input Wiring

Low-level (RCA) input wiring is preferred for best audio performance. Most trunk or hatchback installations will require a 15-20 feet RCA cable, while pickup trucks and under-seat installations will require a 6-12 feet RCA cable. Always use a high quality cable.

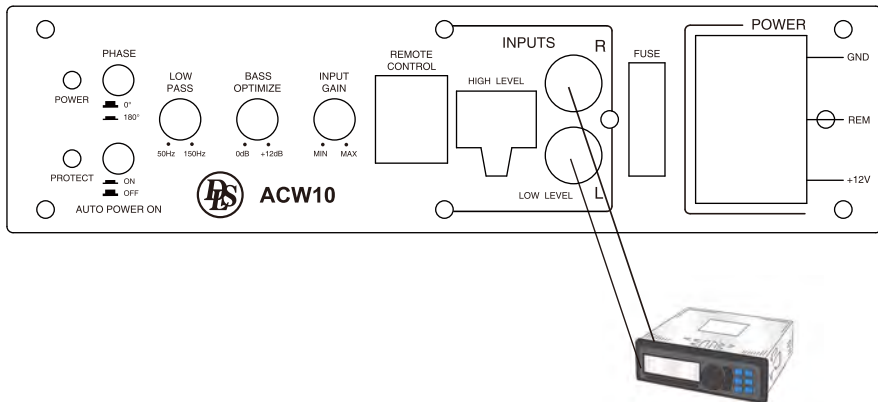

High Level Input Wiring

Most headunits are pre-installed from the car factory and have no RCA out-put, in this case you can use the signal from the speaker output. Connect left and right speaker wires coming from the car stereo to the high level input as shown. Be sure to observe polarity to avoid audio phase problems.

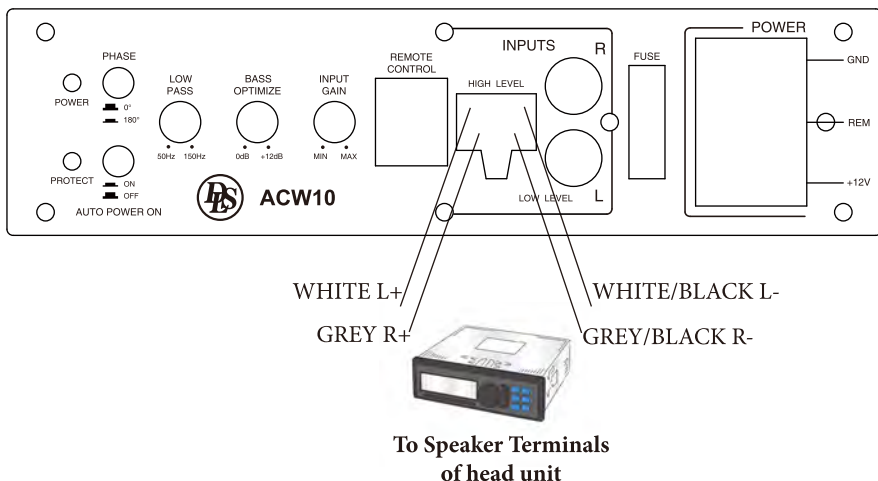



Power Terminal

Connect the fuse holder as close to the vehicle battery + as possible and connect the cable on the rear panel on the ACW10. Use a ring crimp terminal connector to battery.

Remote Terminal

Connect the remote terminal to the remote output of the head unit. This turns on the amplifier whenever the car stereo is turned on.

Ground Terminal

Connect to a good chassis ground. The ground connection should be clean, unpainted metal to provide a good electrical connection. Use a wire brush, a scraper or a piece of an abrasive sheet to clean the metal.

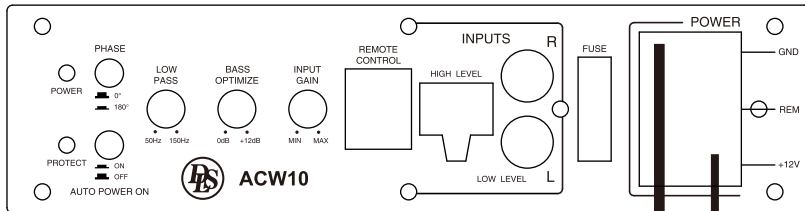

NOTE: In this connection, the AUTO TURN OFF switch is in the ON position.

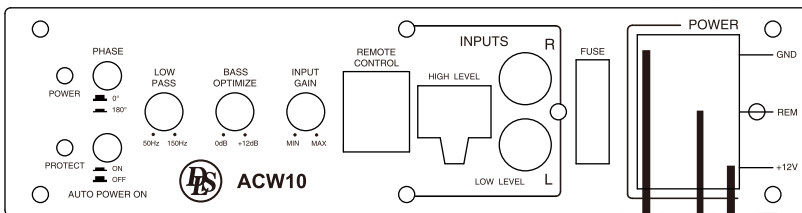
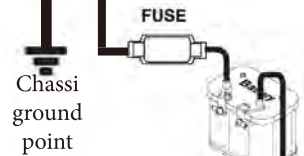

NOTE: In this connection, the AUTO TURN ON switch is in the OFF position.

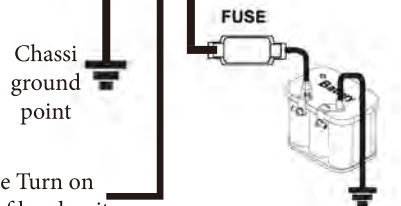



Installation

We include a fixing kit to ensure the subwoofer remains securely mounted. Two types of installation are possible.

Under the seat

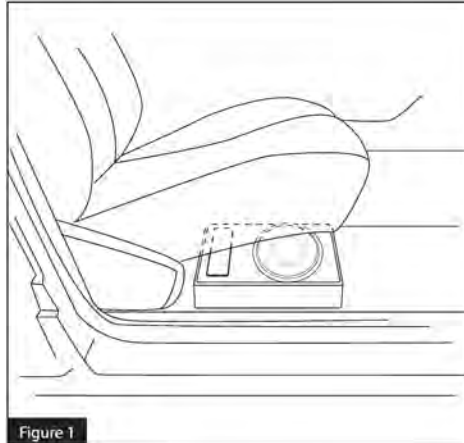

- 1 - The seat must be positioned in its normal fixed position.
- 2 - Decide the best location possible that suits your automobile and space available, checking that the enclosure doesn't restrict the seat mobility. (See Figure 1)
- 3 - Ensure the area for subwoofer location is clean and tidy. Any loose objects must be removed.
- 4 - Once the location has been decided, mark the screw hole positions for the fixing brackets.
- 5 - Drill holes of 2 mm for the 4 fixing brackets, at your defined locations.
- 6 - Fix the clamps to the subwoofer case with the four screws M6*8 (the fixing clamps have a mounting direction system) see (Figure 2 & 3)
- 7 - Position the subwoofer so that the holes correspond to the metal supplied screws and fix it. (Figure 4)
- 8 - Please make sure the subwoofer enclosure is tightly fixed.



Installation

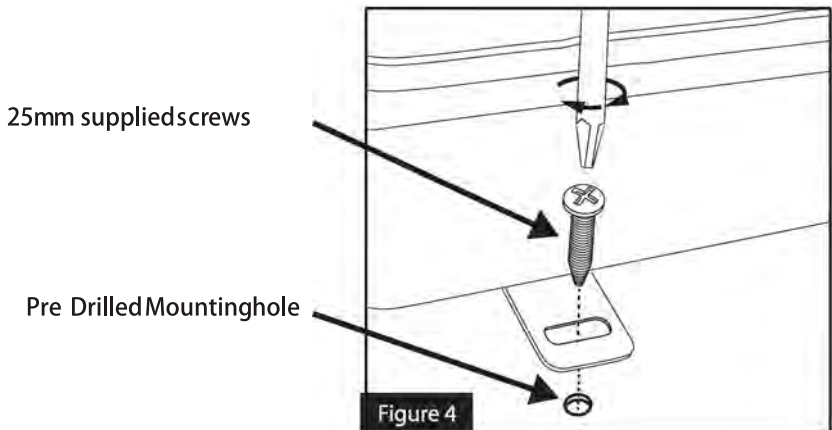
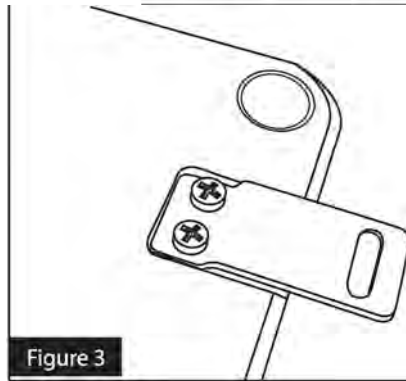
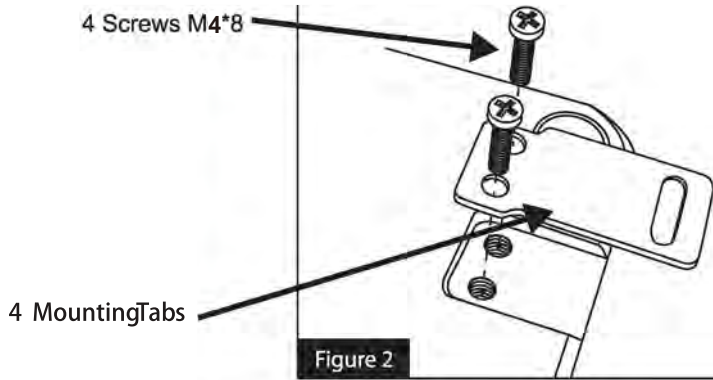



Installation

In the trunk

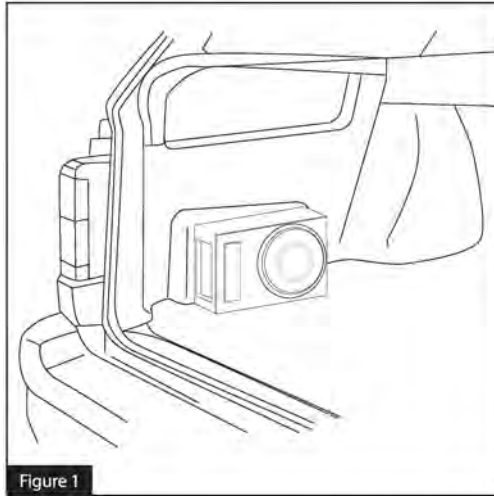

- 1 - Rear seats must be positioned in their normal fixed position.
- 2 - Decide the best location possible that suits your automobile and space available. The best and most secure location for optimum sound quality is behind the rear seats, in the trunk floor (see Figure 1).
- 3 - Ensure the area for subwoofer location is clean and tidy. Any loose objects must be removed, as they could knock and damage the subwoofer.
- 4 - Once the location has been decided, mark the screw hole positions for the fixing brackets.
- 5 - Drill holes of 2 mm for the 4 fixing brackets, at your defined locations.
- 6 - Fix the clamps to the subwoofer basket with the four screws M6*8 (the fixing clamps have a mounting direction system) see (Figure 2 & 3)



Installation

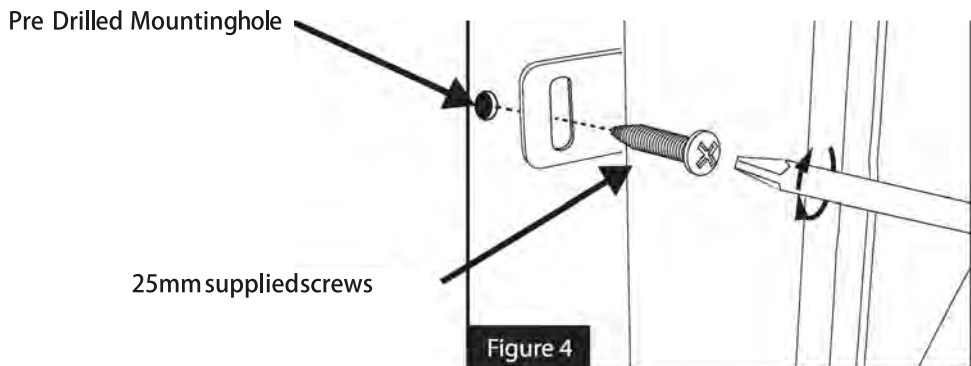
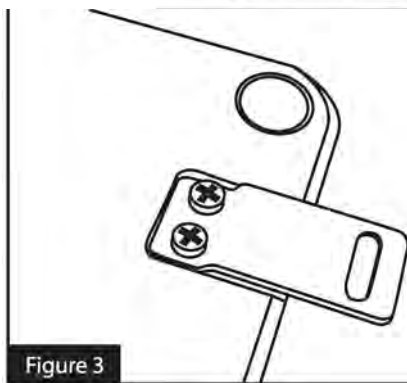
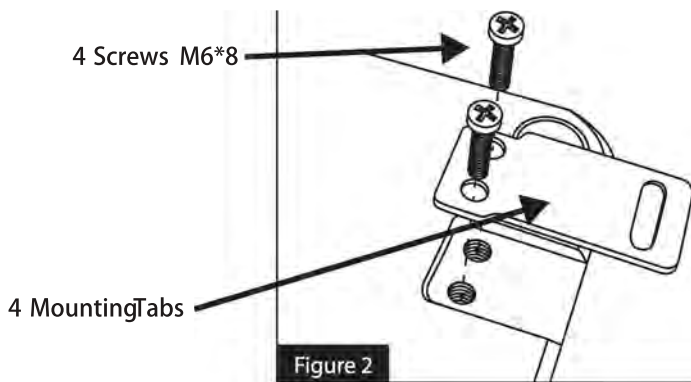



Troubleshooting Testing

If you experience operation or performance problems with this product, compare your installation with the electrical wiring diagram on the previous pages. If problems persist, read the following troubleshooting tips which may help eliminate the problems.

Amplifier will not power up.	Check to make sure you have a good ground connection. Check that the Remote Input {Turn-On) has at least 5VDC. Check that there is battery power on the (+) terminal. Check that there is at least 12v. Check all fuse, replace if necessary. Make sure that the Protection LED is not illuminated. If it is lit, shut off the amplifier briefly, and then repower it.
Protection LED comes on when amplifier is powered up.	Check for short circuits on speaker leads. Turn down the volume control on the head unit to prevent overdriving. Remote speaker leads, and reset the amplifier. If the Protection LED still comes on, then the amplifier is faulty and needs servicing.
No output.	Check that all fuses are OK. Check that unit is properly grounded. Check that the Remote Input {Turn-On) has at least 5VDC. Check that the RCA audio cables are plugged in to the proper inputs. Check all speaker wiring.
Low output.	Reset the Level control. Check the crossover control settings.
High hiss in the sound.	Disconnect all RCA inputs to the power sub's control panel. If the hiss disappears, then plug in the component driving the amplifier and unplug its inputs. If the hiss disappears at this point, go on until the faulty noisy component is found. It is best to set the amplifier's input level control as low as possible. The best subjective signal-to-noise ratio is achieved in this manner. Try to set the head unit as high as possible
Engine noise. (static type)	This is usually caused by poor quality RCA cables, which can pick up radiated noise. Use only the best quality cables, and route them away from power cables.
Engine noise. (alternator whine)	Check that the RCA grounds are not shorted to the vehicle chassis. Check that the head unit is properly grounded.
Amplifier gets very hot.	Check that there is good air circulation around the amp. In some applications, it may be necessary to add an external cooling fan.



Professional Tip:

NOISE PROBLEMS

WHINING NOISE VARYING WITH ENGINE REVOLUTIONS:

Do this:

1. Rewire the power supply (12 V) to source unit direct from battery.
2. Rewire ground wire from source unit to clean position on chassis.
3. Check all power connections to ensure that they are clean and tight.
4. Check quality of system ground connection.
5. Install a Power Cap capacitor. This can be helpful against most noise problems.

CONSTANT WHINING NOISE: Do this:

1. Ensure that all equipment has a common ground point.
2. Check quality of earth strap connection from battery negative terminal to chassis.
3. Disconnect signal cables from amplifier to see if noise disappears. If so the leads are picking up noise. Test this by laying a new cable over the seats and reconnecting to the amplifier. If the noise does not return, re-route original cable away from source of interference. If noise remains regardless of cable position, try to use so called Quasi-balanced signal cables. DLS PRO-cables are Quasibalanced.

Professional Tip:

Installing in trunk

When installing the amplifier in the trunk, run the power wires along the same path as the other vehicle wiring. Many cars have insulated channels for wiring. you will have to remove the door sill trim and the carpet.

Professional Tip:

SPEAKER POLARITY CHECK.

All speakers in a car audio system should be connected in phase (the same polarity). All speaker cones must move in the same direction. Out of phase speakers will cause a lack of bass, and a poor stereo soundstage.

Checking polarity:

Hold the connection of the speaker wire to the terminal of a 1,5 Volt flashlight battery. Tap the + wire on to the + terminal of the battery, and observe the movement of the cone. The cone should move outwards when the wire touches the battery, and inwards when the battery is removed. If it is the other way around, the speaker has been connected backwards and it must be removed and connected correctly. If your system also has a subwoofer connected through a passive 6 or 12 dB crossover, try to connect this with various polarity and judge what sounds best. The phase shift in passive crossovers sometimes makes it necessary to change polarity.

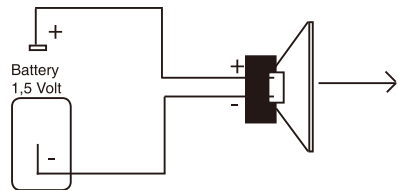

NOTE! Tweeters can not be tested this way, double check the connections instead.

Professional Tip:

Speaker and power wires

Do not run speaker and power wires next to each other. Power wires can generate a "siren" sound in the speakers. Run speaker and power wires on opposite sides of the car.



A product from
DLS - Sweden

Specifications

MODEL:	DLS ACW10
Power:	200W RMS/450W
THD	MAX <0.4%
Signal-to-noise ratio	>90dB
Frequency response	30Hz - 150Hz
Input sensitivity, high level	0.9V
Input sensitivity, low level	300mV
Low Pass Filter	50Hz - 150Hz
Bass optimized	0to+12dB
Subsonic Filter	30Hz
Fuse rating	25A
Subwoofer	10inch, 2ohm
Dimensions(L x W x H) inches/mm	13.6" (345) X 9.6" (245) X 2.6" (68)

We follow a policy of continuous advancement in development. For this reason all or part of specifications & designs may be changed without prior notice.

www.dls.se