

1.

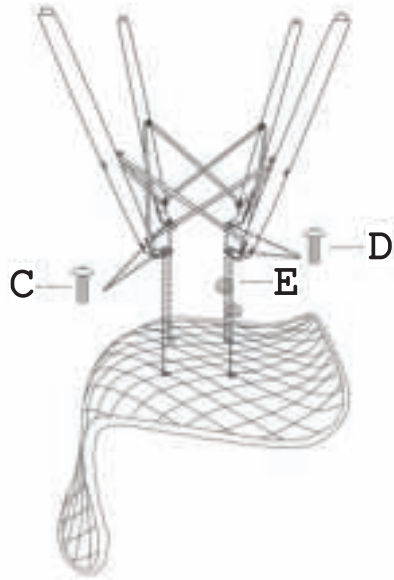

3.

1100263

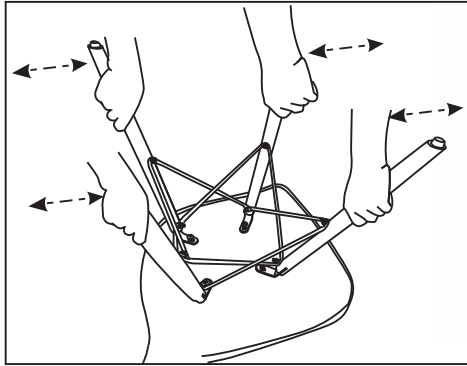
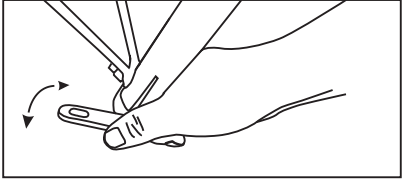
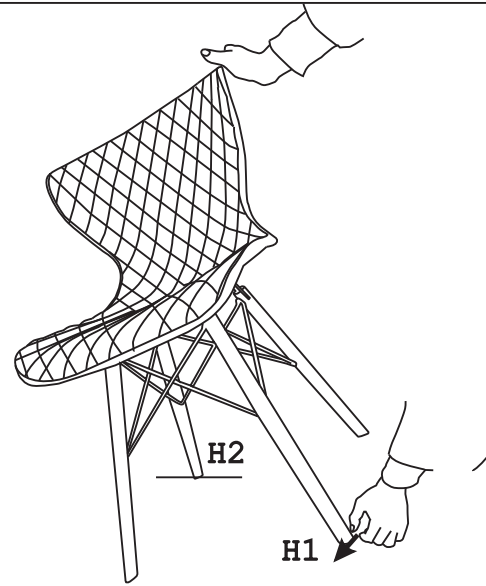

NOTE:

If leg H1 is not close to the ground like step 2 after assembled, please lift chair and put H2 on the floor like step 3. Push leg H1 to H2 or pull to opposite direction until four legs at the same level.

2.

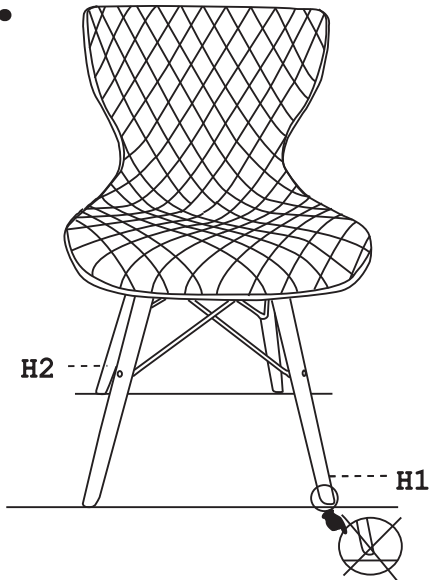

4.

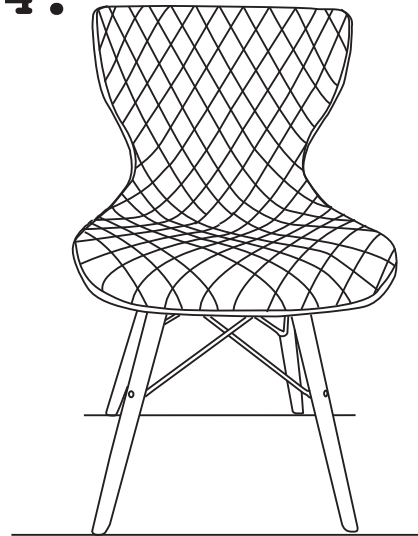

5.

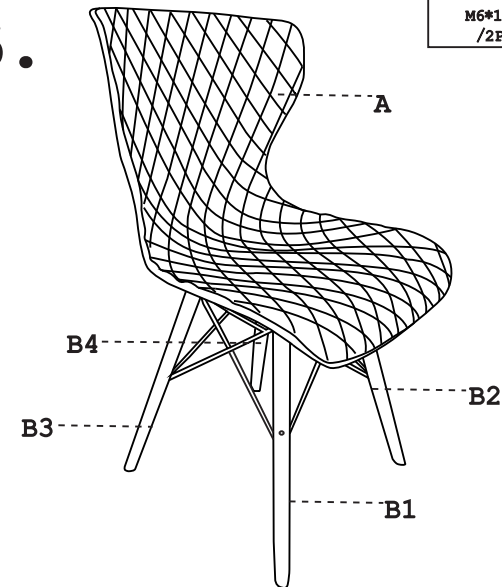

C	D	E	F
M6*12MM /2PCS	M6*20MM /2PCS	Φ20*9*5MM /2PCS	M5/1PC