

bopita®

ASSEMBLY INSTRUCTION
MONTAGE HANDLEIDING
MONTAGE ANLEITUNG
NOTICE DE MONTAGE
MANUAL DE MONTAJE

UK
NL
D
F
ESP

MODEL
TYPE
COLOUR
ART.CODE

:CARO
:PLAYPEN
:NATURAL
:110042.01

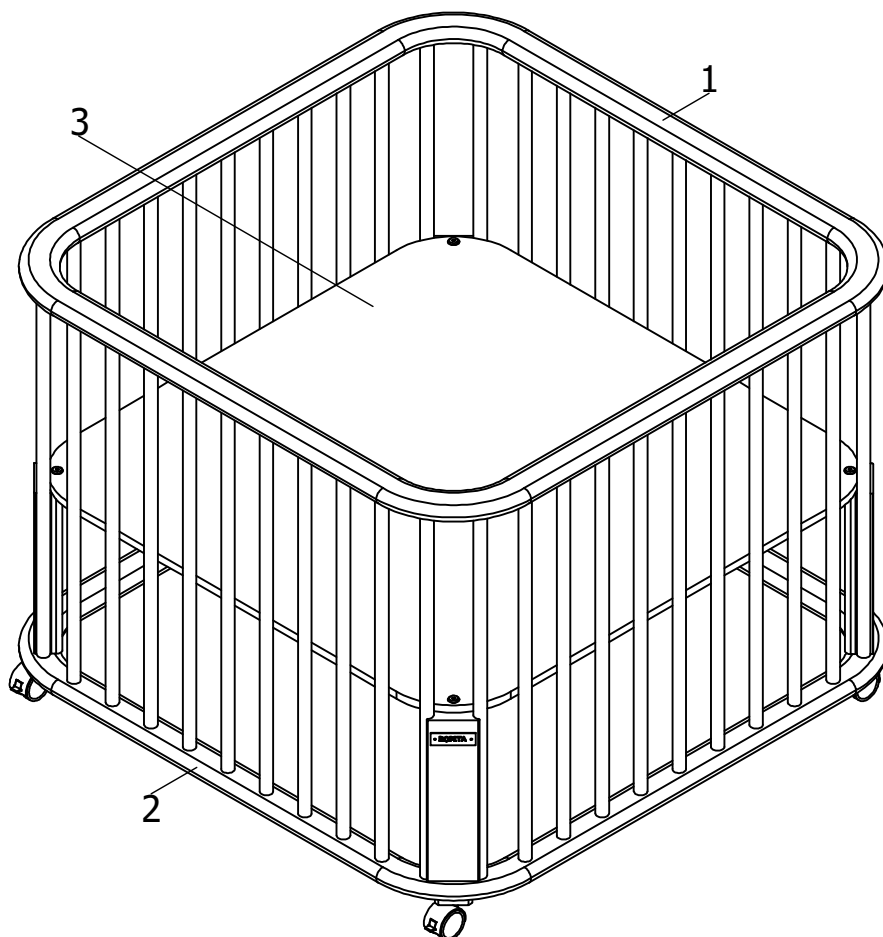



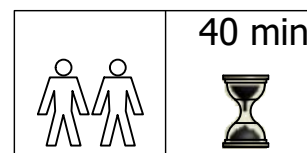

Distributor:

BOPITA
Energieweg 1
6662 NS Elst
The Netherlands

www.bopita.com



27.03.2023.

<p>A</p>  <p>M6x30 44X</p>	<p>B</p>  <p>M6X35 4X</p>	<p>C</p>  <p>M6 4X</p>	<p>D</p>  <p>4X</p>	<p>E</p>  <p>4X</p>
---	--	---	---	--

