



# INSTALLATIEHANDLEIDING

Stage2 624

Stage2 634

Stage2 424

Stage2 9634





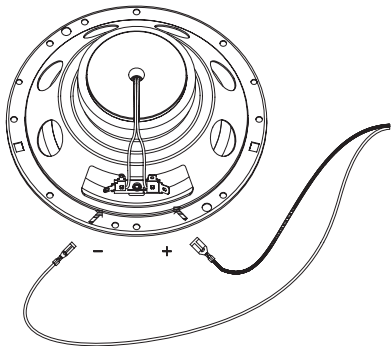
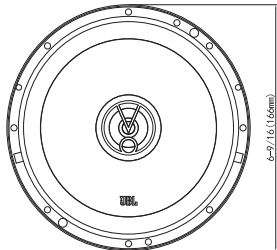
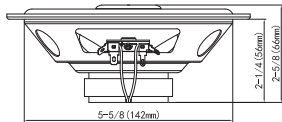

Stage2 604C

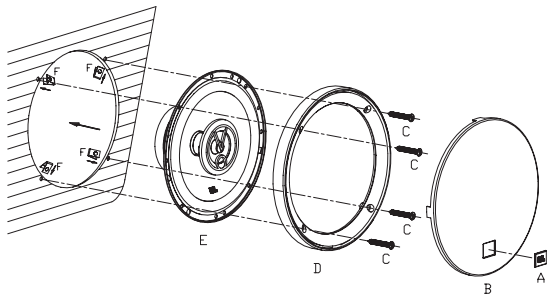
Stage2 524

# Stage2 624





|  |  |  |  |  |  |
|--|--|--|--|--|--|
| <p>A</p>  <p>2x</p> | <p>B</p>  <p>2x</p> | <p>C</p>  <p>8x</p> | <p>D</p>  <p>2x</p> | <p>E</p>  <p>2x</p> | <p>F</p>  <p>8x</p> |
|--|--|--|--|--|--|

## Specificaties

- Type: 6-1/2" (160 mm) tweewegs coaxiale autoluidspreker
- Vermogensverwerking: 40 Wrms, 240 W piek
- Gevoeligheid (bij 2,83 V): 91 dB
- Frequentiebereik: 55 Hz - 20 kHz
- Nominale impedantie: 4 ohm



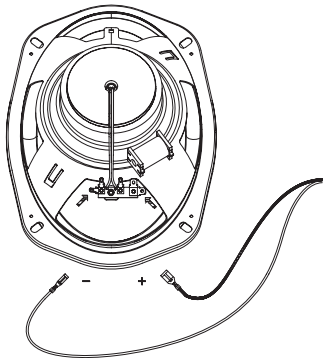
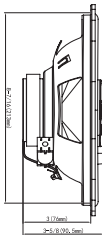
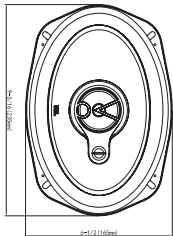
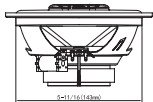

## Thiele-Small Parameters

- BL (Tm): 3.241
- DCR (ohm): 3.2
- Mms (g): 8.031
- Sd (cm<sup>2</sup>): 128.68
- Cms (µm/N): 427.874
- Vas (l): 10.061
- Fs (Hz): 85
- Qes: 1.32
- Qms: 4.242
- Qts: 1.007
- Crossover Point: 4.6 kHz

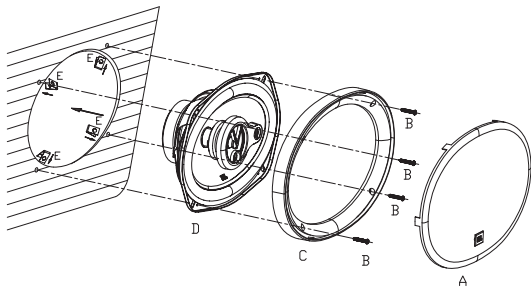
# Stage2 9634





|  |  |  |   |  |
|--|--|--|---|--|
| <p>A</p>  <p>2x</p> | <p>B</p>  <p>8x</p> | <p>C</p>  <p>2x</p> | <p>D</p>  <p>2x</p> | <p>E</p>  <p>8x</p> |
|--|--|--|---|--|

## Specificaties

- Type: 6" x 9" (152 mm x 230 mm) driewegs autoluidspreker
- Vermogensverwerking: 70 Wrms, 420 W piek
- Gevoeligheid (bij 2,83 V): 92 dB
- Frequentiebereik: 50 Hz – 21 kHz
- Nominale impedantie: 4 ohm

## Thiele-Small Parameters





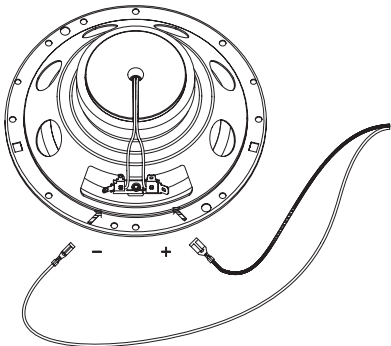
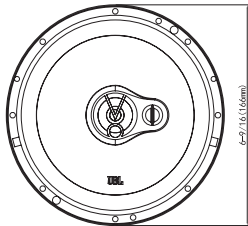
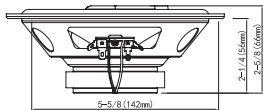

- BL (Tm): 3.496
- DCR (ohm): 2.3
- Mms (g): 17.755
- Sd (cm<sup>2</sup>): 213.565
- Cms (µm/N): 306.333
- Vas (l): 19.84
- Fs (Hz): 70
- Qes: 1.432
- Qms: 3.99
- Qts: 1.054
- Crossover Point: 3.6 kHz

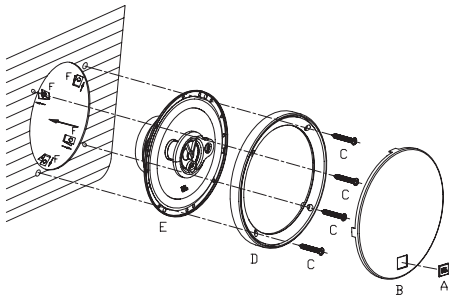
# Stage2 634







|  |  |  |  |  |  |
|--|--|--|--|--|--|
| <p>A</p>  <p>2x</p> | <p>B</p>  <p>2x</p> | <p>C</p>  <p>8x</p> | <p>D</p>  <p>2x</p> | <p>E</p>  <p>2x</p> | <p>F</p>  <p>8x</p> |
|--|--|--|--|--|--|

## Specificaties

- Type: 6-1/2" (160 mm) driewegs autoluidspreker
- Vermogensverwerking: 40 Wrms, 250 W piek
- Gevoeligheid (bij 2,83 V): 91 dB
- Frequentiebereik: 55 Hz - 20 kHz
- Nominale impedantie: 4 ohm

## Thiele-Small Parameters





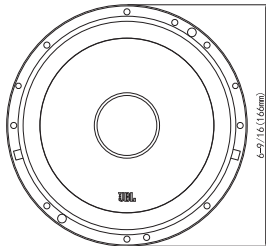
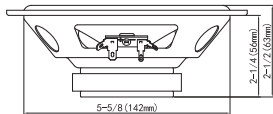

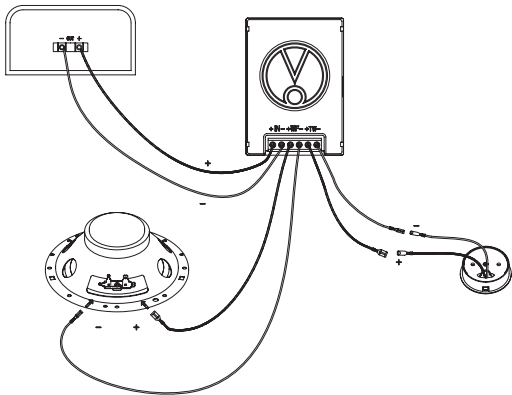

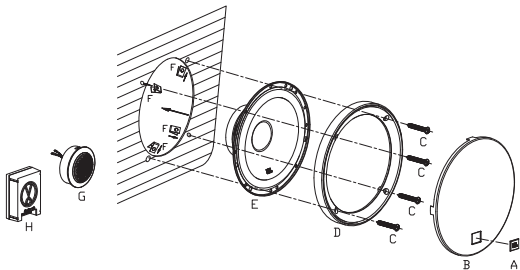
- BL (Tm): 3.241
- DCR (ohm): 3.2
- Mms (g): 8.031
- Sd (cm<sup>2</sup>): 128.68
- Cms (µm/N): 427.874
- Vas (l): 10.061
- Fs (Hz): 85
- Qes: 1.32
- Qms: 4.242
- Qts: 1.007
- Crossover Point: 4.2 kHz

# Stage2 604C







|  |  |  |  |  |  |  |  |
|--|--|--|--|--|--|--|--|
| <p>A</p>  <p>2x</p> | <p>B</p>  <p>2x</p> | <p>C</p>  <p>8x</p> | <p>D</p>  <p>2x</p> | <p>E</p>  <p>2x</p> | <p>F</p>  <p>4x</p> | <p>G</p>  <p>2x</p> | <p>H</p>  <p>2x</p> |
|--|--|--|--|--|--|--|--|

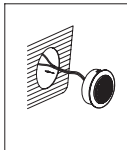

## Specificaties

- Type: 6-1/2" (160 mm) tweewegs componentluidsprekersysteem
- Vermogensverwerking: 45 Wrms, 270 W piek
- Gevoeligheid (bij 2,83 V): 91 dB
- Frequentiebereik: 55 Hz - 20 kHz
- Impedantie: 4 ohm



## Thiele-Small Parameters

- BL (Tm): 3.588
- DCR (ohm): 3.2
- Mms (g): 11.01
- Sd (cm<sup>2</sup>): 128.68
- Cms (µm/N): 348.261
- Vas (l): 8.189
- Fs (Hz): 85
- Qes: 1.398
- Qms: 3.618
- Qts: 1.008
- Crossover Point: 5.8 kHz

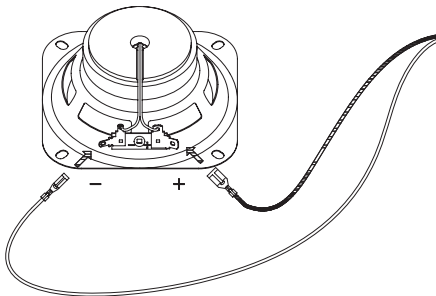
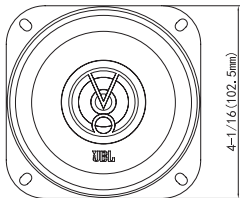
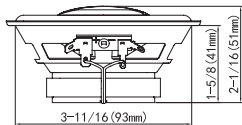
# Stage2 424

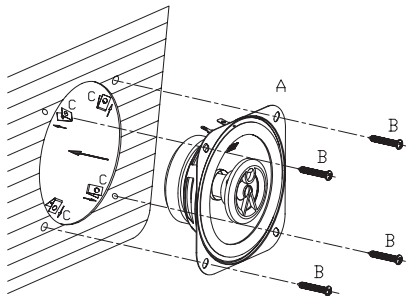



|  |  |  |
|--|--|--|
| <p>A</p>  <p>2x</p> | <p>B</p>  <p>8x</p> | <p>C</p>  <p>8x</p> |
|--|--|--|



## Specificaties

- Type: 4" (100 mm) tweewegs autoluidspreker
- Vermogensverwerking: 25 Wrms, 150 W piek
- Gevoeligheid (bij 2,83 V): 88 dB
- Frequentiebereik: 75 Hz - 20 kHz
- Nominale impedantie: 4 ohm



## Thiele-Small Parameters

- BL (Tm): 2.965
- DCR (ohm): 3.2
- Mms (g): 4.629
- Sd (cm<sup>2</sup>): 55.389
- Cms (µm/N): 409.235
- Vas (l): 1.785
- Fs (Hz): 115
- Qes: 1.224
- Qms: 4.583
- Qts: 0.966
- Crossover Point: 6.6 kHz

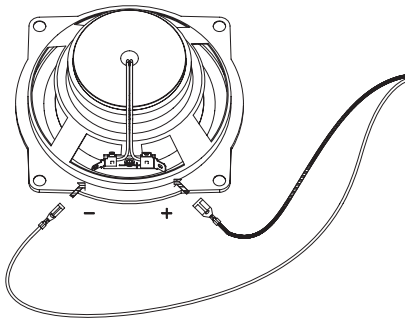
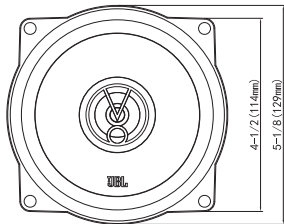
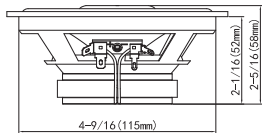
# Stage2 524

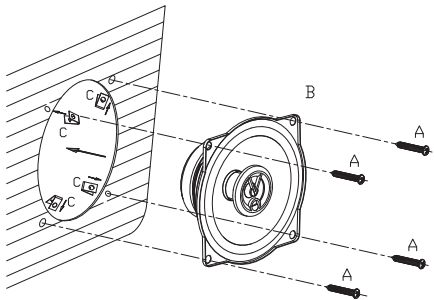



|  |  |  |
|--|--|--|
| A<br><br>8x | B<br><br>2x | C<br><br>8x |
|--|--|--|

## Specificaties

- Type: 5-1/4" (130 mm) tweewegs autoluidspreker
- Vermogensverwerking: 35 Wrms, 210 W piek
- Gevoeligheid (bij 2,83 V): 90 dB
- Frequentiebereik: 75 Hz - 20 kHz
- Nominale impedantie: 4 ohm

## Thiele-Small Parameters

- BL (Tm): 3.11
- DCR (ohm): 3.2
- Mms (g): 5.269
- Sd (cm<sup>2</sup>): 81.71
- Cms (μm/N): 506.563
- Vas (l): 4.803
- Fs (Hz): 95
- Qes: 1.067
- Qms: 4.525
- Qts: 0.864
- Crossover Point: 5.8 kHz



HARMAN International Industries,  
Incorporated

8500 Balboa Boulevard,  
Northridge, CA 91329 USA

© 2019 HARMAN International  
Industries, Incorporated.

Alle rechten voorbehouden.

JBL is een handelsmerk van HARMAN International Industries, Incorporated, gedeponeerd in de Verenigde Staten en/of andere landen.

Opties, specificaties en vormgeving kunnen worden gewijzigd zonder voorafgaande kennisgeving.