















SAFETY INSTRUCTION

Please study the instruction manual and below information carefully before installing or using this product. Please keep this user manual for further reference

- The luminaires may only be installed by authorized and qualified technicians according to the valid regulations for electrical installation.
- Maintenance of the luminaires is limited to their surfaces. During maintenance no moisture can come into contact with any areas of the terminal connections or voltage control parts.
- The electrical supply must be switched off at the outset, preferably by means of a switch in the distribution box, before any installation, maintenance or repair work is undertaken.
- Exterior lighting must not be installed during rain.
- Take account of the minimal separation distance from other objects and the room required around the fitting.
- If in any doubt, consult a professional, taking local installation requirements into account. Some countries stipulate that lighting may be installed only by registered installers.
- Clamping screws in electrical connections must be adequately tightened. This is particularly the case with 12V low voltage conductors.
- When replacing a halogen lamp, wait for it to cool, for a minimum of 5 minutes.
- Clean with a clean, dry cloth or brush, use no solvents or abrasives. Avoid dampness on all electrical components
- Take account of all available technical information.
- Take note of the symbols when connecting wires:
N = Neutral **L = Live** **⊕ = Earth**
- Meaning of symbols:

-  For indoor use only, where direct contact with water is impossible
-  This icon indicates the level of water-proof and dust-proof
-  Protection Class I: the fitting must be earthed
-  Protection Class II: the fitting is doubled insulated and does not require earthing
-  Protection Class III: the fitting is low voltage
-  Minimum distance from lighted objects (meters)
-  Only the self-shielded halogen lamp should be used with the luminaire
-  Strip the wire to the indicated length (mm); different items require different length
-  Connect using the specified cable; different items require different cables
-  The type of lamp and maximum size and wattage indicated in each lighting unit must not be exceeded; different items require different kind of light sources with different bulb icons
-  The armature is designed to work only with the indicated voltage. Different items require different working voltage.
-  The luminaire can be used in combination with a dimmer
-  The reference light angle and light space of the luminaire
-  This luminaire cannot be disposed together with normal domestic waste in standard rubbish can, but you have to bring it to a staging area for electrical waste

INSTRUCTION MANUAL



Duo WL
93909/93910/99497

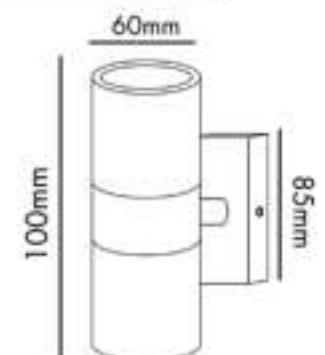
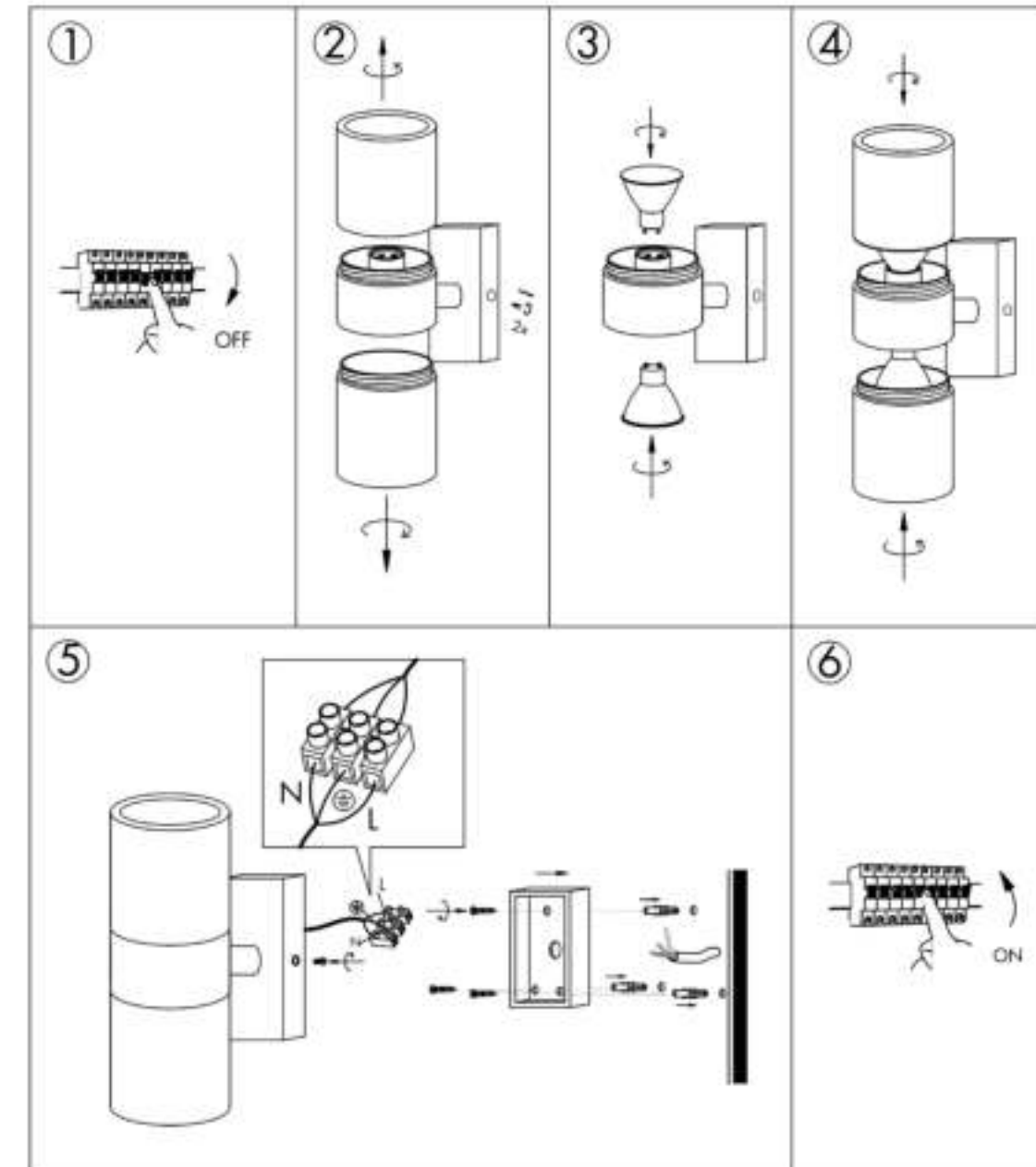



Wi-Fi & Bluetooth Smart Bulb GU10 Manual

02505



FEATURES

- Wi-Fi & Bluetooth connection
- Voice control
- Timer switch
- Grouping
- Full range of W / W+WW / RGBW / RGBWW available
- No Hub required
- Remote control
- Sync with music

PARAMETERS

COLOR	INPUT VOLTAGE	Current(mA)	Base	Power(W)
CW	EU	80	E27	9
CCT	AC220-240V 50Hz	80		9
RGBW		80		9
RGB+CCT		80		9

WIRING DIAGRAM

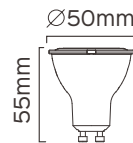

DOWNLOAD APP

1: Search "Tuya Smart" from App store or Google play.

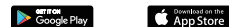

2: Scan the QR code from the label or user

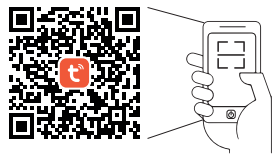

The APP is compatible with Android 4.0 and IOS8.1 and higher version.



LOG IN / REGISTER ACCOUNT NUMBER

Open the Tuya Smart APP, sign up for a new account or log in with an existing account.

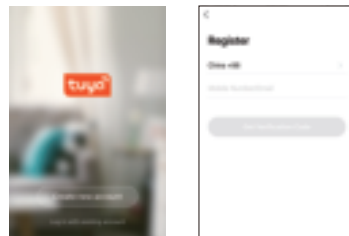

DEVICE PAIRING-EASY IN

1. Turn on the Smart Bulb and enter the home of APP while ensure Bluetooth on and the WIFI signal is good and stable.
2. Smart Bulb will flashing when turn on the power supply. Stay at the home page and found the push notification, then click Go to add.
3. Select the Wi-Fi connected to the smart device, input the Wi-Fi password, and then click "Next" to wait for the matching to succeed. (Make sure smart devices share the same Wi-Fi)

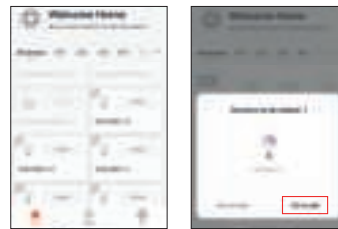

Stay at the Home Page Push Notification



Add Device Enter/Confirm Wi-Fi Password

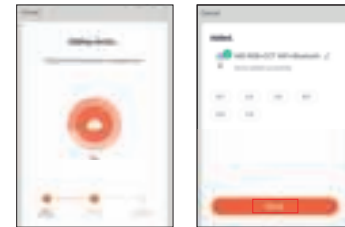

Connecting Pairing Successful

DEVICE PAIRING-AUTO SCAN

1. Turn on the Smart Bulb and enter the home of APP while ensure Bluetooth on and the WIFI signal is good and stable.
2. Smart Bulb will flashing when turn on the power supply. Stay at the home page and enter the APP adding device interface, click Auto Scan to find the device then click next.
3. Select the Wi-Fi connected to the smart device, input the Wi-Fi password, and then click "Confirm" to wait for the matching to succeed. (Make sure smart devices share the same Wi-Fi)

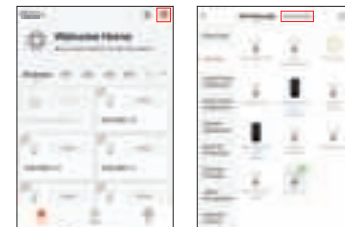

Stay at the Home Page Push Notification

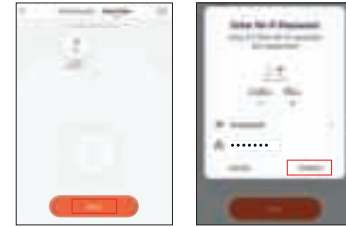

Scan Devices Enter/Confirm Wi-Fi Password

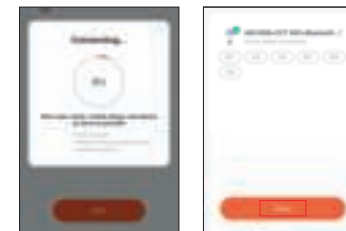

Connecting Pairing Successful

DEVICE PAIRING-BLUETOOTH MANUALLY

1. Turn on the Smart Bulb and enter the home of APP while ensure Bluetooth on and the WIFI signal is good and stable.
2. Smart Bulb will flashing when turn on the power supply. Stay at the home page and enter the APP adding lighting device interface, click "Lighting(Bluetooth)".
3. If the Smart Bulb is not flashing when turn on the power supply, long press the Reset button for more than 6 seconds. While Smart Bulb flashing, select "confirm the light has flashed",

4. then click "Next". Select the Wi-Fi connected to the smart device, input the Wi-Fi password, and then click "Next" to wait for the matching to succeed.

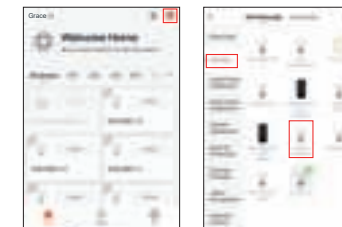

Stay at the Home Page Manually Bluetooth

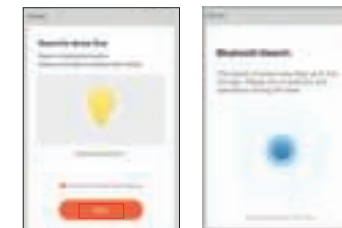

Searching Searching

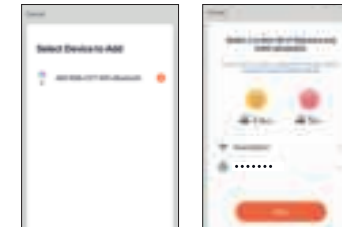

Add Device Enter/Confirm Wi-Fi Password

DEVICE PAIRING-AP PAIRING

1. Turn on the Smart Bulb and enter the home of APP while ensure Bluetooth on and the WIFI signal is good and stable.
2. Smart Bulb will flashing when turn on the power supply. Stay at the home page and enter the APP adding lighting device interface, click "Lighting(BLE+Wi-Fi)".
3. If the Smart Bulb is not flashing when turn on the power supply, long press the Reset button for more than 6 seconds. While Smart Bulb flashing, select "confirm the light has flashed",
4. then click "Next". Select the Hotspot connected to the smart device, input the Wi-Fi password, and then click "Next" to wait for the matching to succeed. (Make sure smart devices share the same Wi-Fi)



Manually Wi-Fi



Select AP Mode

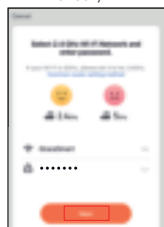

Enter/Confirm Wi-Fi Password

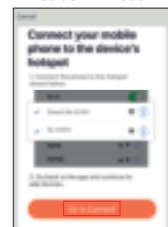

Confirm Hotspot



Select Hotspot



Connecting

CONTROL DEVICE

After the device is connected successfully, tap "Device" at the bottom. The device name of the smart lamp shows in the list. Tap it to enter the control panel of the smart lamp.

1. White mode: Adjust brightness and color temperature of white light.



9.

2. Color mode: Adjust color, brightness, saturation

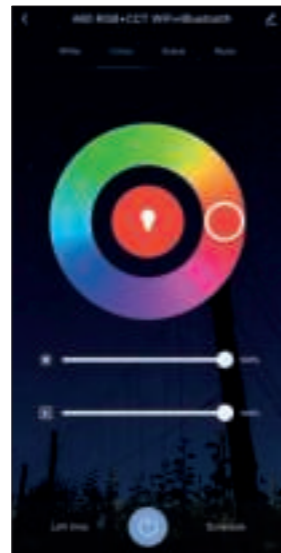

10.

3. Scene mode: Eight scenes modes (4 static & 4 dynamic).



11.

4. Schedule: This will keep the bulb in ON/OFF position for a specific duration of time.



12.

5. Grouping: If you got two or more light, please tap "..." at the upper right corner of the control panel and create group. The smart lamp group will realize synchronous switch, color changes, the scene mode selection, timer, etc.



13.

6. Music mode: You can minimize the Tramsmart App to play music from any source. Your Smart Bulb will automatically synchronize and change color to the music.

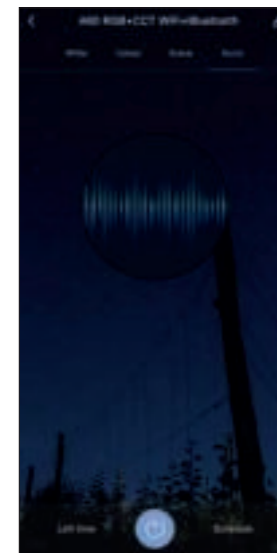

14.

APP FUNCTION INTRODUCTION

Click the interface to control it according to the specific mode of the specific Smart Bulb. The following is public function introduction.

- Remote control: The Smart Bulb can be controlled anywhere after the smart device is successfully
- Timer function: Set the timer to turn on and turn off the Smart Bulb.
- Intelligent scene: The system sets a variety of intelligent scenes, and different scenes correspond to different
- Group: Group control is available(only for the same type of product). Family room management.
- Device Sharing: The device is shared with other user control devices in the home.

THIRD PARTY CONTROL

In the Tuya Smart APP: Find more service in "Me" menu, click to enter "voice service" (Alexa/ Google Assistant) and other services, click on the service you need. Connect to the third-party service device according to the operation guide.

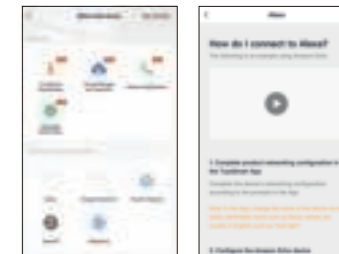

For any product and APP updating, please contact with customer service.

15.

16.