

## WiFi Atmosphere light

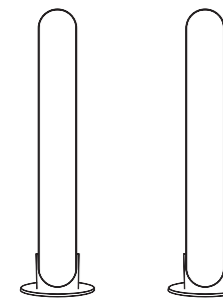

Please read this manual carefully before using the product, and keep it for records properly.



### Product Description

The desktop atmosphere light is a lighting device controlled by a mobile APP. Joint Tuya Smart Life APP to enter interactive interface, using plus buttons. Key control mode realizes the switching of phantom lights to meet the user's distance Manipulation. The function of each button is clear, and the APP interactive interface is simple and generous.

### Product Features

- Mobile APP control
- Music mode
- Timed
- USB interface

### 2 Pack

### Product Parameter

Product Name: WiFi Atmosphere light  
 Model: HCP20514  
 Working voltage: 5V  
 Working current: 1 A  
 Rated power: 5W+0.5W

### Product Specifications

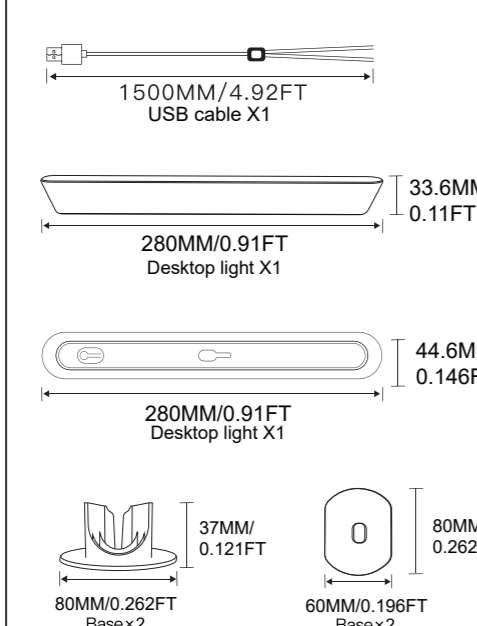

### Product Installation



### Connection Diagram

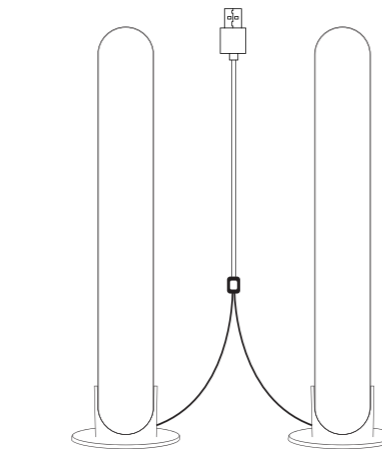

### Key Description

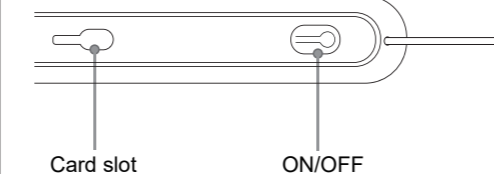

- ON/OFF: Double tap to turn on and off the light, Long press 5S to enter the red light, flashing Mobile phone pairing, realize APP control.
- Align the bracket with the card slot, and then push it up to complete.

### Download and install "Gvvo Home" APP



Scan QR code to download APP or search "Gvvo Home" on Google Play or APP store Download it. This APP supports Android 4.3 and above | IOS 8.0 and above.

### APP Operation

Click the Gvvo Home APP icon



### How to connect a smart device to the APP

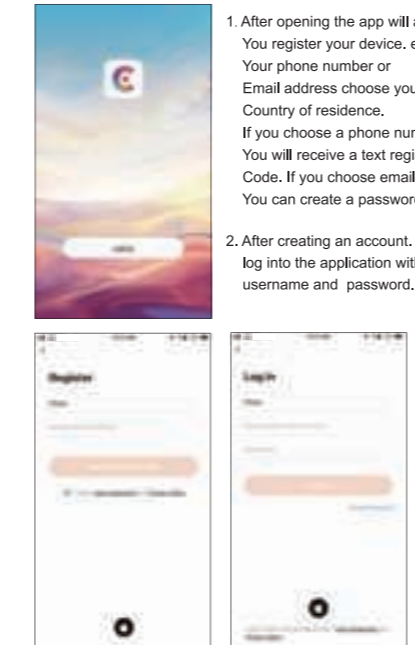

- After opening the app will ask You register your device, enter Your phone number or Email address choose you Country of residence. If you choose a phone number You will receive a text registration Code. If you choose email, You can create a password.
- After creating an account, please Log into the application with your username and password.

### 3. Connection method 1

When connecting the product, please keep the phone and the product at Click "Gvvo Home page" within 15 meters Please keep within 15 meters The icon "+" in the upper right corner selects "Auto Discovery", Wait for 3-6 seconds to search for products. After the search is successful, the product will automatically pop up. Then click Next to connect



**important hint**  
 When the first user successfully connects to the product, If the second user needs to connect to the product, The first user must remove the device from the phone, New user to re-configure network, click "Gvvo home page" The icon "+" in the upper right corner selects "Auto Discovery" and waits for 3-6 seconds to search for products. After the search is successful, the product will automatically pop up, and then click Next to connect

### 4. Connection method 2

When connecting the product, the phone and the product Please keep within 15 meters Click the icon "+" in the upper right corner of "Gvvo Home page" Select "LED night light", Then select the number: HCP20514 to connect



**important hint**  
 When the first user successfully connects to the product, If the second user needs to connect to the product, The first user must remove the device from the phone, New user to re-configure network, click "Gvvo home page" The icon "+" in the upper right corner selects "Auto Discovery" and waits for 3-6 seconds to search for products. After the search is successful, the product will automatically pop up, and then click Next to connect

### 4. Connection method 2

When connecting the product, the phone and the product Please keep within 15 meters Click the icon "+" in the upper right corner of "Gvvo Home page" Select "LED night light", Then select the number: HCP20514 to connect



**important hint**  
 When the first user successfully connects to the product, If the second user needs to connect to the product, The first user must remove the device from the phone, New user to re-configure network, click "Gvvo home page" The icon "+" in the upper right corner selects "Auto Discovery" and waits for 3-6 seconds to search for products. After the search is successful, the product will automatically pop up, and then click Next to connect

### APP control interface

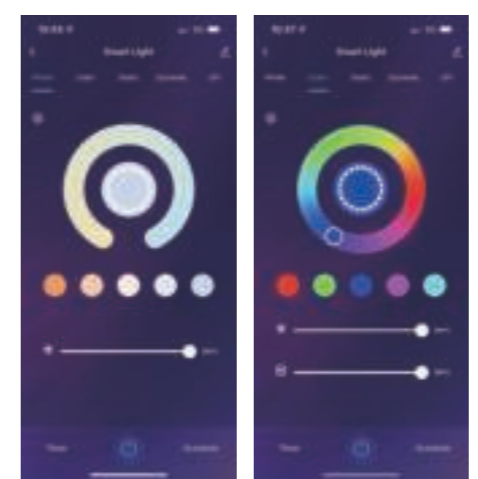

- White light interface Cool/warm color adjustment bright adjustment
- IPL interface 16 million color adjustments bright adjustment



- Static interface 12 static light effects bright adjustment
- Dynamic interface 12 dynamic light effects Adjustable light brightness and speed

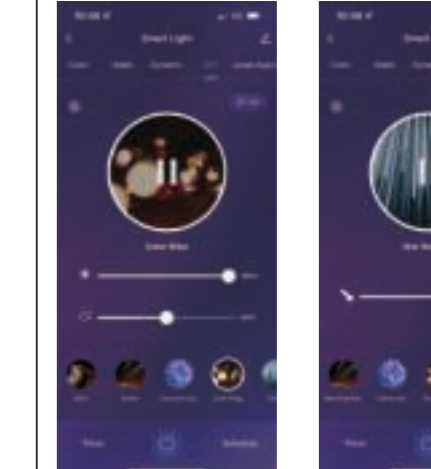

- DIY interface 12 lighting effects Mobile phone playing music The lighting will change with the music Adjustable brightness and speed
- Local music interface 12 lighting effects The lights will follow Outside sound changes

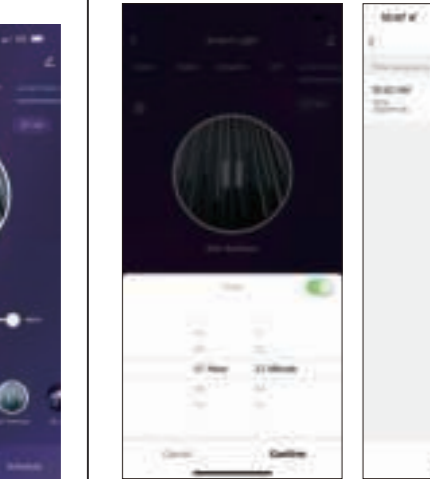

- Countdown mode Select the time light will only be The selected time zone lights up Arrive at the specified time Countdown to turn off the lights
- Light alarm mode Can specify time Lights on and off