

Model 223-I / Model 234-I  
Model 238-I







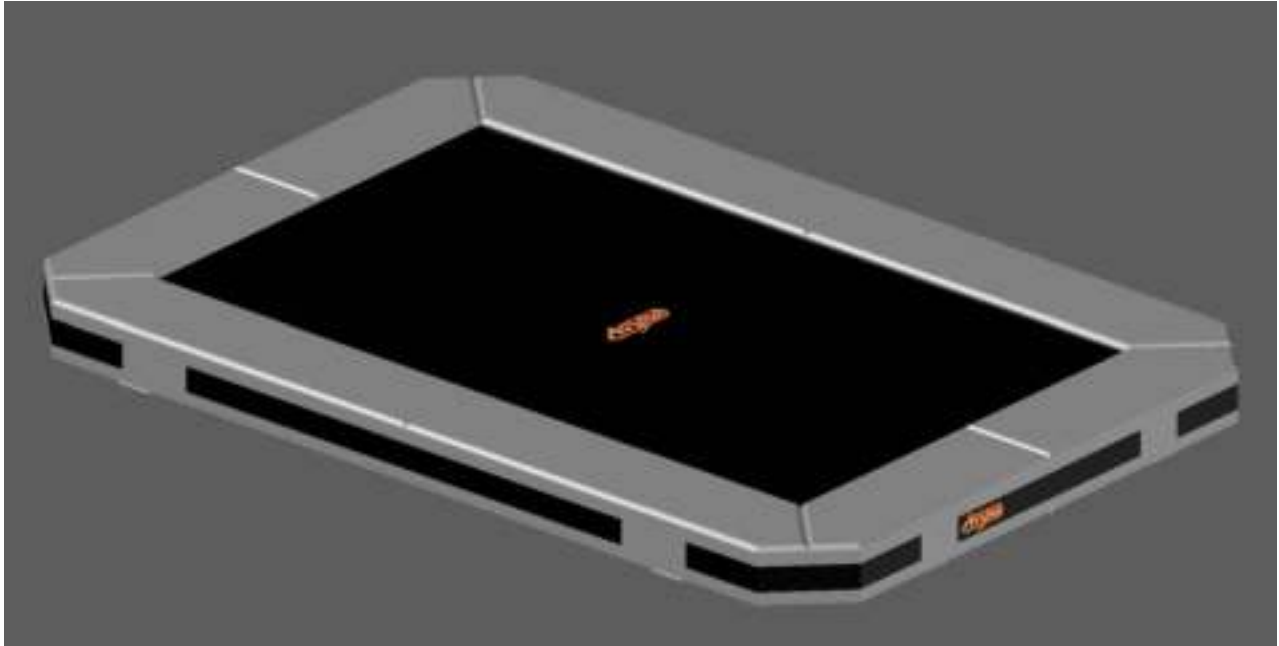

*Avyna*





# Rectangular trampolines

## Assembly manual

Model 223-I / Model 234-I  
Model 238-I



		Model 223-I APPROX 305x225cm		Model 234-I APPROX 340x240cm		Model 238-I APPROX 380x255cm	
		Quantity	Part number	Quantity	Part number	Quantity	Part number
Jumping mat		1	TEPL-223-I-222	1	TEPL-234-I-222	1	TEPL-238-I-222
Galvanized spring L=215mm Ø3.2mm			TEPL-200-211/A	78	TEPL-200-211/A	90	TEPL-200-211/A
Galvanized spring L=175mm Ø3.2mm		74	TEPL-200-211/C	4	TEPL-200-211/C	4	TEPL-200-211/C
Galvanized spring L=140mm Ø3.2mm		4	TEPL-200-211/E				
Safety pad		1	TEPL-223-I-333-green or AVGR-223-I-333-grey or CAM-223-I-333-camouflage OR AVBL-223-I-black	1	TEPL-234-I-333-green or AVGR-234-I-333-grey or CAM-234-I-333-camouflage OR AVBL-234-I-black	1	TEPL-238-I-333-green or AVGR-238-I-333-grey or CAM-238-I-333-camouflage or AVBL-238-I-333-black
Fastener for Safety pad		8	TEPL-ELAS-A	12	TEPL-ELAS-A	12	TEPL-ELAS-A
Inground pin		8	TEPL-PIN	8	TEPL-PIN	8	TEPL-PIN
K-tube		2	TEPL-223-1141	2	TEPL-234-1141	2	TEPL-238-1141

		Model 223-I APPROX 305x225cm		Model 234-I APPROX 340x240cm		Model 238-I APPROX 380x255cm	
		Quantity	Part number	Quantity	Part number	Quantity	Part number
C-tube		2	TEPL-223-112	2	TEPL-234-112	2	TEPL-238-112
Tool for spring		1	TOOL-SPRING	1	TOOL-SPRING	1	TOOL-SPRING
Inground pin		8	TEPL-SP-PIN	12	TEPL-SP-PIN	12	TEPL-SP-PIN
Fastener for Safety pad		20	TEPL-ELAS-B	20	TEPL-ELAS-B	20	TEPL-ELAS-B
Users Manual		1	208010101	1	208010101	1	208010101
Warning Card		1	208040101	1	208040101	1	208040101
Tie rip for warning card		1	209010102	1	209010102	1	209010102
Safety manual		1	208010301	1	208010301	1	208010301

1.

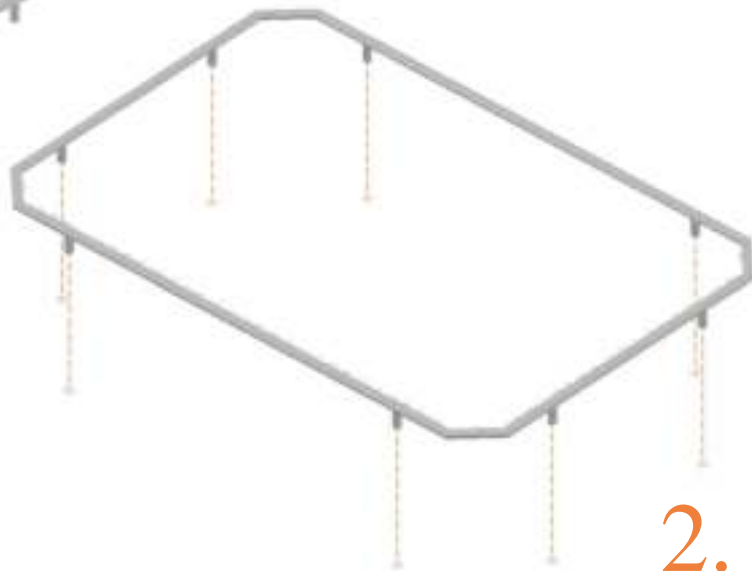
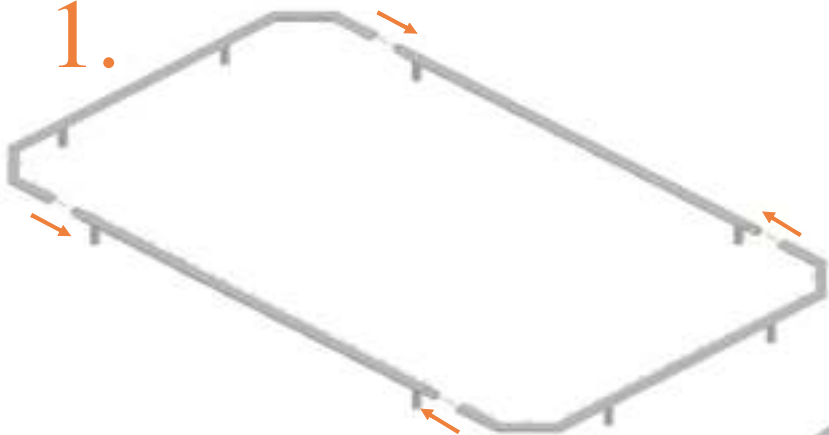

2.

3.



223-I : Max 20cm  
234-I / 238-I : Max 25cm

223-I : Min 60cm  
234-I / 238-I : Min 80cm

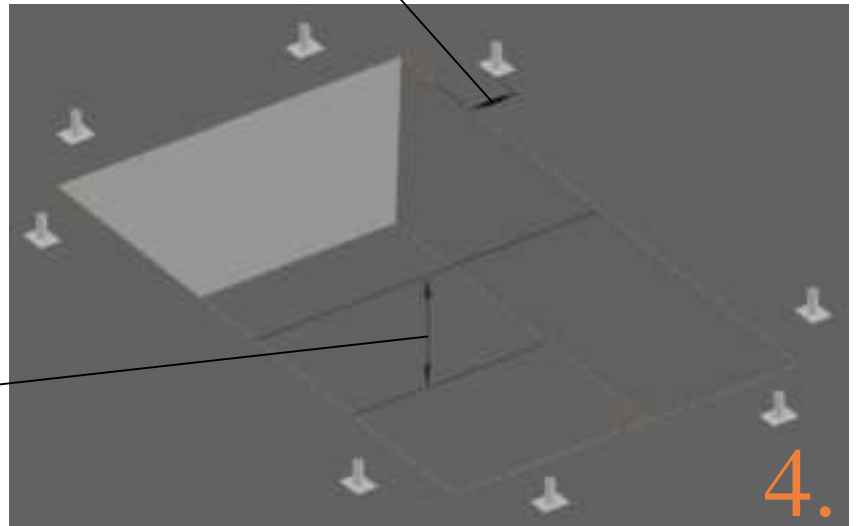

4.

5.

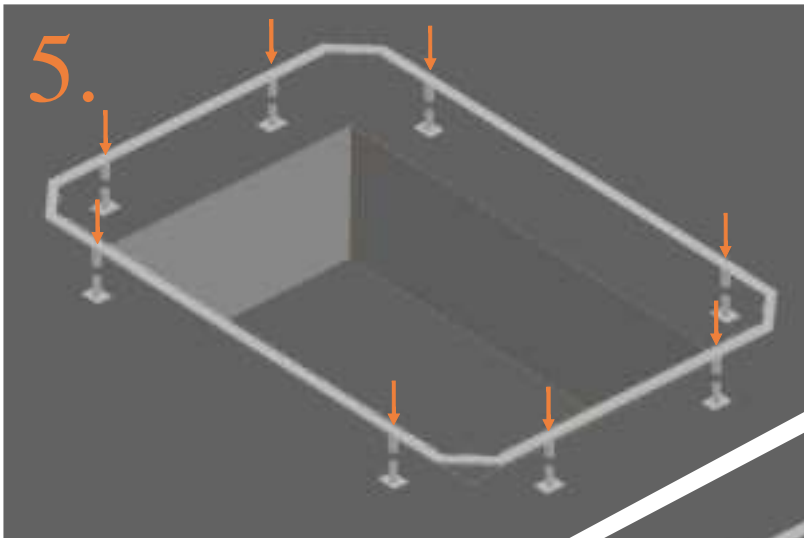

223: 4x spring 140mm  
234 / 238 :4x spring 175mm

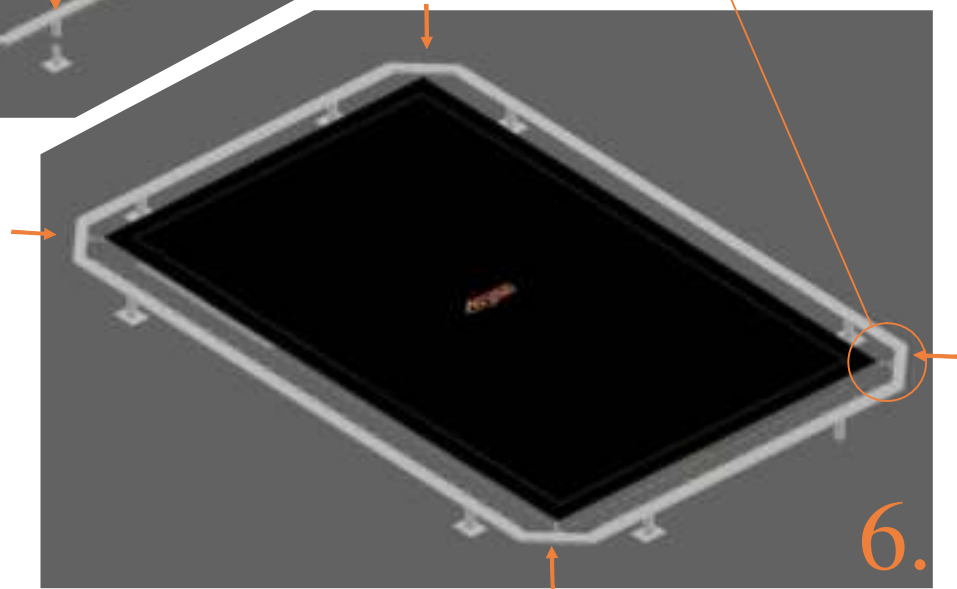
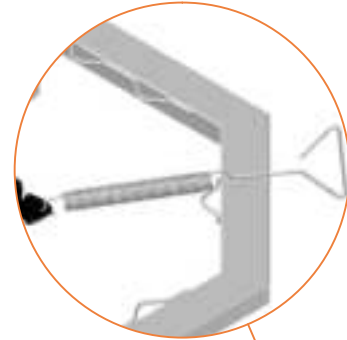

6.

7.

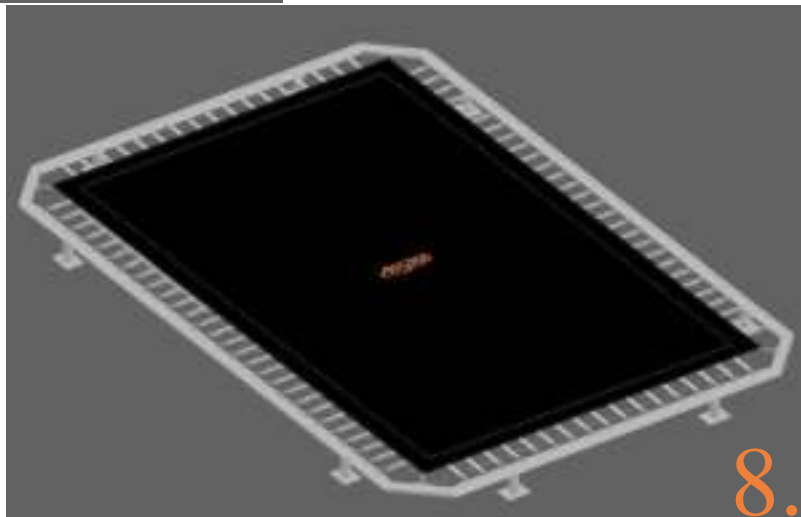
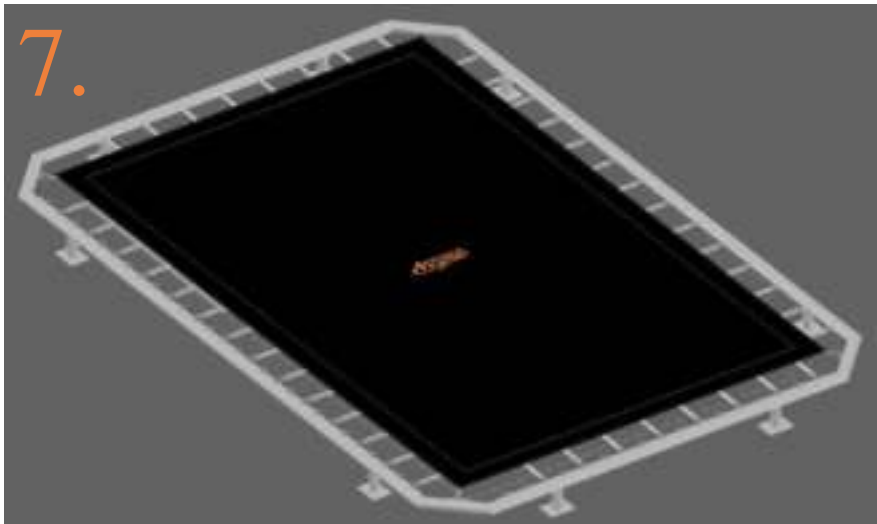

8.



9.

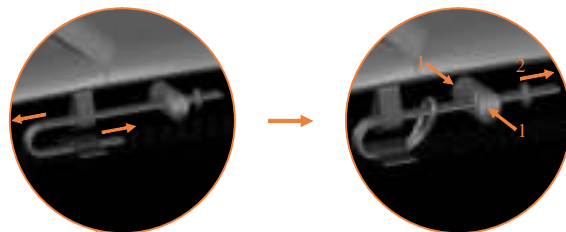
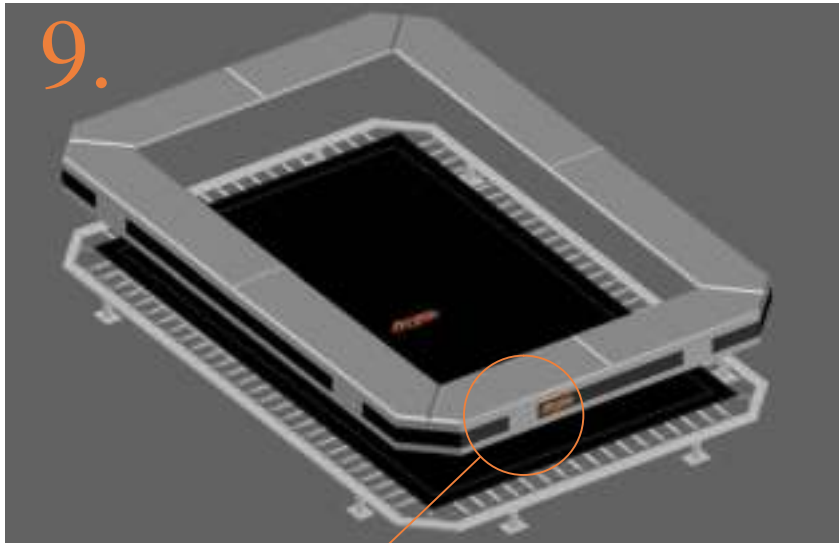

TEPL-ELAS-B



TEPL-ELAS-B

TEPL-ELAS-A 223-i : 8x  
234-i / 238-i: 12x

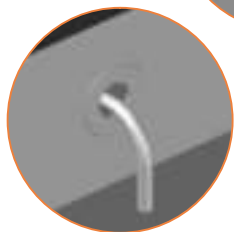
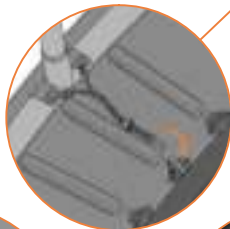



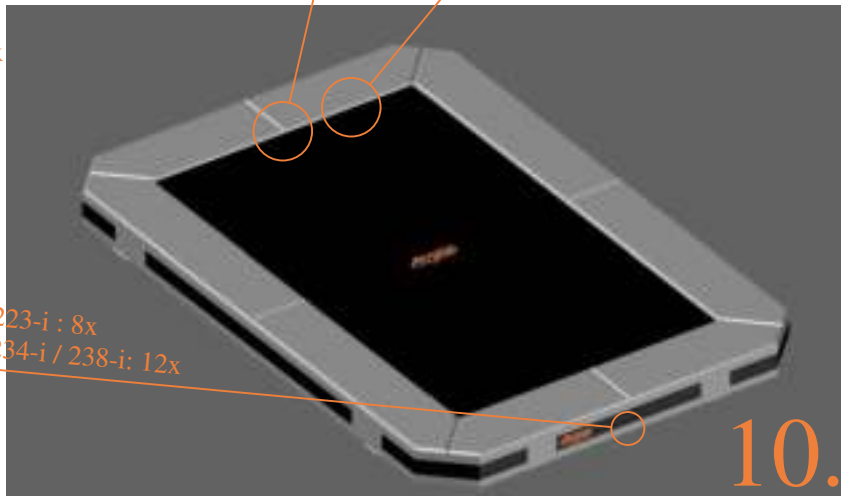



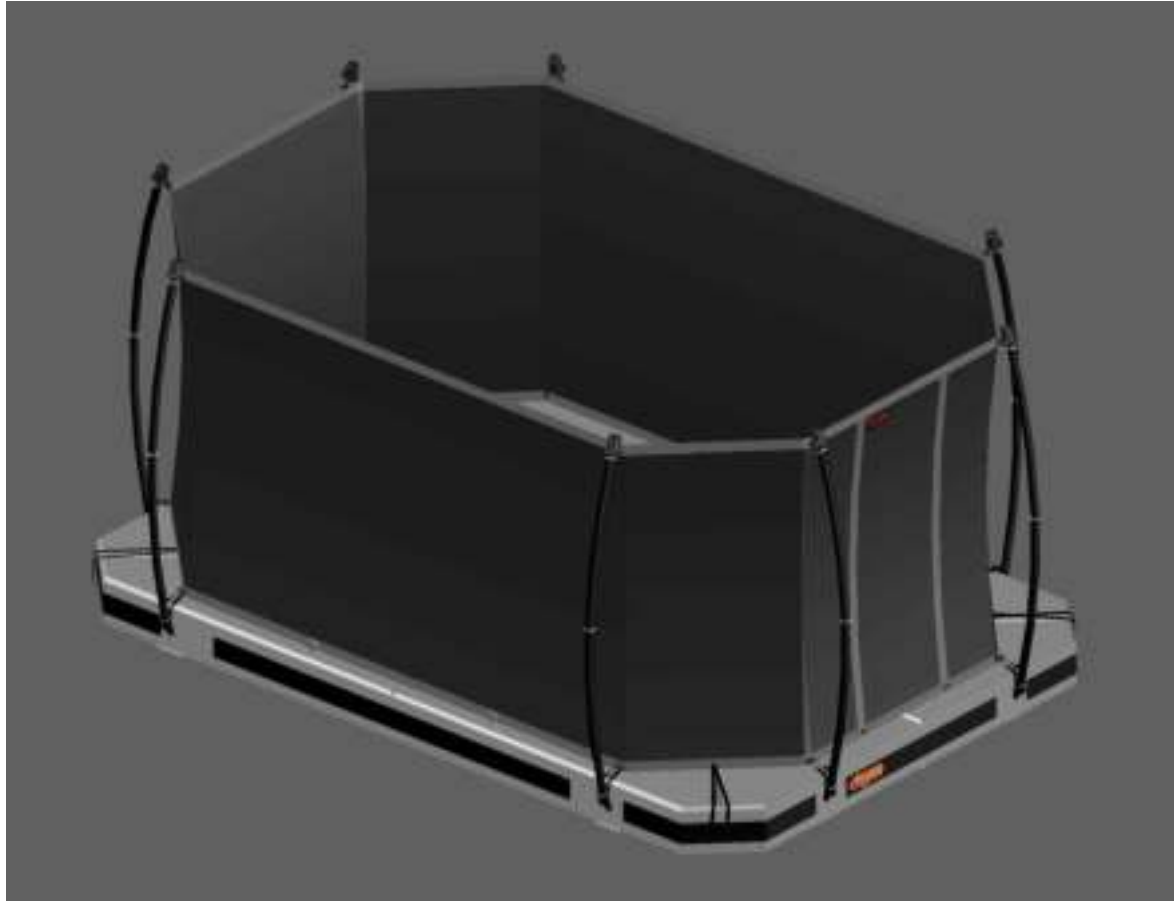

223-i : 8x  
234-i / 238-i: 12x



10.

# Model 223-I / Model 234-I / Model 238-I



		Model-223-I APPROX 305x225cm		Model-234-I APPROX 340x240cm		Model-238-I APPROX 380x255cm	
		Quantity	Part number	Quantity	Part number	Quantity	Part number
Pole with sleeve for safety net		8	AVBL-223-i-802 A	8	AVBL-234-i-802 A	8	AVBL-238-i-802 A
Pole for safety net		8	AVBL-223-i-802 B	8	AVBL-234-i-802 B	8	AVBL-238-i-802 B
Clamp		8	CLAMP-TOOL-SN 223-i	8	CLAMP-TOOL-SN 234-i	8	CLAMP-TOOL-SN 238-i
Screw M6x30		8	M6x30	8	M6x30	8	M6x30
Safety net		1	ANBL-223-I	1	ANBL-234-I	1	ANBL-238-I
Straps for safety net		20	TEPL-BAND 16x short: 1,0m 4x long: 1,5m	20	TEPL-BAND 16x short: 1,0m 4x long: 1,5m	20	TEPL-BAND 16x short: 1,0m 4x long: 1,5m
Closure for safety net		2	TEPL-KNOOPJE	2	TEPL-KNOOPJE	2	TEPL-KNOOPJE
Fastening for safety net		10	TEPL-ELAS-C	10	TEPL-ELAS-C	10	TEPL-ELASTIEK
Screw M8		16	M8-25	16	M8-25	16	M8-25
Allen key		2	ALLEN-KEY	2	ALLEN-KEY	2	ALLEN-KEY
Wrench		2	WRENCH	2	WRENCH	2	WRENCH

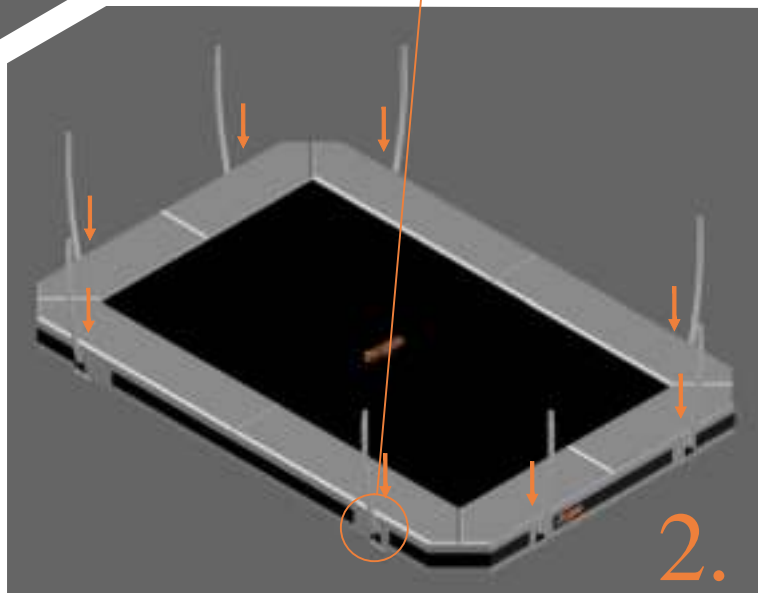
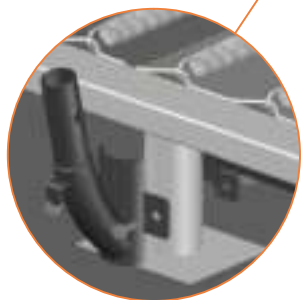
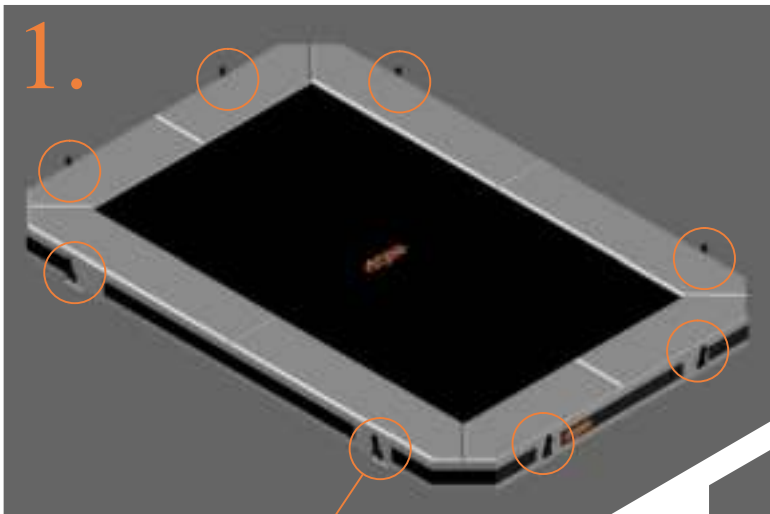

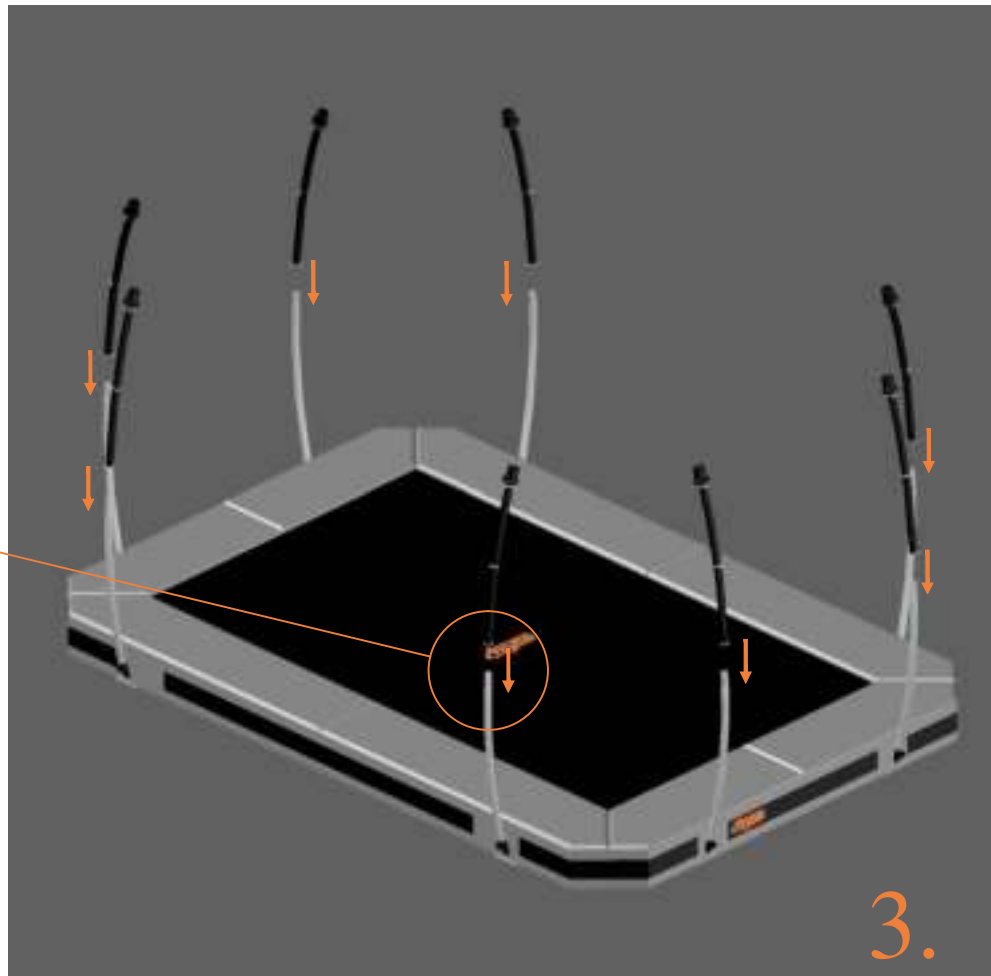

4.



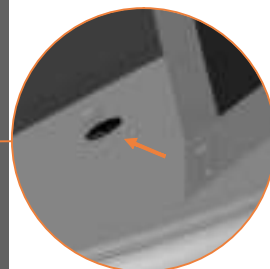
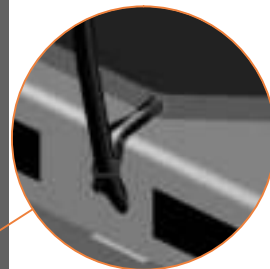
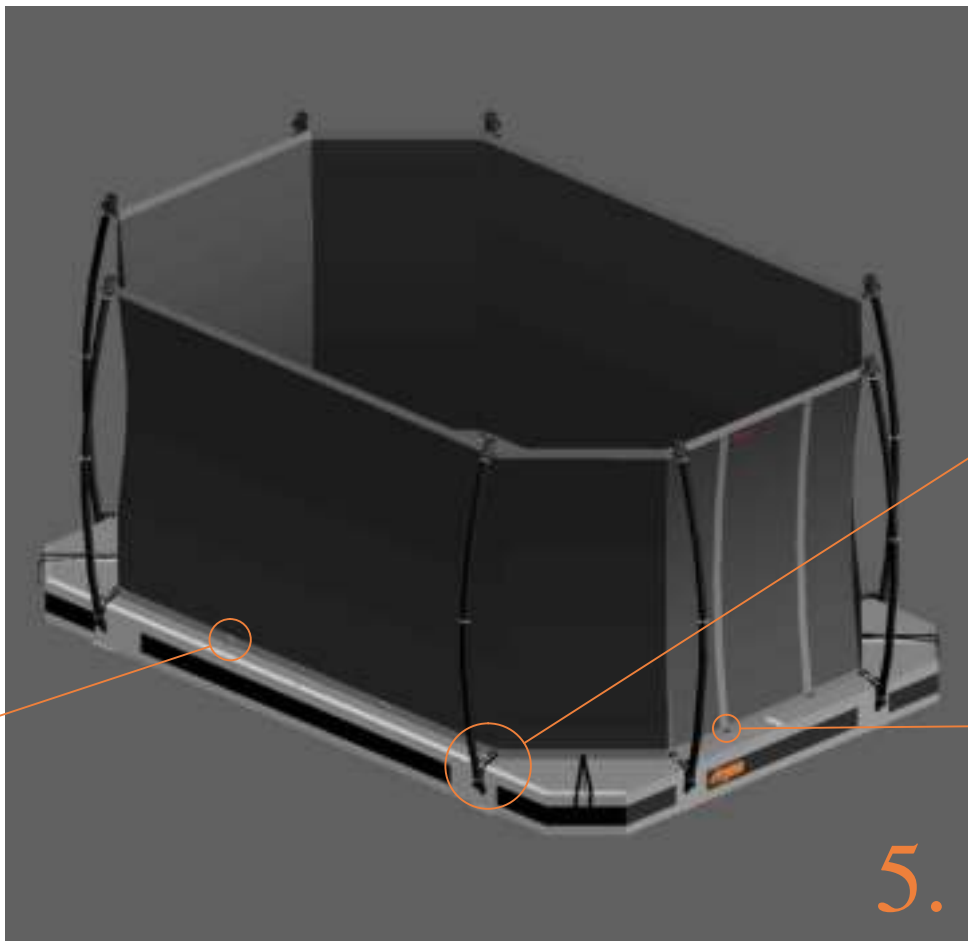
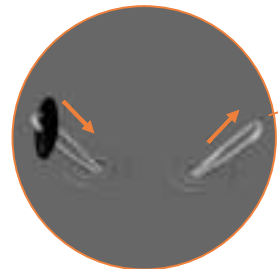
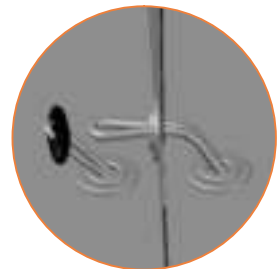

TEPL-ELAS-C

5.



Sales office: Beneluxbaan 7  
5121 DC Rijen  
The Netherlands  
[sales@avyna.eu](mailto:sales@avyna.eu)  
[www.avyna.eu](http://www.avyna.eu)