

Instruction Manual

Thank you for purchasing this product.
Before using this product, please read the instructions carefully.
After reading the instruction manual, please keep it for reference.

Caution



Caution

**Parents/Guardians:
Please read the following information carefully.**

- This product contains small parts. Keep away from children under 3 years old.
- Keep this product away from small children or infants. Seek medical attention immediately if any small parts are swallowed.
- Long cord. Strangulation hazard.
- Keep the product away from dusty or humid areas.
- Do not use this product if it has been damaged or modified.
- Do not get this product wet. This may cause an electric shock or malfunction.
- Do not place this product near heat sources or leave under direct sunlight for an extended period. Overheating may cause malfunction.
- Do not touch the metal parts of the USB plug.
- Do not apply strong impact or weight on the product.
- Do not pull roughly or bend the cable of the product.
- Do not disassemble, modify or attempt to repair this product.
- If product needs cleaning, use only a soft dry cloth. Do not use any chemical agents like benzene or thinner.
- Do not use this product for anything other than its intended purpose. We are not responsible for any accidents or damages in the event of use other than the intended purpose.

Included



Steering unit x1



Foot pedals x1

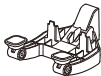

Clamp x1



Screw x1

Platform

PlayStation®5 console / PlayStation®4 console / PC

System requirements	USB Port, Internet Connection
---------------------	-------------------------------

* Functions as PC controller through Xinput.
This product does not support DirectInput.

Important

Before using this product with your PlayStation®5 console or PlayStation®4 console, please read the included instructions carefully.
Please check that your PlayStation®5 console or PlayStation®4 console is updated to the latest system software.

Layout

Steering unit

[Front View]

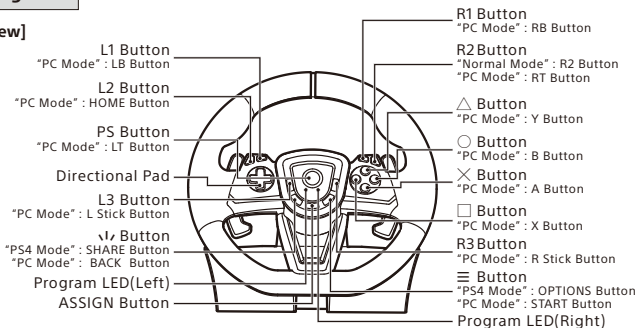

[Back View]

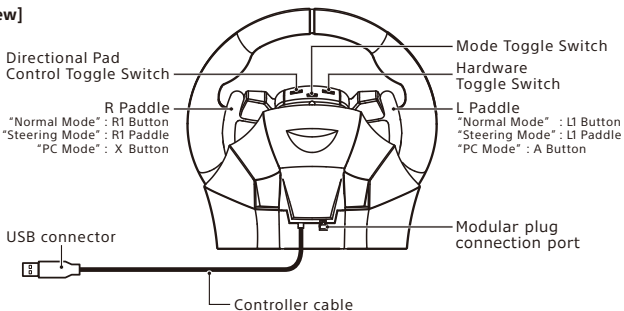

Foot pedals

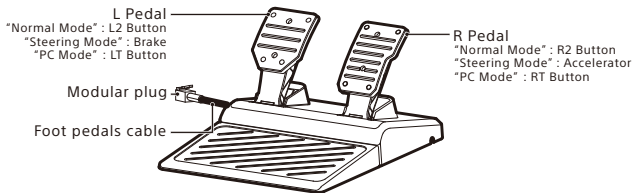

Product Setup

- 1) Tighten the clamp into the steering unit base with the screw.
- 2) Use the clamp to secure the steering unit to a flat, hard surface (i.e. table).

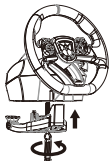

- * Do not attach to furniture made from glass or other fragile materials.
- * Carefully detach from furniture to prevent damage to furniture or product.

- 3) Assemble the foot pedal as shown in the image below.



How to Connect

- 1) Connect the foot pedal's modular plug to the steering unit's modular plug connection port.



* This product can be used without the foot pedals.

- 2) Set the Mode Toggle Switch to the appropriate setting, and then connect the USB cable.

- * Do not press on any buttons when connecting the USB cable.
- * Check the connector direction before inserting.

[PS5™ Steering Mode] (For PlayStation®5 consoles) * Functions only for "Steering Mode" compatible titles. Please visit website for more information. (URL)

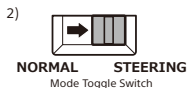
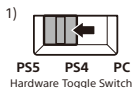

[PS5 Normal Mode]

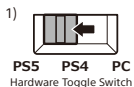

[PS4™ Steering Mode]

(For PlayStation®4 consoles) * Functions only for "Steering Mode" compatible titles.
Please visit website for more information.
(URL)

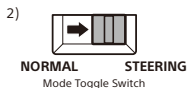
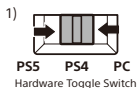

[PS4 Normal Mode]

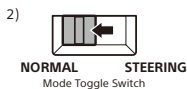
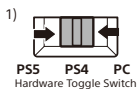

[PC Mode]

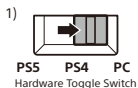

Download App

『HORI Device Manager』

Please download and install the "HORI Device Manager" from this product's website using your PC.

URL : <https://hori.jp/manual/p5/spf-004/>

The following features can be adjusted in the app:

- Quick Handling Mode
- Dead Zone Adjustment
- Sensitivity Adjustment
- Assign Mode
- Profile
- D-Pad/Analog Stick Toggle Switch

Quick Handling Mode

Experience quicker handling by switching the max steering output from 270 degrees to 180 degrees.

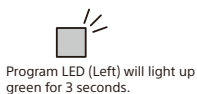
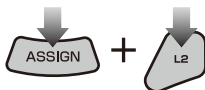
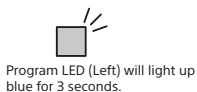
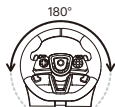

Directional Pad Control Toggle Switch

Directional pad controls can be toggled to directional pad, left stick or right stick controls.

This product's directional pad toggle function is not guaranteed to work with all software.

* Please refer to the software's instruction manual. This product does not work with Analog mode.



Adjustable Dead Zone

The dead zone play of centered wheel is adjustable to seven levels.

Program LED (Left) color will change to indicate the dead zone value.

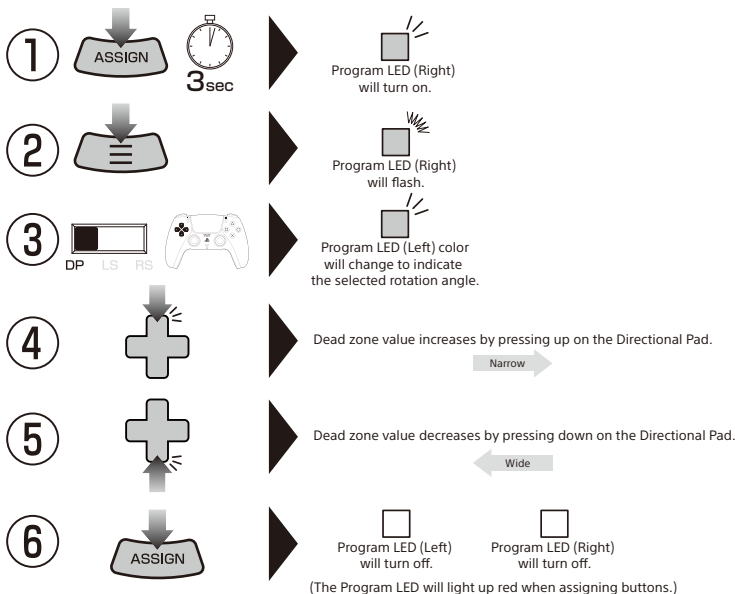

* If you do not perform step ② after ①, the Program LED will turn off after four seconds and Dead Zone Adjustment mode will automatically end.

* During steps ②~③, only the steering unit and foot pedal input are enabled.

* Button input from the controller to the PlayStation®5 console or PlayStation®4 console will be disabled.

* Controller settings are saved even if the USB is disconnected.



	1	2	3	4	5	6	7
LED color	Green	Yellow	Red	Purple	Blue	Light Blue	White

Adjustable Sensitivity

Steering wheel sensitivity is adjustable to seven levels.
The Program LED (Left) color will change to indicate the sensitivity value.

Steering unit

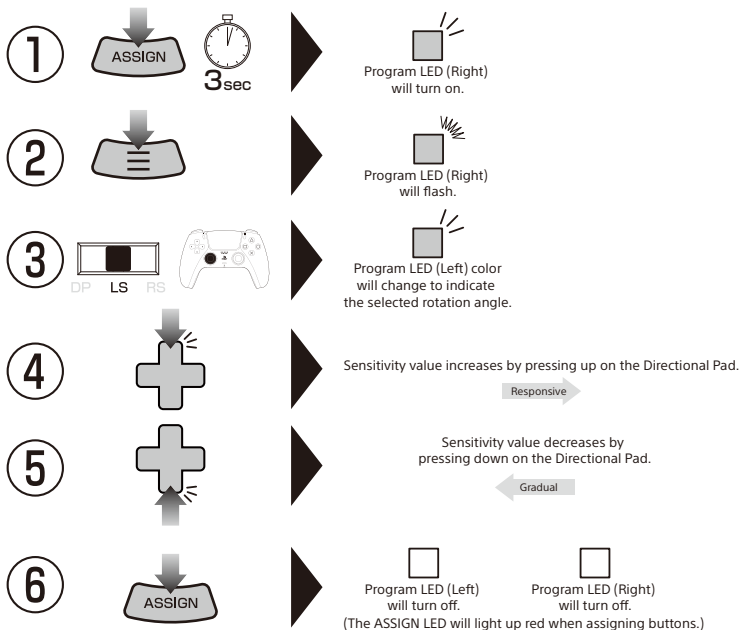

* If you do not perform step ② after ①, the Program LED will turn off after four seconds and Sensitivity Adjustment mode will automatically end.

* During steps ②~④, only the steering unit and foot pedal input are enabled.

Button input from the controller to the PlayStation®5 console or PlayStation®4 console will be disabled.

* Controller settings are saved even if the USB is disconnected.

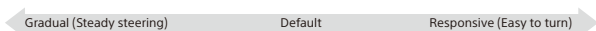

	1	2	3	4	5	6	7
LED color	Green	Yellow	Red	Purple	Blue	Light Blue	White

Foot pedals

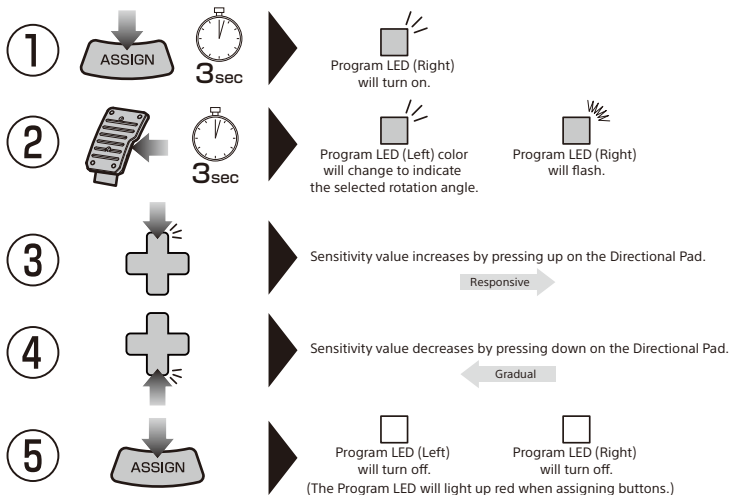

* If you do not perform step ② after ①, the Program LED will turn off after four seconds and Sensitivity Adjustment mode will automatically end.

* During steps ②~③, only the steering unit and foot pedal input are enabled.

Button input from the controller to the PlayStation®5 console or PlayStation®4 console will be disabled.

* Controller settings are saved even if the USB is disconnected.

	Gradual		Default			Responsive	
LED color	1 Green	2 Yellow	3 Red	4 Purple	5 Blue	6 Light Blue	7 White

Quick Handling Mode · Dead Zone Adjustment · Linearity Adjustment Reset All

To simultaneously reset all of the following : Quick Handling Mode · Dead Zone Adjustment · Linearity Adjustment.

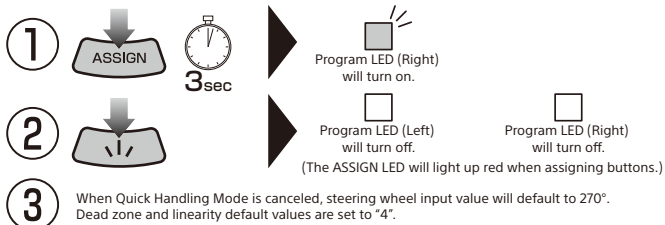

* If you do not perform step ② after ①, the Program LED will turn off after four seconds and assignment mode will automatically end.

Assign Mode

You can remap the function of buttons using this feature.

Programmable Buttons

L1 Button / R1 Button / L2 Button / R2 Button /
L3 Button / R3 Button / L paddle / R paddle
L pedal / R pedal

Assignable Functions

○ Button / × Button / △ Button / □ Button / L1 Button / L2 Button / L3 Button / R1 Button
/ R2 Button / R3 Button / L paddle / R paddle / L pedal / R pedal
Left stick (Right / Down / Left / Up) / Right stick (Right / Down / Left / Up) / Directional Pad

How to adjust

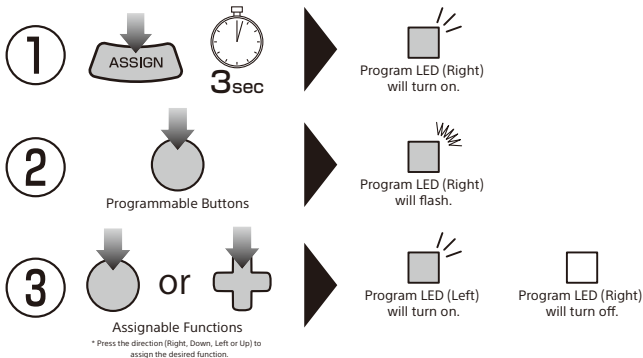

* For step 3, to assign a specific direction input of the Left Analog Stick to a button, set the Directional Pad toggle switch (DP/LS/RS) to [LS] and press the D-Pad in the direction you want to assign. For Right Analog Stick, set to [RS].

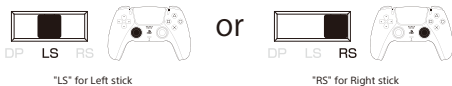

- * After 4 seconds of inactivity between steps, Program LED (Right) will turn off and program mode will stop.
- * During steps 2, button input from the controller to the PlayStation®4 console will be disabled.
- * When the Program LED (Left) turns on, it indicates that a button is remapped and will not turn off until button function is reset to default.
- * If you want to disable button function, press and hold for 3 seconds the same button you pressed in step 2 at the time of step 3.
- * If you pressed multiple buttons during step 3, the last button you pressed will be assigned.
- * Controller settings are stored even if the USB is disconnected.

How to Reset Buttons Individually

For step 3, press the same button from step 2 to individually reset buttons to default.

How to Reset All Buttons

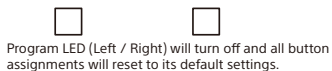

Main Features

Steering unit

External Dimensions : 280×243×268mm

Steering Diameter : 280mm

Angle of Rotation : 270°

Weight : 1.4kg

Cable Length : 3.0m

Foot pedals

External Dimensions : 225×300×148mm

Weight : 0.9kg

Cable Length : 1.5m

Simplified Declaration of Conformity

Hereby, HORI declares that this product is in compliance with Directive 2014/53/EU.

The full text of the EU declaration of conformity is available at the following internet address:

<https://hori.co.uk/consumer-information/>

For UK: Hereby, HORI declares that this product is in compliance with the relevant statutory requirements.

The full text of the declaration of conformity is available at the following internet address:

<https://hori.co.uk/consumer-information/>

THE FCC WANTS YOU TO KNOW

This device complies with part 15 of the FCC Rules. Operation is subject to the following two conditions: (1) This device may not cause harmful interference, and (2) this device must accept any interference received, including interference that may cause undesired operation.

NOTE: This equipment has been tested and found to comply with the limits for a Class B digital device, pursuant to part 15 of the FCC Rules. These limits are designed to provide reasonable protection against harmful interference in a residential installation. This equipment generates, uses and can radiate radio frequency energy and, if not installed and used in accordance with the instructions, may cause harmful interference to radio communications. However, there is no guarantee that interference will not occur in a particular installation. If this equipment does cause harmful interference to radio or television reception, which can be determined by turning the equipment off and on, the user is encouraged to try to correct the interference by one or more of the following measures:

- Reorient or relocate the receiving antenna.
- Increase the separation between the equipment and receiver.
- Connect the equipment into an outlet on a circuit different from that to which the receiver is connected.
- Consult the dealer or an experienced radio/TV technician for help.

The normal function of the product may be disturbed by strong electro-magnetic interference. If so, simply reset the product to resume normal operation by following the instruction manual (How to connect). In case the function does not resume, please relocate to an area which does not have electro-magnetic interference to use the product.

The wires are not to be inserted into socket-outlets.

The packaging must be retained since it contains important information.

PRODUCT DISPOSAL INFORMATION

Where you see this symbol on any of our electrical products or packaging, it indicates that the relevant electrical product or battery should not be disposed of as general household waste in Europe. To ensure the correct waste treatment of the product and battery, please dispose of them in accordance with any applicable local laws or requirements for disposal of electrical equipment or batteries. In so doing, you will help to conserve natural resources and improve standards of environmental protection in treatment and disposal of electrical waste. Applicable to EU countries and Turkey only.



EU and Turkey only

US

Warranty

HORI warrants to the original purchaser that the product purchased new in its original packaging shall be free of any defects in material and workmanship for a period of 1 year from the original date of purchase. If the warranty claim cannot be processed through the original retailer please contact HORI customer support directly at info@horiusa.com. Please visit <http://stores.horiusa.com/policies/> for warranty details.

EU

Warranty

For all warranty claims made within the first 30 days after purchase, please check with the retailer where the original purchase was made for details. If the warranty claim cannot be processed through the original retailer or for any other inquiries pertaining to our products, please contact HORI customer support directly at info@horiuk.com.

“PS”, “PlayStation”, “PS5”, “PS4” and “DualSense” are registered trademarks or trademarks of Sony Interactive Entertainment Inc. All rights reserved.

All other trademarks are the property of their respective owners.

Manufactured and distributed under license from Sony Interactive Entertainment.