

Product Specifications

Model:	Pure-15S Passive 15" Subwoofer
System:	Bass-reflex Subwoofer
Power RMS:	600 W
Power peak:	1200 W
Speaker low:	15", 4" Voice coil
Frequency response (-3 dB):	38-160 Hz
Frequency response (-10 dB):	35-200 Hz
Speaker sensitivity:	103 dB / W / m
Max. SPL @ 1 m:	131 dB
Speaker impedance:	8 Ω
Crossover frequency:	125 Hz, 24 dB/Oct BW
Recommended HPF:	36 Hz, BW-24
Audio connector:	Speakon NL4 IN/OUT/MID-HIGH OUT
Housing:	18-mm Birch Plywood
Color:	Black, scratch resistant
Mounting:	35-mm/M20 pole mount
Dimensions:	552 x 454 x 570 mm (LxWxH)
Weight:	31,76 kg

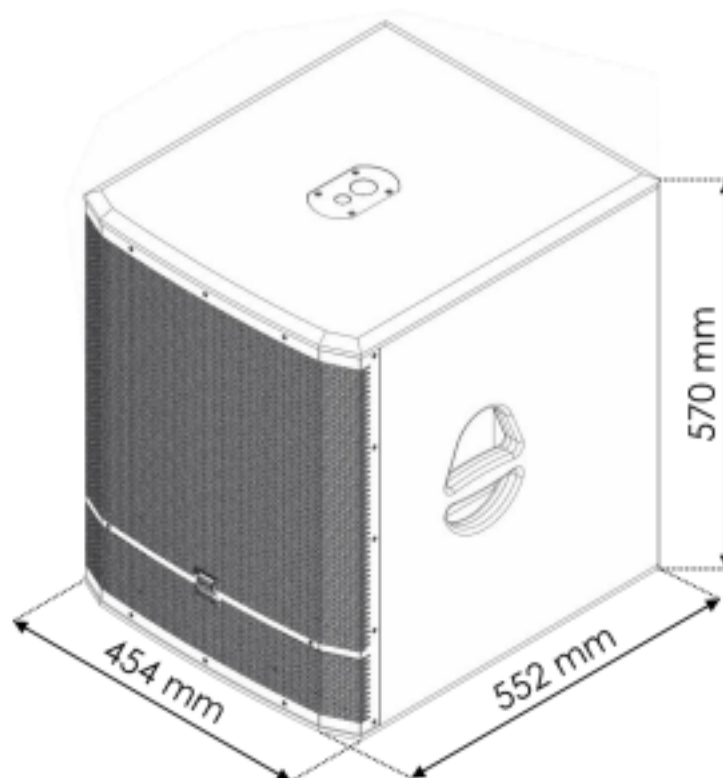

Design and product specifications are subject to change without prior notice.



Website: www.Dap-audio.info
Email: service@highlite.com