

LC-POWER™

LC-M34-UWQHD-100-C-V3

CURVED GAMING MONITOR



USER MANUAL

INHALT

1. Sicherheitsmaßnahmen
2. Wartung
3. Lieferumfang
4. Produktübersicht
5. Ständer montieren
6. Wandmontage
7. Anschlussmöglichkeiten
8. Grundbedienung
9. Indikatorleuchte
10. OSD
11. ECO-Modi und Gameplus-Umschaltung
12. Technische Daten

1. Sicherheitsmaßnahmen

Benutzen Sie den Monitor nicht in feuchter Umgebung, lassen Sie das Gerät nicht mit Regen und anderen Flüssigkeiten in Kontakt kommen. Öffnen Sie nicht das Monitorgehäuse! Es besteht akute Stromschlaggefahr durch Hochspannung im Inneren!

Betrieb:

- Halten Sie den Monitor von direkter Sonneneinstrahlung und anderen Wärmequellen (z. B. Heizungen) fern.
- Halten Sie jegliche Flüssigkeiten vom Monitor fern.
- Achten Sie darauf, dass nichts in die Belüftungsöffnungen fallen kann.
- Blockieren Sie die Belüftungsöffnungen nicht; andernfalls kann es zu Überhitzung kommen.
- Schlagen Sie nicht gegen den Monitor, lassen Sie das Gerät nicht fallen.

2. Wartung

ACHTUNG: Ziehen Sie das Netzkabel aus der Steckdose, bevor Sie den Monitor reinigen.

- Zum Reinigen des Bildschirms benutzen Sie ein weiches Tuch, das Sie leicht (!) mit destilliertem Wasser angefeuchtet haben.
- Verwenden Sie am besten spezielle Reinigungstücher für Bildschirme.
- Benutzen Sie keinesfalls Benzin, Verdünnung, sehr saure oder alkalische Mittel, Scheuermittel oder Druckluft!
- Ungeeignete Reinigungsmittel können den Monitor beschädigen und unschöne Schlieren auf dem Bildschirm und dem Gehäuse hinterlassen.
- Ziehen Sie den Netzstecker, wenn Sie den Monitor längere Zeit nicht benutzen.
- Halten Sie den Monitor von sämtlichen Flüssigkeiten, Staub und Feuchtigkeit fern.
- Falls der Monitor mit Flüssigkeiten in Berührung gerät, wischen Sie ihn sofort mit einem Tuch trocken.
- Falls Flüssigkeiten in die Belüftungsöffnungen eindringen, ziehen Sie sofort den Netzstecker, benutzen den Monitor nicht mehr. Wenden Sie sich an den professionellen Kundendienst.

Rechtliche Hinweise:



HDMI, das HDMI-Logo und „High-Definition Multimedia Interface“ sind Marken oder eingetragene Marken der HDMI Licensing Administrator LLC in den USA und anderen Ländern.

3. Lieferumfang

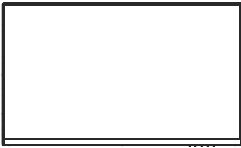

Monitor



Ständerschaft



Ständerbasis



Kabelclip

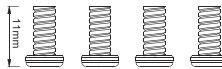

Schrauben

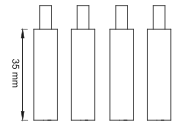

Schrauben
(zur Wandmontage)

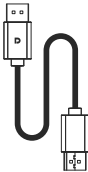

DP-Kabel

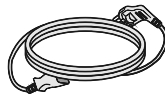

Netzkabel Schraubendreher

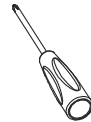

Schraubendreher



Bedienungsanleitung



Eventuell sind zusätzliche Schrauben als Ersatz beigelegt.

4. Produktübersicht

4.1 Tasten am Monitor

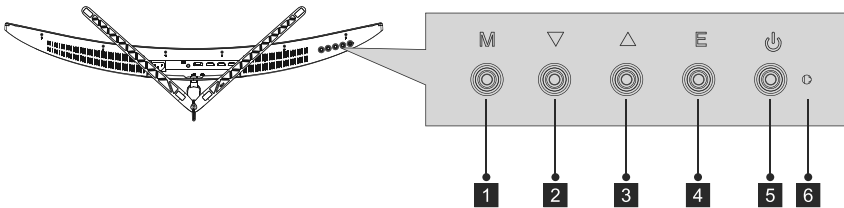

- 1 **Menütaste (M):** Zum Einblenden des OSD-Menüs und zum Aufrufen von Untermenüs.
- 2 **▼ Abwärtstaste:** Zum Abwärtsbewegen in den Menüs.
- 3 **▲ Aufwärtstaste:** Zum Aufwärtsbewegen in den Menüs.
- 4 **Verlassen-Taste (E):** Zum Verlassen drücken.
- 5 **Ein-/Austaste:** Schaltet den Monitor ein und aus.
- 6 **LED:** Zeigt den Betriebsstatus durch unterschiedliche Farben an.

4.2 Monitoranschlüsse

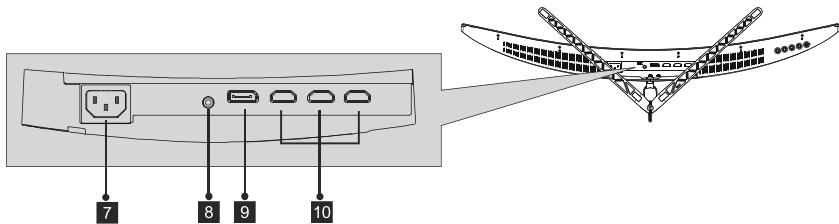

- 7 **Netzanschluss:** Hier schließen Sie das Netzkabel zur Stromversorgung des Monitors an.
- 8 **Audioausgang:** Hier können Sie Kopfhörer anschließen, über die Sie den zum Monitor übertragenen Ton abhören können.
- 9 **DP-Anschluss:** Schließen Sie einen Stecker des DP-Kabels an den DP-Ausgang des Computers, den anderen Stecker an den DP-Port des Monitors an.
- 10 **HDMI-Anschlüsse:** Schließen Sie einen Stecker des HDMI-Kabels an den HDMI-Ausgang des Computers, den anderen Stecker an den HDMI-Port des Monitors an.

5. Ständer montieren



Belassen Sie die Schaumpolsterung unter dem Monitor, bevor Sie den Ständer anbringen.

1. Öffnen Sie die Verpackung, nehmen Sie den Monitor mitsamt Schaumstoff heraus, stellen Sie das Gerät sanft auf einem Tisch ab. Nehmen Sie dann Schaft, Kabelclip und Basis aus der Verpackung. Fixieren Sie die Basis anschließend mit einer Schraube am Schaft.

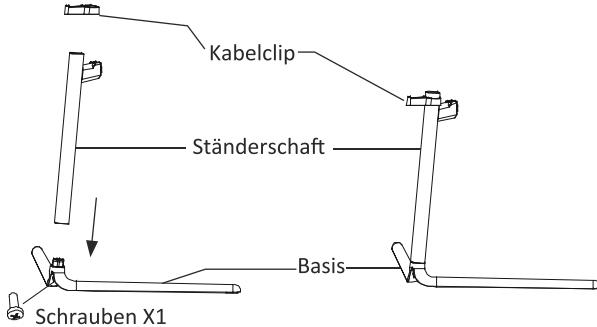

2. Nehmen Sie zuerst die Schaumstoffpolsterung an der Unterseite des Monitors, dann den Konverter an der Rückseite des Monitors ab. Fixieren Sie den Konverter mit zwei Schrauben am Schaft.

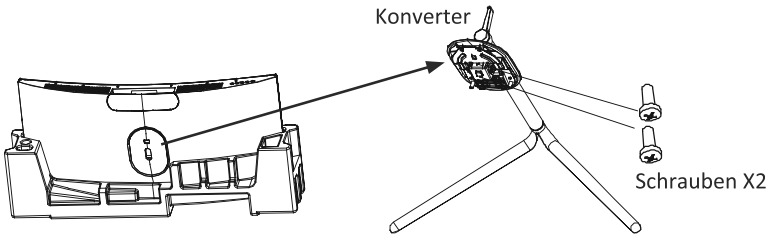

3. Bringen Sie den Konverter mitsamt Schaft und Basis an der Rückwand des Monitors an. Entfernen Sie dann den Schaumstoff vom Monitor, stellen Sie den Monitor auf einen Tisch. Zum Abnehmen des Monitors drücken Sie einfach die Freigabetaste.

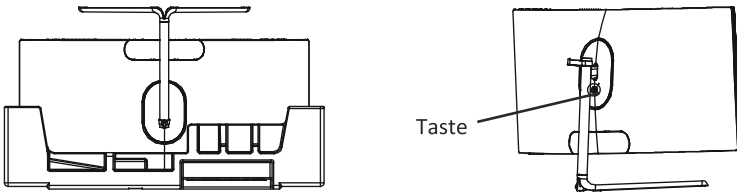

Legen Sie den Monitor auf eine flache Unterlage, bevor Sie den Ständer abnehmen.

6. Wandmontage



Die mitgelieferten Schrauben eignen sich ausschließlich zum Fixieren des Monitors an einer VESA-Halterung mit 75*75mm Schraubenabstand. VESA-Halterungen und Montagezubehör erhalten Sie separat im Fachhandel.

1. Öffnen Sie die Verpackung, nehmen Sie das Gerät mitsamt Schaumstoff heraus, stellen Sie das Gerät sanft auf einem Tisch ab. Nehmen Sie die Zusatzeile und die Schaumstoffpolsterung an der Rückseite des Monitors ab. Drücken Sie die Freigabetaste zum Abnehmen der Ständerplatte. Falls der Ständer bereits am Monitor angebracht ist, nehmen Sie den Ständer ab.

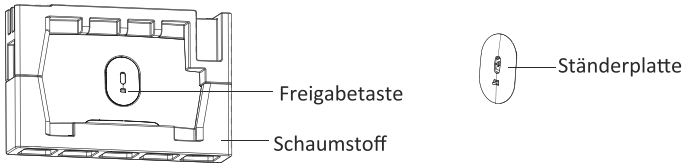

2. Lösen Sie die 4 Originalschrauben (①) an der Öffnung an der Rückwand des Monitors.
3. Bringen Sie den Monitor an der Wand oder Halterung an, halten Sie sich dabei an die mit der Halterung oder anderem Montagezubehör gelieferten Anleitung. Vergessen Sie nicht, die 4 mitgelieferten Schrauben zur Montage des Monitors zu verwenden. Die Abbildung (②) zeigt die richtige Schraubenplatzierung.

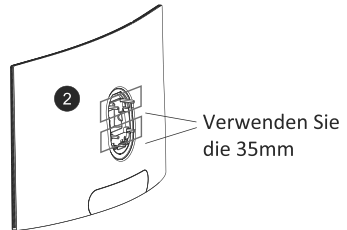
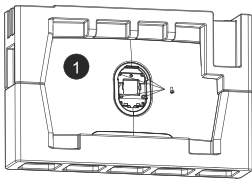

Werfen Sie die Originalschrauben nicht weg. Diese können sich künftig als nützlich erweisen.

4. Bringen Sie den Monitor an der Wand oder Halterung an, halten Sie sich dabei an die mit der Halterung oder anderem Montagezubehör gelieferten Anleitung.

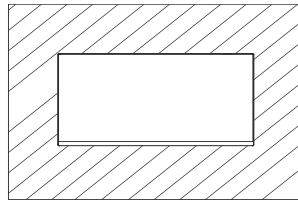
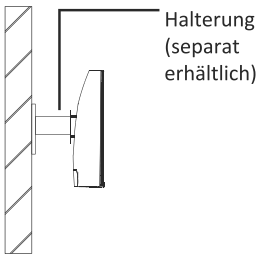

7. Anschlussmöglichkeiten

7.1 Netzkabel anschließen

Schließen Sie das mitgelieferte Netzkabel an den Netzanschluss an, stecken Sie dann den Netzstecker in die Steckdose.

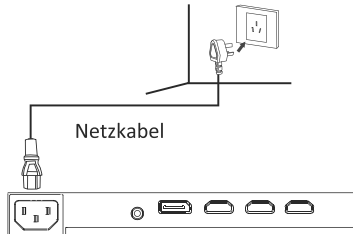

7.2 Kopfhörer anschließen

Über den Kopfhöreranschluss können Sie den zum Monitor übertragenen Ton ausgeben. Wenn Audiogeräte an den Monitor und gleichzeitig andere Audiogeräte an dem Computer verbunden sind, werden letztere Audiogeräte stummgeschaltet. Kopfhörer und andere Audiogeräte sind separat erhältlich.

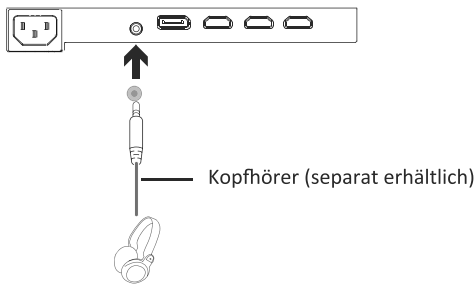

7.3 HDMI-Verbindung

Wenn Sie HDMI-Signale zum Monitor übertragen möchten, verbinden Sie Computer und Monitor über ein HDMI-Kabel.

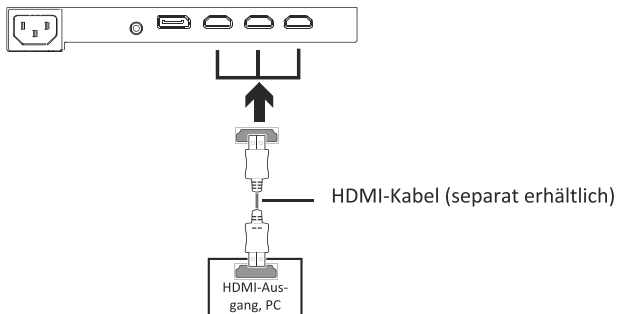

7.4 DP-Verbindung

Verbinden Sie den Monitor über das DP-Kabel mit dem Computer, wenn Sie DisplayPort zur Verbindung nutzen möchten.

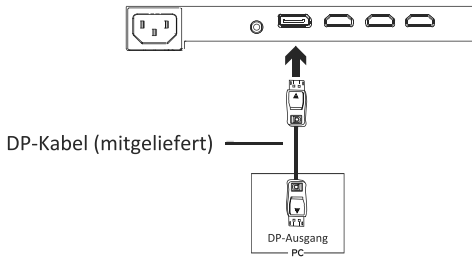

8. Grundbedienung

1. Schließen Sie das DP-Kabel an den DP-Ausgang der PC-Grafikkarte an. Sie können auch ein HDMI-Kabel verwenden. HDMI-Kabel sind separat erhältlich.
2. Schließen Sie den freien Stecker des Kabels an den passenden Anschluss am Monitor an.

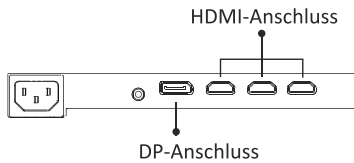

3. Schließen Sie das Netzkabel an den Monitor an, stecken Sie dann den Netzstecker in die Steckdose. Wir empfehlen, das Gerät über eine Steckdose mit Überspannungsschutz anzuschließen.
4. Zum Einschalten drücken Sie die Netztaaste am Monitor.

9. Indikatorleuchte

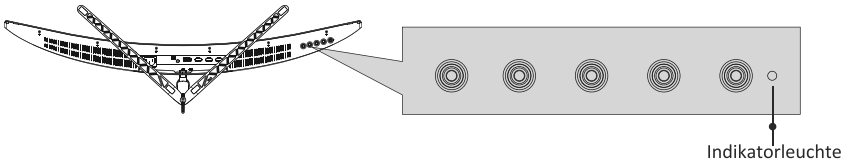

Blaues Leuchten bedeutet, dass der Monitor mit Strom versorgt wird und normal arbeitet. Blaues Blinken zeigt an, dass keine Videoquelle, kein Horizontal- oder Vertikalsignal erkannt wird oder die Spannung zu gering ist. Bitte sorgen Sie dafür, dass Ihr Computer eingeschaltet ist und sämtliche Kabel richtig und komplett eingesteckt sind.

10. OSD

Mit dem Bildschirmmenü (OSD) können Sie die Monitoreinstellungen anpassen. Das OSD-Menü erscheint, wenn Sie bei eingeschaltetem Monitor die **M**-Taste drücken.



Wenn Sie den Monitor zum ersten Mal benutzen, nimmt das Gerät anhand der Konfiguration Ihres Computers automatisch optimale Einstellungen vor.

1. Drücken Sie eine der Tasten (**M**, **▼**, **▲**, **E**, **⏻**) zum Einblenden des Navigationsfensters.

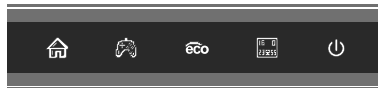

2. Drücken Sie **M**  zum Einblenden des OSD-Menüs.

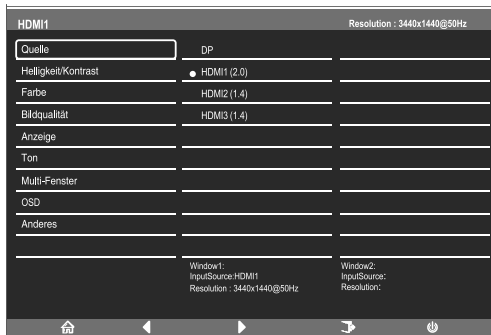

3. Mit den Tasten **▼** / **▲** blättern Sie die Funktionen durch.
 - Markieren Sie die gewünschte Funktion, danach wechseln Sie mit der **M**-Taste in das jeweilige Untermenü.
 - Mit den Tasten **▼** / **▲** wählen Sie die gewünschte Funktion in den Untermenüs, zur Auswahl drücken Sie die **M**-Taste.
 - Markieren Sie die gewünschte Option mit den Tasten **▼** / **▲**. Anschließend drücken Sie die **M**-Taste zum Bestätigen der Einstellungen und zum Verlassen des aktuellen Menüs.
4. Mit der **E**-Taste verlassen Sie das Einstellungs Menü.

10.1 OSD-Menüfunktionen

Quelle	DP	N/A
	HDMI1	N/A
	HDMI2	N/A
	HDMI3	N/A
Helligkeit/ Kontrast	Helligkeit	0-100
	Blacklevel	0-100
	Kontrast	0-100
	Dyn. Kontrast	AN/AUS
Farbe	Gamma	1.8/2.0/2.2/2.4/2.6
	Bildmodus	Standard/Photo/Film/Spiel/Ego-Shooter/Echtzeitstr.
	Farbtemperatur	Warm/Kühl/ANWENDER
	Niedrig. Blau	0-100
	Farbton	0-100
	Sättigung	0-100
Bildqualität	Schärfe	0-100
	Reaktionszeit	AUS/Hoch/Mittel/Niedrig
	Rauschminderung	AUS/Hoch/Mittel/Niedrig
	Dyn. Leuchtkontrolle	AN/AUS
Anzeige	Bildformat	Breitbild/4:3/1:1/Automatisch
	LedMode	Normal/AUS/Flackern
Ton	Stumm	AN/AUS
	Lautstärke	0-100
	Audioquelle	AutoSource
Multi-Fenster	Multi-Fenster	AUS/PIP-Modus/PBP 2-Fenster
	Sub 2-Eingang	DP1//HDMI1/HDMI2/HDMI3
	PIP-Größe	Klein/Mittel/Gro
	PIP Position	Oben rechts/Oben links/Unten rechts/Unten links
	Tausch	N/A
OSD	Sprache	English/简体中文/한국어/РУССКИЙ/Español/日本語/Français/Deutsch/Italian
	OSD H-Position	0-100
	OSD V-Position	0-100
	OSD-Transparenz	0-100
	OSD-Abschaltung	5-100
	OSD Rotation	Normal/90/180/270
Other	Adaptive-Sync	AN/AUS
	Reset	N/A

11. ECO-Modi und Gameplus-Umschaltung

1. Drücken Sie eine der Tasten (**M**, **▼**, **▲**, **E**, **🔌**) zum Einblenden des Navigationsfensters.



2. Drücken Sie die Taste **▼** zum Umschalten zu den Gameplus-Modi. Wählen Sie das zu Ihrem Spiel passende Symbol. Die Symbole sollen in erster Linie das Zielen in Spielen optimieren, lassen sich aber auch für andere Zwecke benutzen.



3. Mit der Taste **▼** zum Umschalten zu den ECO-Modi. Zu diesen Modi zählen Standard, Text, Film, Spiel, FPS und RTS – durch Auswahl des passenden Modus können Sie die Einstellungen optimal an den Zweck anpassen. Der Standardmodus ist die beste Wahl für die meisten Zwecke.

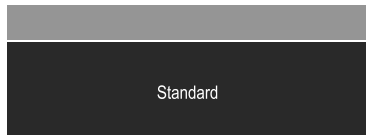

12. Technische Daten

Modell	LC-M34-UWQHD-100-C-V3
Bildschirmgröße	34 Zoll
Bildformat	21:9
Beleuchtung	E-LED
Helligkeit	300 cd/m ² (typ.)
Panel	VA
Auflösung	DP1.2: 3440 * 1440 bei 100 Hz HDMI 2.0: 3440 * 1440 bei 100 Hz HDMI 1.4: 3440 * 1440 bei 60 Hz
Bildwiederholfrequenz	100Hz
Reaktionszeit	OD 6 ms
Betrachtungswinkel	178°(H) / 178°(V)
Kontrastverhältnis	3000:1
VESA-Montage	75 × 75
Farben	16,7 Millionen
Adaptive-sync	Ja
Signaleingang	DP 1.2*1, HDMI 1.4*2, HDMI 2.0*1
Audio	
Lautsprecher	Nein
Audioausgang	Ja
Zubehör	
Ein/Aus	100 – 240 Wechselspannung, 50/60 Hz, 2,0 A
DisplayPort-Kabel	Ja
Weitere Funktionen	
Blaureduktion	Ja
Flackerfrei	Ja
Abmessungen	
Abmessungen (mit Ständer)	808,65*454,19*225,58mm
Abmessungen (ohne Ständer)	808,65*363,33*123,12mm
Nettogewicht	7,35kg
Bruttogewicht	9,5kg

TABLE OF CONTENTS

1. Safety precautions
2. Maintenance
3. Box contents
4. Product overview
5. Stand installation
6. Wall mounting
7. Connectivity options
8. Basic operation
9. Indicator light
10. OSD
11. ECO Modes and Gameplus Switching
12. Technical specifications

1. SAFETY PRECAUTIONS

Do not expose the monitor to a humid environment, rain or other liquids. Do not open the monitor housing to avoid any shock due to electrical or mechanical hazards.

Operation:

- Keep the monitor out of direct sunlight or other heat sources like stoves.
- Keep the monitor away from any liquid.
- Remove any object that could fall into the ventilation holes.
- Do not block the ventilation holes to avoid overheating.
- Do not knock or drop the monitor.

2. MAINTENANCE

CAUTION: Unplug the power cable from the outlet before cleaning the monitor.

- To clean your screen, slightly moisten a soft, clean cloth with water.
- Please use a special screen-cleaning tissue if possible.
- Do not use benzene, thinner, ammonia, abrasive cleaners or compressed air.
- Inappropriate cleaning solutions may damage the monitor or leave a milky film on screen or housing.
- Unplug the monitor if you are not going to use it for a longer time period.
- Do not expose the monitor to dust, liquids or a humid environment.
- In case the monitor gets in touch with any liquid, wipe it down immediately using a dry cloth.
- In case any liquid gets spilled into the ventilation holes, do not use the monitor anymore. Please contact a professional service technician.

Legal notice:



The terms HDMI and HDMI High Definition Multimedia Interface, and the HDMI logo are trademarks or registered trademarks of HDMI Licensing Administrator, Inc. in the USA and other countries.

3. Box Contents

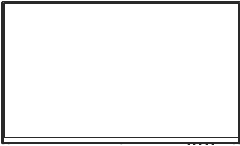

Monitor



Stand Stem



Stand Base



Cable Clip

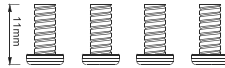

Screws

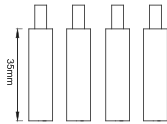

Screws
(For Wall Mounting)

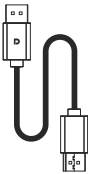

DP Cable



Power Cable

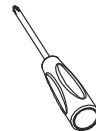

Screwdriver



User Manual



Extra screws may be included as backup.

4. Product Overview

4.1 – Monitor Buttons

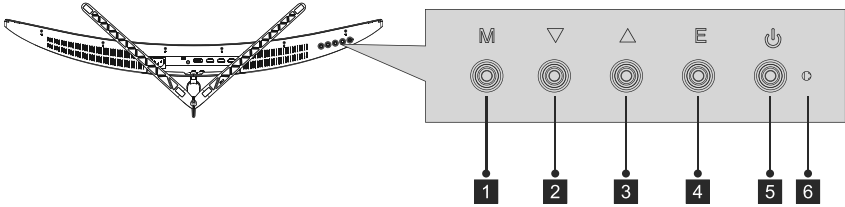

- 1 **M Menu Button:** Press to display the OSD menu or enter sub-menus.
- 2 **▼ Down Button:** Press to move down in the menus.
- 3 **▲ Up Button:** Press to move up in the menus.
- 4 **E Exit Button:** Press to exit.
- 5 **⏻ Power Button:** Press to turn the monitor on/off.
- 6 **LED Indicator:** Changes colors to indicate status.

4.2 – Monitor Ports

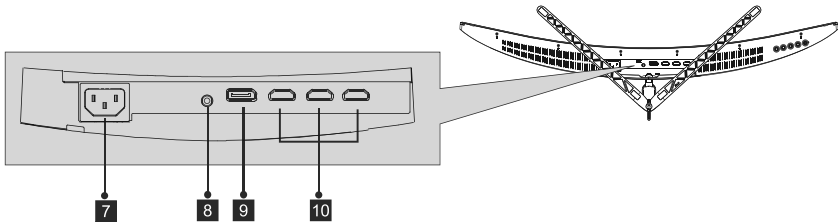

- 7 **Power Connector:** Insert the power cable to supply power to the monitor.
- 8 **Audio Output:** Insert one end of the Audio cable into the computer's Audio output to receive the Audio signals from your monitor.
- 9 **DP Connector :** Insert one end of the DP cable into the computer's DP output and connect the other end to the monitor's DP port.
- 10 **HDMI Connectors :** Insert one end of the HDMI cable into the computer's HDMI output and connect the other end to the monitor's HDMI port.

5. Stand Installation

 Keep the foam underneath the monitor before attaching the stand.

1. Open the package, take out the product with foam still attached, and gently place it on a desktop or table. Then, take out the stem, cable clip, and base, use the screwdriver and one screw to fasten base to the stem.

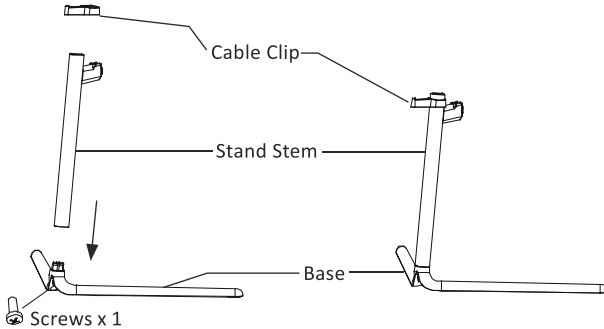

2. Remove the foam covering the bottom of the monitor, then remove the converter on the back of the monitor. Then, use two screws to fasten the converter onto the stem.

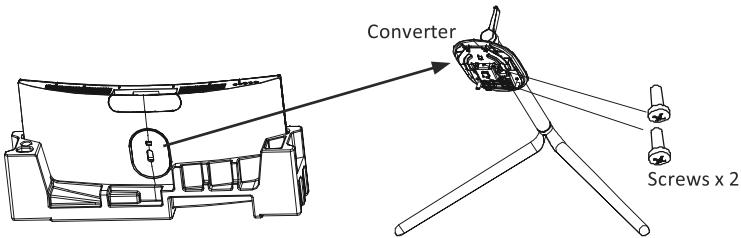

3. Attach the converter with the stem and base onto the back of the monitor. Then remove the foam on the monitor and set it up on the desktop. Press the button to remove the monitor from the bracket and unmount it.

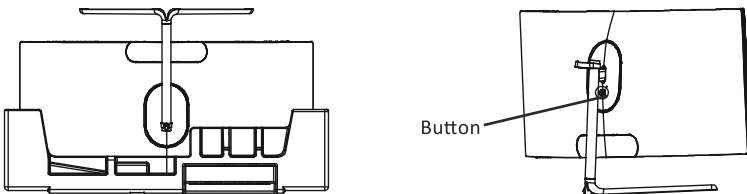

 Make sure the monitor is laid on a flat surface before removing the stand.

6. Wall Mounting

 This monitor only includes screws which may be used when attaching the monitor to a VESA 75*75mm type mount. No VESA mount or mounting accessory is included.

1. Open the package, take out the product with foam still attached, and gently place it on a desktop or table. Remove the extra parts and the foam covering the back of the monitor. Press the release button to remove the stand plate. If the monitor was already attached to the stand, remove the stand.

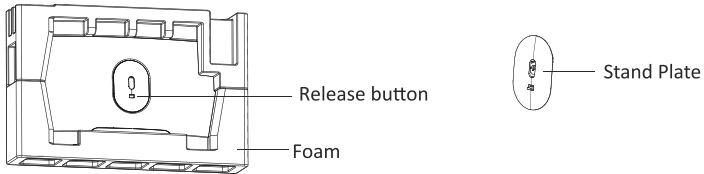

2. Remove the original screws x4 (1) from the opening in the back of the monitor.
3. Follow the directions received with your mount, stand, or accessory and install the monitor on the wall or fixture as desired. Remember to use the included 4 screws when mounting the monitor. Refer to the image (2) for correct screw placement.

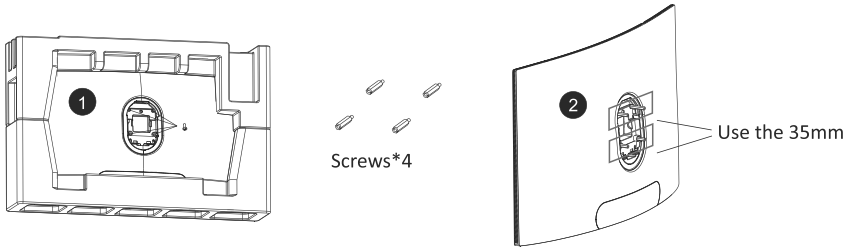

 Do not discard the original screws. These may be needed for future use.

4. Follow the directions received with your mount, stand, or accessory and install the monitor on the wall or fixture as desired.

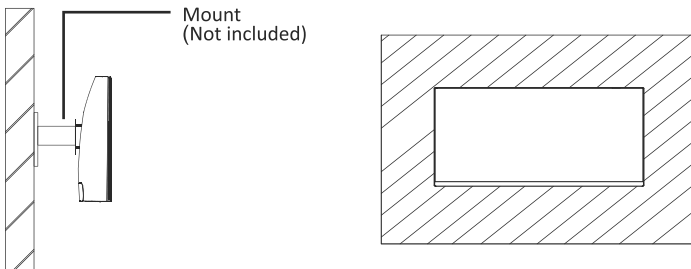

7. Connectivity Options

7.1 – Connecting the Power Cable

Connect the included power cable to the power connector, and then plug the other end into an wall outlet.

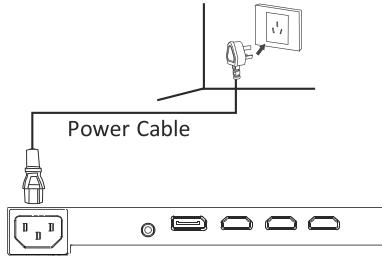

7.2 –Connecting Your Earphones

Plug in your earphones to receive audio signals from your monitor. If your earphones are connected to the monitor and audio devices are connected to your computer at the same time, the audio devices will not produce sound. Earphones and other audio devices are not included.

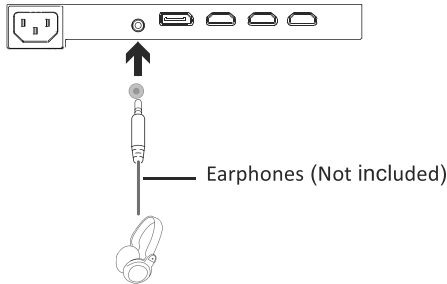

7.3 – HDMI Connectivity

In order for the monitor to receive HDMI signals from the computer, use the HDMI cable to connect the monitor to the computer.

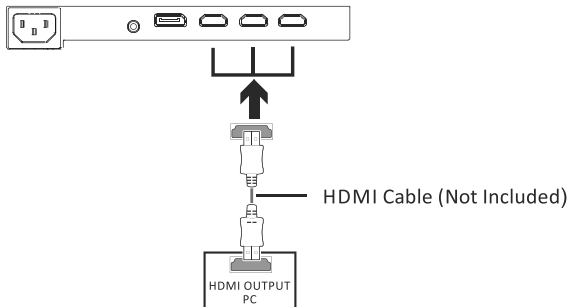

7.4 – DP Connectivity

In order for the monitor to receive DP signals from the computer, use the DP cable to connect the monitor to the computer.

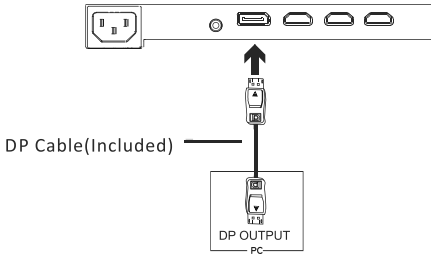

8. Basic Operation

1. Insert one end of the DP cable into your PC's graphics card. A HDMI cable may also be used. A HDMI cables is not included.
2. Connect the other end of the cable to the corresponding connector on your monitor.

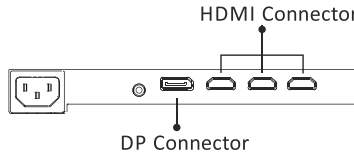

3. Connect the power cable to your monitor then connect the other end to your power source. It is recommended that you use a surge protector with adequate voltage if a wall outlet cannot be reached directly.
4. Press the power button to turn on the monitor.

9. Indicator Light

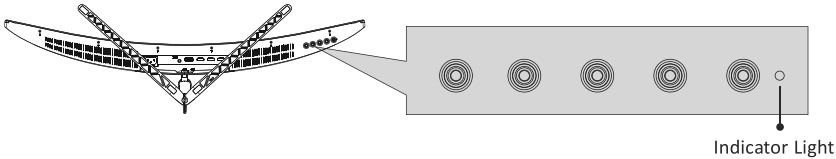

Solid blue light indicates power is on and the monitor is operating normally. Flashing blue light indicates no video source, no horizontal or vertical signal has been detected or voltage is low. Please ensure your computer is on and all video cables are fully inserted and/or connected.

10. OSD

The On-Screen Display (OSD) Menu may be used to adjust your monitor's settings and appears on screen after turning on the monitor and pressing the **M** button.

 When using the monitor for the first time, settings will automatically adjust to optimal settings according to your computer's configuration and parts etc.

1. Press any one of the buttons (**M**, **▼**, **▲**, **E**, ) to activate the navigation window.

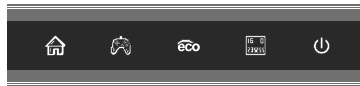

2. Press **M**  to enter the OSD menu.

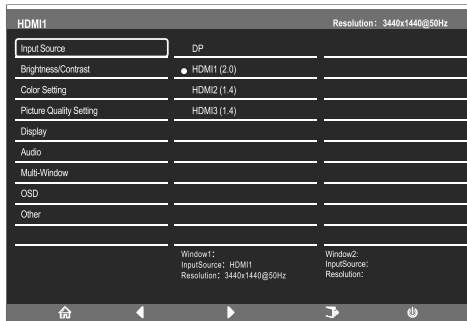

3. Press **▼** or **▲** to browse functions.
- Highlight the desired function, then press **M** to enter the sub-menu.
 - Press **▼** or **▲** to browse sub-menus, then press **M** to highlight the desired function.
 - Press **▼** or **▲** to highlight an option, then press **M** to confirm the settings and exit the current screen.
4. Press **E** to exit the current screen.

10.1 – OSD Menu Functions

Input Source	DP1	N/A
	DP2	N/A
	HDMI1	N/A
	HDMI2	N/A
Brightness/ Contrast	Brightness	0-100
	Blacklevel	0-100
	Contrast	0-100
	DCR	Off/On
Color Setting	Gamma	1.8/2.0/2.2/2.4/2.6
	Pictrue Mode	Standard/Picture/Movie/Game/FPS/RTS
	Color Temperature	Warm/Cool/USER
	Low Blue Light	0-100
	Hue	0-100
	Saturation	0-100
Picture Quality Setting	Sharpness	0-100
	Response Time	On/High/Middle/Low
	Noise Reduction	On/High/Middle/Low
	Dynamic Luminous Control	Off/On
Display	Aspect Ratio	Wide Screen/4:3/1:1/Auto
	LedMode	Normal/OFF/Flicker
Audio	Mute	Off/On
	Volume	0-100
	Audio Source	DP1/DP2/HDMI1/HDMI2
Multi-Window	Multi-Window	OFF/PIP Mode/PBP 2Win
	Sub Win2 Input	DP1/DP2/HDMI1/HDMI2
	PIP Size	Small/Medium/Large
	PIP Position	TopRight/TopLeft/BottomRight/BottomLeft
	Swap	N/A
OSD	Language	English/简体中文/한국어/РУССКИЙ/Español/日本語/Francais/ Deutsch/Italian
	OSD H-Position	0-100
	OSD V-Position	0-100
	OSD Transparency	0-100
	OSD Time Out	5-100
	OSD Rotation	Normal/90/180/270
Other	Adaptive-Sync	Off/On
	Reset	N/A

11. ECO Modes and Gameplus Switching

1. Press any one of the buttons (M, ▼, ▲, E, ⏻) to activate the navigation window.



2. Press ▼ button to switch Gameplus modes. According to the needs of your game, Choose the corresponding game icon. These game icons are primarily designed to optimize your aim during shooting games, though they can be used for other scenarios.



3. Press ▲ button to switch ECO modes. These modes include Standard, Text, Movie, Game, FPS, and RTS and can be used to optimize settings according to your activity. Standard mode is suitable for most activities.

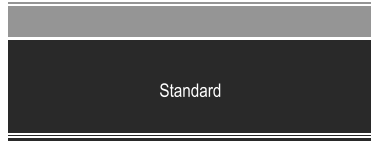

12. Technical Specifications

Model	LC-M34-UWQHD-100-C-V3
Screen Size	34"
Aspect Ratio	21:9
Backlight	E-LED
Brightness	300 cd/m ² (typ.)
Panel	VA
Resolution	DP1.2: 3440*1440@100Hz HDMI2.0: 3440*1440@100Hz HDMI1.4: 3440*1440@60Hz
Refresh Rate	100Hz
Response Time	OD 6ms
Viewing Angle	178°(H) / 178°(V)
Contrast Ratio	3000:1
VESA Mounting	75 x 75
Colours	16.7m
Adaptive-sync	Yes
Signal Input	DP1.2*1, HDMI1.4*2, HDMI2.0*1
Audio	
Speakers	No
Audio Out	Yes
Accessories	
Power	100-240 V~, 50/60 Hz, 2,0A
DisplayPort Cable	Yes
Additional Functions	
Low Blue Light	Yes
Flicker Free	Yes
Physical Dimensions	
Dimensions (w/ Stand)	808.65*454.19*225.58mm
Dimensions (w/o Stand)	808.65*363.33*123.12mm
Net Weight	7,35kg
Gross Weight	9,5kg

TABLE DES MATIÈRES

1. Précautions relatives à la sécurité
2. Maintenance
3. Contenu de la boîte
4. Vue d'ensemble du produit
5. Installation du socle
6. Montage mural
7. Les options de connectivité
8. Utilisation de base
9. Témoin lumineux
- 10 OSD
11. Commutation Modes ECO et Gameplus
12. Spécifications techniques

1. Précautions relatives à la sécurité

N'exposez pas le moniteur à un environnement humide, à la pluie ou à d'autres liquides. Afin d'éviter tout choc dû à des risques électriques ou mécaniques, n'ouvrez pas le boîtier du moniteur.

Fonctionnement :

- Maintenez le moniteur à l'abri de la lumière directe du soleil ou d'autres sources de chaleur comme les convecteurs.
- Maintenez le moniteur éloigné de tout liquide.
- Retirez tout objet qui pourrait tomber dans les orifices de ventilation.
- Afin d'éviter toute surchauffe, n'obstruez pas les orifices de ventilation.
- Ne heurtez pas et ne laissez pas tomber le moniteur.

2. Maintenance

ATTENTION : Débranchez le cordon d'alimentation de la prise murale avant de nettoyer le moniteur.

- Pour nettoyer votre écran antistatique, humidifiez légèrement un chiffon doux et propre avec de l'eau.
- Si possible, veuillez utiliser un chiffon spécial de nettoyage d'écran.
- N'utilisez pas de diluant, de benzène, d'ammoniac, de nettoyant abrasif ni d'air comprimé.
- Des solutions de nettoyage inappropriées peuvent endommager le moniteur ou laisser un film laiteux sur l'écran ou le boîtier.
- Débranchez le moniteur si vous ne prévoyez pas de l'utiliser pendant une période prolongée.
- N'exposez pas le moniteur à la poussière, aux liquides ou à un environnement humide.
- Si le moniteur entre en contact avec un liquide, essuyez-le immédiatement avec un chiffon sec.
- En cas de liquide renversé dans les orifices de ventilation, n'utilisez plus le moniteur. Veuillez contacter un technicien de maintenance professionnel.

Rappel légal :



Les termes HDMI, HDMI High-Definition Multimedia Interface et le logo HDMI sont des marques de commerce ou des marques déposées de la HDMI Licensing Administrator, Inc. aux États-Unis et dans d'autres pays.

3. Contenu de la boîte



Moniteur



Tige de support



Base du socle



Serre câble

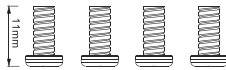

Vis

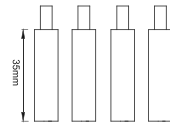

Vis
(pour montage mural)

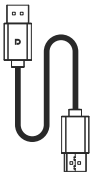

Câble DP



Câble d'alimentation



Tournevis



Mode d'emploi



Des vis supplémentaires peuvent être incluses en secours.

4. Vue d'ensemble du produit

4.1 Bouton du moniteur

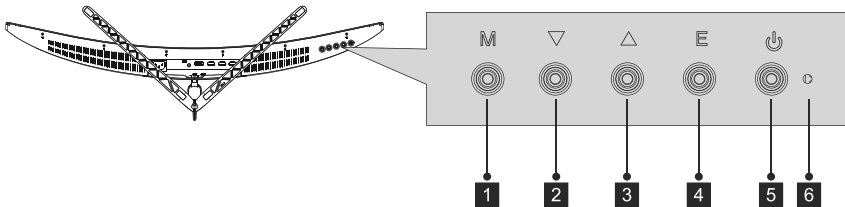

- 1 **M Bouton Menu** : appuyez sur le bouton pour afficher le menu OSD ou accéder aux sous-menus.
- 2 **▼ Bouton Bas** : appuyez sur le bouton pour déplacer le curseur vers le bas dans les menus.
- 3 **▲ Bouton Haut** : appuyez sur le bouton pour déplacer le curseur vers le haut dans les menus.
- 4 **E Bouton Quitter** : Appuyez pour quitter.
- 5 **🔌 Bouton d'alimentation** : Appuyez pour allumer ou éteindre le moniteur.
- 6 **Voyant LED** : Change de couleur pour indiquer l'état.

4.2 Ports du moniteur

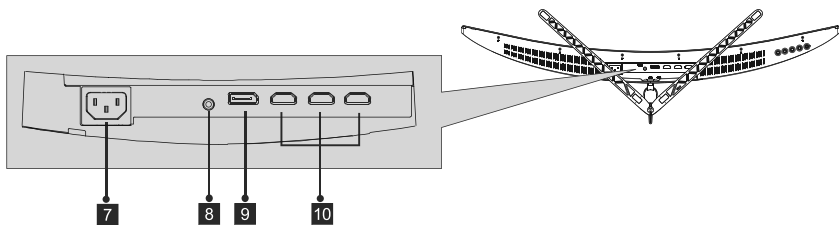

- 7 **Connecteur d'alimentation** : insérez le câble d'alimentation pour alimenter le moniteur.
- 8 **Sortie audio** : insérez une extrémité du câble audio dans la sortie audio de l'ordinateur pour transmettre les signaux audio de votre moniteur.
- 9 **Connecteur** : insérez une extrémité du câble DP dans la sortie DP de l'ordinateur et connectez l'autre extrémité au port DP du moniteur.
- 10 **Connecteurs HDMI** : insérez une extrémité du câble HDMI dans la sortie HDMI de l'ordinateur et connectez l'autre extrémité au port HDMI du moniteur.

5. Installation du socle



Maintenez la mousse en place sous le moniteur avant de fixer le support.

1. Ouvrez l'emballage, sortez-en le produit sans retirer la mousse et placez-le délicatement sur un bureau ou une table. Retirez ensuite la tige, le serre-câble et la base, utilisez le tournevis et une vis pour fixer la base à la tige.

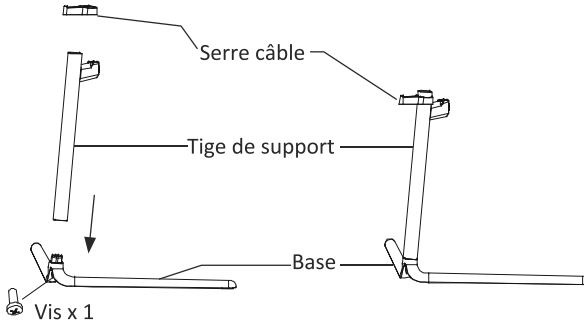

2. Retirez la mousse qui recouvre le bas du moniteur, puis retirez le convertisseur à l'arrière du moniteur. Utilisez ensuite deux vis pour fixer le convertisseur sur la tige.

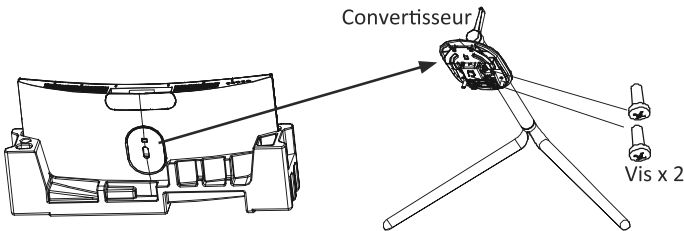

3. Fixez le convertisseur avec la tige et la base à l'arrière du moniteur. Retirez ensuite la mousse sur le moniteur et placez-la sur le bureau. Appuyez sur le bouton pour retirer le moniteur du support et le démonter ainsi facilement.

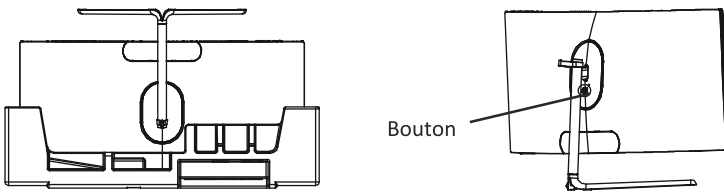

Assurez-vous que le moniteur est posé sur une surface plane avant de retirer le socle.

6. Montage mural



Ce moniteur comprend uniquement les vis qui peuvent être nécessaires lors de la fixation de celui-ci à un support de type VESA 75*75 mm. Aucun accessoire de montage ou support VESA n'est inclus.

1. Ouvrez l'emballage, sortez-en le produit sans retirer la mousse et posez-le délicatement sur un bureau ou une table. Retirez les pièces supplémentaires et la mousse qui recouvre l'arrière du moniteur. Enfoncez le bouton de dégagement pour retirer la plaque socle. Si le moniteur était déjà fixé au socle, retirez ce dernier.

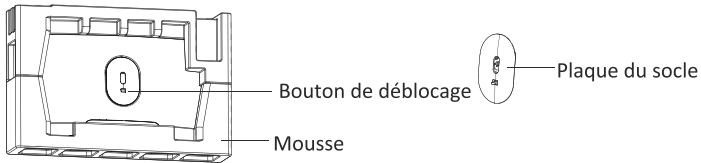

2. Retirez les vis d'origine x4 (①) de l'ouverture à l'arrière du moniteur.
3. Suivez les instructions reçues avec votre support, socle ou accessoire et installez le moniteur au mur ou sur la fixation comme souhaité. N'oubliez pas d'utiliser les 4 vis fournies pour le moniteur. Reportez-vous à l'image (②) pour le bon placement des vis.

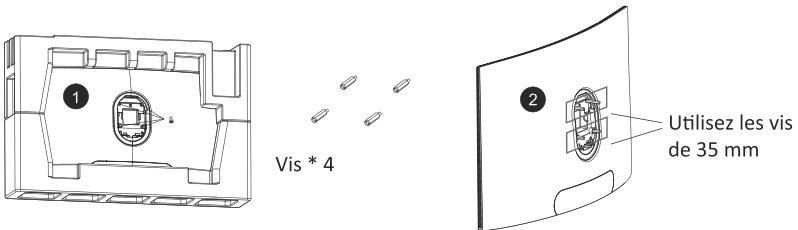

Ne jetez pas les vis d'origine. Elles pourraient être nécessaires pour une utilisation future.

4. Suivez les instructions reçues avec votre support, socle ou accessoire et installez le moniteur au mur ou sur la fixation comme souhaité.

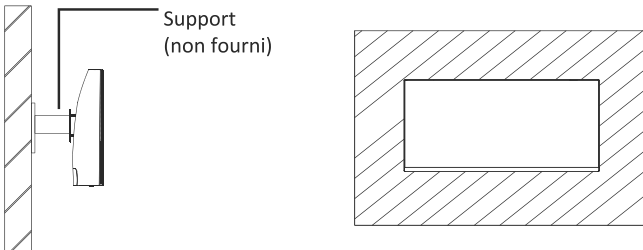

7. Les options de connectivité

7.1 Connexion du câble d'alimentation

Connectez le câble d'alimentation fourni au connecteur d'alimentation, puis branchez l'autre extrémité dans une prise murale.

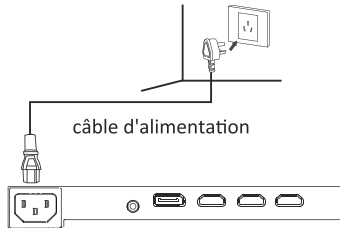

7.2 Branchement de vos écouteurs

Branchez vos écouteurs pour transmettre les signaux audio de votre moniteur. Si vos écouteurs sont connectés au moniteur et que les périphériques audio sont connectés à votre ordinateur en même temps, les périphériques audio ne produiront pas de son. Écouteurs et autres appareils audio non inclus.

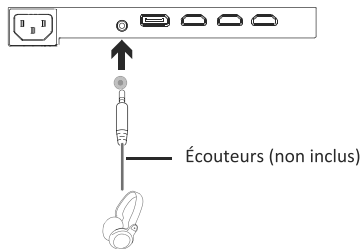

7.3 Connectivité HDMI

Pour que le moniteur reçoive les signaux HDMI de l'ordinateur, utilisez un câble HDMI pour connecter le moniteur à l'ordinateur.

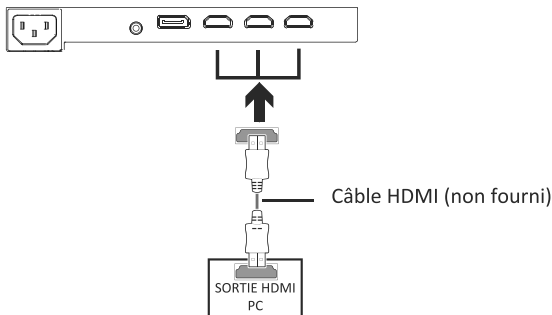

7.4 Connectivité DP

Pour que le moniteur reçoive les signaux DP de l'ordinateur, utilisez un câble DP pour connecter le moniteur à l'ordinateur.

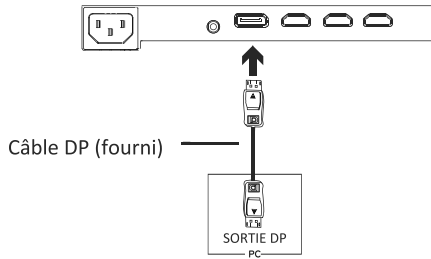

8. Opération de base

1. Insérez une extrémité du câble DP dans la carte graphique de votre PC. Un câble HDMI peut également être utilisé. Aucun câble HDMI n'est inclus.
2. Branchez l'autre extrémité du câble sur le connecteur correspondant de votre moniteur.

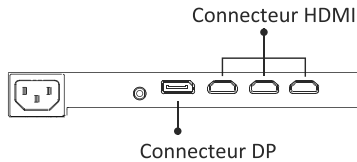

3. Connectez le câble d'alimentation à votre moniteur, puis connectez l'autre extrémité à votre source d'alimentation. Il est recommandé d'utiliser un parasurtenseur avec une tension adéquate si une prise murale ne peut pas être atteinte directement.
4. Localisez le bouton d'alimentation sur le moniteur et appuyez dessus pour allumer le moniteur.

9. Témoin lumineux

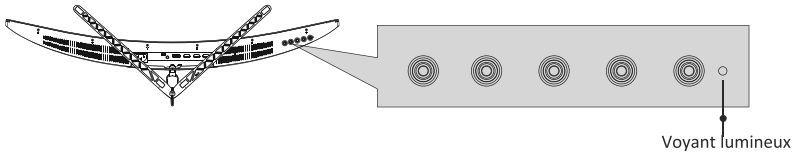

Une lumière bleue continue indique que l'appareil est allumé et que le moniteur fonctionne normalement. Une lumière clignotante bleue indique qu'aucune source vidéo, aucun signal horizontal ou vertical n'a été détecté ou que la tension est faible. Veuillez vous assurer que votre ordinateur est allumé et que tous les câbles vidéo sont correctement branchés et/ou insérés.

10. OSD

Le menu d'affichage à l'écran (OSD) peut être utilisé pour régler les paramètres de votre moniteur et apparaît à l'écran après avoir allumé le moniteur et appuyé sur le bouton **M**.

 Lorsque vous utilisez le moniteur pour la première fois, les paramètres se règlent automatiquement sur les valeurs optimales en fonction de la configuration et des composants de votre ordinateur, etc.

1. Appuyez sur l'un des boutons (**M**, **▼**, **▲**, **E**, ) pour activer la fenêtre de navigation.



2. Appuyez sur **M**  pour entrer dans le menu OSD.

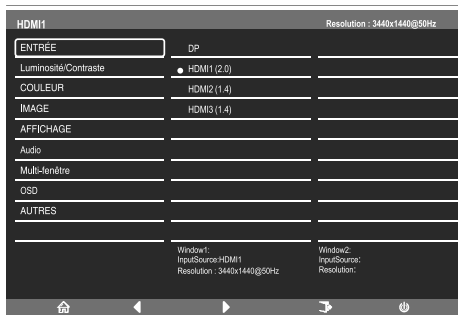

3. Appuyez sur **▼** ou **▲** pour parcourir les fonctions.
 - Mettez en surbrillance la fonction souhaitée, puis appuyez sur **M** pour accéder au sous-menu.
 - Appuyez sur **▼** ou **▲** pour parcourir les sous-menus, puis appuyez sur **M** pour mettre en surbrillance la fonction souhaitée.
 - Appuyez sur **▼** ou **▲** pour mettre une option en surbrillance, puis appuyez sur **M** pour confirmer les paramètres et quitter l'écran actuel.
4. Appuyez sur **E** pour quitter l'écran actuel.

10.1 Fonctions du menu OSD

ENTRÉE	DP	N/A
	HDMI1	N/A
	HDMI2	N/A
	HDMI3	N/A
Luminosité/ Contraste	Luminosité	0-100
	Blacklevel	0-100
	Contraste	0-100
	DCR	Off/On
COULEUR	Gamma	1.8/2.0/2.2/2.4/2.6
	Format de l'image	Standard/Picture/Movie/Game/FPS/RTS
	Température de l'image	Chaude/Froide/Utilisateur
	Low Blue Light	0-100
	Hue	0-100
	Saturation	0-100
IMAGE	Finesse	0-100
	Temps de réponse	Off/Haut/Moyen/Bas
	Noise Reduction	Off/Haut/Moyen/Bas
	Dynamic Luminous Control	Off/On
AFFICHAGE	Ratio d'affichage	Ecran large/4:3/1:1/Auto
	LedMode	Normal/OFF/Flicker
Audio	Muet	Off/On
	Volume	0-100
	Source Audio	AutoSource
Multi-fenêtre	Multi-fenêtre[PIP/PBP]	OFF/PIP Mode/PBP 2Win
	Sub Win2 Input	DP1//HDMI1/HDMI2/HDMI3
	Taille PIP	Petite/Moyenne/Large
	Position PIP	Haut-Droite/Haut-Gauche/Bas-droit/Bas-gauche
	Swap	N/A
OSD	Language	English/简体中文/한국어/Русский/Español/日本語/Français/Deutsch/Italian
	OSD H-Position	0-100
	OSD V-Position	0-100
	Transparence du menu OSD	0-100
	OSD Time Out	5-100
	Rotation OSD	Normal/90/180/270
AUTRES	Adaptive-Sync	Off/On
	Reset	N/A

11. Commutation Modes ECO et Gameplus

1. Appuyez sur l'un des boutons (M, ▼, ▲, E, ⏻) pour activer la fenêtre de navigation.



2. Appuyez sur le bouton ▼ pour changer de mode Gameplus. Selon les besoins de votre jeu, choisissez l'icône de jeu correspondante. Ces icônes de jeu sont principalement conçues pour optimiser votre objectif pendant les jeux de tir, bien qu'elles puissent être utilisées pour d'autres scénarios.



3. Appuyez sur le bouton ▲ pour changer de mode ECO. Ces modes incluent les modes Standard, Texte, Film, Jeu, FPS et RTS et peuvent être utilisés pour optimiser les paramètres en fonction de votre activité. Le mode standard convient à la plupart des activités.

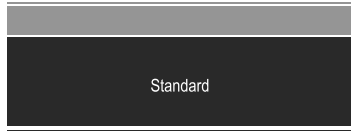

12. Spécifications techniques

Modèle	LC-M34-UWQHD-100-C-V3
Taille d'écran	34"
Proportions	21:9
Rétroéclairage	E-LED
Luminosité	300 cd/m ² (typ.)
Panneau	VA
Résolution	DP1.2: 3440*1440@100Hz HDMI2.0 : 3440*1440@100Hz HDMI1.4 : 3440*1440@60Hz
Taux de rafraîchissement	100Hz
Temps de réponse	OD 6ms
Angles de vue	178°(H) / 178°(V)
Taux de contraste	3000:1
Montage VESA	75 X 75
Couleurs	16,7m
Adaptive-sync	Oui
Entrées de signal	DP1.2*1, HDMI1.4*2, HDMI2.0*1
Audio	
Haut-parleurs	Aucune
Sortie Audio	Oui
Accessoires	
Alimentation	100-240 V~, 50/60 Hz, 2,0A
Câble DisplayPort	Oui
Fonctions supplémentaires	
Faible lumière bleue	Oui
Sans scintillement	Oui
Dimensions physiques	
Dimensions (avec socle)	808,65*454,19*225,58mm
Dimensions (sans socle)	808,65*363,33*123,12mm
Poids net	7,35kg
Poids brut	9,5kg

TABLA DE CONTENIDO

1. Precauciones de seguridad
2. Mantenimiento
3. Contenido de la caja
4. Información general del producto
5. Instalación del pedestal
6. Instalación en pared
7. Opciones de conectividad
8. Funcionamiento básico
9. Indicador luminoso
10. Menús OSD
11. Cambio a los modos ECO y Gameplus
12. Especificaciones técnicas

1. Precauciones de seguridad

No exponga el monitor a un entorno húmedo, a la lluvia ni a otros líquidos. Para evitar descargas eléctricas debidas a riesgos eléctricos o mecánicos, no abra la carcasa del monitor.

Funcionamiento:

- Mantenga el monitor alejado de la luz solar directa u otras fuentes de calor como puede ser una estufa.
- Mantenga el monitor alejado de cualquier líquido.
- Retire cualquier objeto que pueda caer en los orificios de ventilación.
- Para evitar el sobrecalentamiento, no bloquee los orificios de ventilación.
- No golpee ni deje caer el monitor.

2. Mantenimiento

PRECAUCIÓN: Desenchufe el cable de alimentación de la toma de corriente antes de limpiar el monitor.

- Para limpiar la pantalla, humedezca ligeramente un paño suave y limpio con agua.
- Si es posible, utilice una toallita especial para limpiar pantallas.
- No utilice benceno, diluyentes, amoníaco, limpiadores abrasivos o aire comprimido.
- Las soluciones de limpieza inadecuadas pueden dañar el monitor o dejar una película lechosa en la pantalla o la carcasa.
- Desenchufe el monitor si no la va a utilizar durante un prolongado período de tiempo.
- No exponga el monitor al polvo, a líquidos o a un entorno húmedo.
- En caso de que el monitor entre en contacto con líquidos, límpielo inmediatamente con un paño seco.
- Si se derrama líquido en los orificios de ventilación, no use más el monitor. Póngase en contacto con un técnico de servicio profesional.

Aviso legal:



Los términos HDMI, HDMI High-Definition Multimedia Interface y el logotipo de HDMI son marcas comerciales o marcas registradas de HDMI Licensing, Administrator, Inc. en EE. UU. y otros países.

3. Contenido de la caja

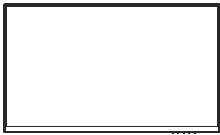

Monitor



Tubo del pedestal



Base del pedestal



Abrazadera para cables

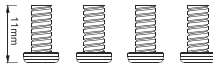

Tornillos

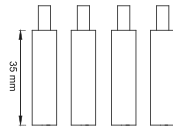

Tornillos
(para instalación en pared)

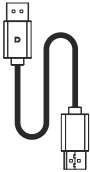

Cable DP

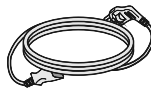

Cable de alimentación



Destornillador



Manual del usuario



Se pueden incluir tornillos adicionales de repuesto.

4. Información general del producto

4.1 Botones del monitor

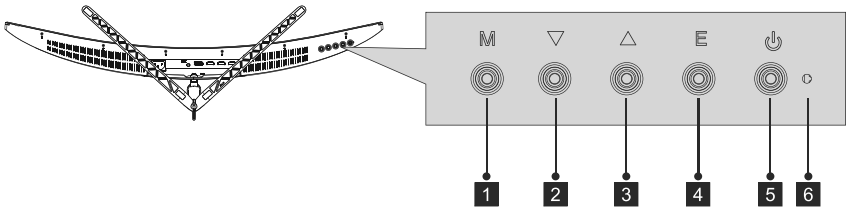

- 1 M Botón Menú:** presione este botón para mostrar los menús OSD o introducir los submenús.
- 2 ▼ Botón Abajo:** presione este botón para desplazarse hacia abajo por los menús.
- 3 ▲ Botón Arriba:** presione este botón para desplazarse hacia arriba por los menús.
- 4 E Botón Salir:** Presione este botón para salir.
- 5  Botón de alimentación:** Presione este botón para encender o apagar el monitor.
- 6 Indicador LED:** Cambia los colores para indicar el estado.

4.2 Puertos del monitor

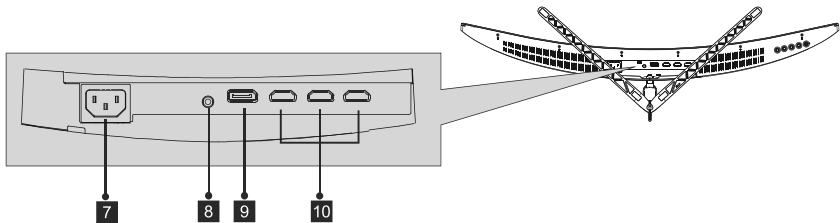

- 7 Conector de alimentación:** inserte el cable de alimentación para proporcionar energía al monitor.
- 8 Salida de audio:** inserte un extremo del cable de audio en la salida de audio de su PC para recibir las señales de audio del monitor.
- 9 Conector:** inserte un extremo del cable DP en la salida DP de su PC y conecte el otro extremo al puerto DP del monitor.
- 10 Conectores HDMI:** inserte un extremo del cable HDMI en la salida HDMI de su PC y conecte el otro extremo al puerto HDMI del monitor.

5. Instalación del pedestal

 Mantenga la espuma debajo del monitor antes de colocar el pedestal.

1. Abra el paquete, saque el producto con la espuma todavía acoplada y colóquelo suavemente sobre una mesa o escritorio. Luego, saque el tubo, la abrazadera para cables y la base. Use el destornillador y un tornillo para fijar la base al tubo.

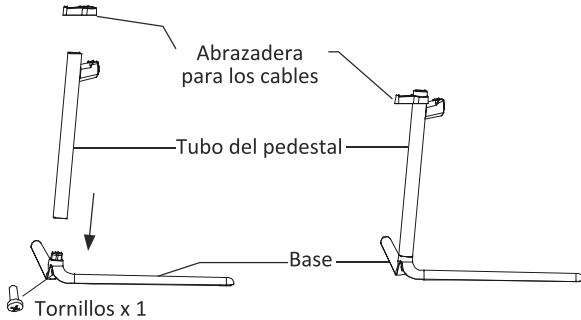

2. Retire la espuma que cubre la parte inferior del monitor y, a continuación, luego retire el convertidor de la parte posterior del monitor. Luego, use dos tornillos para fijar el convertidor al tubo.

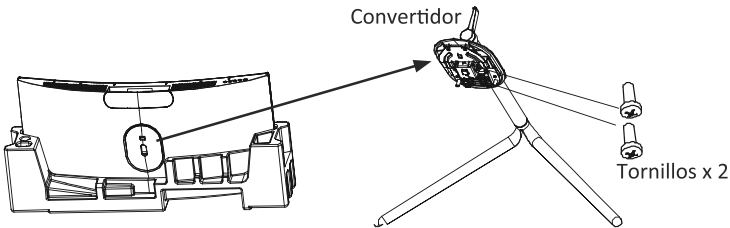

3. Vuelva a acoplar el convertidor con el tubo y la base en la parte posterior del monitor. Luego, retire la espuma del monitor y colóquela sobre el escritorio. Presione el botón para quitar el monitor del soporte y desmontarlo fácilmente.

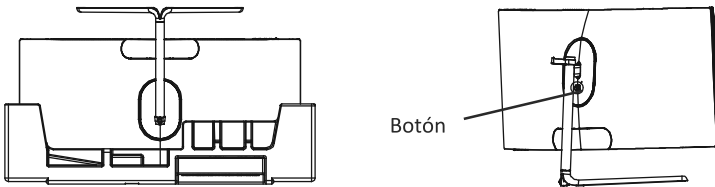

 Asegúrese de colocar el monitor sobre una superficie plana antes de quitar el pedestal.

6. Instalación en pared



Este monitor solo incluye tornillos que pueden usarse al conectar el monitor a un soporte tipo VESA de 75*75 mm. No se incluye un soporte VESA ni un accesorio de montaje.

1. Abra el paquete, saque el producto con la espuma todavía acoplada y colóquelo suavemente sobre una mesa o escritorio. Retire las piezas adicionales y la espuma que cubre la parte posterior del monitor. Presione el botón de liberación para quitar la placa del pedestal. Si el monitor ya estaba acoplado al pedestal, retire el este.

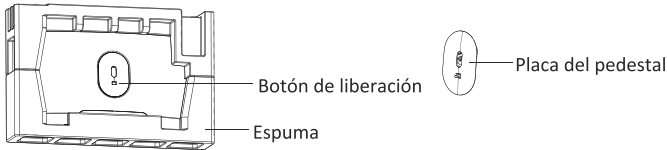

2. Retire los tornillos originales x4 (1) de la abertura en la parte posterior del monitor.
3. Siga las instrucciones recibidas con el soporte, el pedestal o los accesorios e instale el monitor en la pared o el mobiliario como desee. Recuerde usar los 4 tornillos incluidos cuando instale el monitor. Consulte la imagen (2) para ver la correcta colocación de los tornillos.

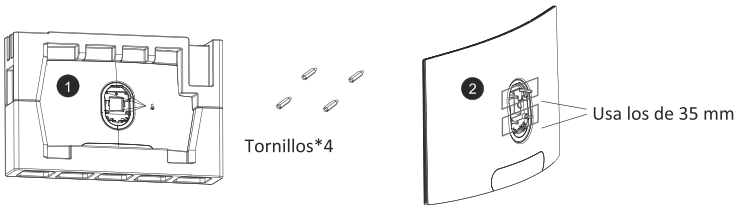

No deseche los tornillos originales, ya que los puede necesitar en otro momento.

4. Siga las instrucciones recibidas con el soporte, el pedestal o los accesorios e instale el monitor en la pared o el mobiliario como desee.

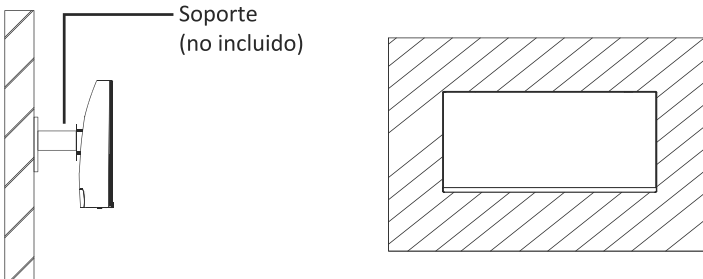

7. Opciones de conectividad

7.1 Conectar el cable de alimentación

Conecte el cable de alimentación incluido al conector de alimentación y, a continuación, enchufe el otro extremo en una toma de corriente.

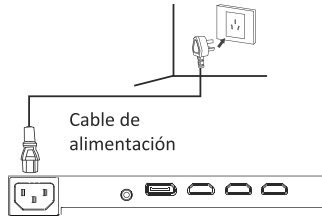

7.2 Conectar los auriculares

Enchufe los auriculares para recibir señales de audio del monitor. Si los auriculares están conectados al monitor y los dispositivos de audio están conectados al equipo al mismo tiempo, los dispositivos de audio no producirán sonido. Los auriculares y otros dispositivos de audio no se incluyen.

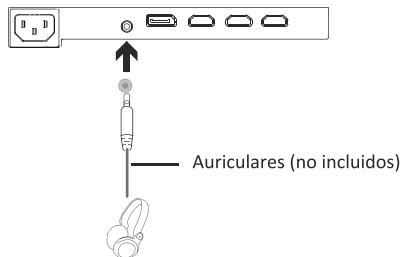

7.3 Conectividad HDMI

Para que el monitor reciba señales HDMI de su PC, use el cable HDMI para conectar el monitor y su PC.

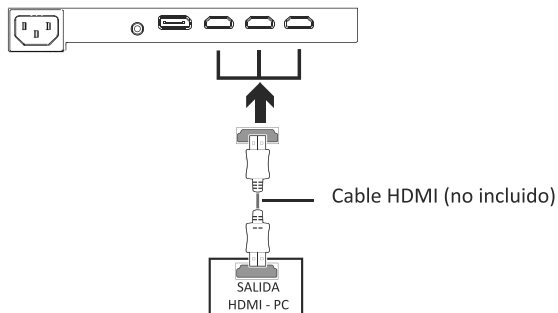

7.4 Conectividad DP

Para que el monitor reciba señales DP de su PC, use el cable DP para conectar el monitor y su PC.

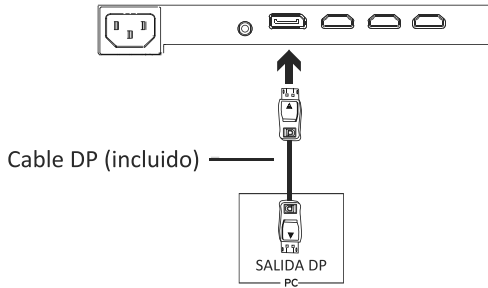

8. Funcionamiento básico

1. Inserte un extremo del cable DP en la tarjeta gráfica de su PC. También se puede usar un cable HDMI. Los cables HDMI no se incluyen.
2. Enchufe el otro extremo del cable en el conector correspondiente del monitor.

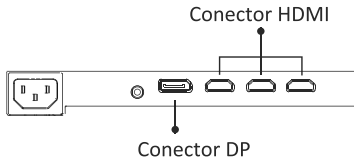

3. Conecte el cable de alimentación al monitor y, a continuación, conecte el otro extremo a la fuente de alimentación. Se recomienda utilizar un protector contra sobretensiones con un voltaje adecuado si no se puede acceder directamente a una toma de corriente.
4. Localice el botón de alimentación del monitor y presiónelo para encenderlo.

9. Indicador luminoso

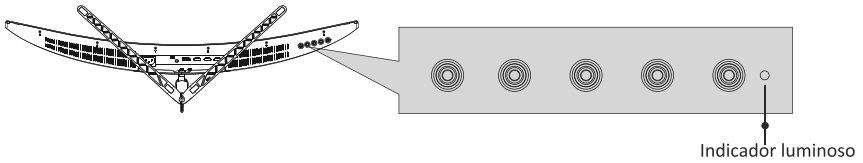

La luz azul fija indica que la alimentación está activada y que el monitor está funcionando con normalidad. La luz azul intermitente indica que no hay fuente de vídeo, que no se ha detectado ninguna señal horizontal o vertical o que el voltaje es bajo. Asegúrese de que el equipo esté encendido y que todos los cables de vídeo estén completamente insertados y/o conectados.

10. Menús OSD

El menú de visualización en pantalla (OSD) se puede usar para ajustar la configuración del monitor y aparece en la pantalla después de encender el monitor y presionar el botón **M**.

 Cuando use el monitor por primera vez, la configuración se ajustará automáticamente a la configuración óptima de acuerdo con la configuración y las partes de su PC, etc.

1. Presione cualquiera de los botones (**M**, **▼**, **▲**, **E**, ) para activar la ventana de navegación.

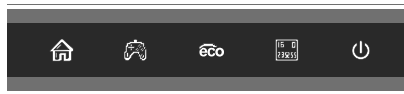

2. Presione **M**  para entrar en los menús OSD.

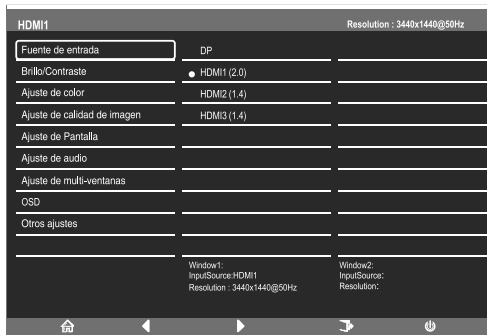

3. Presione **▼** o **▲** para examinar funciones.

- Resalte la función que desee y, a continuación, presione **M** para entrar en el submenú.
- Presione **▼** o **▲** para navegar por los submenús y, a continuación, presione **M** para resaltar la función deseada.
- Presione **▼** o **▲** para resaltar una opción y, a continuación, presione **M** para confirmar la configuración y salir de la pantalla actual.

4. Presione **E** para salir de la pantalla actual.

10.1 Funciones de los menús OSD

Fuente de entrada	DP	N/A
	HDMI1	N/A
	HDMI2	N/A
	HDMI3	N/A
Brillo/Contraste	Brillo	0-100
	Blacklevel	0-100
	Contraste	0-100
	DCR	Encender/Apagar
Ajuste de color	Gamma	1.8/2.0/2.2/2.4/2.6
	Modo de imagen	Estándar/imagen/Película/Juego/FPS/RTS
	Temperatura de color	Templado/Frío/USUARIO
	Low Blue Light	0-100
	Color	0-100
	Saturación	0-100
Ajuste de calidad de imagen	Definición	0-100
	Tiempo de respuesta	Apagar/Alto/Mediano/Bajo
	Reducción de ruido	Apagar/Alto/Mediano/Bajo
	Control luminoso dinámico	Encender/Apagar
Ajuste de Pantalla	Relación de aspecto	Pantalla completa/4:3/1:1/Auto
	LedMode	Normal/OFF/Flicker
Ajuste de audio	Silencio	Encender/Apagar
	Volumen	0-100
	Fuente de audio	—
Ajuste de multi-ventanas	Multi-ventana	Apagar/Modo PIP/Ven2PBP
	Entrada sub ven2	DP1//HDMI1/HDMI2/HDMI3
	Tamaño PIP	Pequeño/Mediano/Grande
	Posición PIP	Superior derecho/Superior izquierdo/Inferior derecho /Inferior izquierdo
	Intercambiar	N/A
OSD	Idioma	English/简体中文/한국어/РУССКИЙ/Español/日本語/Français/Deutsch/Italian
	OSD Posición horizontal	0-100
	OSD Posición vertical	0-100
	Transparencia OSD	0-100
	Tiempo acabado OSD	5-100
	Rotación OSD	Normal/90/180/270
Otros ajustes	Adaptive-Sync	Encender/Apagar
	Reiniciar	N/A

11. Cambio a los modos ECO y Gameplus

1. Presione cualquiera de los botones (M, ▼, ▲, E, ⏻) para activar la ventana de navegación.



2. Presione el botón ▼ para cambiar al modo Gameplus. Según las necesidades del juego, elija el icono del juego correspondiente. Estos iconos de juego están diseñados principalmente para optimizar su puntería durante los juegos de disparos, aunque se pueden usar para otros escenarios.



3. Presione el botón ▲ para cambiar los modos ECO. Estos modos incluyen Estándar, Texto, Película, Juego, FPS y RTS, y se pueden utilizar para optimizar la configuración de acuerdo con su actividad. El modo estándar es adecuado para la mayoría de las actividades.

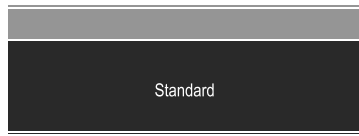

12. Especificaciones técnicas

Modelo	LC-M34-UWQHD-100-C-V3
Tamaño de la pantalla	34"
Relación de aspecto	21:9
Luz de fondo	E-LED
Brillo	300 cd/m ² (typ.)
Panel	VA
Resolución	DP1.2: 3440*1440 a 100 Hz HDMI2.0: 3440*1440 a 100 Hz HDMI1.4: 3440*1440 a 60 Hz
Tasa de actualización	100Hz
Tiempo de respuesta	OD 6ms
Ángulo de visión	178°(H) / 178°(V)
Relación de contraste	3000:1
Soporte VESA	75 X 75
Colores	16,7 m
Adaptive-sync	Sí
Señal de entrada	DP1.2*1, HDMI1.4*2, HDMI2.0*1
Audio	
Altavoces	No
Salida de audio	Sí
Accesorios	
Alimentación	100-240 V~, 50/60 Hz, 2,0A
Cable DisplayPort	Sí
Funciones adicionales	
Luz Azul baja	Sí
Sin parpadeos	Sí
Dimensiones físicas	
Dimensiones (con base)	808,65*454,19*225,58mm
Dimensiones (sin base)	808,65*363,33*123,12mm
Peso neto	7,35kg
Peso bruto	9,5kg

INDICE

1. Precauzioni sulla sicurezza
2. Manutenzione
3. Contenuto della confezione
4. Descrizione del prodotto
5. Installazione del supporto
6. Montaggio a parete
7. Opzioni di connettività
8. Funzionamento di base
9. Indicatore
10. OSD
11. Commutazione modalità ECO e Gameplus
12. Specifiche tecniche

1. Precauzioni sulla sicurezza

Non esporre il monitor a un ambiente umido, pioggia o altri liquidi. Non aprire l'alloggiamento del monitor per evitare scosse dovute a rischi elettrici o meccanici.

Funzionamento:

- Tenere il monitor lontano dalla luce solare diretta o da altre fonti di calore come stufe.
- Tenere il monitor lontano da qualsiasi liquido.
- Rimuovere eventuali oggetti che potrebbero cadere nei fori di ventilazione.
- Non ostruire i fori di ventilazione per evitare il surriscaldamento.
- Non far subir urti né far cadere il monitor.

2. Manutenzione

ATTENZIONE: Scollegare il cavo di alimentazione dalla presa prima di pulire il monitor.

- Per pulire lo schermo, inumidire leggermente un panno morbido e pulito.
- Utilizzare uno speciale panno per la pulizia dello schermo, se possibile.
- Non utilizzare benzene, solventi, ammoniacca, detergenti abrasivi o aria compressa.
- Le soluzioni di pulizia inadeguate potrebbero danneggiare il monitor o lasciare una pellicola lattiginosa sullo schermo o sull'alloggiamento.
- Scollegare il monitor se non lo si utilizza per un periodo di tempo più lungo.
- Non esporre il monitor a polvere, liquidi o ambienti umidi.
- Se il monitor viene a contatto con qualsiasi liquido, pulirlo immediatamente con un panno asciutto.
- In caso di versamento di liquido nei fori di ventilazione, non utilizzare più il monitor. Contattare un tecnico di assistenza professionale.

Avviso legale:



I termini HDMI, High-Definition Multimedia Interface e il logo HDMI sono marchi di fabbrica o marchi registrati di HDMI Licensing Administrator, Inc. negli Stati Uniti e in altri Paesi.

3. Contenuto della confezione



Monitor



Attacco supporto



Base supporto



Fermacavo

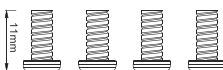

Viti

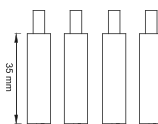

Viti
(per montaggio a parete)

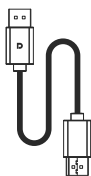

Cavo DP



Cavo di alimentazione



Cacciavite



Manuale Utente



Potrebbero essere incluse viti extra di ricambio.

4. Descrizione del prodotto

4.1 Tasti del monitor

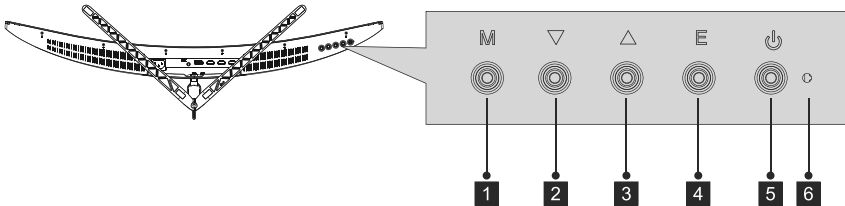

- 1 Tasto M Menu:** Premere per visualizzare il menu OSD o accedere ai menu secondari.
- 2 ▼ Tasto giù:** premere per spostarsi verso il basso nei menu.
- 3 ▲ Tasto su:** premere per spostarsi verso l'alto nei menu.
- 4 E Tasto Esci :** Premere per uscire.
- 5  Tasto di alimentazione:** Premere per accendere/spengere il monitor.
- 6 LED:** Cambia i colori per indicare lo stato.

4.2 Porte del monitor

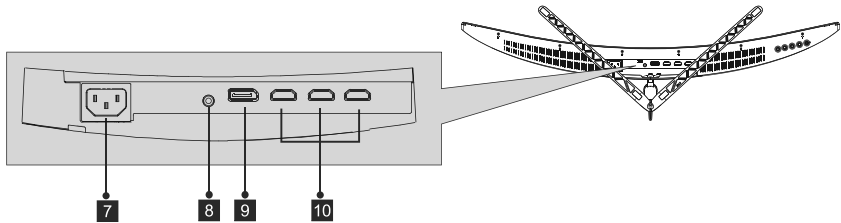

- 7 Connettore di alimentazione:** Inserire il cavo di alimentazione nell'alimentatore del monitor.
- 8 Uscita audio:** Inserire un'estremità del cavo audio nell'uscita audio del computer per ricevere i segnali audio del monitor.
- 9 Connettore:** Inserire un'estremità del cavo DP nell'uscita DP del computer e collegare l'altra estremità alla porta DP del monitor.
- 10 Connettori HDMI:** Inserire un'estremità del cavo HDMI nell'uscita HDMI del computer e collegare l'altra estremità alla porta HDMI del monitor.

5. Installazione del supporto

 Tenere il polistirolo sotto il monitor prima di fissare il supporto.

1. Aprire la confezione, estrarre il prodotto con la gommapiuma ancora fissata e posizionarlo delicatamente su una scrivania o un tavolo. Quindi, estrarre l'attacco, il fermacavo e la base, utilizzare il cacciavite e una vite per fissare la base all'attacco.

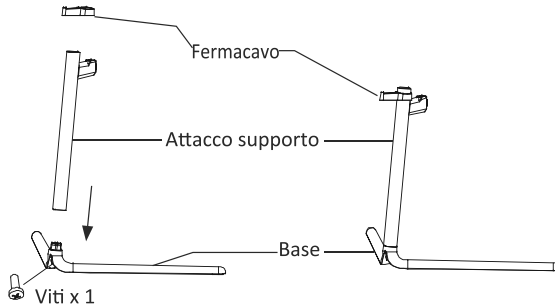

2. Rimuovere la gommapiuma che copre la parte inferiore del monitor, quindi rimuovere il convertitore sul retro del monitor. Quindi, utilizzare due viti per fissare il convertitore sull'attacco.

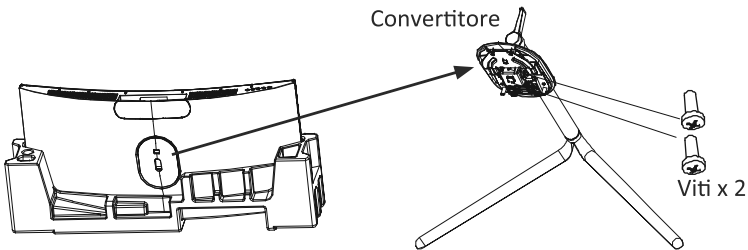

3. Fissare di nuovo il convertitore all'attacco e la base sul retro del monitor. Quindi, rimuovere la gommapiuma sul monitor e collocarla sul desktop. Premere il tasto per rimuovere il monitor dalla staffa e smontarla facilmente.

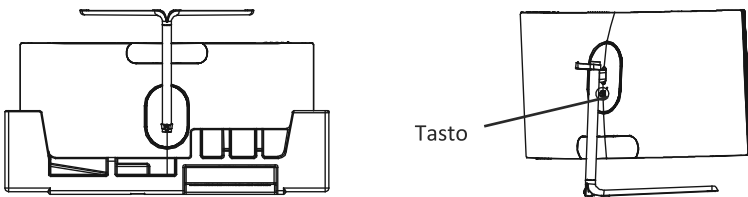

 Assicurarsi che il monitor sia posizionato su una superficie piana prima di rimuovere il supporto.

6. Montaggio a parete



Questo monitor include solo viti che possono essere utilizzate quando si collega il monitor a un supporto di tipo VESA 75*75 mm. Non sono inclusi accessori per montaggio o supporto VESA.

1. Aprire la confezione, estrarre il prodotto con la gommapiuma ancora fissata e posizionarlo delicatamente su una scrivania o un tavolo. Rimuovere le parti extra e la gommapiuma che copre il retro del monitor. Premere il tasto di rilascio per rimuovere la piastra del supporto. Se il monitor era già collegato al supporto, rimuovere il supporto.

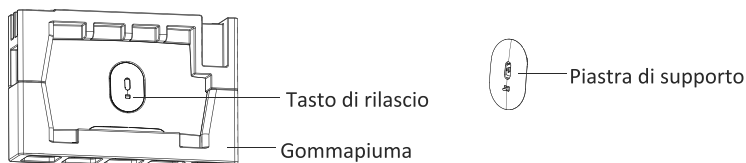

2. Rimuovere le viti originali x4 (1) dall'apertura sul retro del monitor.
3. Seguire le istruzioni ricevute con il dispositivo di montaggio, il supporto o l'accessorio e installare il monitor sulla parete o sul dispositivo di fissaggio come desiderato. Ricordarsi di usare le 4 viti incluse durante l'installazione del monitor. Fare riferimento all'immagine (2) per il corretto posizionamento della vite.

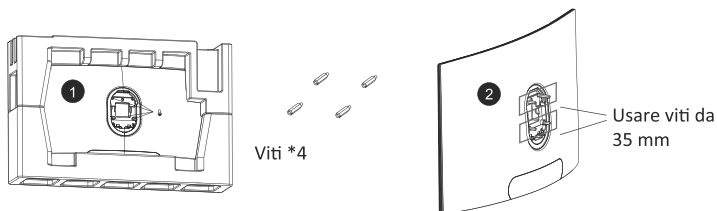

Non gettare le viti originali. Potrebbero essere necessarie in futuro.

4. Seguire le istruzioni ricevute con il dispositivo di montaggio, il supporto o l'accessorio e installare il monitor sulla parete o sul dispositivo di fissaggio come desiderato.

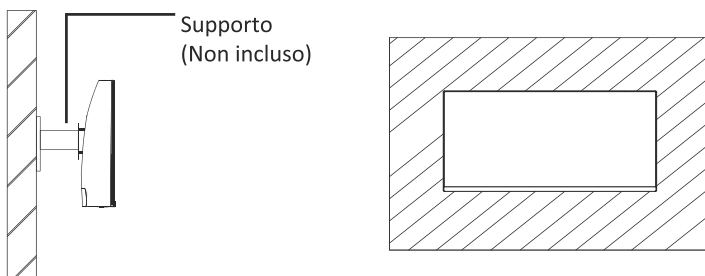

7. Opzioni di connettività

7.1 Collegamento del tasto di alimentazione

Collegare il cavo di alimentazione incluso al connettore di alimentazione, quindi inserire l'altra estremità in una presa a muro.



7.2 Collegamento degli auricolari

Collegare gli auricolari per ricevere segnali audio dal monitor. Se gli auricolari sono collegati al monitor e i dispositivi audio sono collegati al computer contemporaneamente, i dispositivi audio non producono alcun suono. Auricolari e altri dispositivi audio non inclusi.

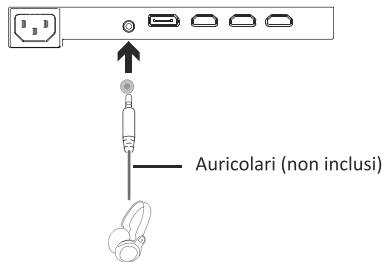

7.3 Connettività HDMI

Affinché il monitor riceva i segnali HDMI dal computer, utilizzare il cavo HDMI per collegare il monitor al computer.

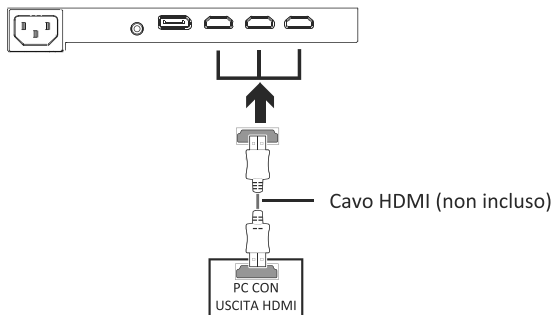

7.4 Connettività DP

Affinché il monitor riceva i segnali DP dal computer, utilizzare il cavo DP per collegare il monitor al computer.

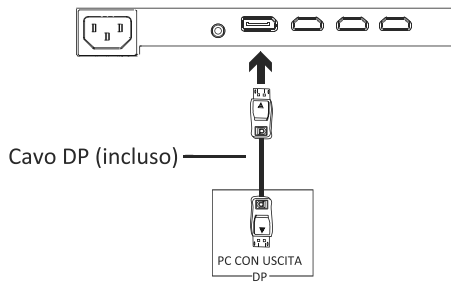

8. Operazione di base

1. Inserire un'estremità del cavo DP nella scheda grafica del PC. È inoltre possibile utilizzare un cavo HDMI. I cavi HDMI non sono inclusi.
2. Collegare l'altra estremità del cavo al corrispondente connettore del monitor.

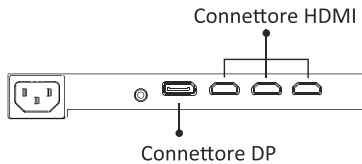

3. Collegare il cavo di alimentazione al monitor, quindi collegare l'altra estremità alla fonte di alimentazione. Si consiglia di utilizzare un limitatore di sovratensione con una tensione adeguata, se non è possibile raggiungere direttamente una presa a muro.
4. Individuare il tasto di accensione sul monitor e premerlo per accenderlo.

9. Indicatore

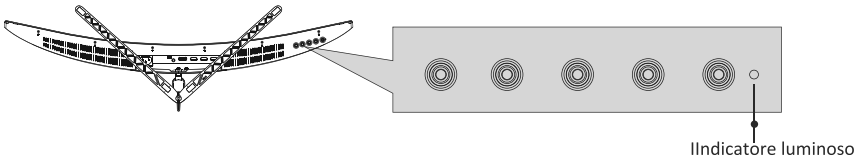

La luce blu fissa indica che l'alimentazione è accesa e il monitor funziona normalmente. La luce blu lampeggiante indica che non è stata rilevata alcuna sorgente video, nessun segnale orizzontale o verticale o che la tensione è bassa. Assicurarsi che il computer sia acceso e che tutti i cavi video siano inseriti e/o collegati completamente.

10. OSD

Il menu OSD (On-Screen Display) può essere utilizzato per regolare le impostazioni del monitor e appare sullo schermo dopo aver acceso il monitor e premuto il tasto M.

 Quando si utilizza il monitor per la prima volta, le impostazioni si adattano automaticamente alle impostazioni ottimali in base alla configurazione e alle parti del computer, ecc.

1. Premere un tasto (**M**, **▼**, **▲**, **E**, ) per attivare la finestra di navigazione.

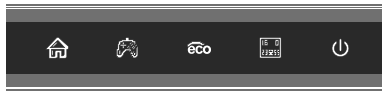

2. Premere **M**  per accedere al menu OSD.

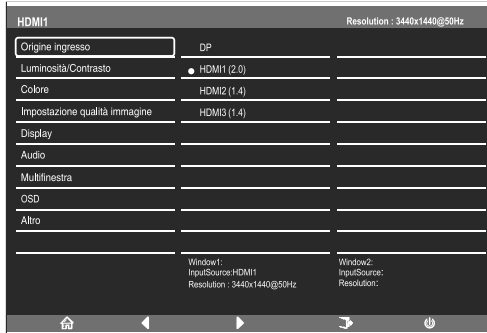

3. Premere **▼** o **▲** per passare tra le funzioni.
 - Evidenziare la funzione desiderata, quindi premere **M** per accedere al sottomenu.
 - Premere **▼** o **▲** per passare tra i menu secondari, quindi premere **M** per evidenziare la funzione desiderata.
 - Premere **▼** o **▲** per evidenziare un'opzione, quindi premere **M** per confermare le impostazioni e uscire dalla schermata attuale.
4. Premere **E** per uscire dal menu attuale.

10.1 Funzioni del menu OSD

Origine ingresso	DP	N/A
	HDMI1	N/A
	HDMI2	N/A
	HDMI3	N/A
Luminosità/ Contrasto	Luminosità	0-100
	Livello del nero	0-100
	Contrasto	0-100
	DCR	Attiva/Disattiva
Colore	Gamma	1.8/2.0/2.2/2.4/2.6
	Modalità immagine	Standard/Immagine/Film/Gioco/FPS/RTS
	Temperatura colore	Caldo/Freddo/Utente
	Luce blu bassa	0-100
	Tonalità	0-100
	Saturazione	0-100
Impostazione qualità immagine	Nitidezza	0-100
	Tempo di risposta	Disattiva/Alto/Medio/Basso
	Riduzione disturbi	Disattiva/Alto/Medio/Basso
	Controllo luminosità dinamica	Attiva/Disattiva
Display	Proporzioni	Widescreen/4:3/1:1/Auto
	Modalità LED	Normale/Disattiva/Sfarfallio
Audio	Disattiva audio	Attiva/Disattiva
	Volume	0-100
	Origine audio	——
Multifinestra	Multifinestra	Disattiva/Modalità PIP/PBP 2Win
	Input sec win 2	DP1//HDMI1/HDMI2/HDMI3
	Dimensioni PIP	Piccolo/Medio/Grande
	Posizione PIP	In alto a destra/In alto a sinistra/In basso a destra /In basso a sinistra
	Scambia	N/A
OSD	Lingua	English/简体中文/한국어/РУССКИЙ/Español/日本語/Français/ Deutsch/Italian
	Posizione O OSD	0-100
	Posizione V OSD	0-100
	Trasparenza OSD	0-100
	Timeout OSD	5-100
	Rotazione OSD	Normale/90/180/270
Altro	Adaptive-Sync	Attiva/Disattiva
	Ripristina	N/A

11. Commutazione modalità ECO e Gameplus

1. Premere un tasto (**M**, **▼**, **▲**, **E**, **⏻**) per attivare la finestra di navigazione.

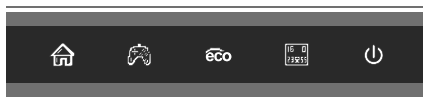

2. Premere il tasto **▼** per passare alle modalità Gameplus. In base alle esigenze del gioco, scegliere l'icona del gioco corrispondente. Queste icone di gioco sono progettate principalmente per ottimizzare l'obiettivo durante i giochi FPS, anche se possono essere utilizzati per altri scenari.



3. Premere il tasto **▲** per passare alle modalità ECO. Queste modalità includono Standard, Testo, Film, Gioco, FPS e RTS e possono essere utilizzati per ottimizzare le impostazioni in base alla propria attività. La modalità Standard è adatta per la maggior parte delle attività.

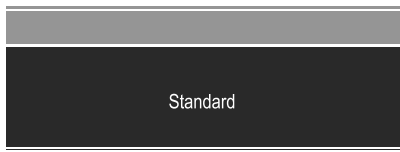

12. Specifiche tecniche

Modello	LC-M34-UWQHD-100-C-V3
Dimensioni schermo	34"
Proporzioni	21:9
Retroilluminazione	E-LED
Luminosità	300 cd/m ² (typ.)
Pannello	VA
Risoluzione	DP1.2 3440*1440 a 100 Hz HDMI2.0: 3440*1440 a 100 Hz HDMI1.4: 3440*1440 a 60 Hz
Frequenza di aggiornamento	100Hz
Tempo di risposta	OD 6 ms
Angolo di visione	178°(H) / 178°(V)
Rapporto di contrasto	3000:1
Supporto VESA	75 X 75
Colori	16,7 m
Adaptive-sync	Sì
Ingresso segnale	DP1.2*1, HDMI1.4*2, HDMI2.0*1
Audio	
Altoparlanti	No
Uscita audio	Sì
Accessori	
Alimentazione	100-240 V~, 50/60 Hz, 2,0A
Cavo DisplayPort	Sì
Altre funzioni	
Luce blu bassa	Sì
Antisfarfallio	Sì
Dimensioni fisiche	
Dimensioni (con supporto)	808,65*454,19*225,58mm
Dimensioni (senza supporto)	808,65*363,33*123,12mm
Peso netto	7,35kg
Peso lordo	9,5kg

LC-POWER™

Silent Power Electronics GmbH

Formerweg 8

47877 Willich

Germany

www.lc-power.com