

KIM 22R

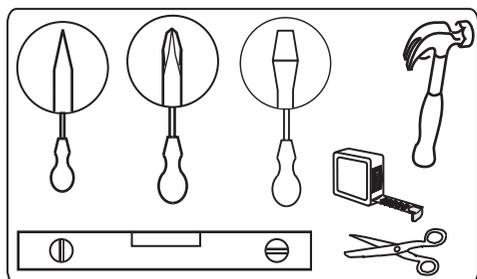

Issue: C261115N190122G

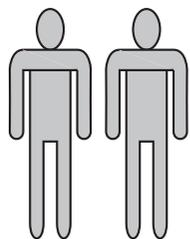
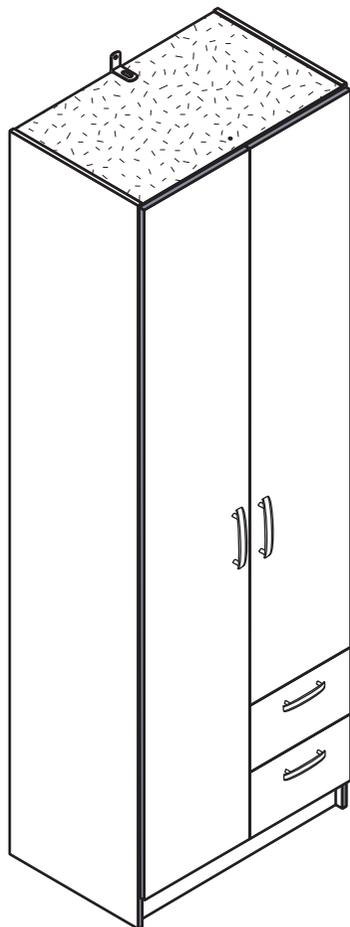
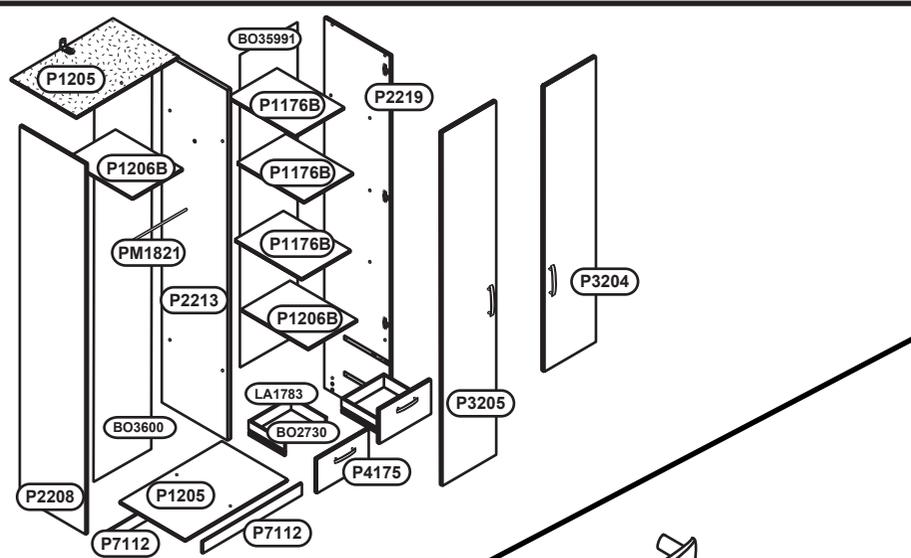

PM16951 x 4

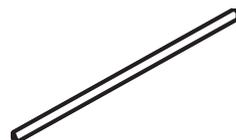

PM1821 x 1



FK1411 x 8



FK1214 x 2



FK1415 x 1



FK1201 x 12



FK1005 x 20



FK1322 x 8



FK1400 x 11



FK1981 x 4



GR1897 x 4



FK1235 x 1



FK1010 x 4

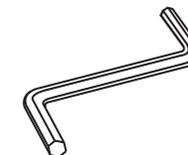

FK1013 x 1

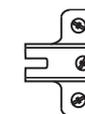

FK12641 x 6

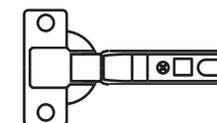

FK12541 x 6



FK1309 x 14



FK1301 x 8



FK1011 x 4



FK1515 x 60

1

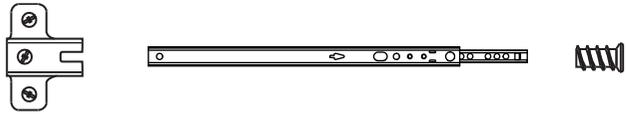

FK12641 x 3

PM16951 x 2

FK1301 x 4



P2219
2010 x 480mm

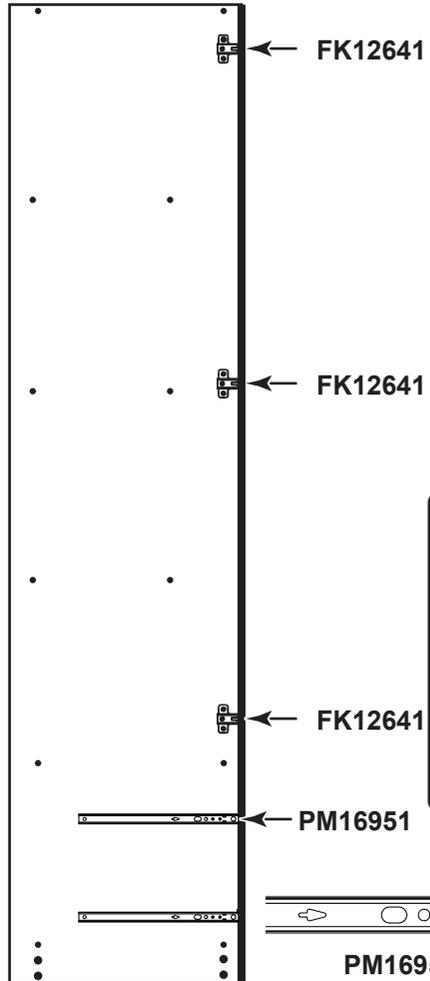
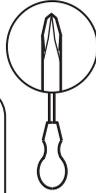
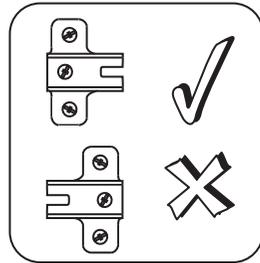

FK12641

FK12641

FK12641

PM16951

PM16951

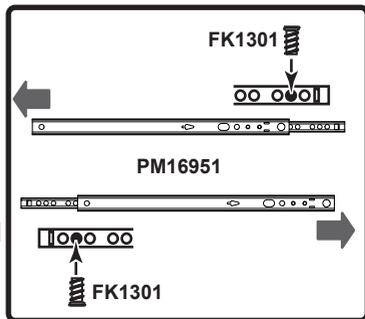

FK1301

PM16951

FK1301

2



PM16951 x 2

FK1309 x 1

FK1214 x 1

FK1301 x 4

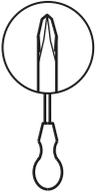

P2213
1903 x 480mm

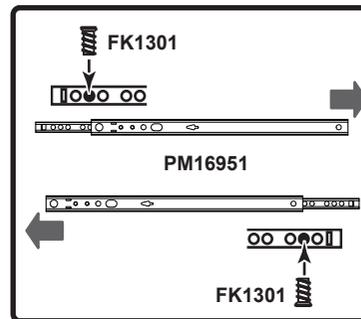

FK1301

PM16951

FK1301

PM16951

PM16951

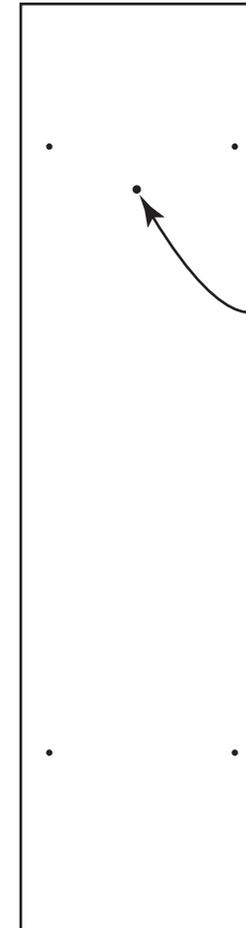
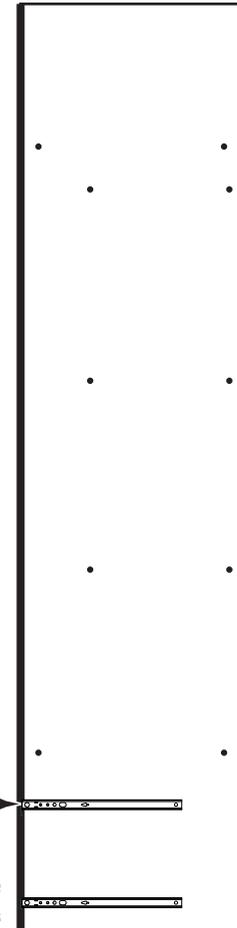

FK1214

FK1309

3



FK1013



FK1005 x 2



P1205
940 x 480mm

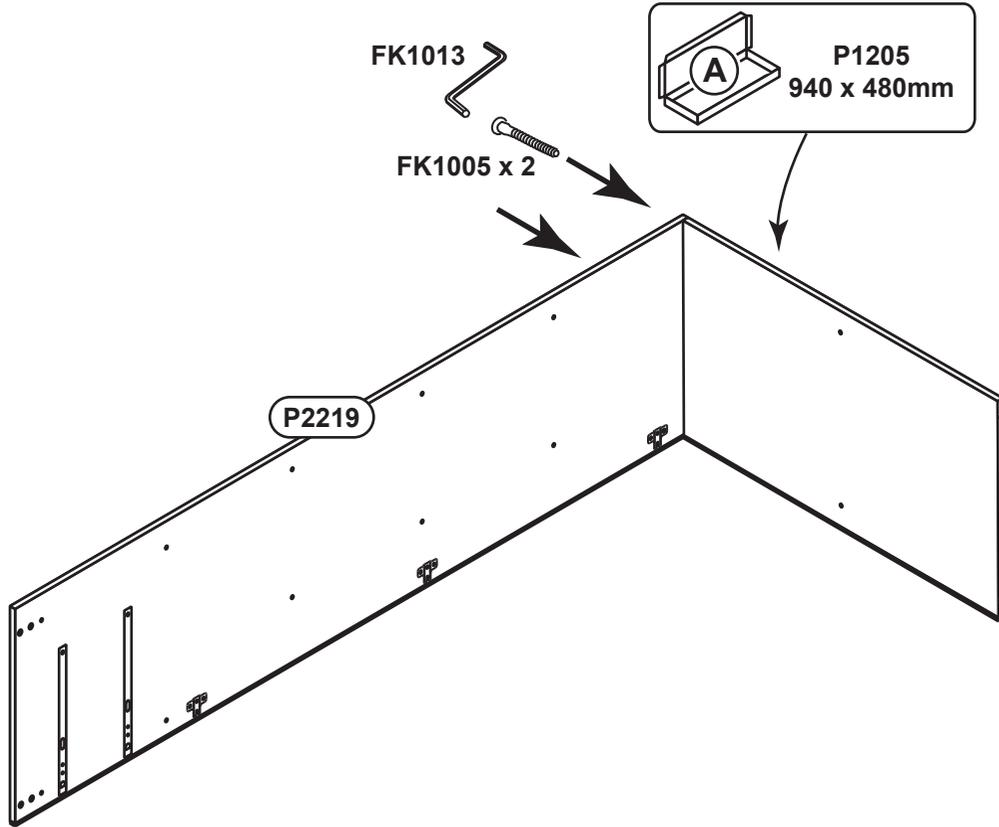

4

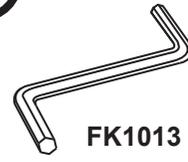

FK1013



FK1005 x 8



P1206B
462 x 480mm
x2

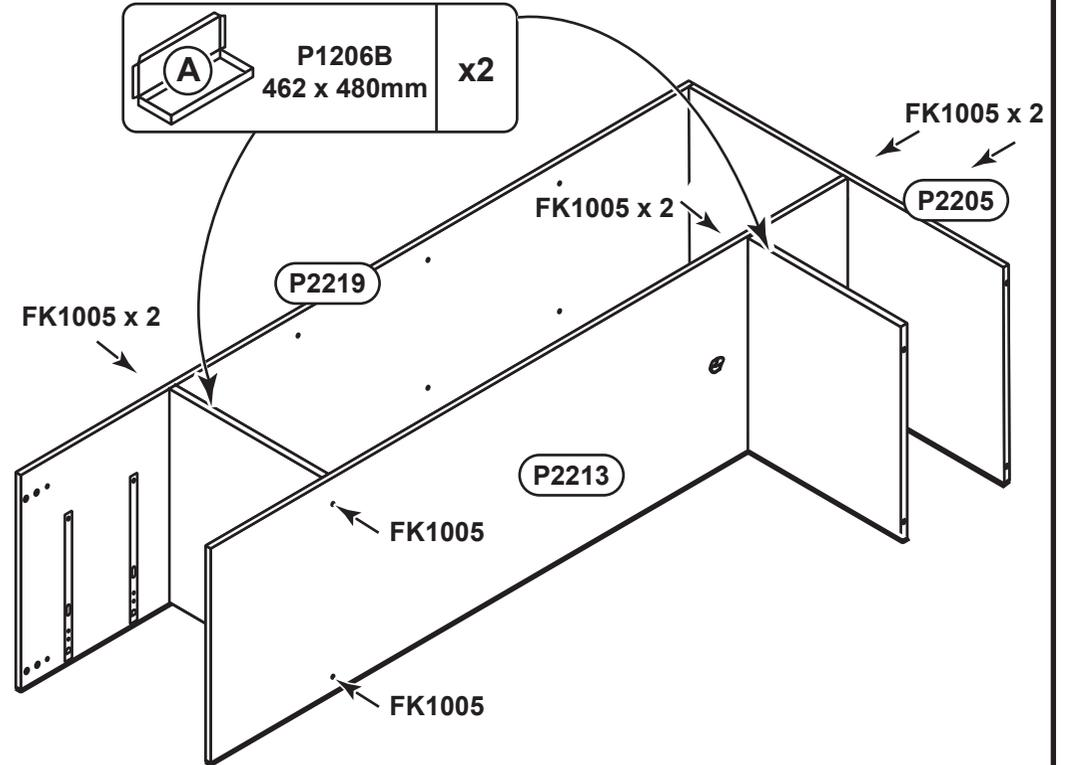

5



FK1013



FK1005 x 4

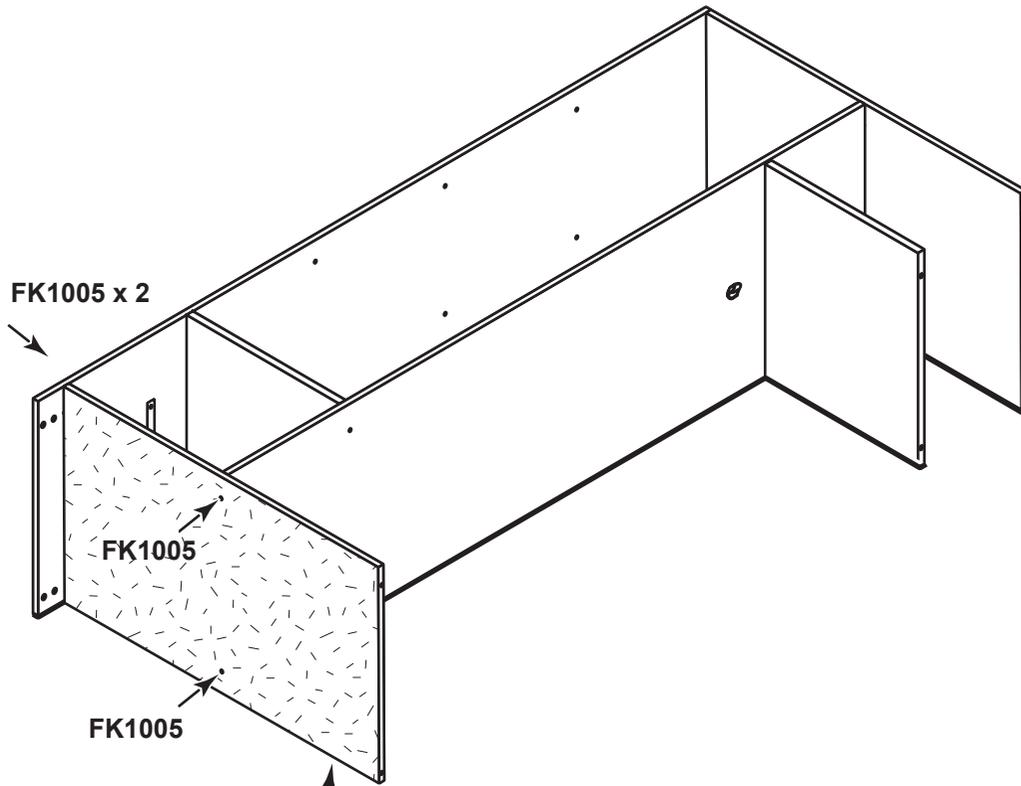

P1205
940 x 480mm

6



FK12641 x 3



FK1309 x 1



FK1214 x 1



P2208
2010 x 480mm

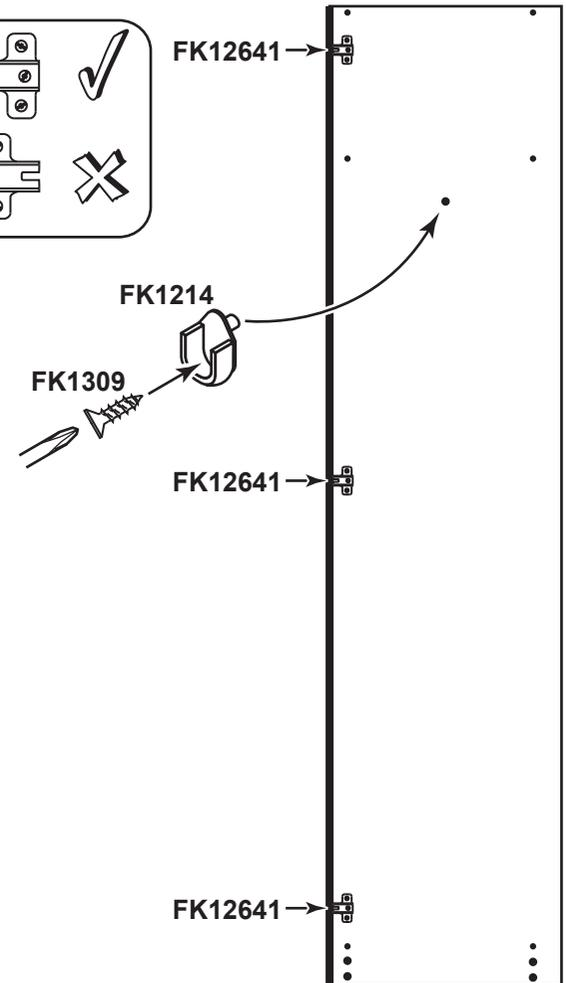
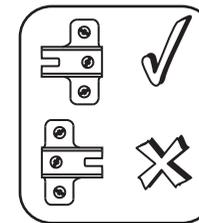

7

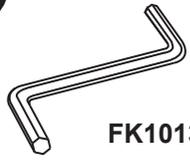

FK1013



FK1005 x 6



FK1411 x 8

FK1411 x 2

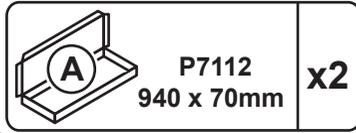

P7112

940 x 70mm

x2

FK1411 x 2

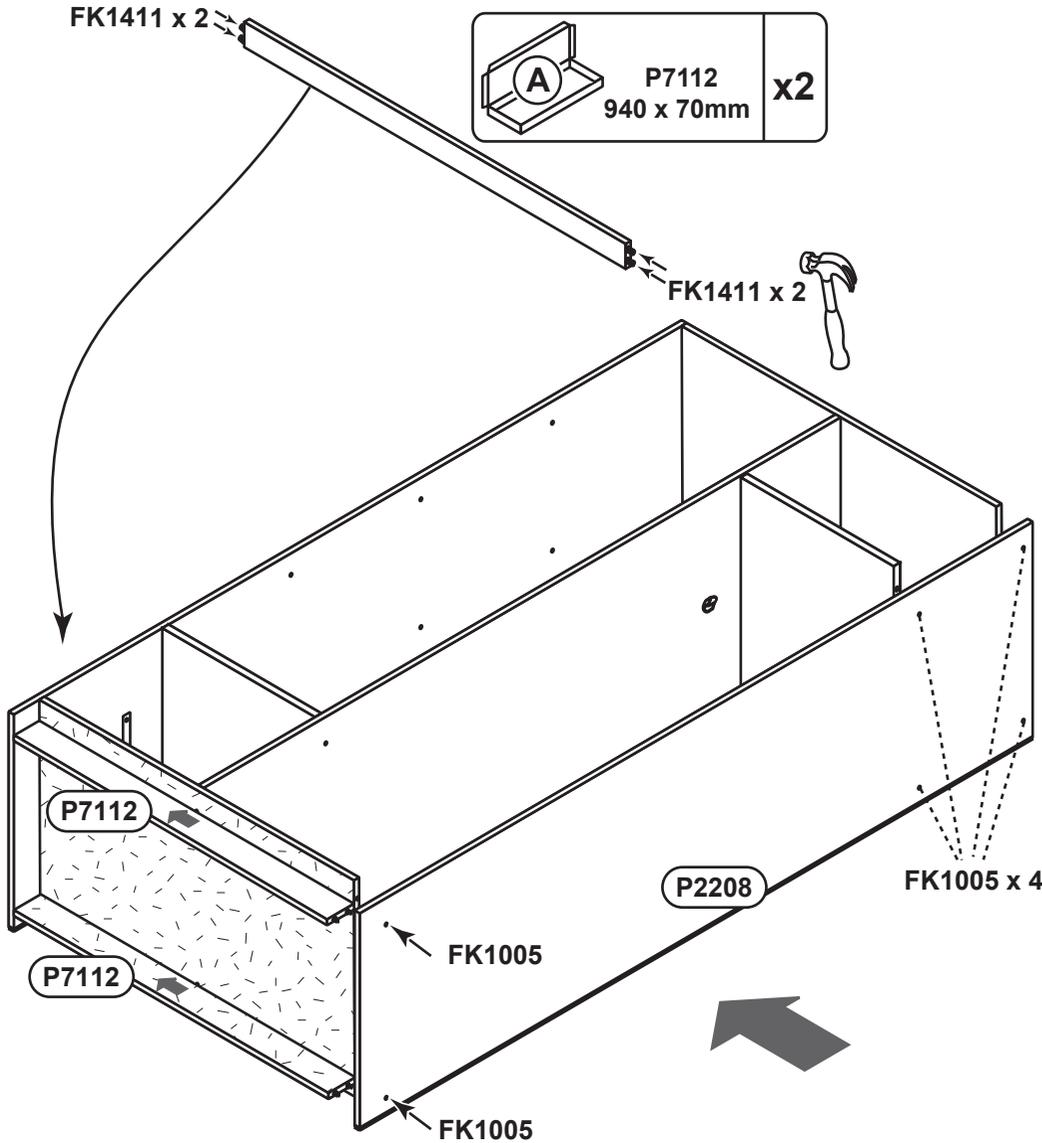

8



FK1515 x 60

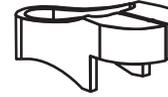

FK1415 x 1



FK1400 x 10

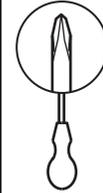

150mm

(6")

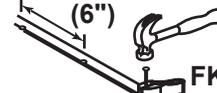

FK1415



A:A = B:B

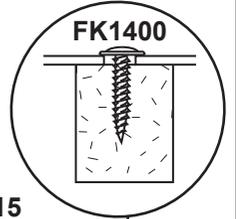

FK1400

A

FK1515

B

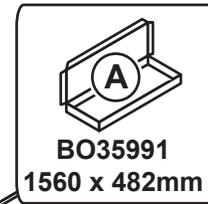

BO35991

1560 x 482mm

FK1400 x 10

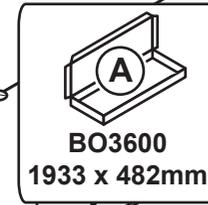

BO3600

1933 x 482mm

A

B

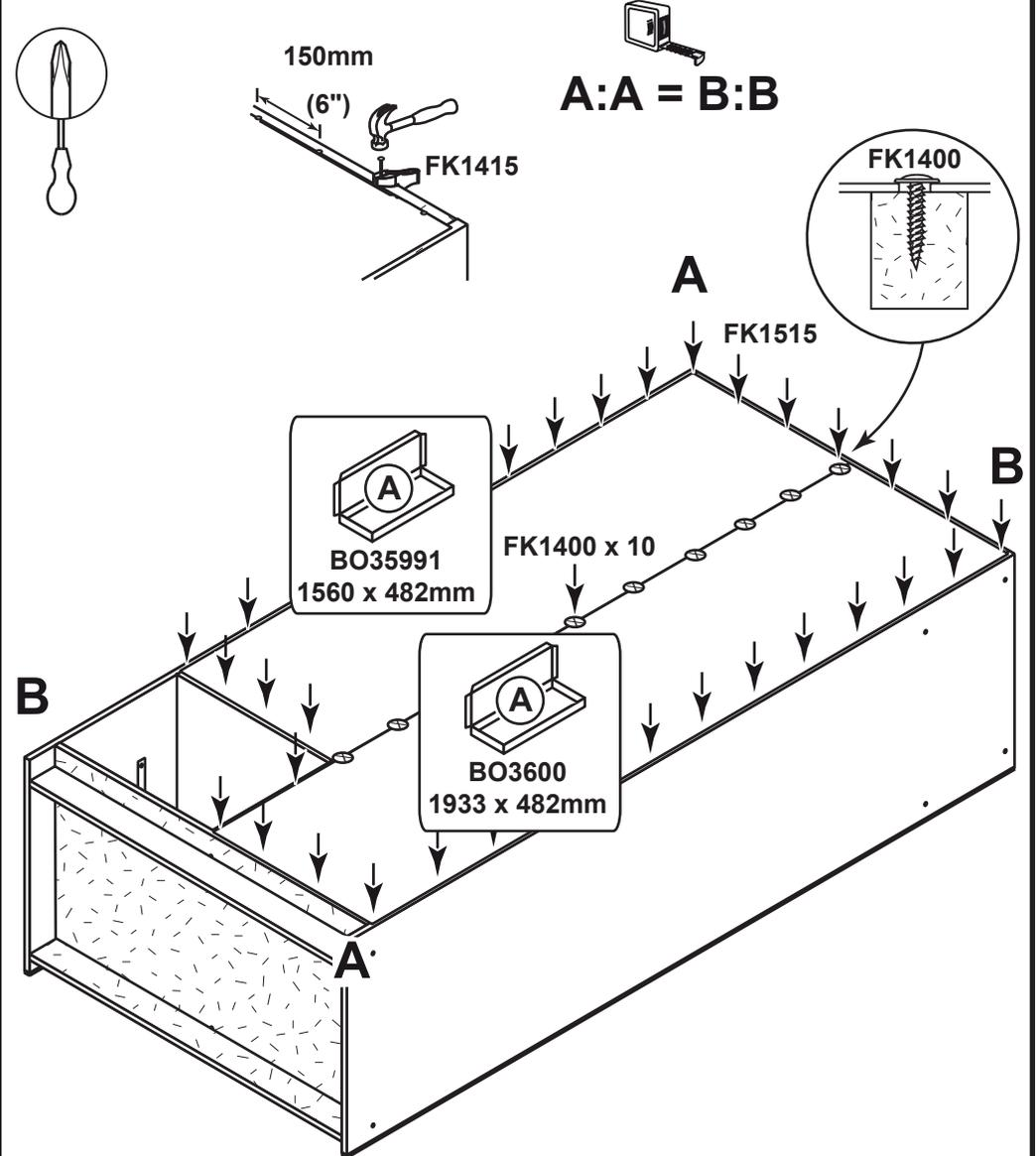

9

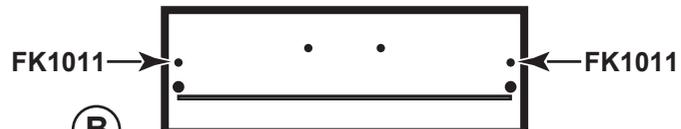

B

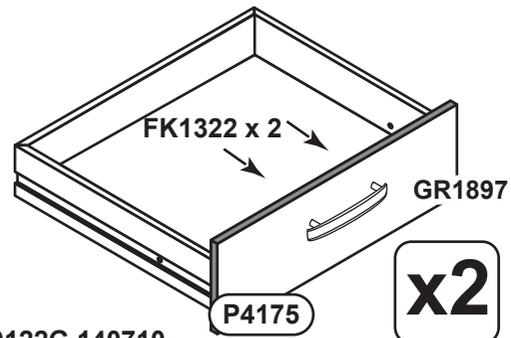
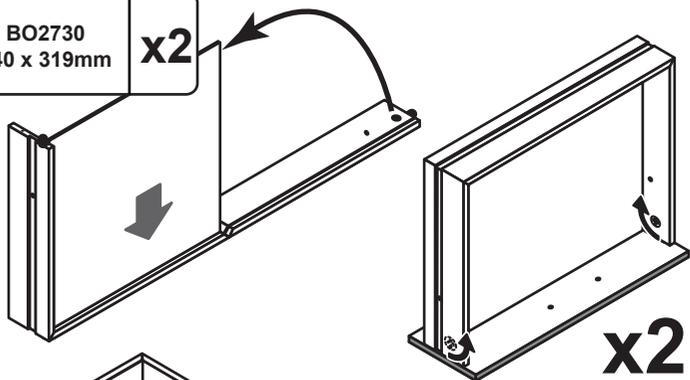
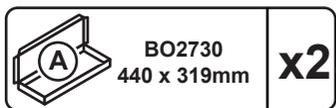
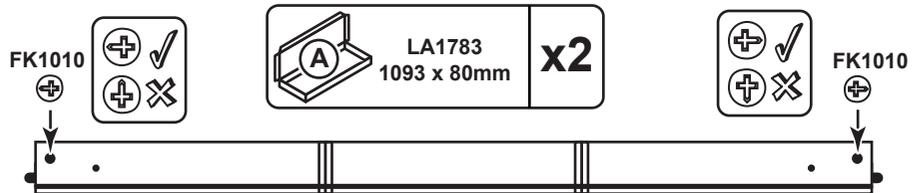

N190122G 140710

10

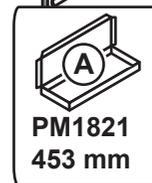
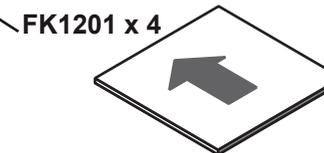
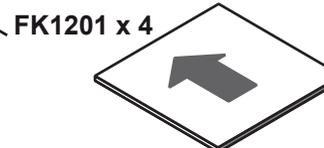
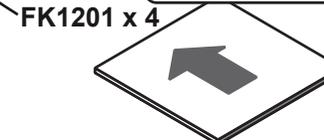
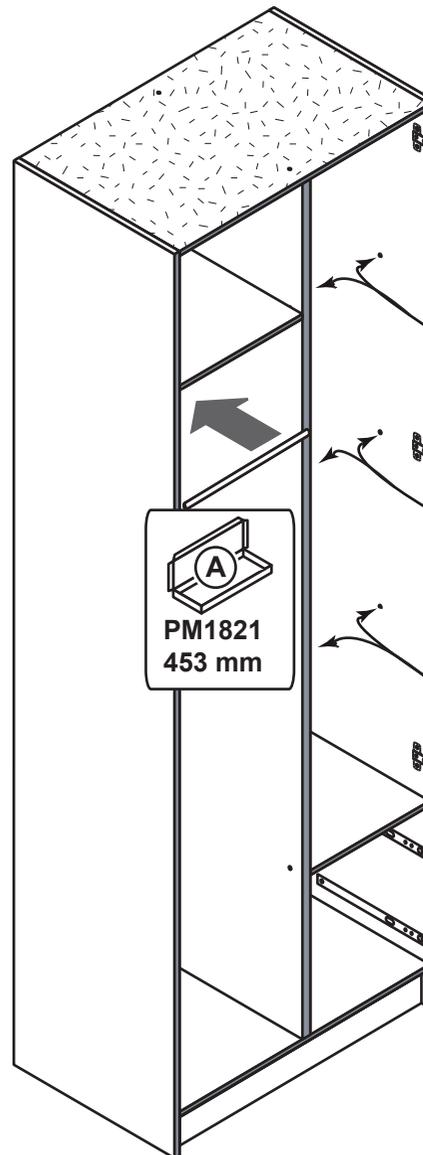

11



FK1981 x 4

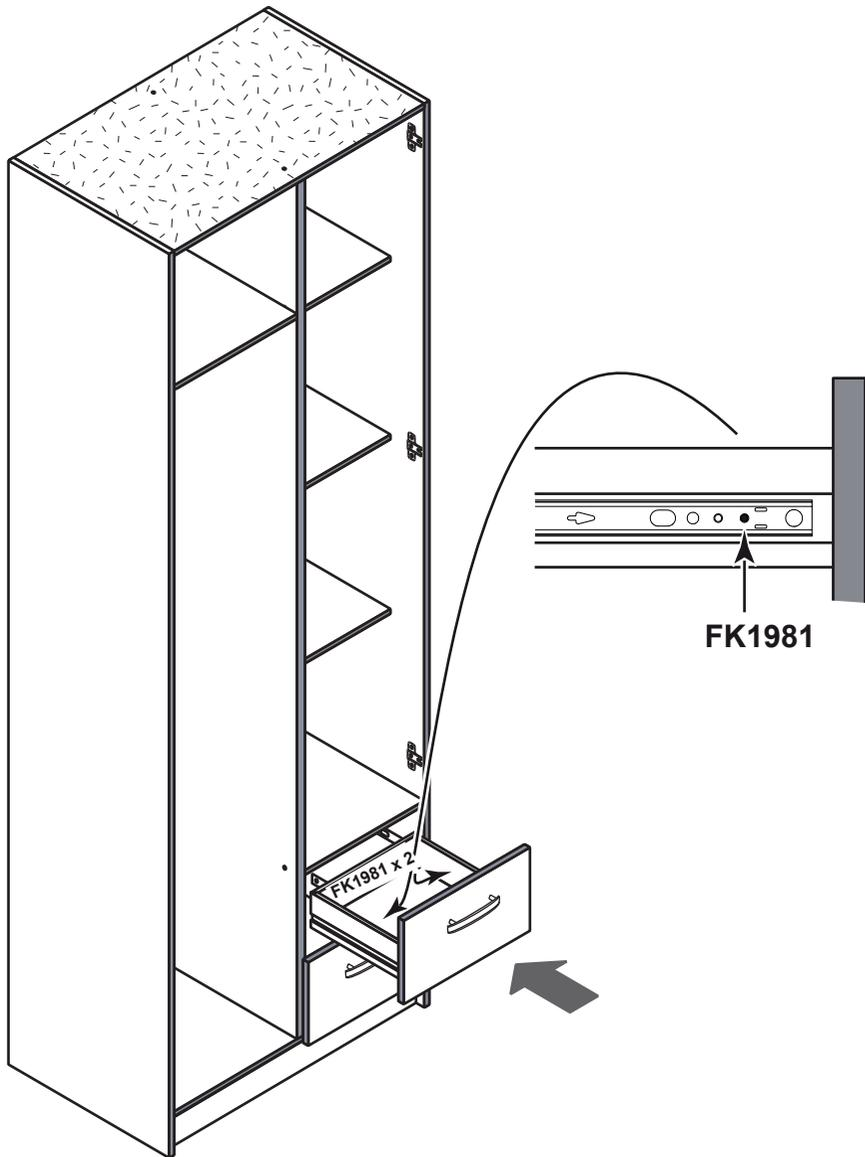

12



FK1309 x 12

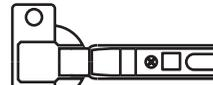

FK12541 x 6



P3205
1940 x 476mm



P3204
1556 x 476mm

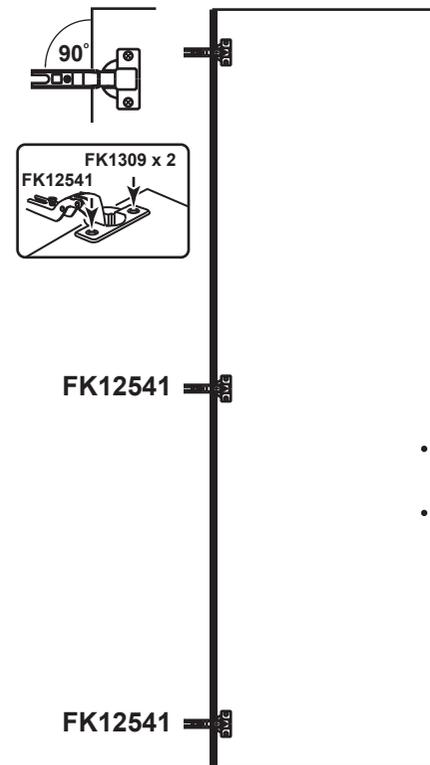
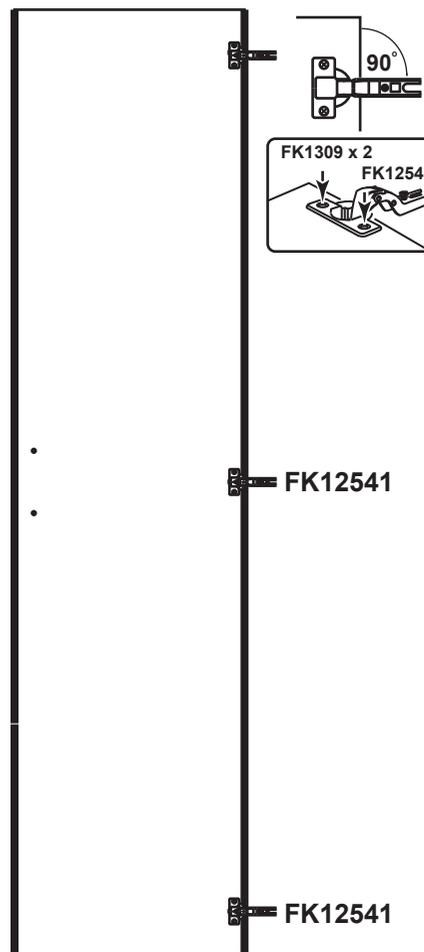

13



GR1897 x 2



FK1322 x 4

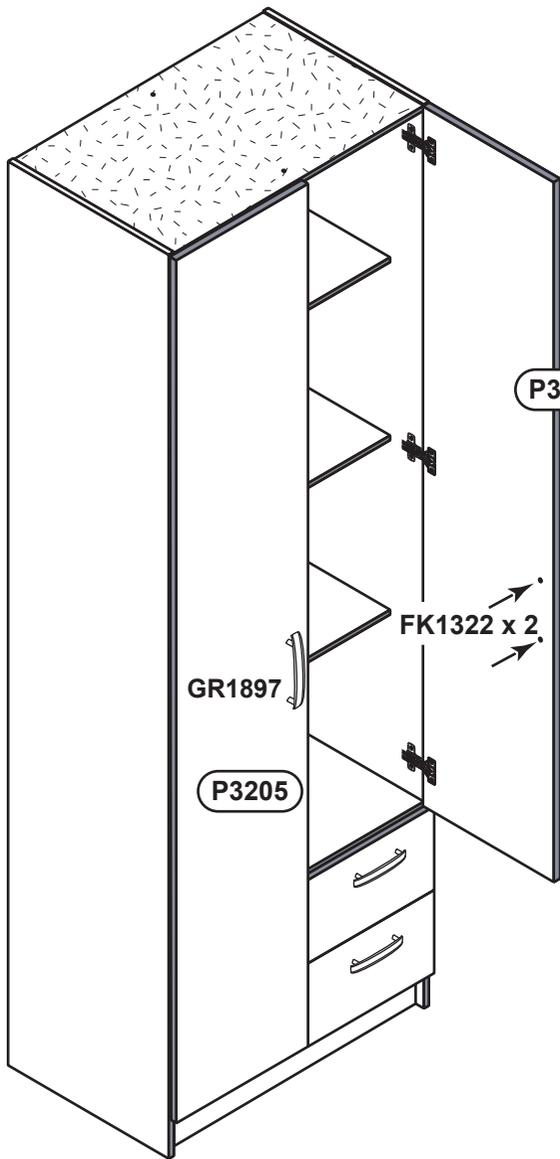
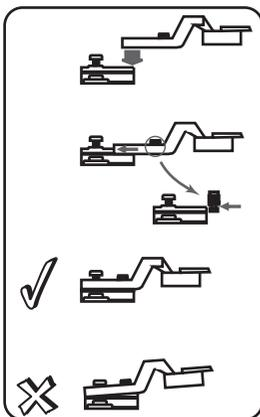

P3204

GR1897

FK1322 x 2

GR1897

P3205

14



FK1235 x 1



FK1400 x 1

