

**K'NEX**  
Building Worlds Kids Love

**52**

**MODEL  
BUILDING SET**  
**MODÈLE  
JEU DE  
CONSTRUCTION**

**1 MODÈLE PAR SEMAINE!**  
**1 MODEL PER WEEK!**

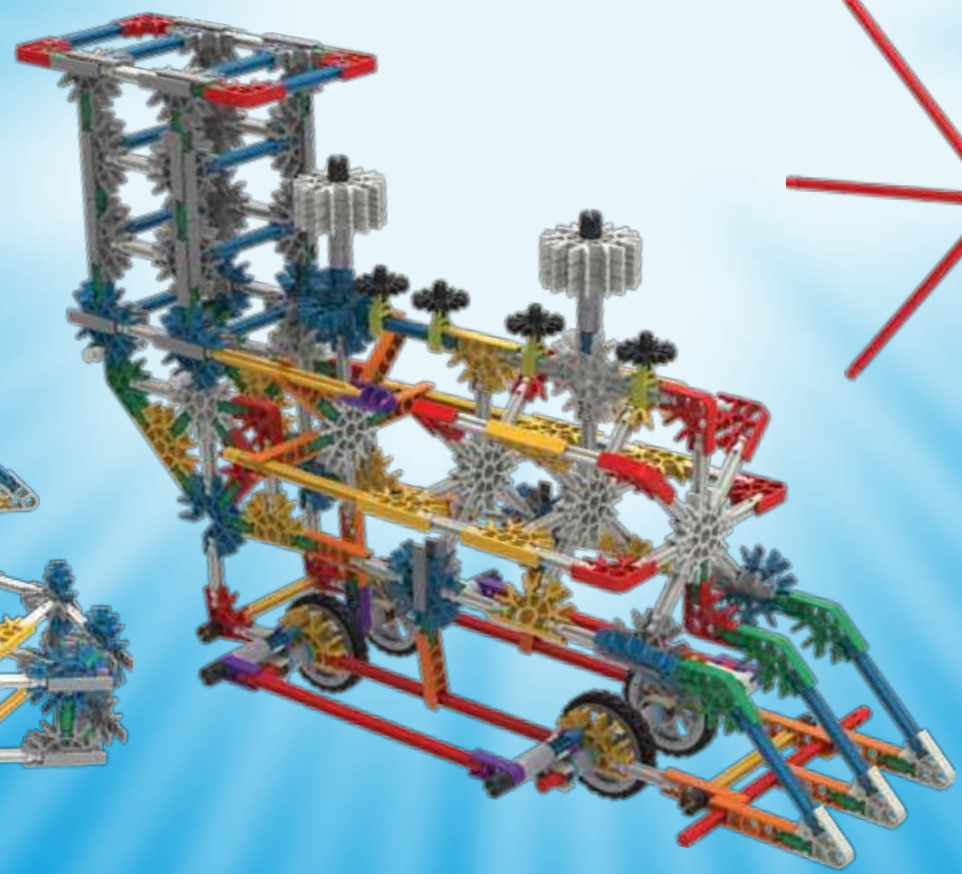
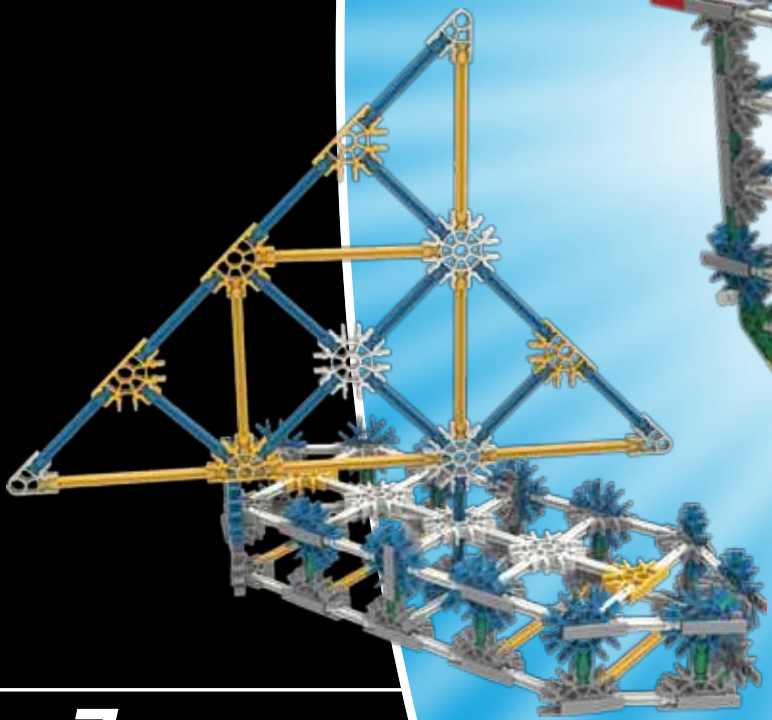

**7+** 13465

**AMERICA'S  
BUILDING TOY**  
**JOUET DE CONSTRUCTION  
d'AMERIQUE**

# CONTENTS

Hummingbird.....	6	Golf Cart .....	10
Camel.....	6	Sailboat.....	12
Praying Mantis.....	7	Skyscraper.....	13
Centipede .....	7	Dinosaur .....	14
Windmill .....	8	Steamroller.....	16
Butterfly.....	9	Bomber.....	20

## AMERICAN MADE PARTS

### Parts List

Before you start building, be sure to compare the parts in your set with the parts list here. If anything is missing, call or write to us using the information on the back cover. We are here to help you!

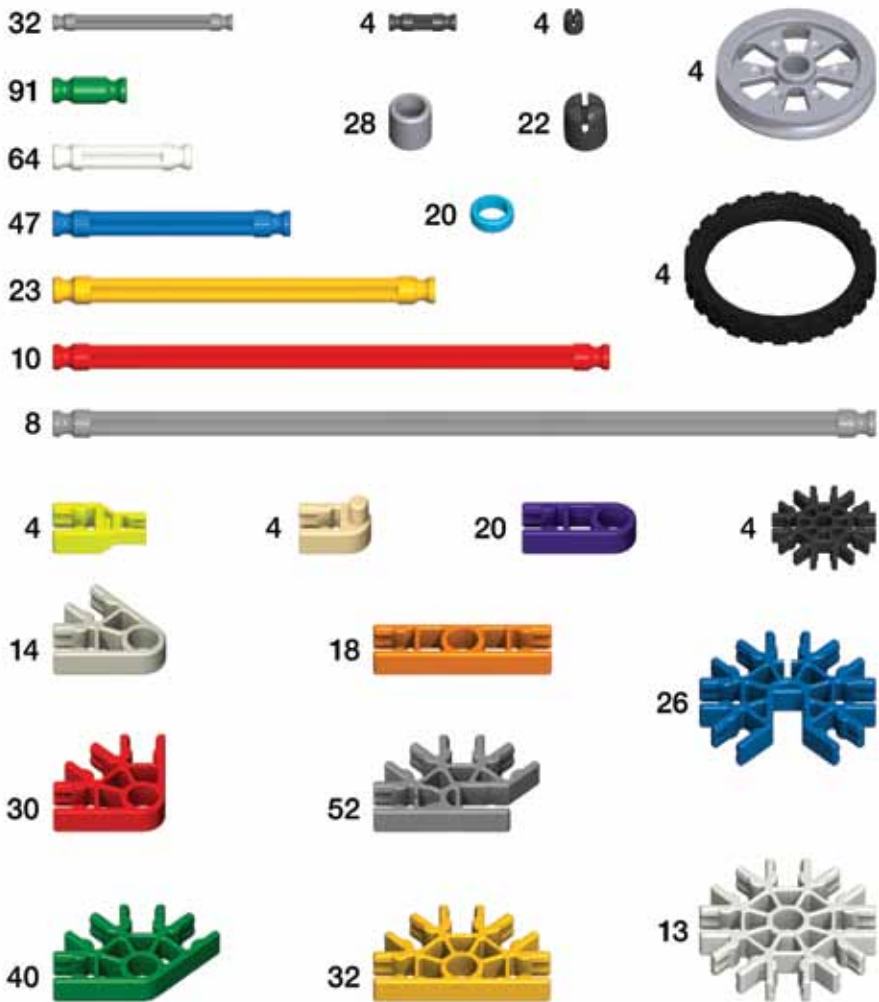

# K'NEX Building Basics

## Start Building

To begin your model, find the **1** and follow the numbers. Each piece has its own shape and color. Just look at the pictures, find the pieces in your set that match and then connect them together. Try to face your model in the same direction as the instructions while you build. The arrows show you where the parts connect, but not all connections points have arrows. Faded colors show you this section is already built.

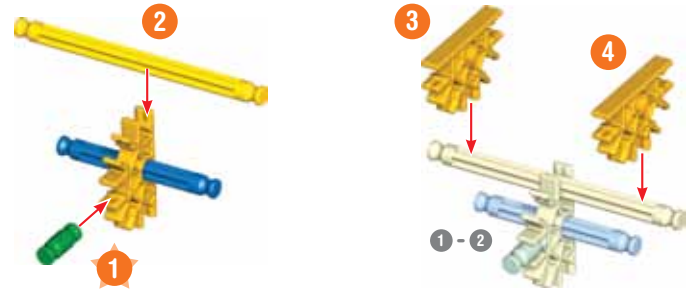

## Spacers

There are places in your model where you need to use spacers. Be sure to use the correct number of spacers shown in the instructions.



## Connectors

You can slide these special connectors together. Push tightly until you hear a "click". Pay close attention to the instructions and position them horizontally or vertically exactly as they are shown.

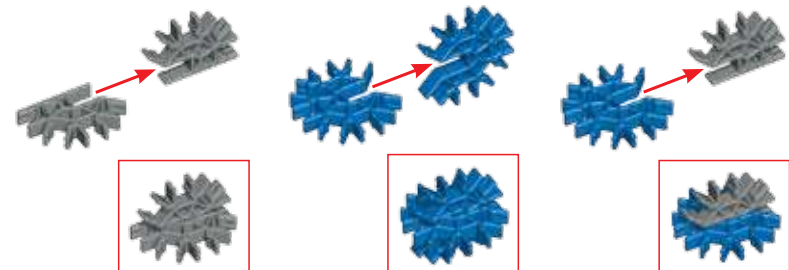

## CONTENUS

Colibri .....	6	Chariot de Golf.....	10
Chameau .....	6	Voilier.....	12
Mante de Prière.....	7	Gratte-ciel.....	13
Centipède .....	7	Dinosaure .....	14
Moulin à Vent.....	8	Rouleau Compresseur..	16
Papillon.....	9	Bombardier .....	20

**FAIT AUX ÉTATS-UNIS**

### Liste des Pièces

Avant de commencer, s'assurer de comparer les pièces dans la boîte à la liste de pièces fournie ici. S'il manque quelque chose, nous téléphoner ou nous écrire en vous servant des informations figurant au verso de la notice. Nous sommes là pour vous aider !

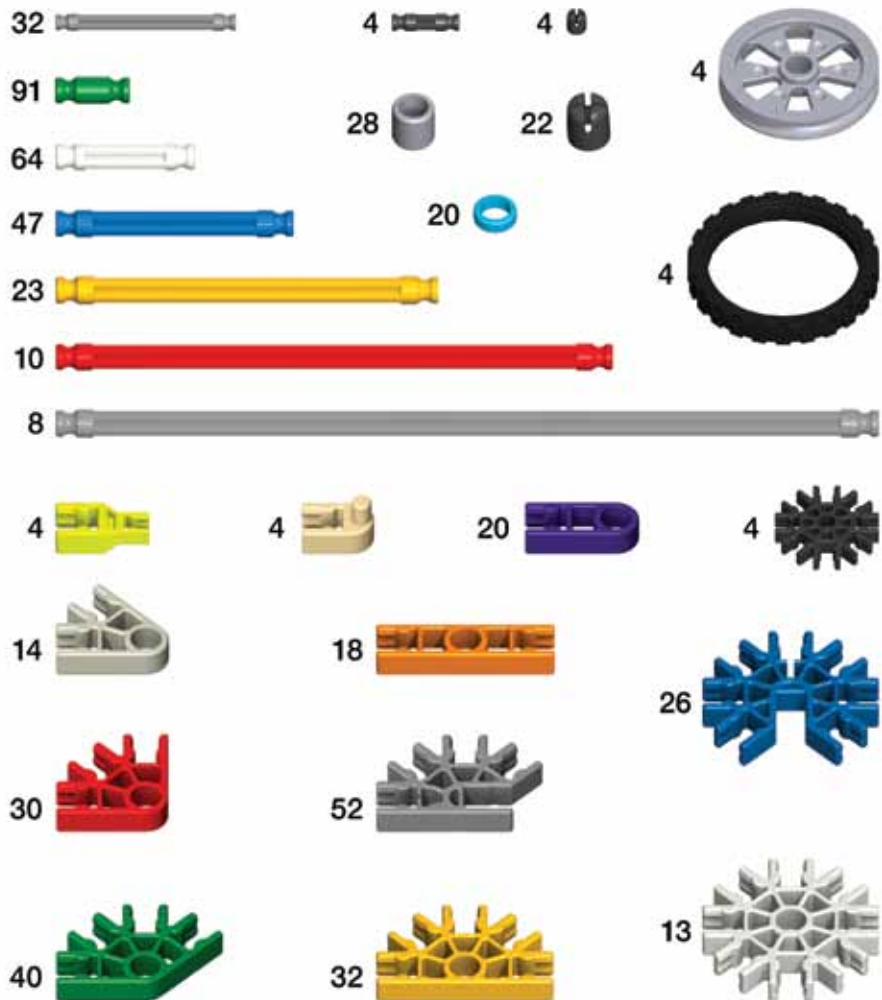

# Esenciales de construcción K'NEX

## Démarrer la Construction

Pour commencer le modèle, trouver l'étape numéro 1 trouver les numéros. Chaque pièce a sa propre forme et sa propre couleur. Regarder les illustrations, trouve les pièces qui correspondent à l'illustration et les assembler. Pour vous faciliter la tâche, orienter le modèle dans le même sens que les instructions. Les flèches indiquent où les pièces s'assemblent, mais les points de raccordement n'ont pas tous des flèches. Les pièces de couleur délavées sont celles déjà assemblées.

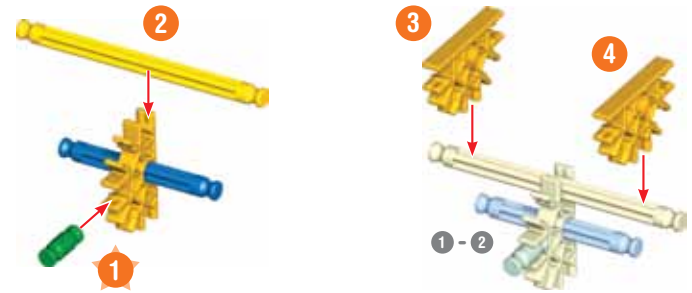

## Espaceurs

Il y a des endroits sur le modèle où des espaceurs sont nécessaires. S'assurer d'utiliser la bonne couleur et le nombre d'espaceurs indiqué sur les instructions.



## Connecteurs

Vous pouvez assembler ces connecteurs tout à fait uniques en les faisant glisser l'un dans l'autre. Pousser fort jusqu'au « clic ». Lire les instructions attentivement et les positionner horizontalement ou verticalement, en suivant exactement les illustrations.

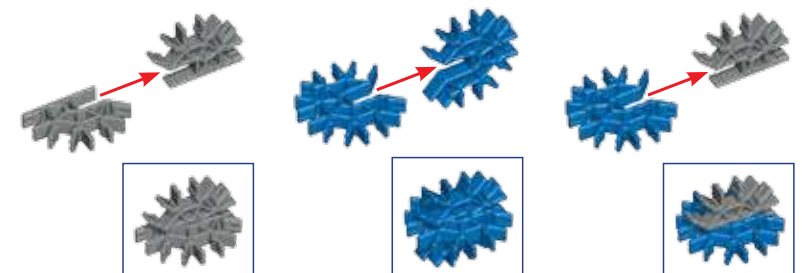

# 52 MODELS MODÈLES

1 PER WEEK!  
1 PAR SEMAINE!



For instructions of all these models go to [www.knex.com/instructions](http://www.knex.com/instructions) and enter code 13465.

Car les instructions de ces modèles vont à [www.knex.com/instructions](http://www.knex.com/instructions) et entrez dans le code 13465.



## Hummingbird Colibri

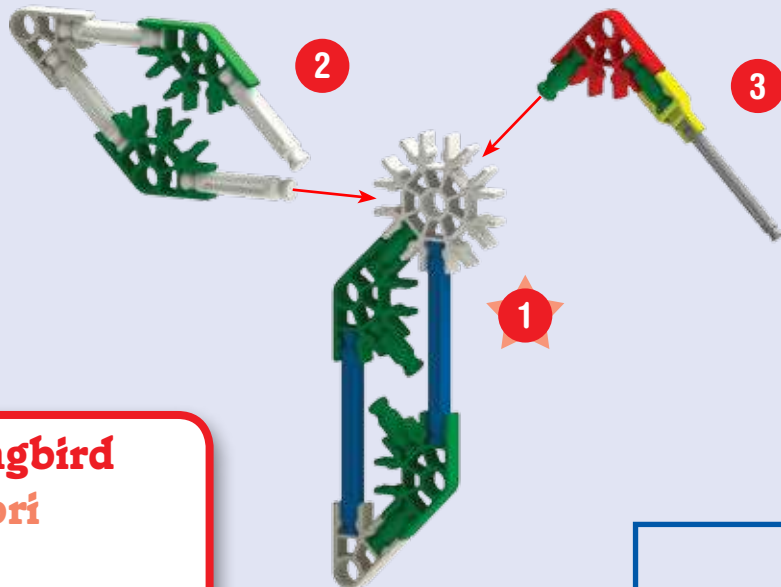

## Camel Chameau

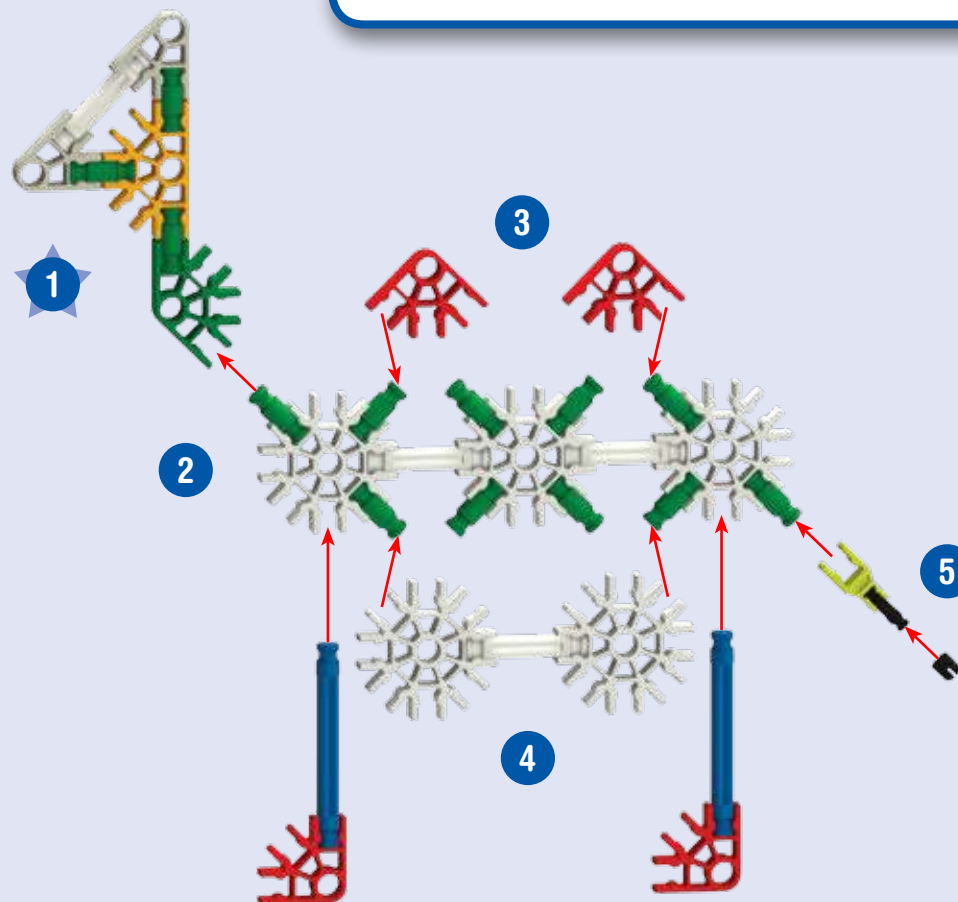
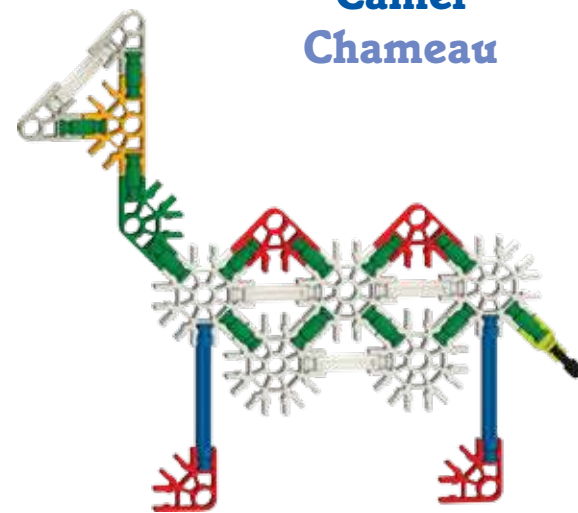

WARNING: CHOKING HAZARD – Small parts.  
Not for children under 3 years.

ATTENTION ! RISQUE D'ÉTOUFFEMENT – Petite taille.  
Ne convient pas aux enfants de moins de 3 ans.

ADVERTENCIA: PELIGRO DE ASFIXIA – Piezas pequeñas.  
No recomendado para niños menores de 3 años.

WARNUNG: ERSTICKUNGSGEFAHR – Kleinteile.  
Nicht für Kinder unter 3 Jahren.

AVVISO: PERICOLO DI SOFFOCARE – Pezzi piccoli.  
Non adatto per bambini sotto 3 anni.

AVISO: PERIGO DE SUFOCAÇÃO – Peças pequenas.  
Não indicado para crianças menores de 3 anos.

WAARSCHUWING: VERSTIKKINGSGEVAAR – KLEINE  
ONDERDELEN. Niet voor kinderen onder 3 jaar.

**Praying Mantis**  
**Mante de Prière**

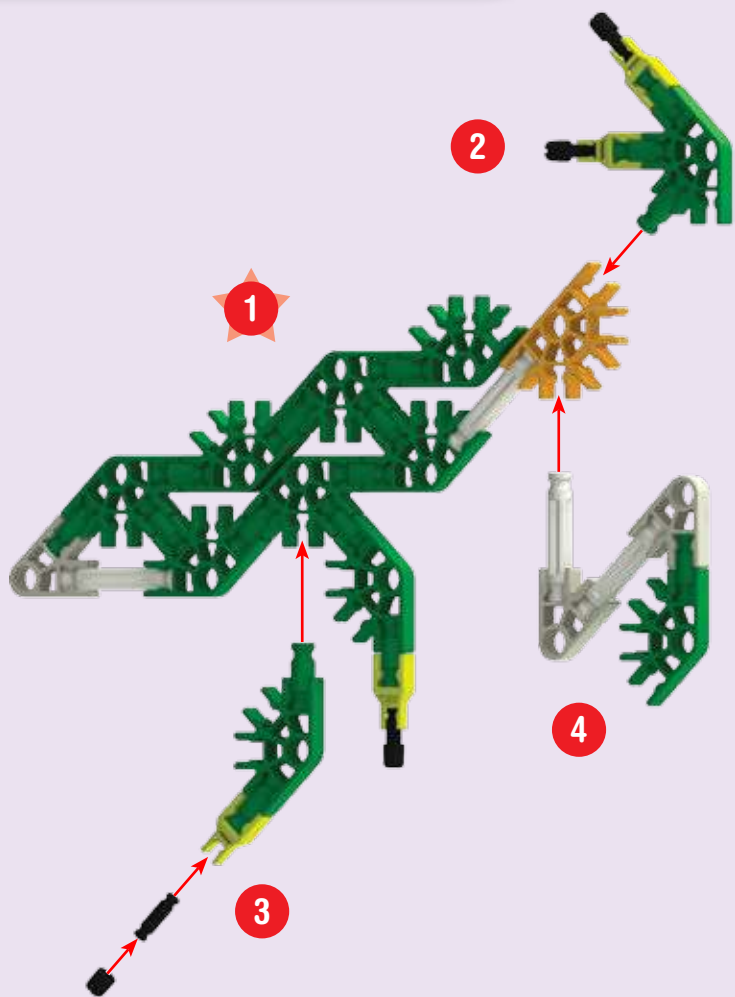

**Centipede**  
**Centipède**

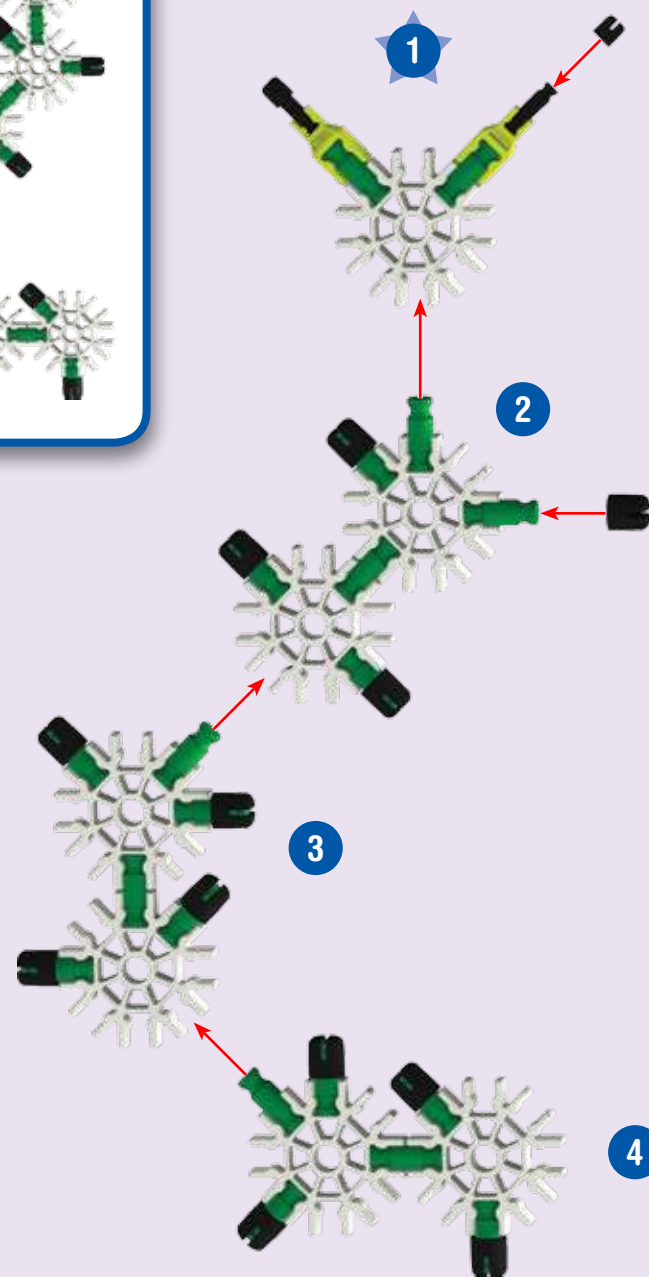
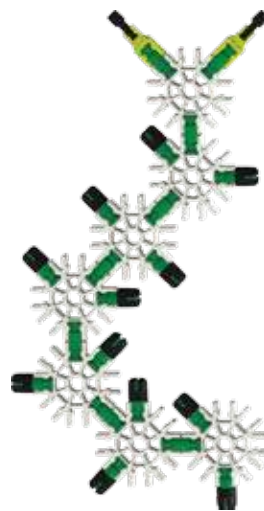

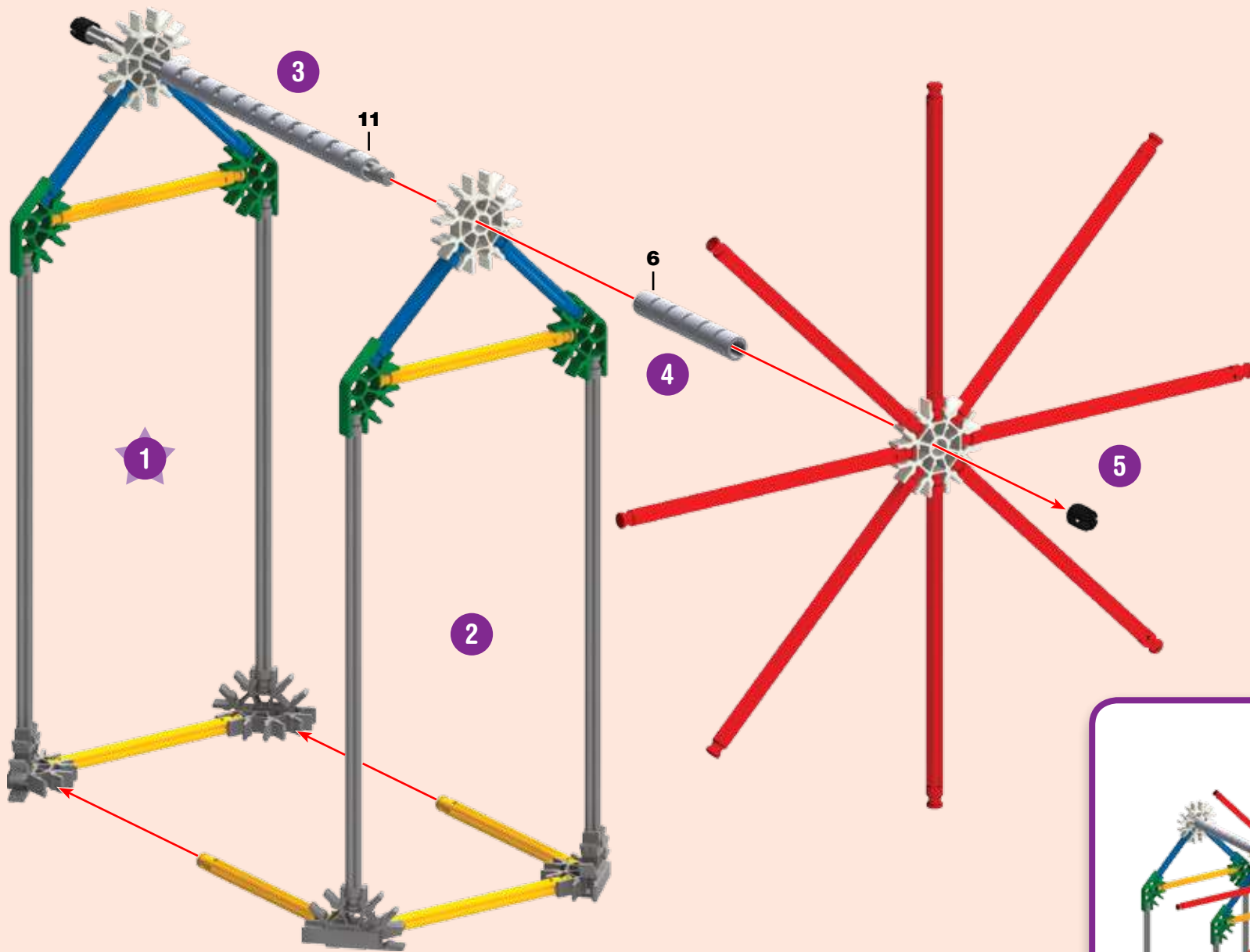

CAUTION: Use care where you use these models. Models could damage furniture or walls, or injure people or pets.

ATTENTION : Utilisez des soins là où vous utilisez ce modèles. Modèles pourrait endommager les meubles ou les murs, ou

blessar des personnes ou des animaux domestiques.

PRECAUCIÓN: Tenga mucho cuidado cuando se utiliza este modelos. Modelos podría dañar los muebles o las paredes, o lesionar a personas o animales.



**Windmill**  
**Moulin à**  
**Vent**





**Butterfly  
Papillon**

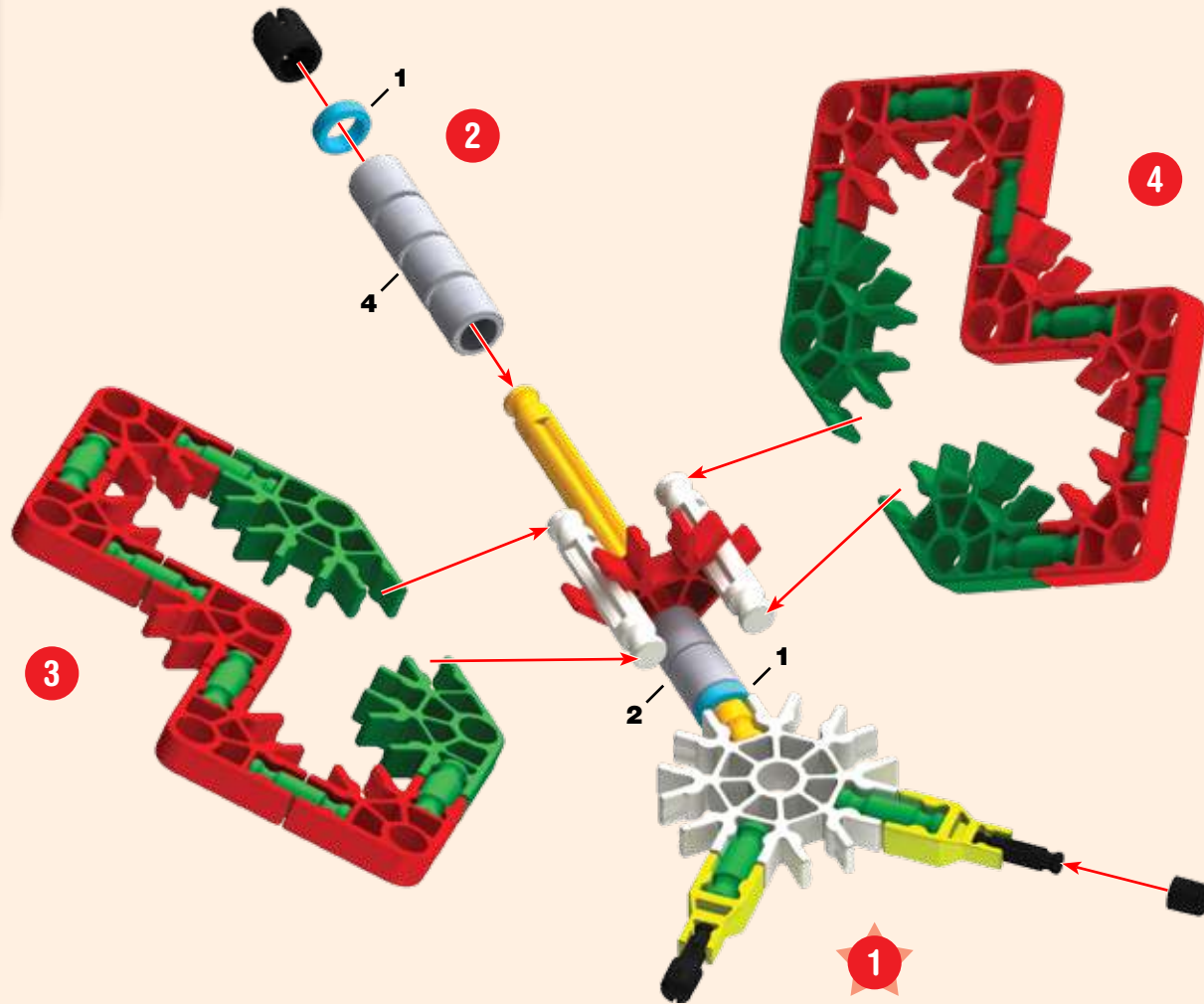

# Golf Cart Chariot de Golf

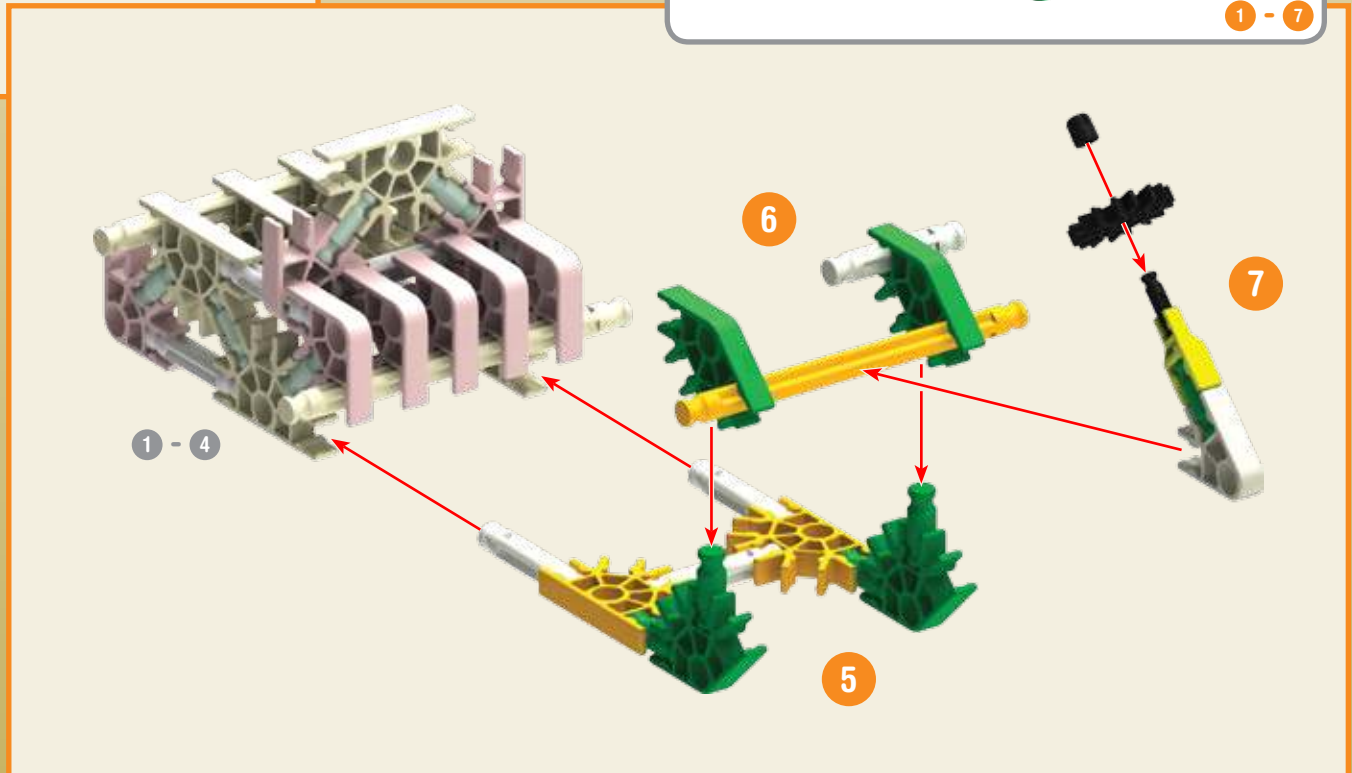
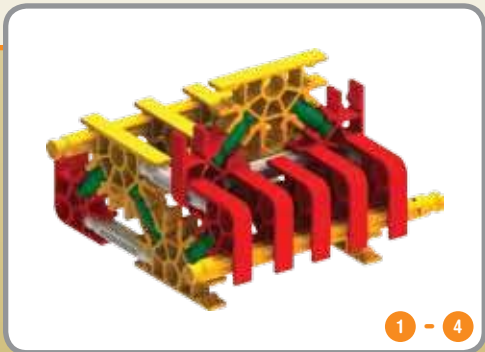
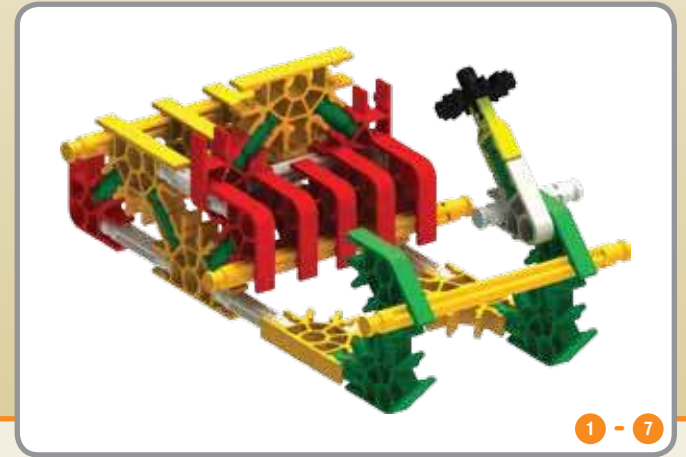
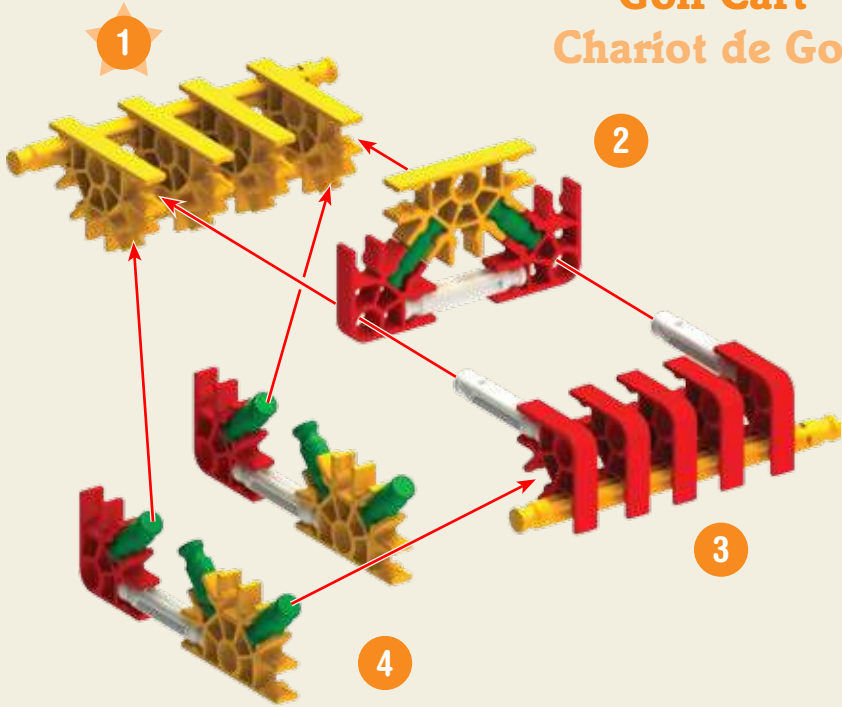

# Golf Cart Chariot de Golf

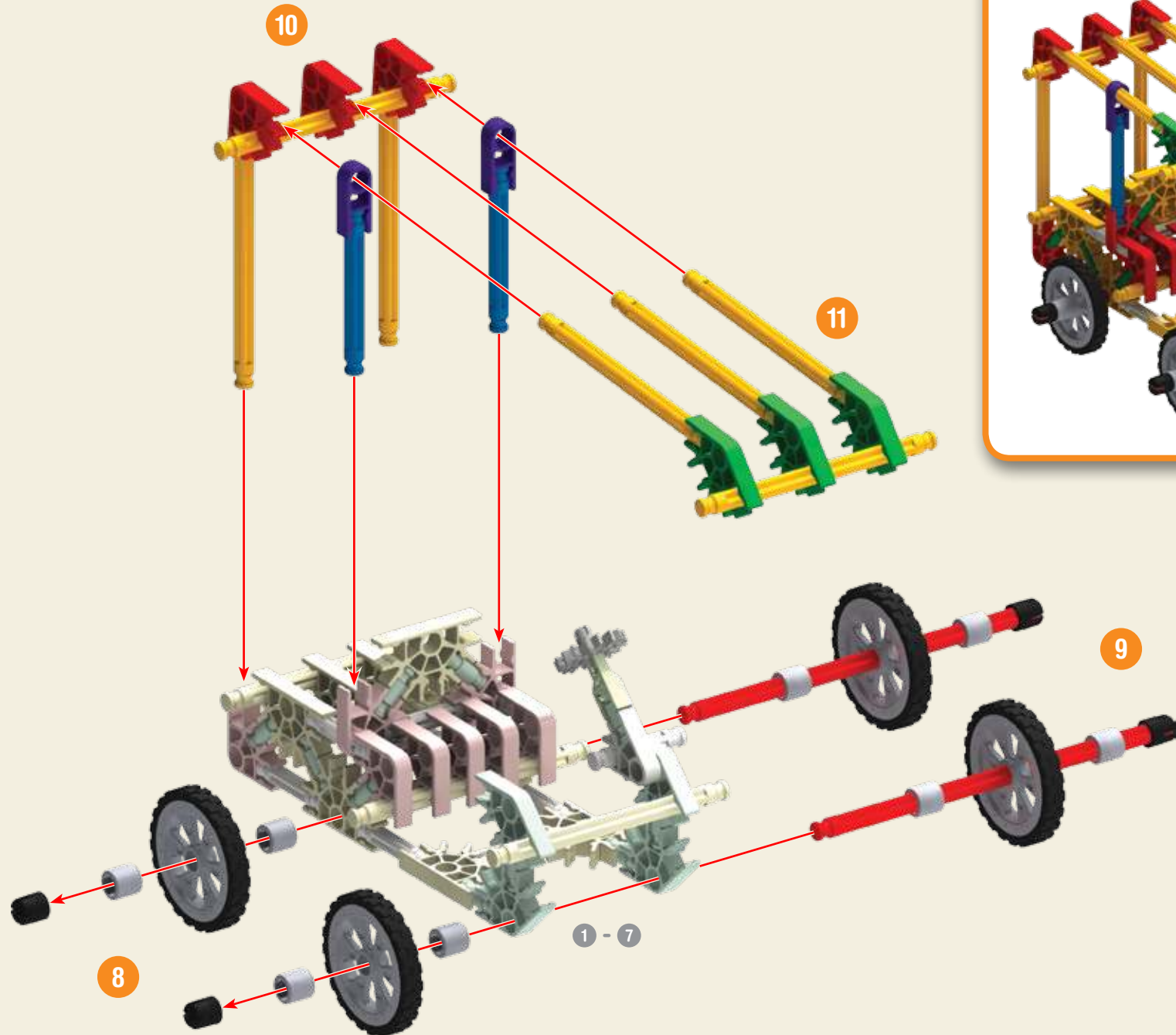

# Sailboat Voilier

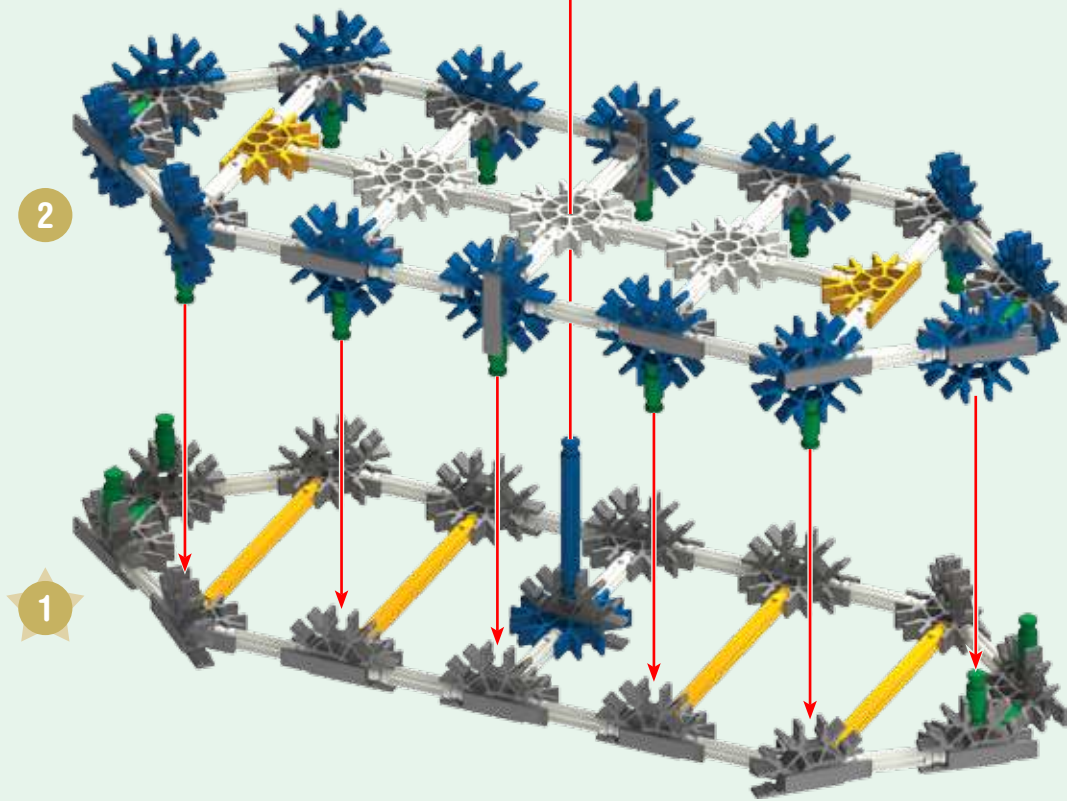
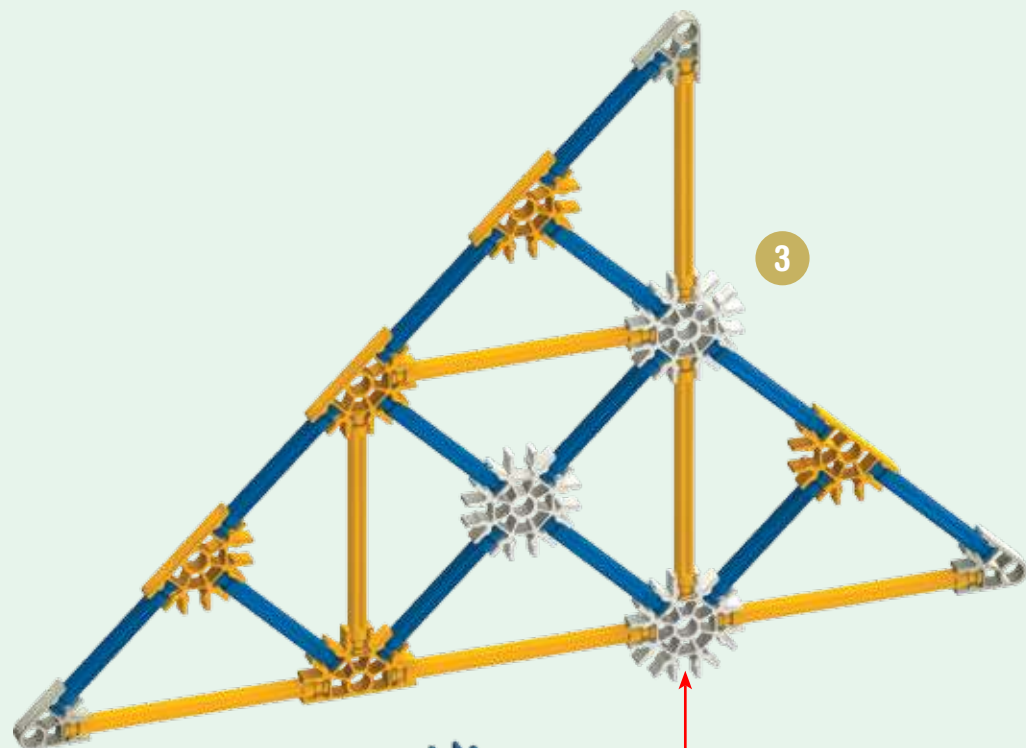

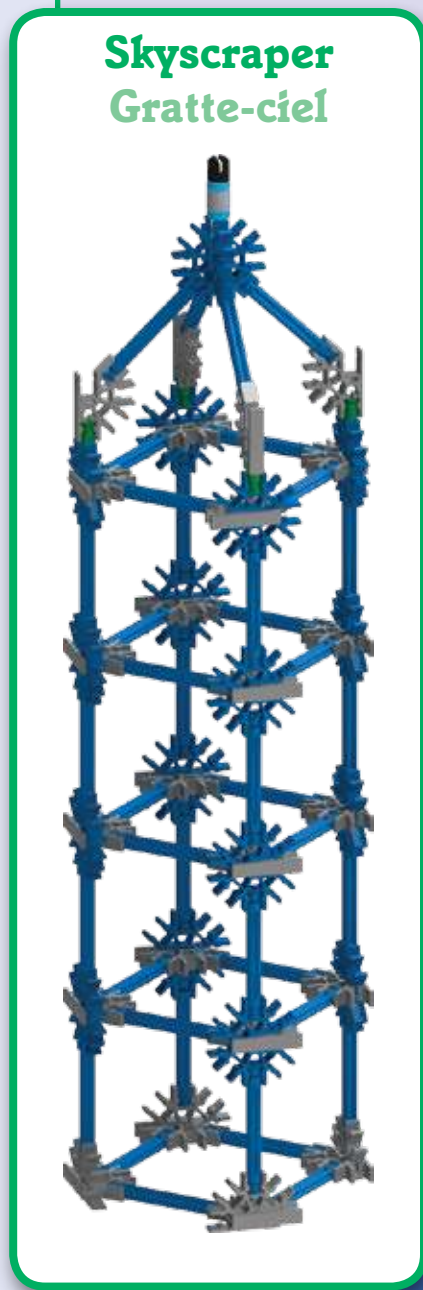
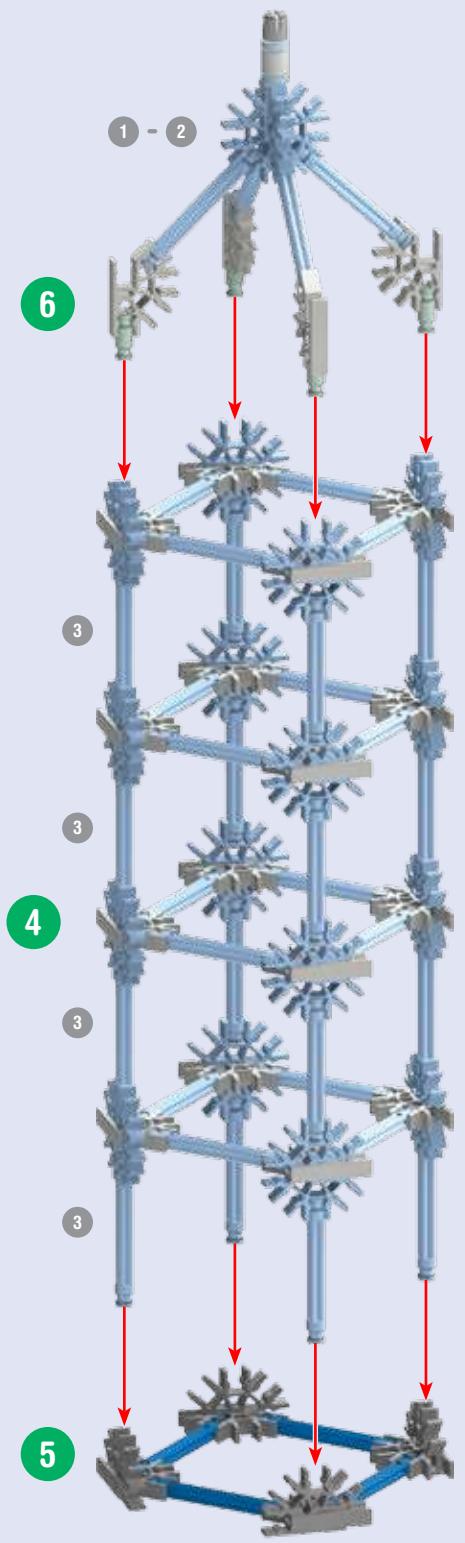
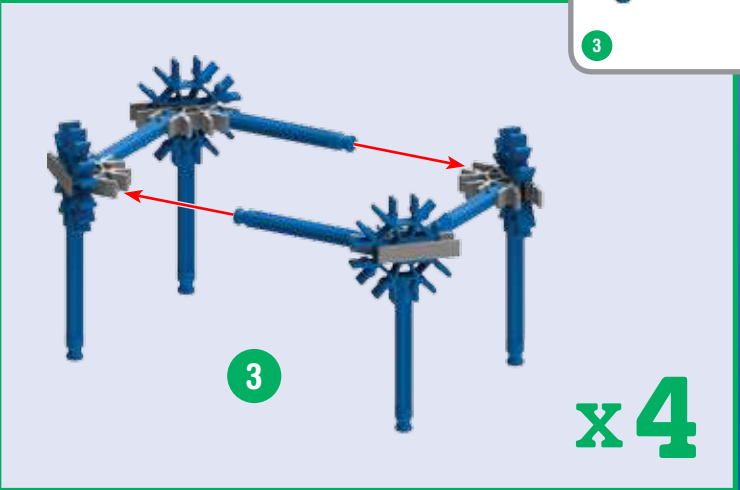
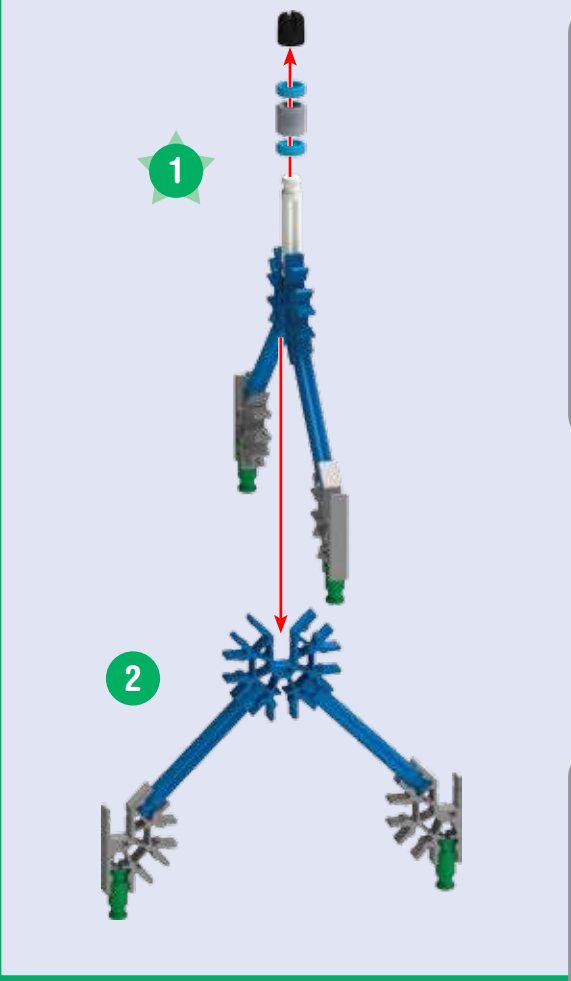

# Dinosaur Dinosaure

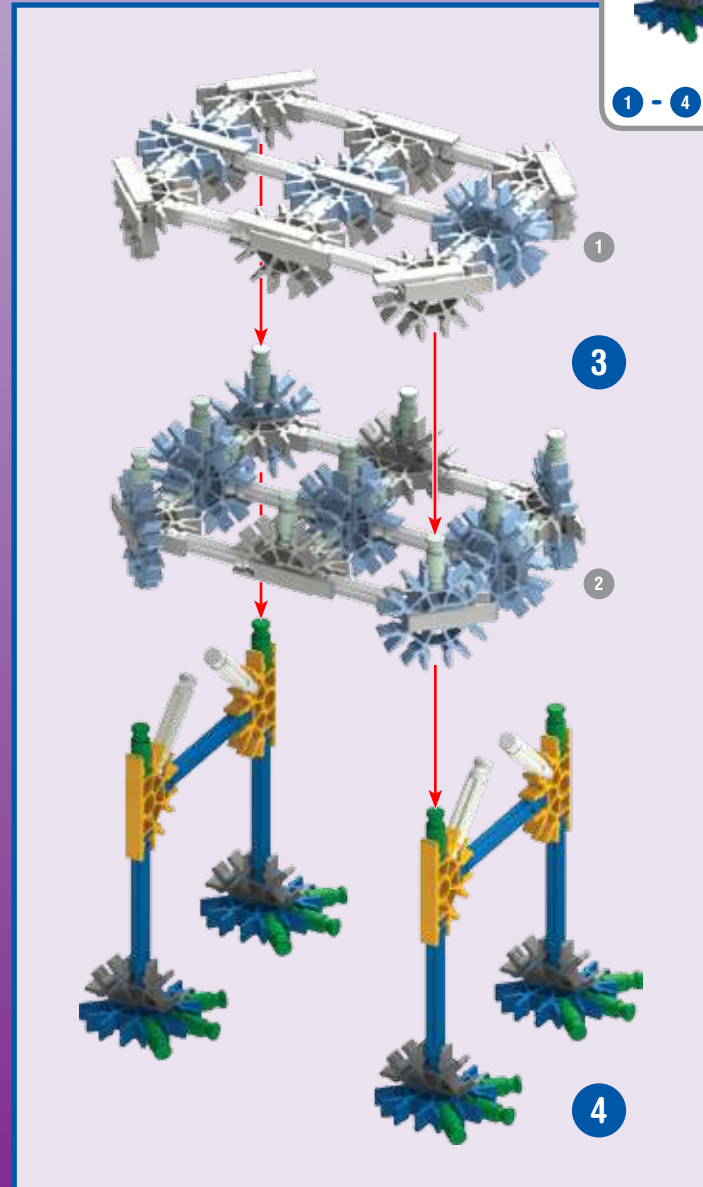
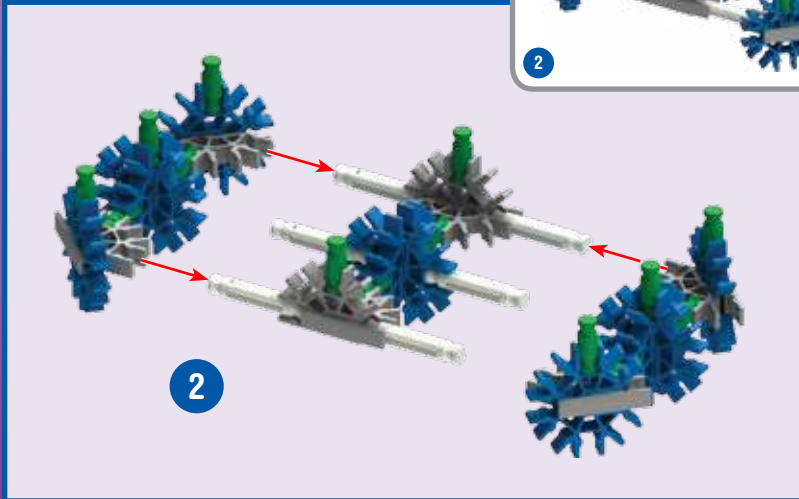
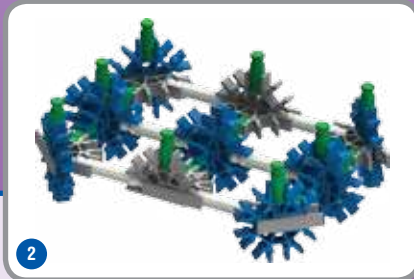
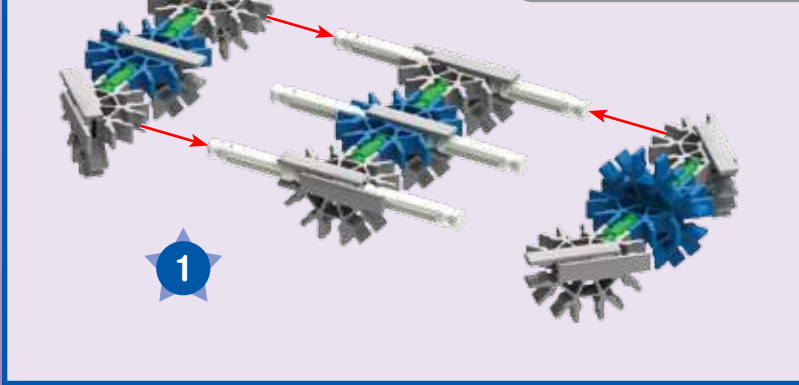
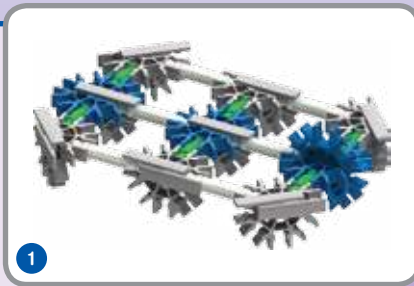

Dinosaur  
Dinosaure

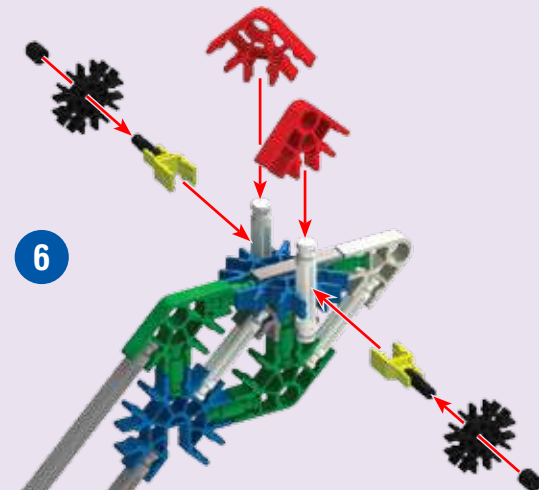

5

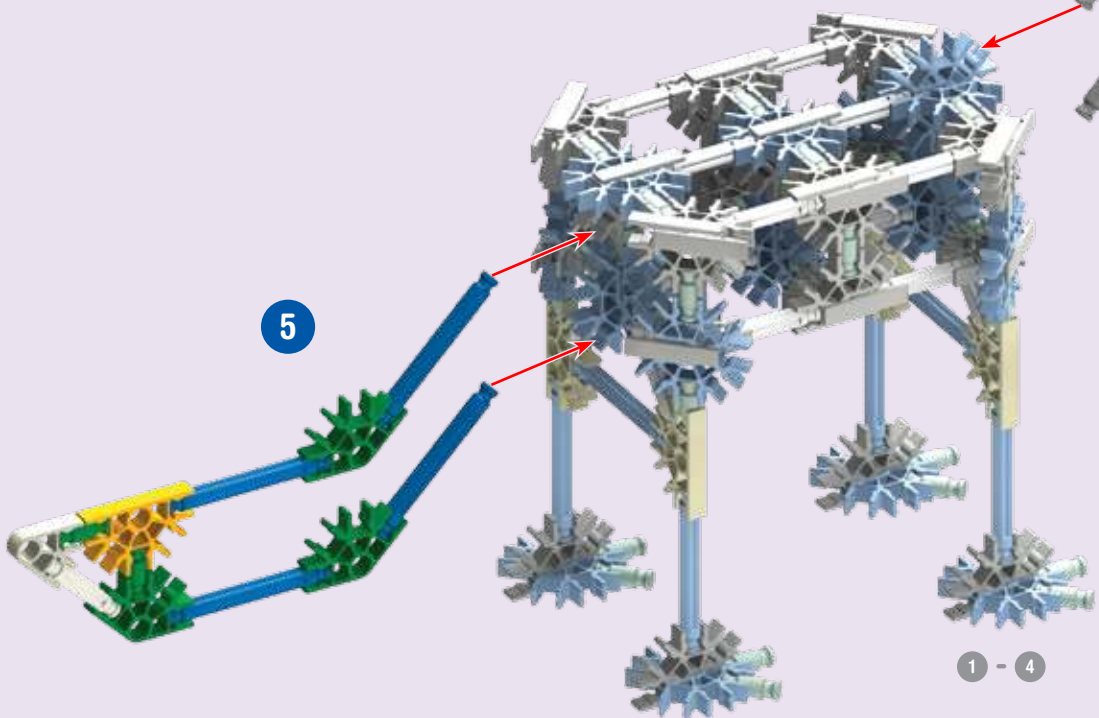

# Steamroller Rouleau Compresseur

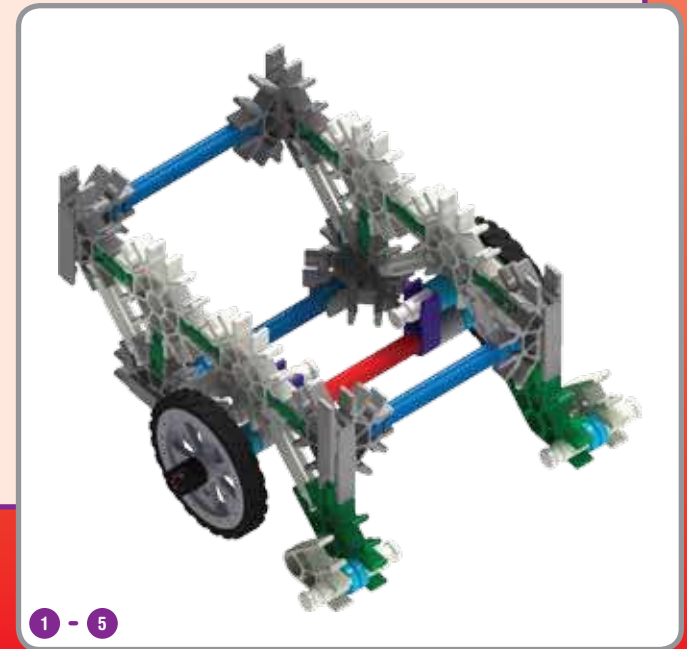
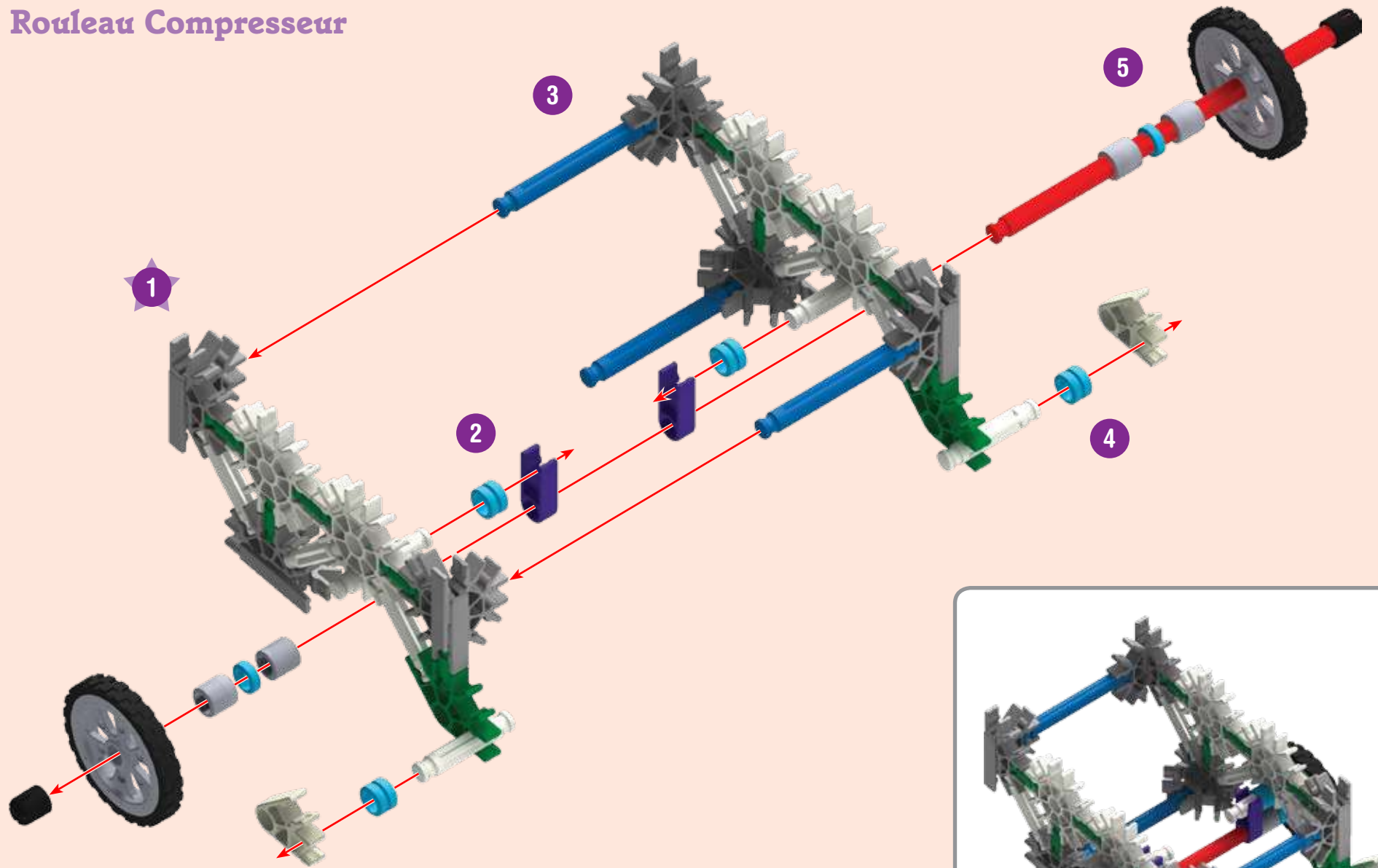



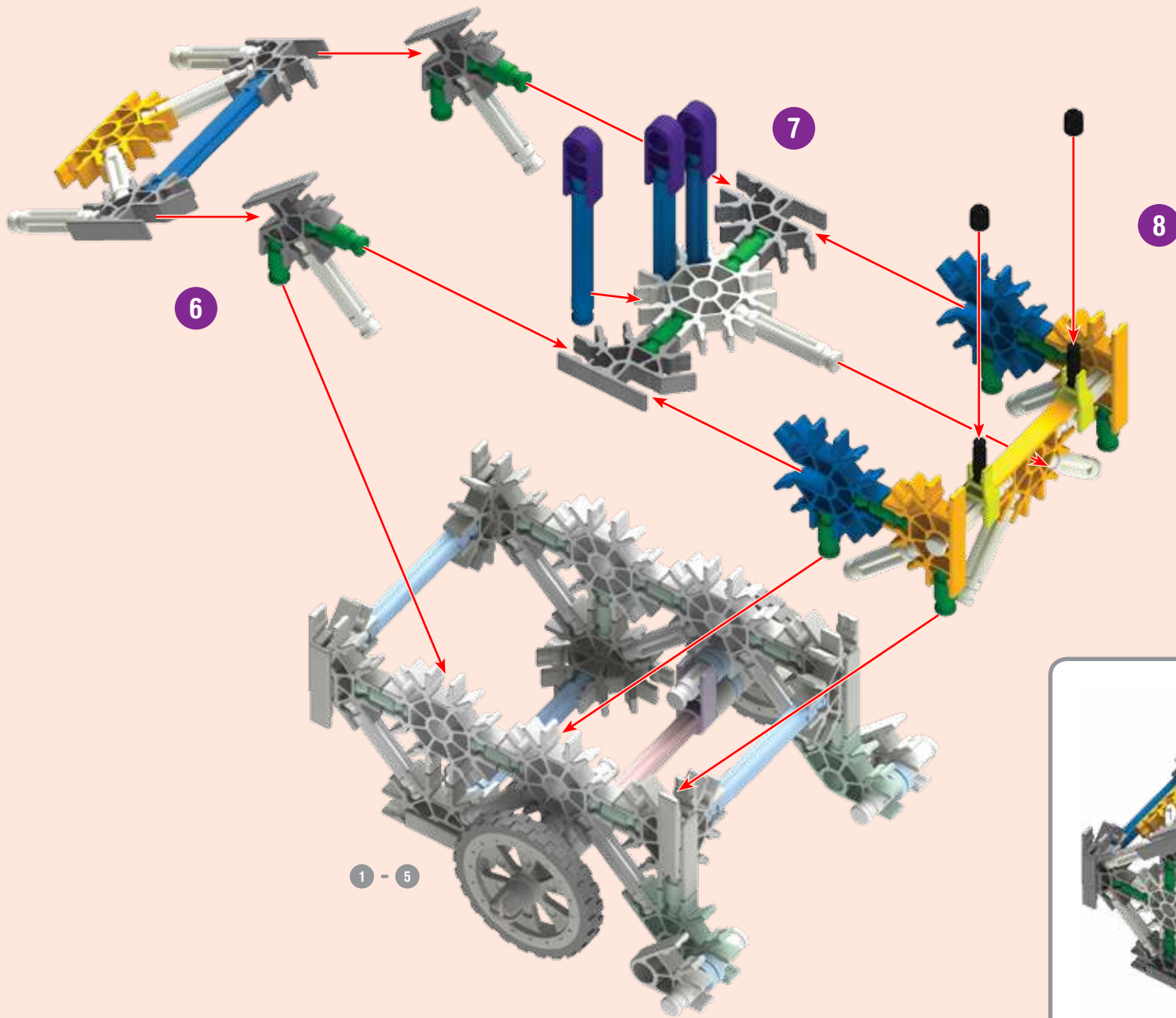

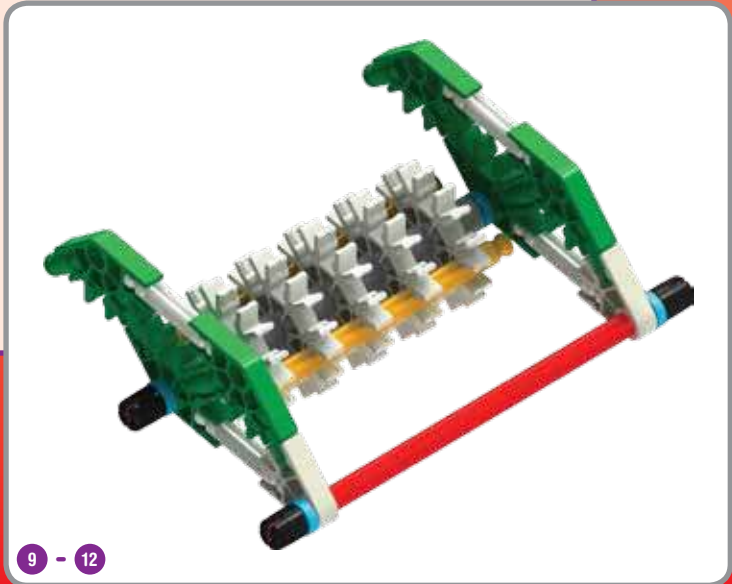
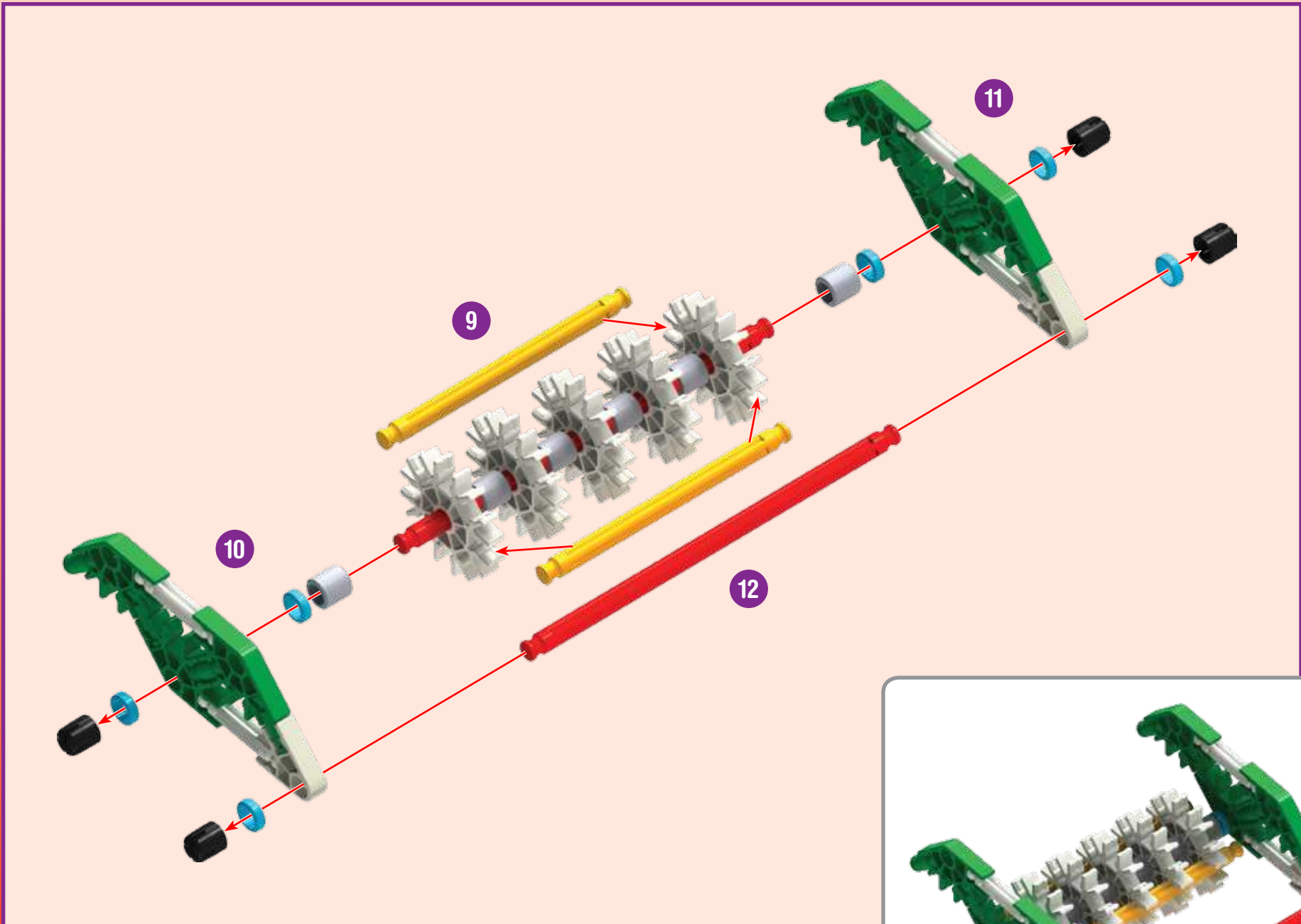

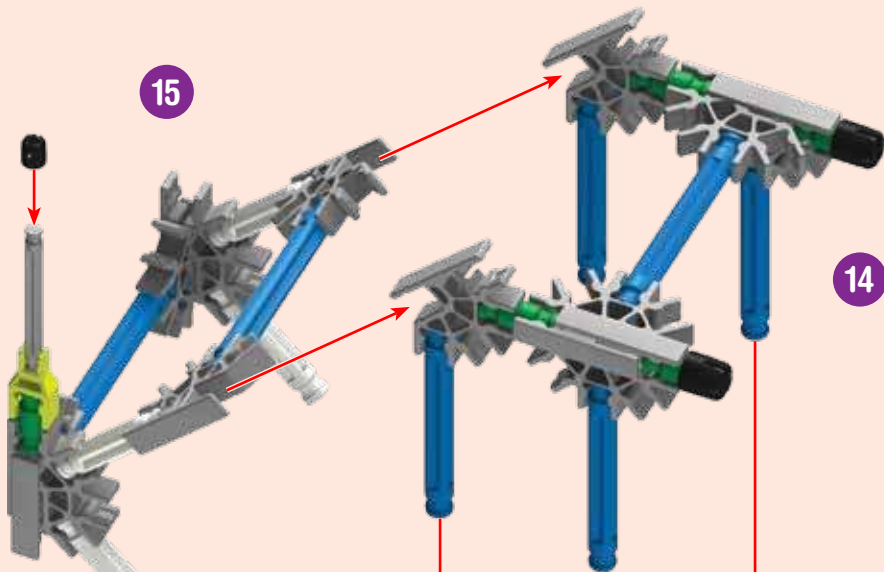

15

14



**Steamroller**  
**Rouleau Compresseur**

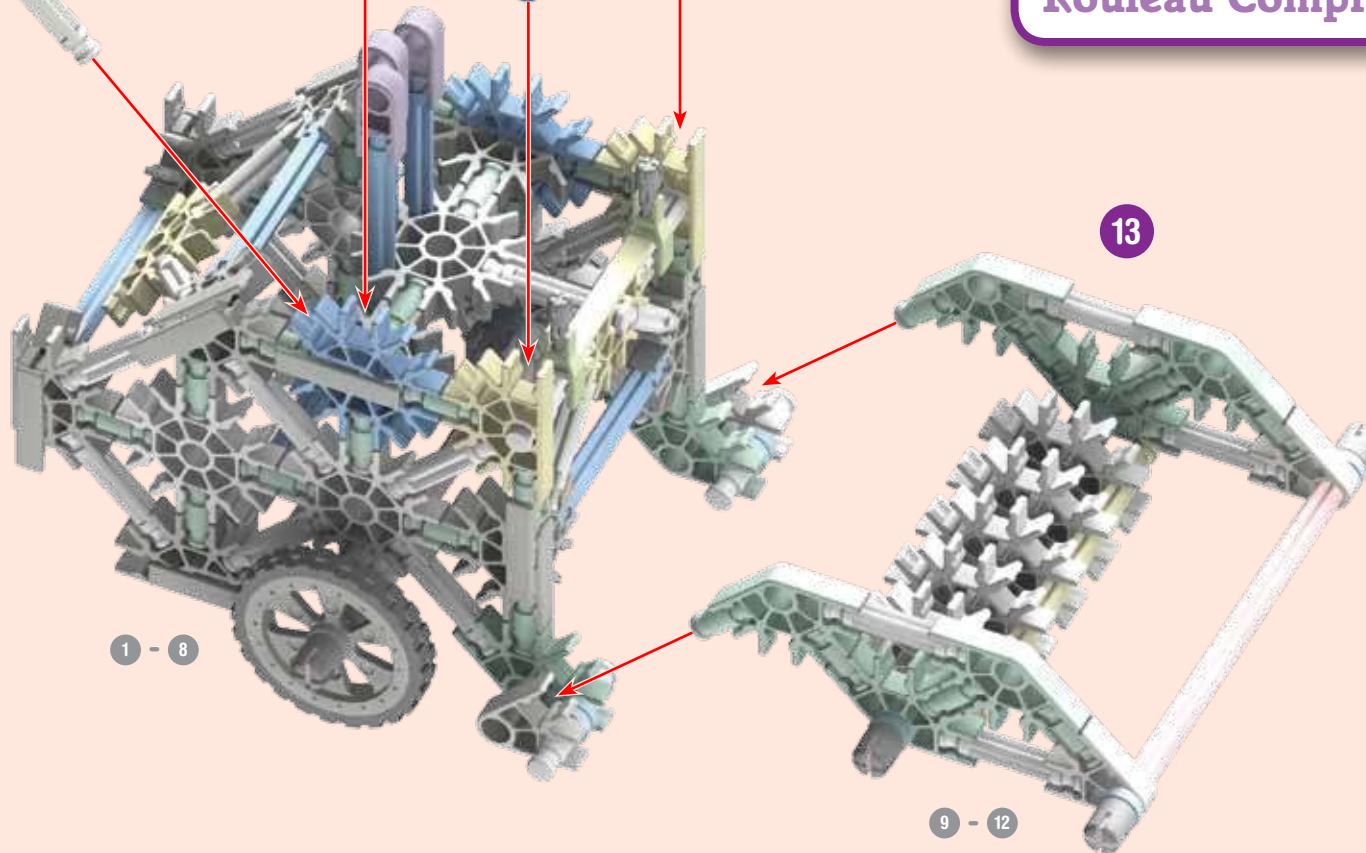

1 - 8

13

9 - 12

# Bomber Bombardier

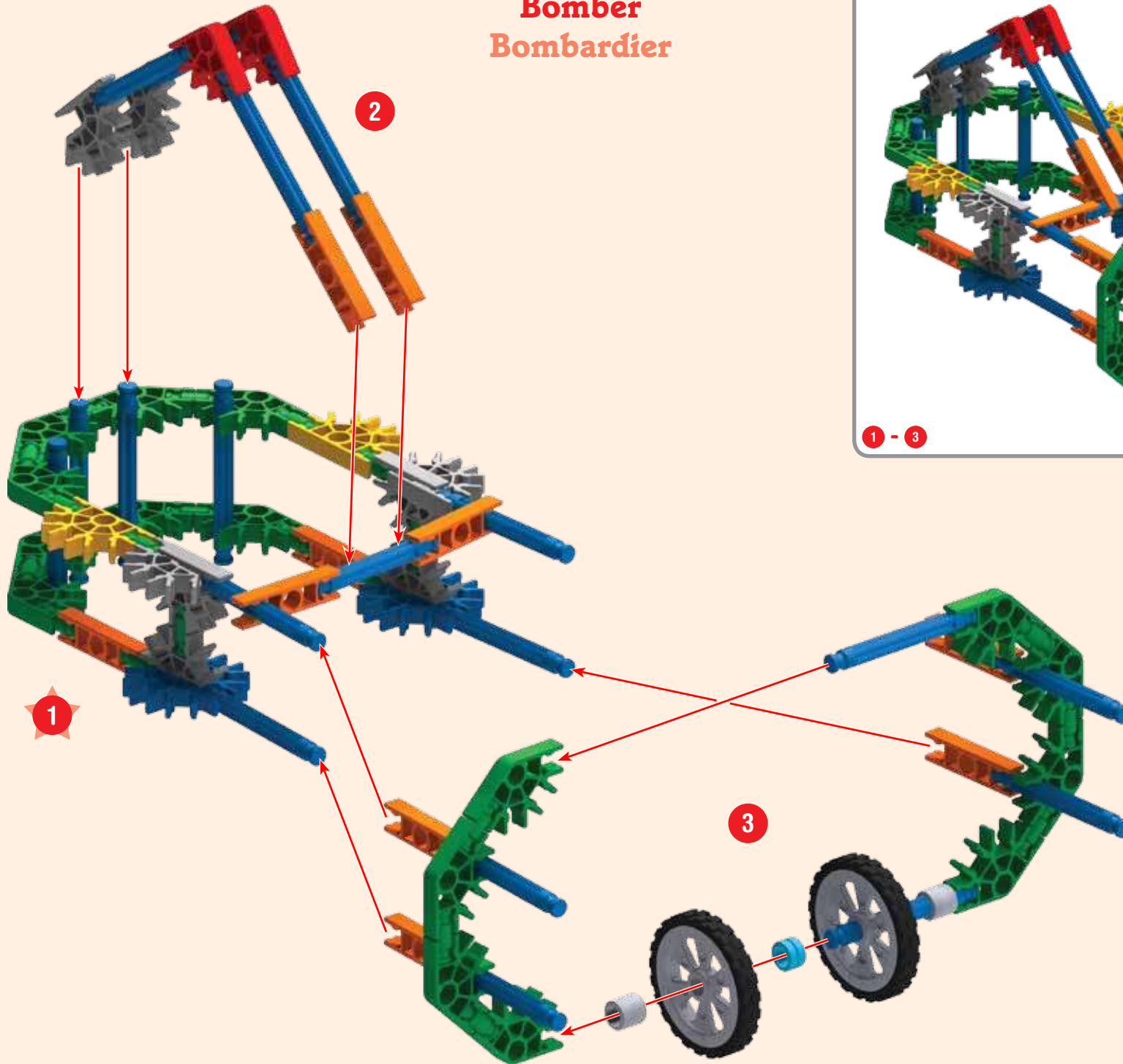

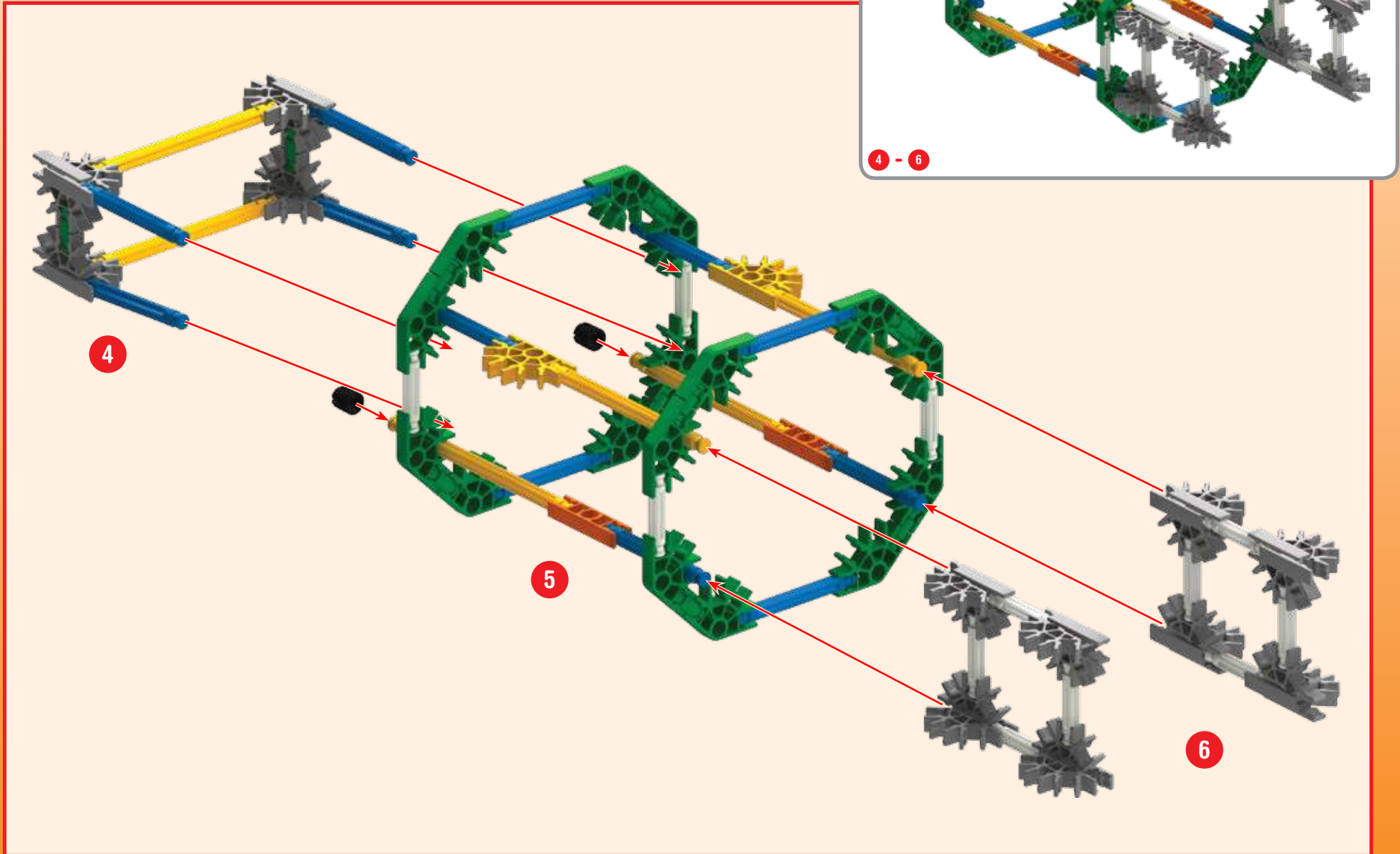

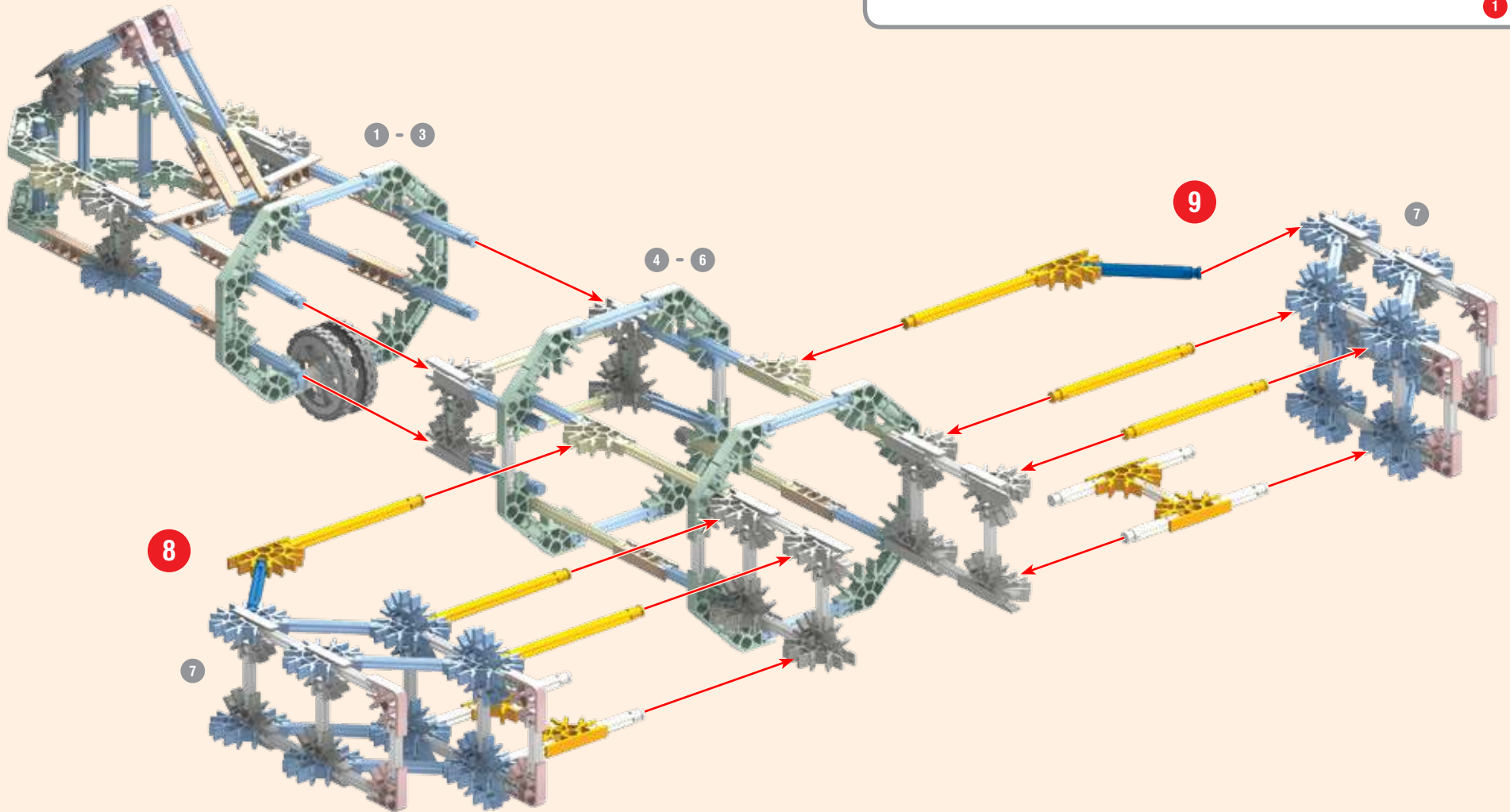
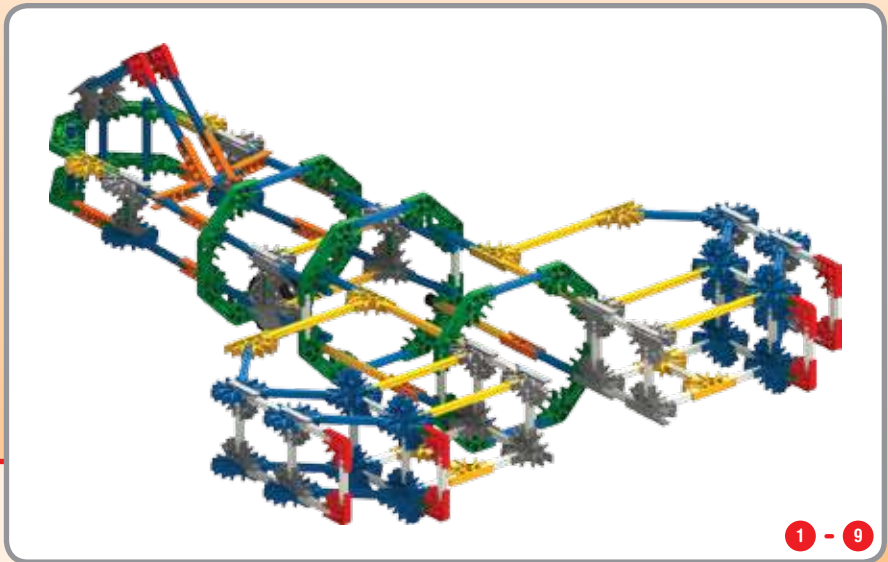
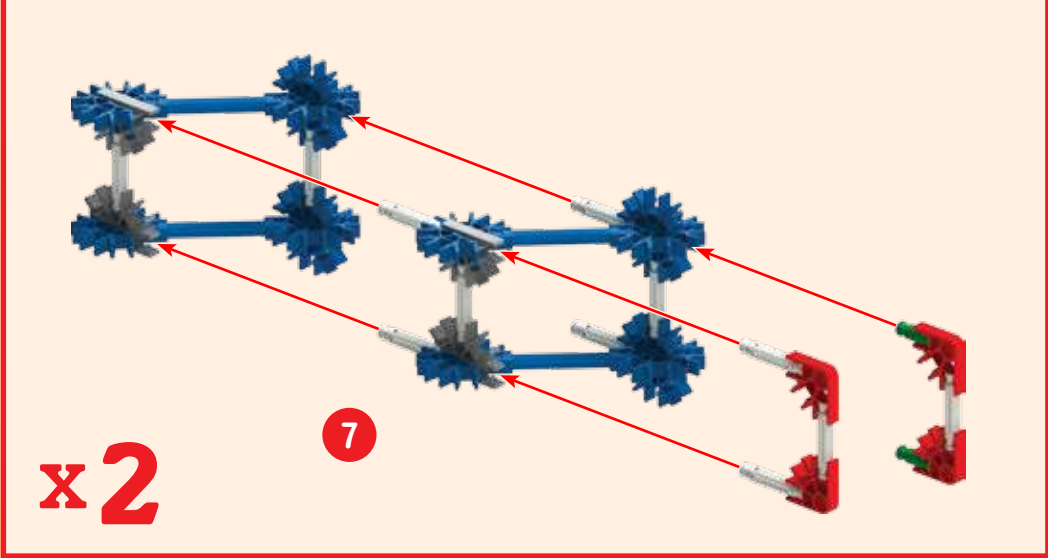

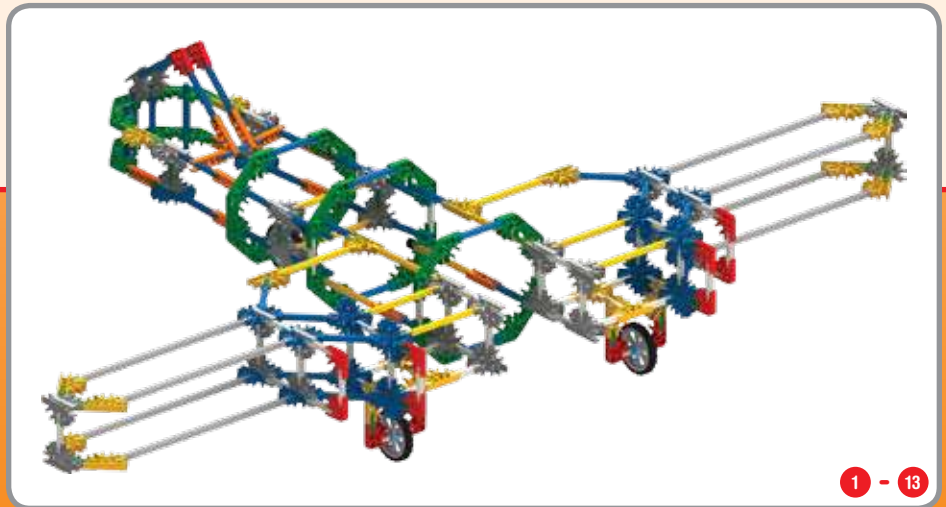
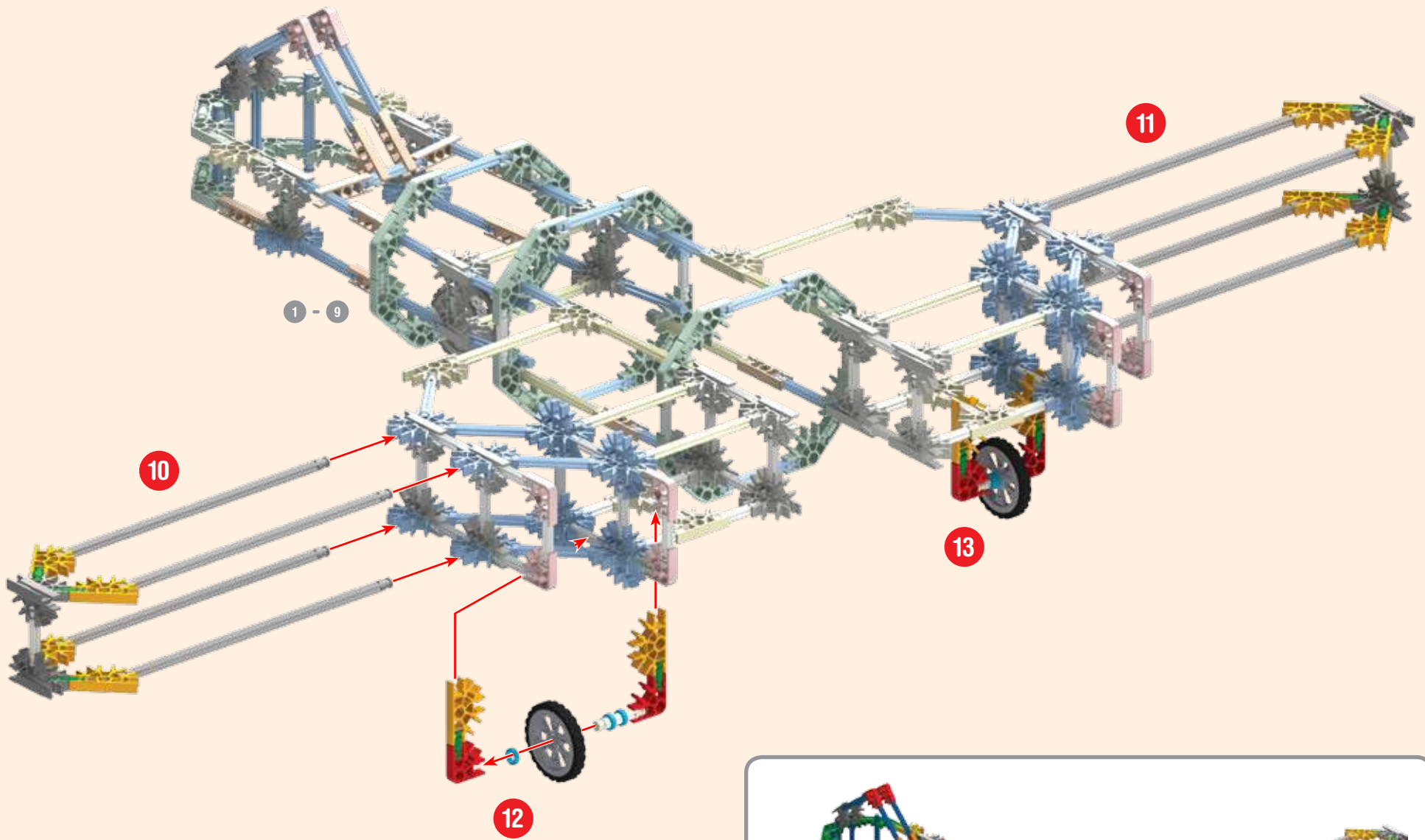

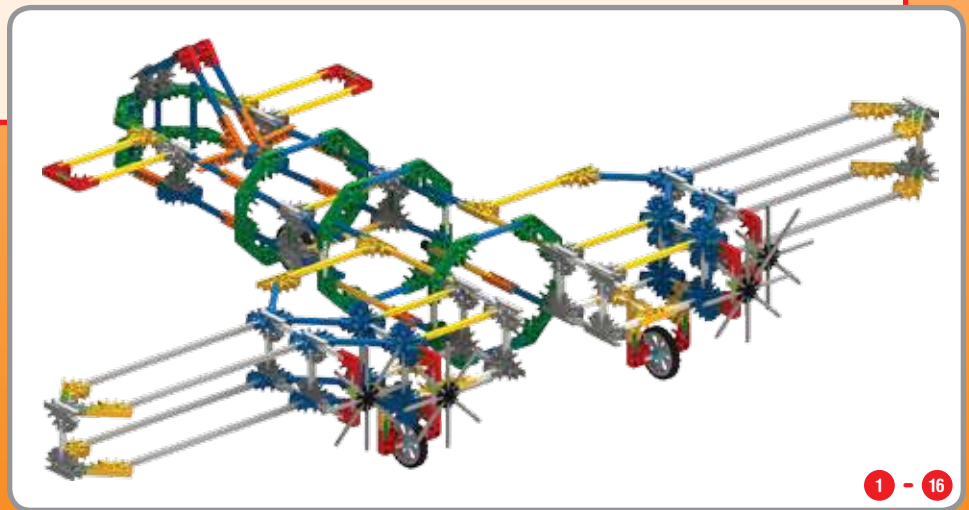
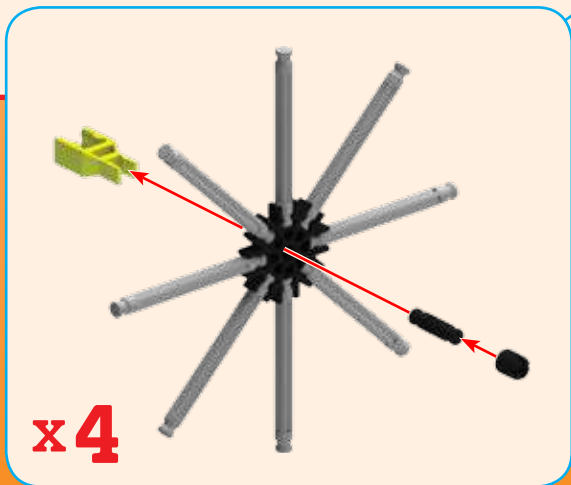
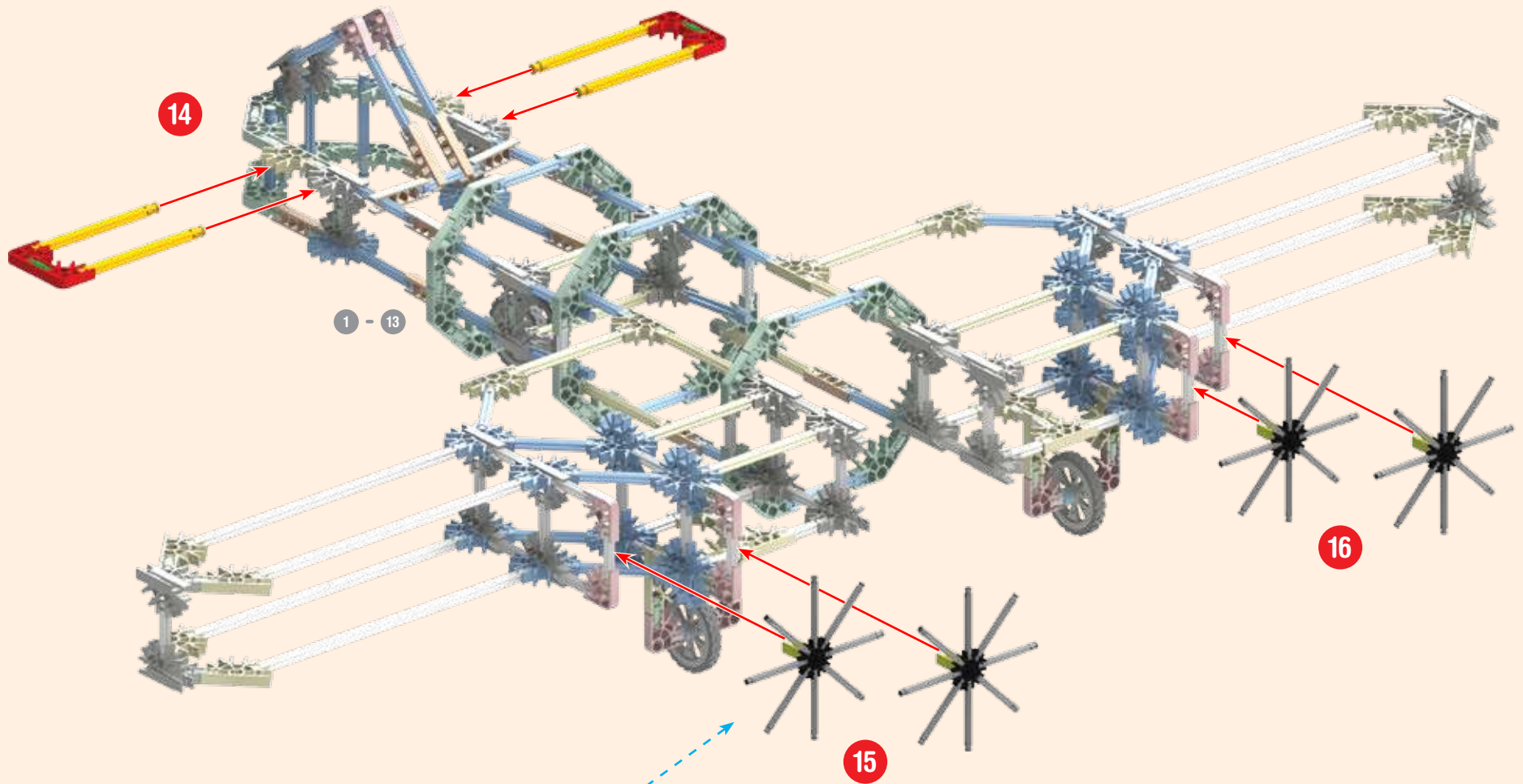



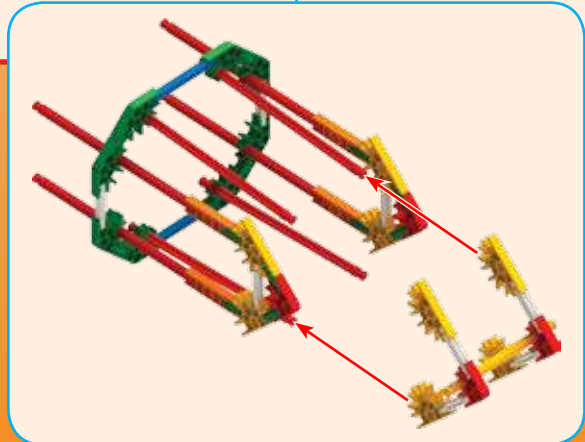
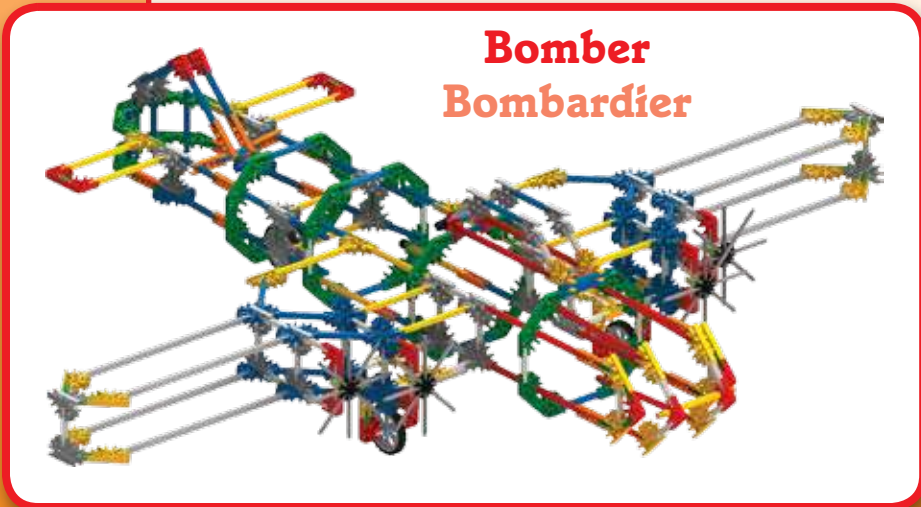
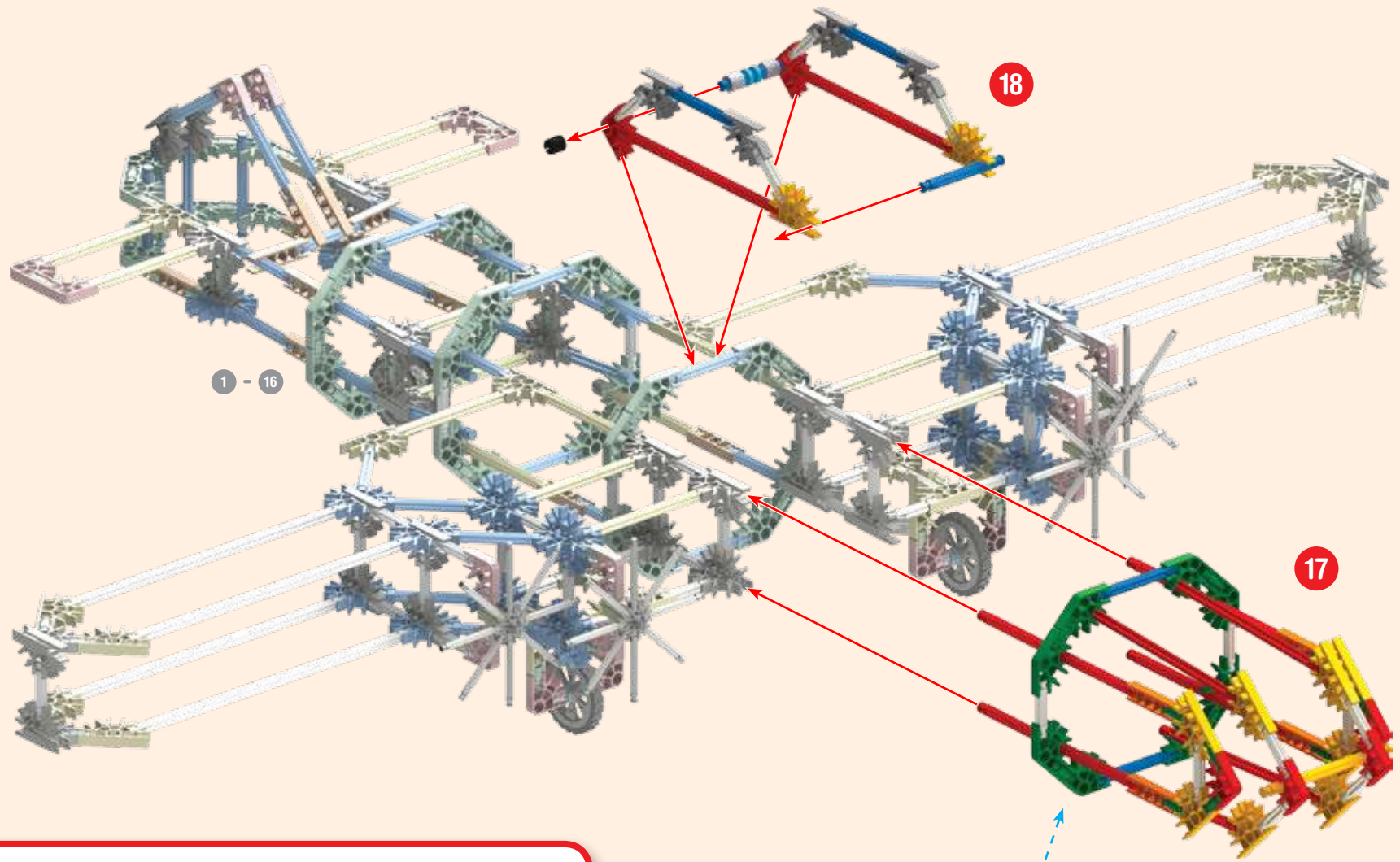

## (ES) **Esenciales de construcción K'NEX**

### **1. Para Comenzar a Construir**

Para comenzar el modelo, encuentre el número 1 del paso y siga los números. Cada pieza tiene su propia forma y color. Observe las imágenes, encuentre las piezas que sean iguales a las que se muestran y conéctelas. Colocar el modelo en la misma dirección que se encuentra en las instrucciones le facilitará la construcción. Las flechas muestran en dónde se conectan las piezas, pero no todos los puntos de conexión tienen flechas. Las partes de color tenue son las que ya armó.

### **2. Separadores**

Hay sitios en el modelo en los que necesita utilizar separadores. Asegúrese de usar el número correcto de separadores que se muestra en las instrucciones.

### **3. Conectores**

Puede unir estos conectores especiales deslizándolos Presione con fuerza hasta que oiga un "clic". Preste especial atención a las instrucciones y colóquelos de forma horizontal o vertical, exactamente como se muestra.

### **4. Lista de Piezas**

Antes de comenzar a construir, compare las piezas de su juego con las que se enumeran aquí. Si falta algo, llámenos o escríbanos utilizando la información que se encuentra en el reverso. ¡Estamos aquí para ayudarle!

**(Página 4)** Car les instructions de ces modèles vont à [www.knex.com/instructions](http://www.knex.com/instructions) et entrez dans le code 13465.

## (DE) **Grundlegende Bauanleitungen für K'NEX**

### **1. Los Geht's mit dem Bauen**

Um mit dem Bauen deines Modells zu beginnen, suche die Nummer 1 und folge den laufenden Nummern. Jedes Teil hat seine eigene Form und Farbe. Schau dir einfach die Abbildungen an, such die Teile in deinem Bausatz, die so aussehen wie das, was du auf der Abbildung siehst und steck sie ineinander. Versuche, dein Modell beim Zusammenbauen so zu orientieren, dass es in die gleiche Richtung weist, wie es in den Anleitungen beschrieben und gezeigt wird. Blasser Farben weisen darauf hin, dass dieser Streckenabschnitt bereits zusammengebaut ist.

### **2. Abstandsstücke**

An manchen Stellen in deinem Modell musst du Abstandsstücke einbauen. Achte darauf, die richtige Farbe und Anzahl von Abstandsstücken wie in der Anleitung gezeigt zu verwenden.

### **3. Verbindungsstücke**

Blaue und silberfarbene Verbindungsstücke haben besonders lange Schlitzlöcher. Wie du auf der Abbildung sehen kannst, lassen sie sich ineinander schieben. Achte beim Aneinanderfügen dieser Teile darauf, dass du ein Klickgeräusch hörst. Erst dann sind die Teile fest miteinander verbunden.

### **4. Teileliste**

Bevor du mit dem Bauen anfängst, solltest du prüfen ob die Teile in deinem Bausatz mit denen auf dieser Teileliste übereinstimmen. Falls etwas fehlt, rufe uns an oder schreibe uns (siehe Rückseite). Wir sind für dich da!

**(Seite 4)** Für Anweisungen dieser Modelle gehen sie zu [www.knex.com/instructions](http://www.knex.com/instructions) und geben sie Code 13465 ein.

## (IT) **Istruzioni di base per costruire con K'NEX**

### **1. Comincia a Costruire**

Per iniziare il modello, cerca il numero 1 e segui i numeri. Ogni pezzo ha una sua forma e un suo colore. Guarda la figura, trova i pezzi corrispondenti nel set e mettili insieme. Cerca di tenere il modello nella stessa direzione della figura e in tal modo sarà più semplice attaccare i pezzi nei posti giusti. I colori spenti ti dicono che questa sezione è già stata costruita. Dovrai collegare la nuova sezione al punto indicato dalla punta della freccia.

### **2. Spaziatori**

Ci sono punti nel tuo modello a cui dovrai aggiungere spaziatori blu e argento. Accertati di contarli attentamente.

### **3. Connettori**

È molto importante posizionare i connettori blu e argento in una specifica direzione. Presta molta attenzione alle istruzioni e posiziona i connettori orizzontalmente o verticalmente proprio come illustrato. Spingi con forza fino ad udire un clic.

### **4. Elenco delle Parti**

Prima di cominciare a costruire, accertati di confrontare le parti che sono nel tuo set con l'elenco delle parti qui. Se ne manca una chiamaci o scrivici usando le informazioni che sono nella retrocopertina. Noi siamo qui per aiutarti!

**(Pagina 4)** Per istruzioni di questi modelli vai a [www.knex.com/instructions](http://www.knex.com/instructions) e inserire il codice 13465.

## (PT) **Instruções básicas para montar o K'NEX**

### **1. Comece a Montar**

Para começar a montar o modelo, encontre o número do passo e siga os números. Cada peça tem a sua própria forma e cor. Estude as ilustrações, encontre as peças que coincidem com o que você estiver vendo e conecte-as. Fique de frente para o modelo, na mesma direção que as figuras mostradas nas instruções. As setas mostram onde as peças se conectam, mas nem todos os pontos de conexão têm setas. As partes com cores desbotadas são as que você já montou.

### **2. Separadores**

Há lugares no modelo onde você precisará usar separadores. Use o número de espaçadores corretos exibidos nas instruções.

### **3. Conectores**

Você pode fazer com que estes conectores se deslizem e se conectem. Empurre até ouvir um "clique". Preste atenção às instruções e posicione-os horizontal ou verticalmente exatamente conforme a ilustração.

### **4. Lista das Peças**

Antes de começar a montar, compare as partes do seu conjunto com as partes enumeradas aqui. Se houver algo que estiver faltando, ligue ou escreva para nós usando as informações na capa de trás. Estamos aqui para servir e ajudar.

**(Página 4)** Para obter instruções destes modelos vá em [www.knex.com/instructions](http://www.knex.com/instructions) e digite o código 13465.

## (NL) Basisstappen voor K'NEX bouwen

### 1. Begin te Bouwen

Om met je model te beginnen, vind eerst het nummer 1 en volg de nummers. Elk stuk heeft zijn eigen vorm en kleur. Kijk gewoonweg naar de afbeeldingen, vind de overeenstemmende stukken terug in je geheel en maak e aan mekaar vast. Tracht je model in dezelfde richting te plaatsen als de aanwijzingen terwijl je bouwt en monteert. De vervaagde kleuren duiden aan dat dit deel reeds is opgebouwd. Gelieve het nieuwe deel vast te koppelen op de plaats aangeduid door de pijlen.

### 2. Tussenstukken

In je model zijn er plaatsen waar blauwe en zilveren tussenstukken moeten toegevoegd worden. Verzekert je ervan de juiste kleur te gebruiken en tel ze zorgvuldig.

### 3. Koppelstukken

Er zijn blauwe en zilveren koppelstukken met speciale lange gleuven. Ze schuiven in mekaar zoals je kunt zien op de afbeeldingen. Duw deze onderdelen in mekaar tot je een "klik" hoort.

### 4. Onderdelen Lijst

Voordat u begint met bouwen, moet u de onderdelen vergelijken de set met de onderdelen lijst hier. Als er iets ontbreekt, bel of schrijf ons gebruik van de informatie op de achterkant. We zijn hier om u te helpen!

**(Bladzijde 4)** Voor instructies van deze modellen naar [www.knex.com/instructions](http://www.knex.com/instructions) en vul de code 13465.

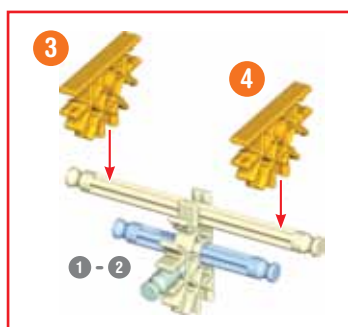
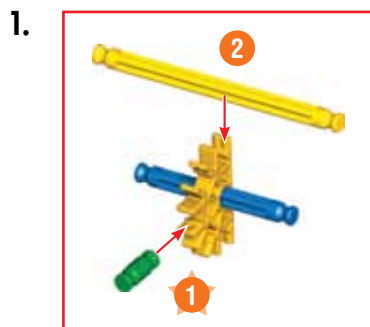

4.

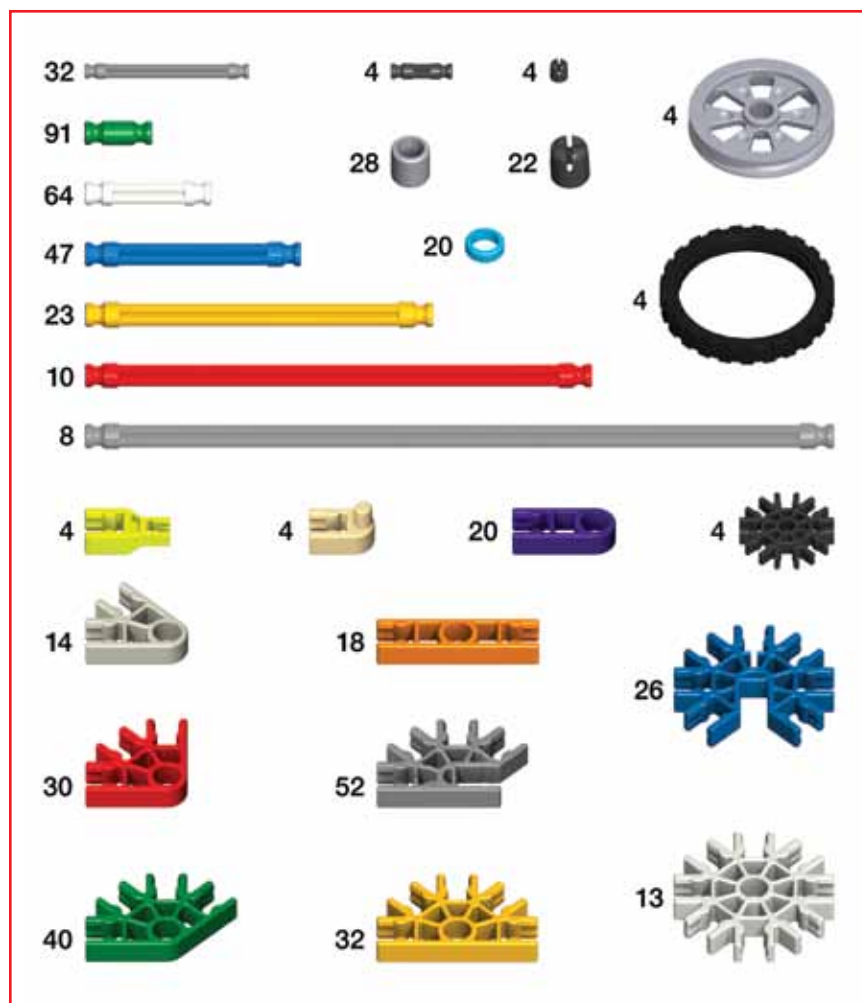

3.

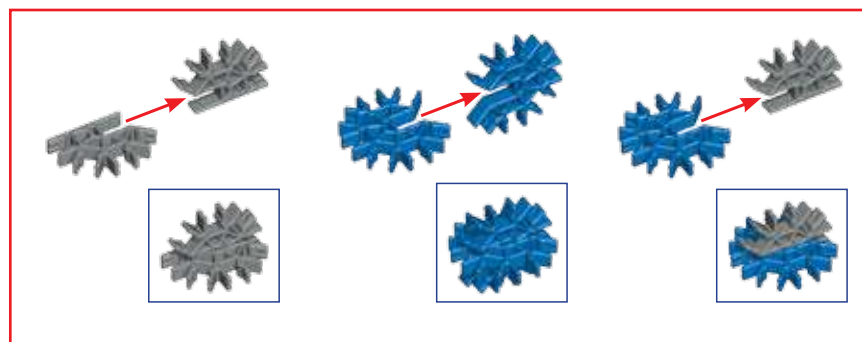

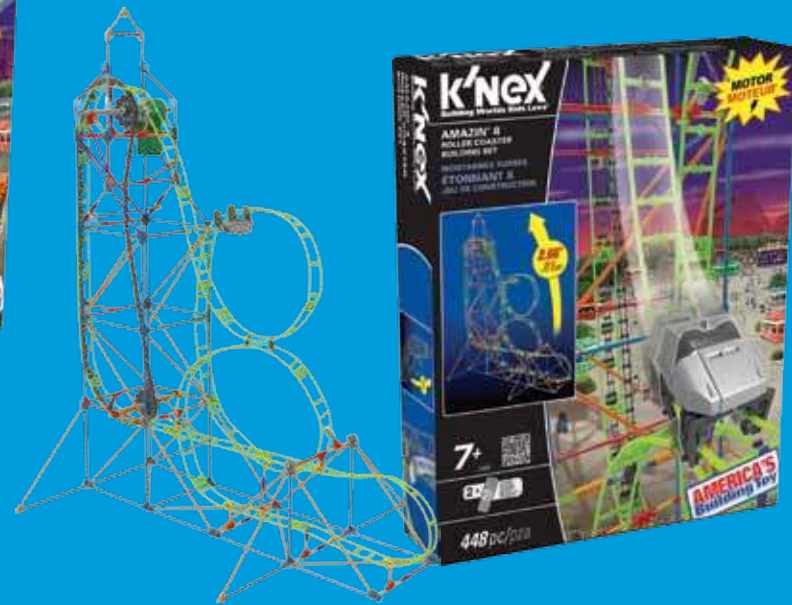

Sold separately.  
Vendus séparément.  
Se venden por separado  
Separat erhältlich.  
Venduti separatamente  
Vendidos separadamente.  
Afzonderlijk verkocht

**!** WARNING: CHOKING HAZARD – Small parts. Not for children under 3 years.

**ATTENTION ! RISQUE D'ÉTOUFFEMENT** – Petite taille. Ne convient pas aux enfants de moins de 3 ans.

**ADVERTENCIA: PELIGRO DE ASFIXIA** – Piezas pequeñas. No recomendado para niños menores de 3 años.

**WARNING: ERSTICKUNGSGEFAHR** – Kleinteile. Nicht für Kinder unter 3 Jahren.

**AVVISO: PERICOLO DI SOFFOCARE** – Pezzi piccoli. Non adatto per bambini sotto 3 anni.

**AVISO: PERIGO DE SUFOCAÇÃO** – Peças pequenas. Não indicado para crianças menores de 3 anos.

**WAARSCHUWING: VERSTIKKINGSGEVAAR** – KLEINE ONDERDELEN. Niet voor kinderen onder 3 jaar.

**CAUTION:** Use care where you use these models. Models could damage furniture or walls, or injure people or pets.

**ATTENTION :** Utilisez des soins là où vous utilisez ce modèles. Modèles pourrait endommager les meubles ou les murs, ou blesser des personnes ou des animaux domestiques.

**PRECAUCIÓN:** Tenga mucho cuidado cuando se utiliza este modelos. Modelos podría dañar los muebles las paredes, o lesionar a personas o animales.

©2014 K'NEX Limited Partnership Group, P.O. Box 700, Hatfield, PA 19440-0700; 1-800-KID-KNEX (USA/Canada/États-Unis/EE.UU.); email@knex.com; knex.com.

(EN) K'NEX and Building Worlds Kids Love are registered trademarks of K'NEX Limited Partnership Group. Product and colors may vary. For customers outside the USA and Canada please contact your local distributor at [www.knex.com/distributors](http://www.knex.com/distributors).

(FR) K'NEX et Building Worlds Kids Love sont des marques déposées de K'NEX Limited Partnership Group. Produits et couleurs peuvent varier. Le Service clients hors États-Unis et Canada, s'il vous plaît contacter le distributeur local. L'information de distributeur peut être trouvée à [www.knex.com/distributors](http://www.knex.com/distributors).

(ES) K'NEX y Building Worlds Kids Love son marcas registradas de K'NEX Limited Partnership Group. El producto y los colores pueden variar. El cliente que no vive en EE.UU. y Canadá se pone en contacto con el distribuidor local. Encuentre la información para el distribuidor local en [www.knex.com/distributors](http://www.knex.com/distributors).

K'NEX UK Ltd., P.O. Box 3083, Reading RG1 9YQ, England. (AUS) Headstart International Pty Ltd., Level 1, 492 St Kilda Rd, Melbourne, VIC 3004, Australia. (NL) BOTI Europe B.V., Vlijtseweg 89-91, 7317 AE Apeldoorn, Netherlands. (MEX) Distribuidora Mejicoro S.A. de C.V., Av. Coatepec No. 520 B 34A, San Bartolome Coatepec, Huixquilucan Estado de Mexico 52770, Mexico.



**f** [facebook.com/buildknex](https://facebook.com/buildknex)

