

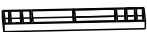









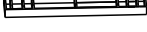

62138EG

# Assemble instruction

DINING TABLE 220x100

NO.	Picture	Name	Qty
A		Table Top	1
B		Table Top	1
C		Table Top	1
D		Table Leg	2
E		Support Tube	3
F		PVC Bolt Cover	18
G		M6X35MM Bolt	18
H		Steel Washer	18
I		Wrench 4#	1
J		PVC Bolt Cover	16
K		M8X25MM Bolt	16
L		Steel Washer	16
M		Wrench 5#	1

STEP 1

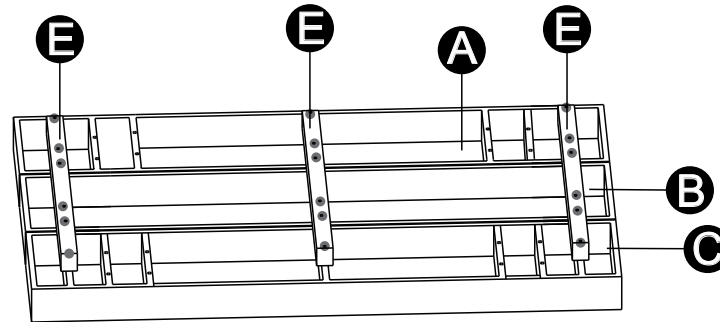
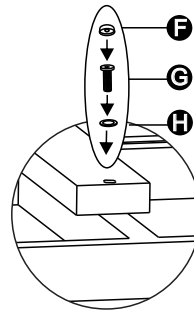

STEP 2

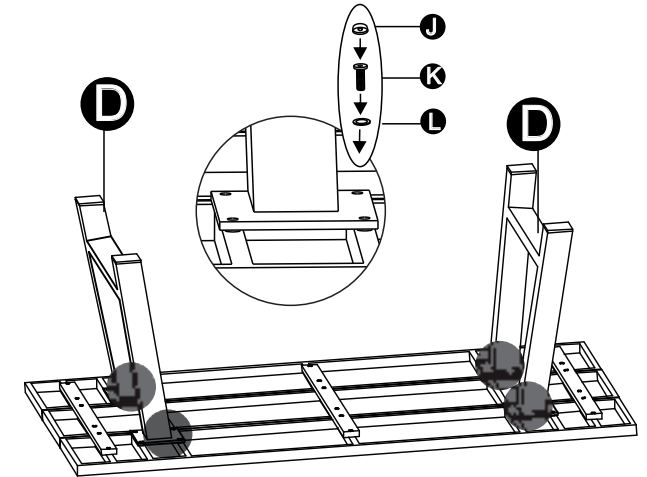

STEP 3

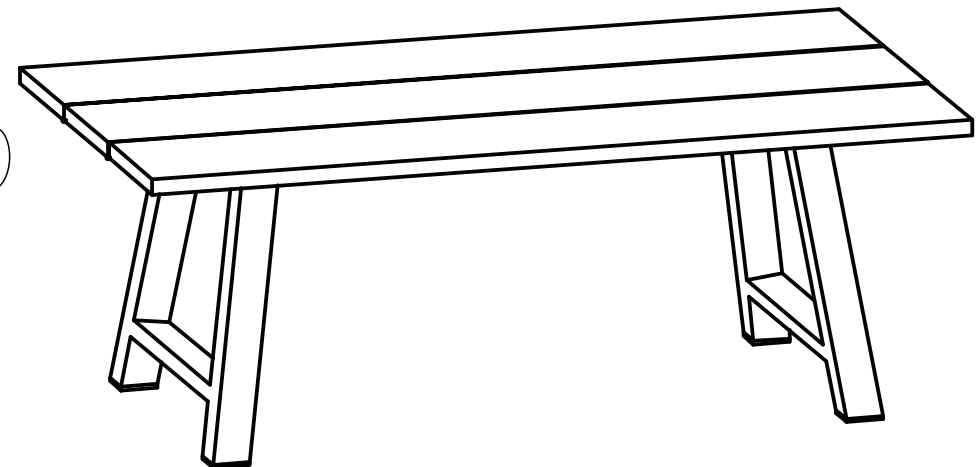
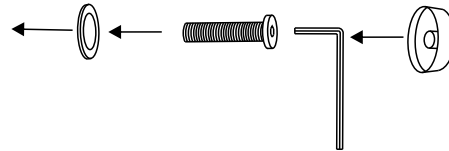

Let op: Bij het monteren van het meubel eerst alle schroeven half indraaien.  
Pas als alle schroeven op de plek zitten alles vast draaien.

Note: When assembling the furniture, first screw all screws halfway.  
When all the screws are in place, tighten everything.

Achtung! Um die Montage des Möbelstückes zu vereinfachen,  
erst alle Schrauben handfest andrehen und am Ende erst alle Schrauben  
fest anziehen.

Attention: Avec votre meuble, tous les visser par rapidement monter.  
Ci tout sur son place, vous pouvez les monter.