

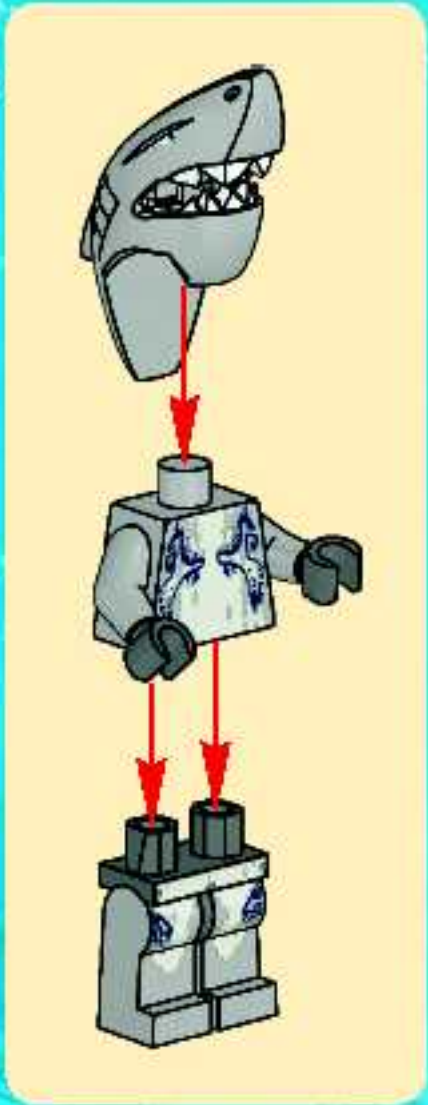

ATLANTIS

8057





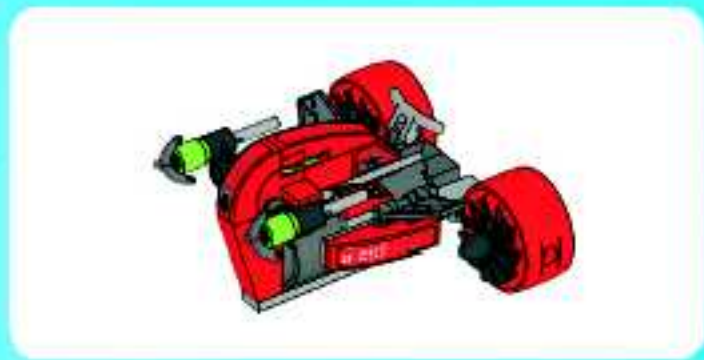

1

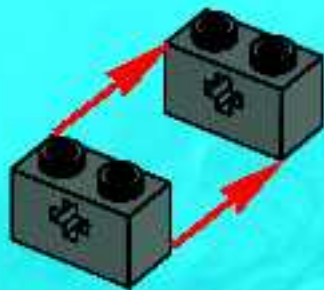

2



3

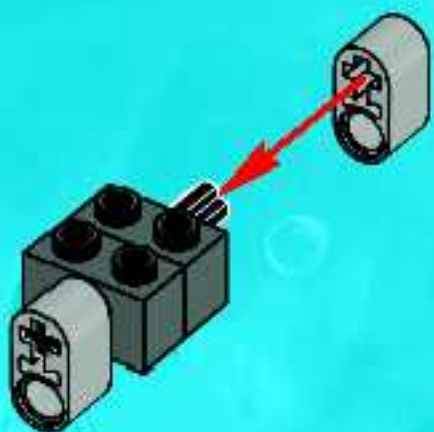

4

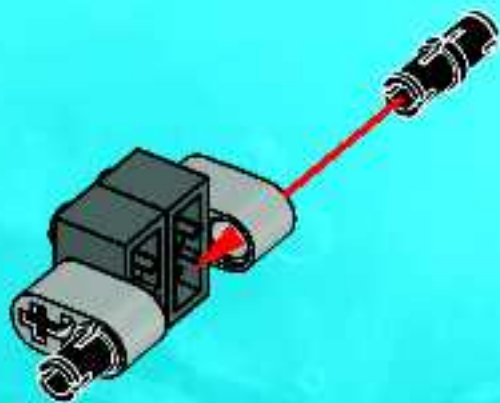

5

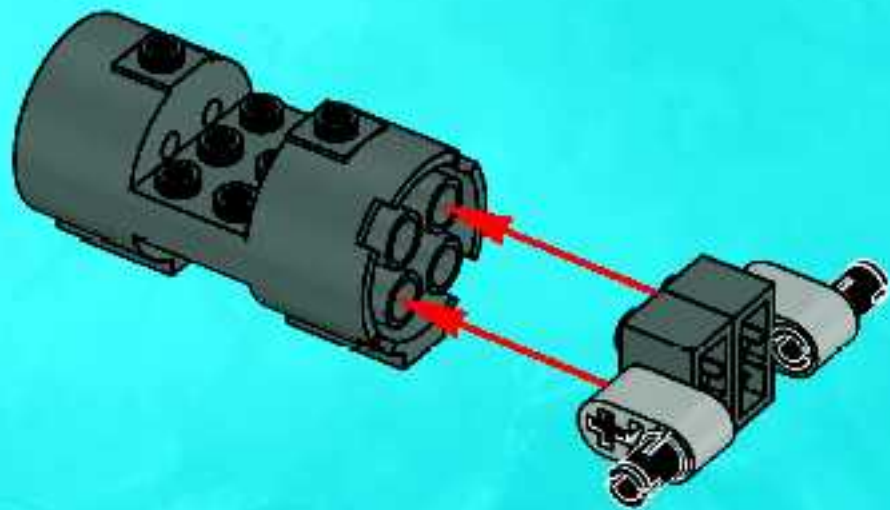

6

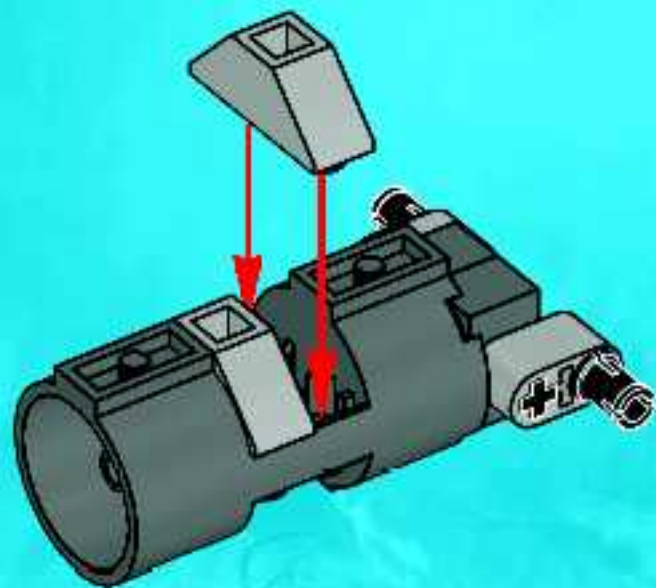

9

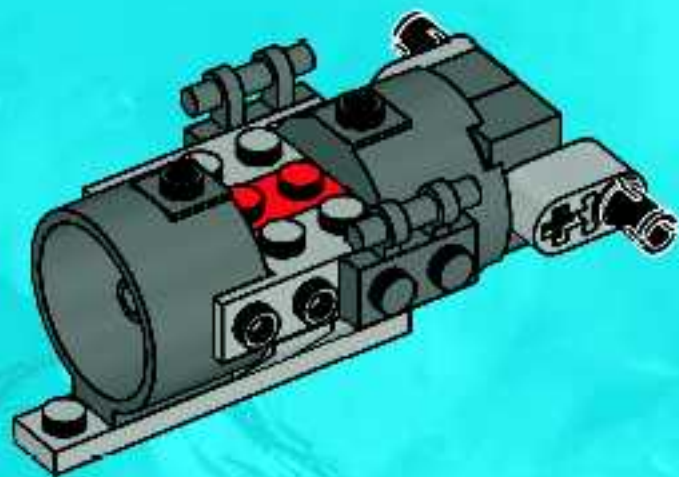

10

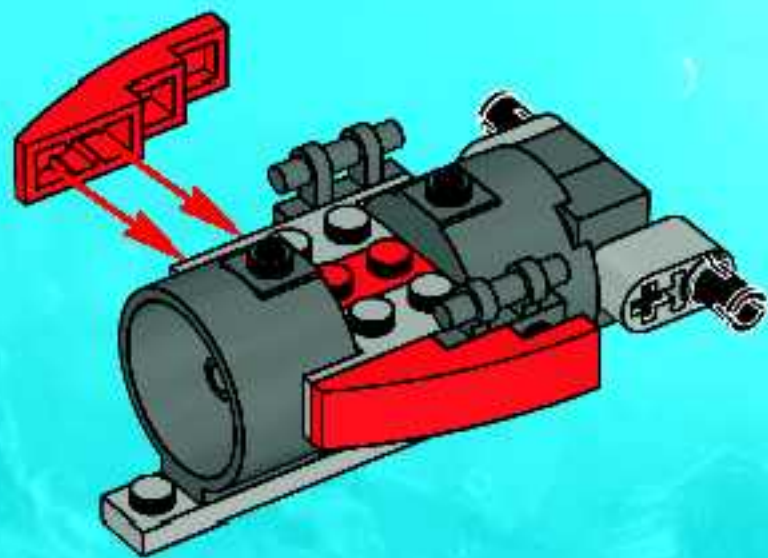

11

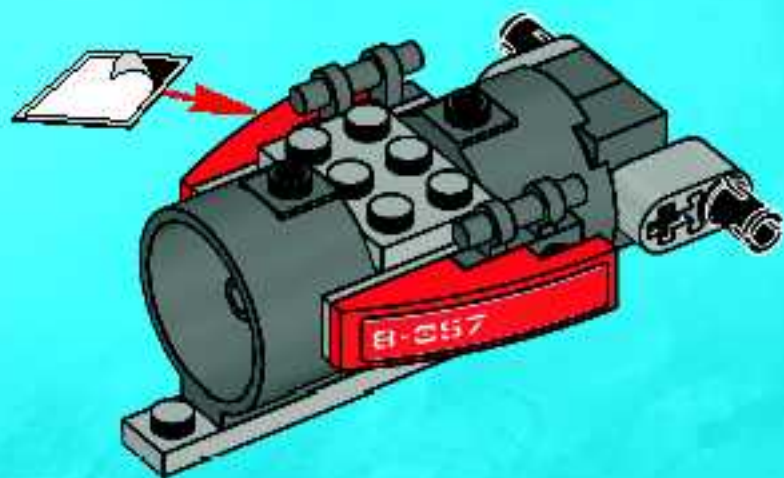

12

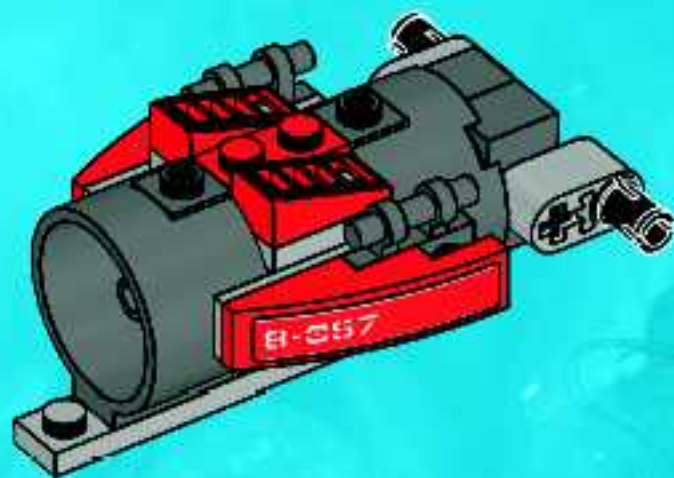

13

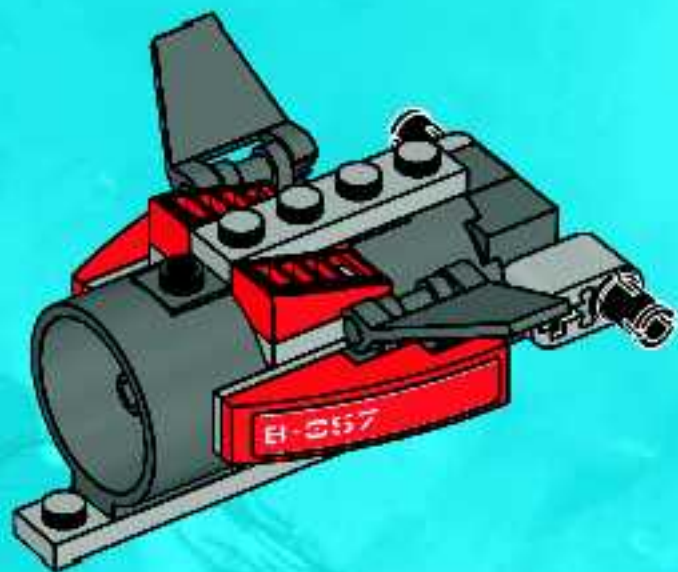

14

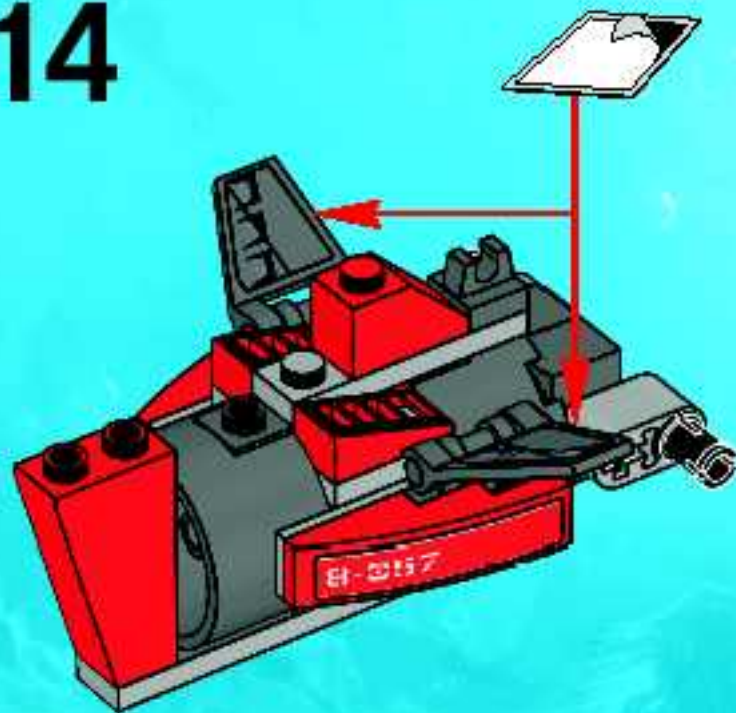

15

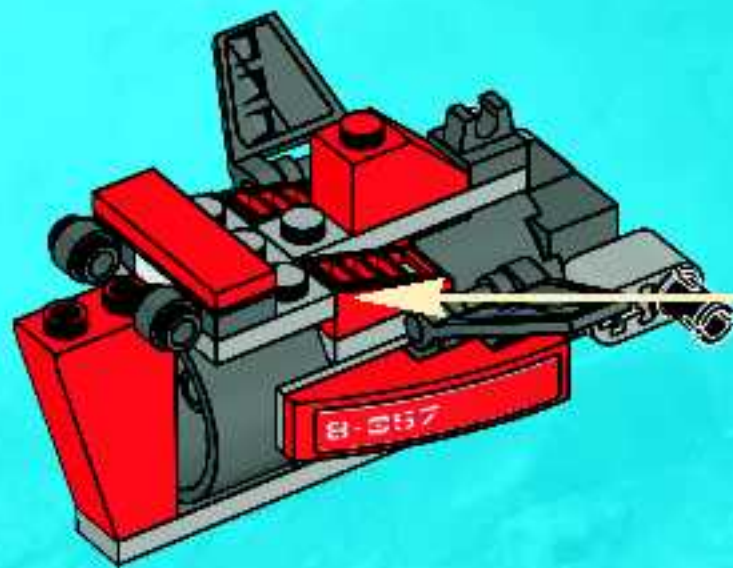
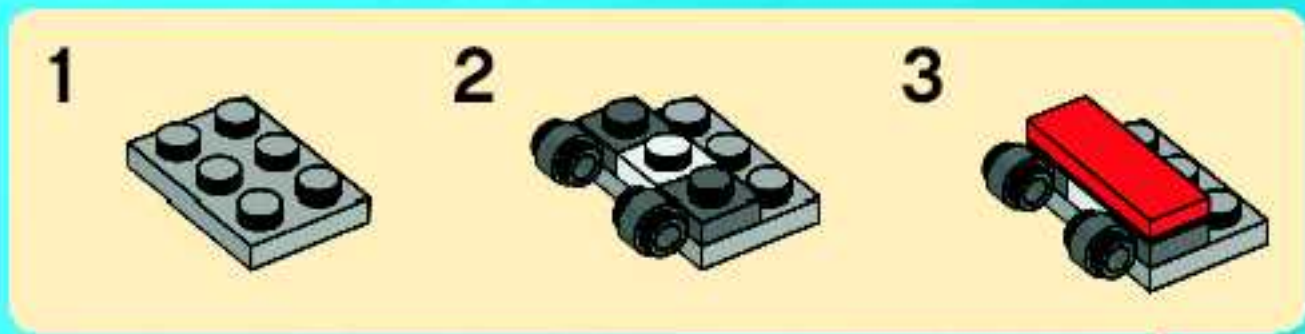

16

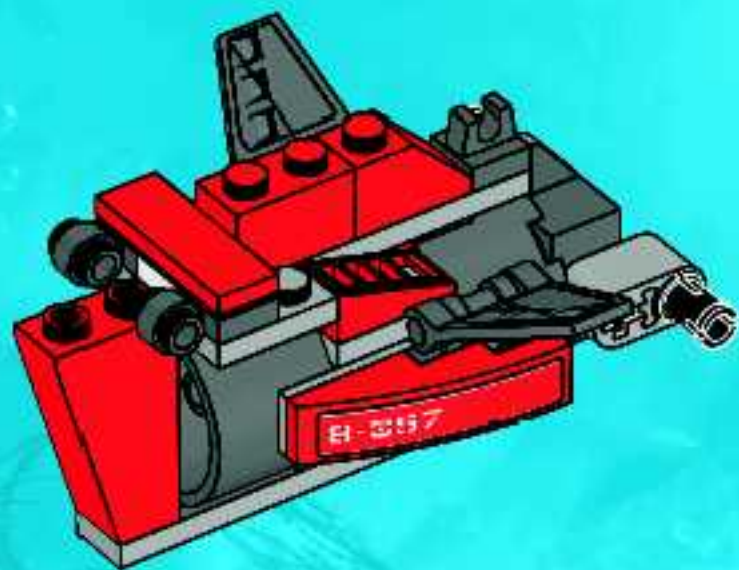

17

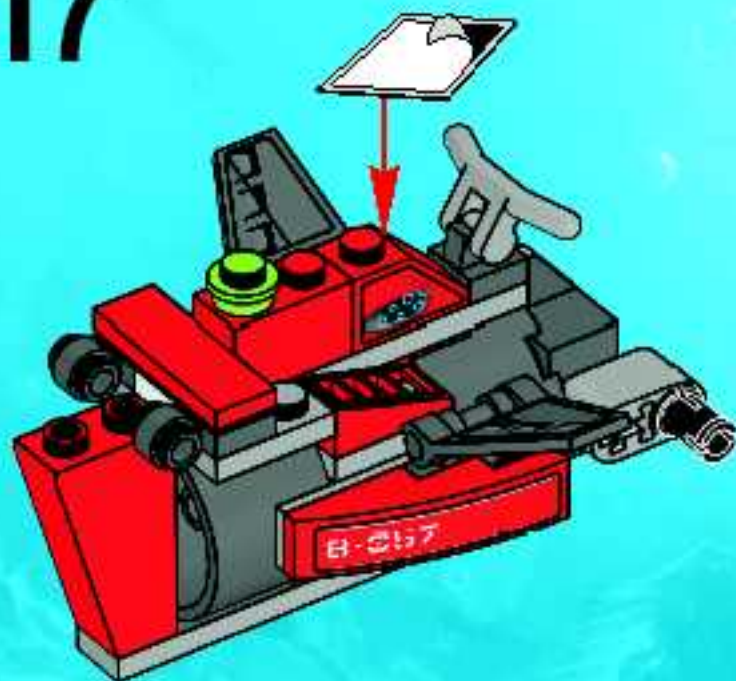

18

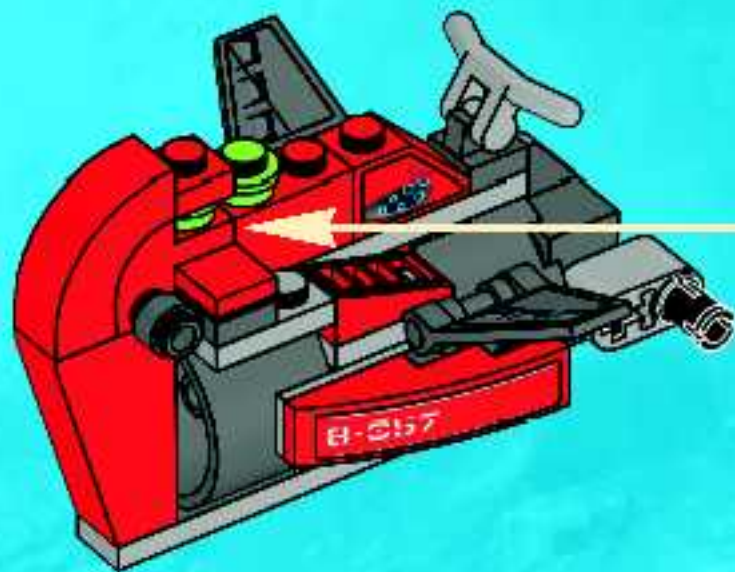

19

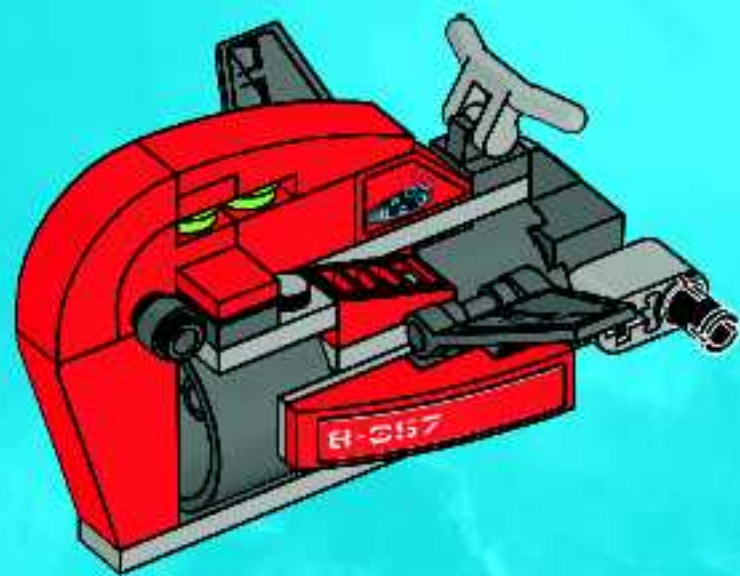

20

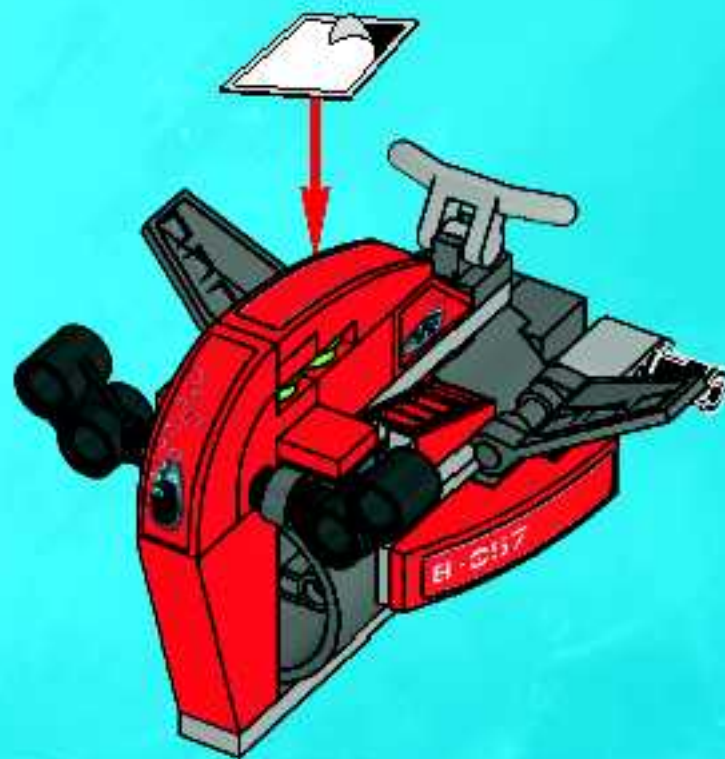

21

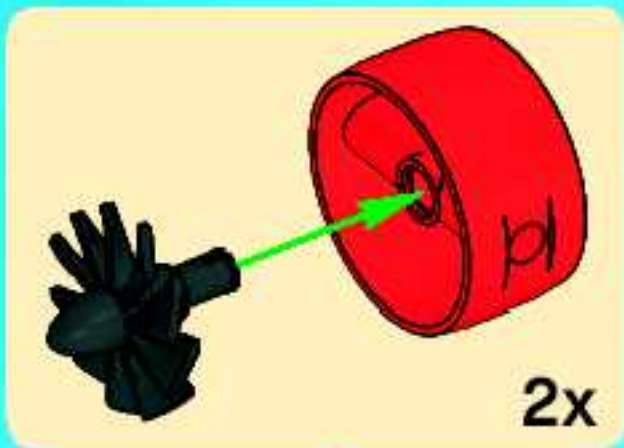

1

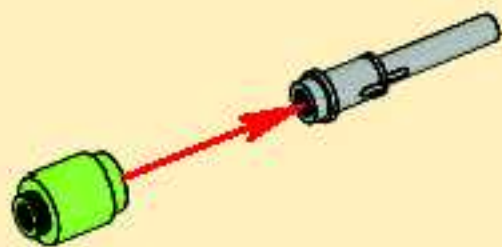

2

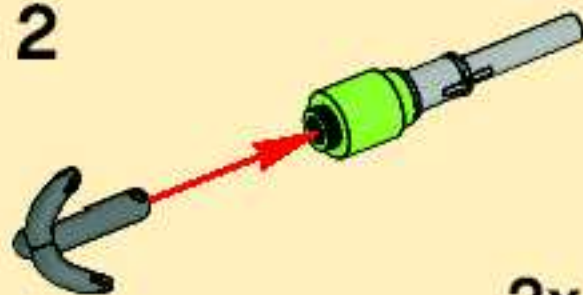

2x

22

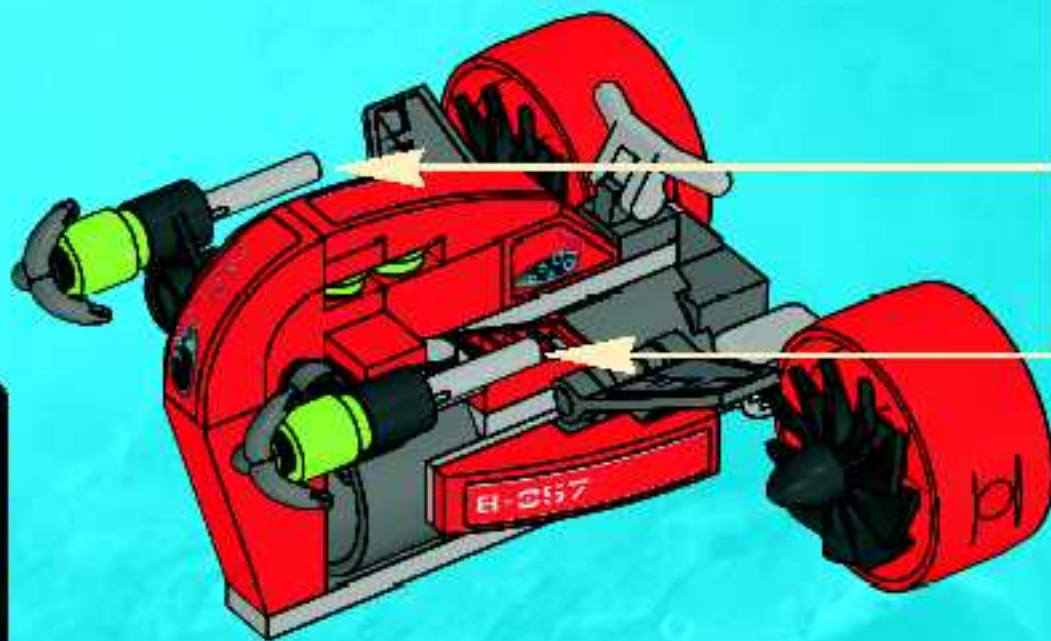

8060



8061



8075





8056



8057



8058



8059





8056



8057



8058



8059



8060



8061



8075

ATLANTIS.LEGO.COM



ATLANTIS



Customer Service

Kundenservice

Service Consommateurs

Servicio Al Consumidor

www.lego.com/service or dial



00800 5346 5555 :



1-800-422-5346 :



FREE! GRATIS! GRATUIT!



club
MAGAZINE™

www.LEGOclub.com



00800 5346 5555*        

  **1-866-534-6258 • 1-877-518-5346**

UK & Canada only

Canada seulement

* Free phone. Mobile charges may apply. * Numéro sans frais. Des frais peuvent s'appliquer avec les téléphones cellulaires.

* Gebührenfrei. Kosten für Anrufe aus Mobilfunknetzen können abweichen. * Grátis telefonnummer vanaf vaste lijn.

* Døder ett gratis nummer, uti du ringer fra Posttelefon. * Net är gratis, uti du ringer från Post telefon.



VISIT THE WORLD'S
BIGGEST LEGO® SHOP!

www.LEGOshop.com



WIN!

 www.LEGO.com

Go to www.nielsen.com/LEGO to fill out a survey for a chance to win a cool LEGO® Product. No purchase necessary. Open to all residents where not prohibited.



www.nielsen.com/LEGO

GEWINNE!

Nimm an der Umfrage auf www.nielsen.com/LEGO teil und hab die Chance ein cooles LEGO® Produkt zu gewinnen! Die Teilnahme am Gewinnspiel führt zu keinerlei Kaufverpflichtungen. Teilnahme in allen nicht ausgeschlossenen Ländern möglich.

WIN!

Ga naar www.nielsen.com/LEGO, vul een enquêteformulier in en maak kans op een cool LEGO® product. Geen aankoopverplichting. Iedereen mag deelnemen, uitgezonderd ingezetenden van landen waar een enquêteverbod geldt.

GAGNE!

Visite www.nielsen.com/LEGO pour répondre à un questionnaire et avoir une chance de gagner un produit LEGO® très cool! Aucune obligation d'achat. Ouvert à tous les résidents des pays autorisés.

当てよう!

www.nielsen.com/LEGO にアクセスして、アンケートにご記入ください。当選者にはレゴ製品を差し上げます。お買い上げの義務はありません。閉止されている国は、すべての地域にご利用いただけます。

4584880

LEGO and the LEGO logo are trademarks of the LEGO Group. ©2010 The LEGO Group. ©2010 LucasFilm Ltd. & TM. All rights reserved. Used under authorization.