



RAZER BASILISK X HYPER SPEED

MASTER GUIDE

Game wirelessly with a fast, reliable connection — featuring dual-mode Razer™ HyperSpeed Wireless and Bluetooth connectivity. Our Razer™ Locus+ Optical Sensor comes with 16,000 DPI for precise swipes while the Razer™ Mechanical Mouse Switch offers a highly durable life cycle of up to 50 million clicks.

CONTENTS

1. WHAT'S INSIDE.....	3
2. WHAT'S NEEDED.....	4
3. LET'S GET YOU COVERED.....	4
4. TECHNICAL SPECIFICATIONS.....	5
5. GETTING STARTED.....	6
6. SAFETY AND MAINTENANCE.....	12
7. LEGALESE.....	14

1. WHAT'S INSIDE

RAZER BASILISK X HYPERSPEED

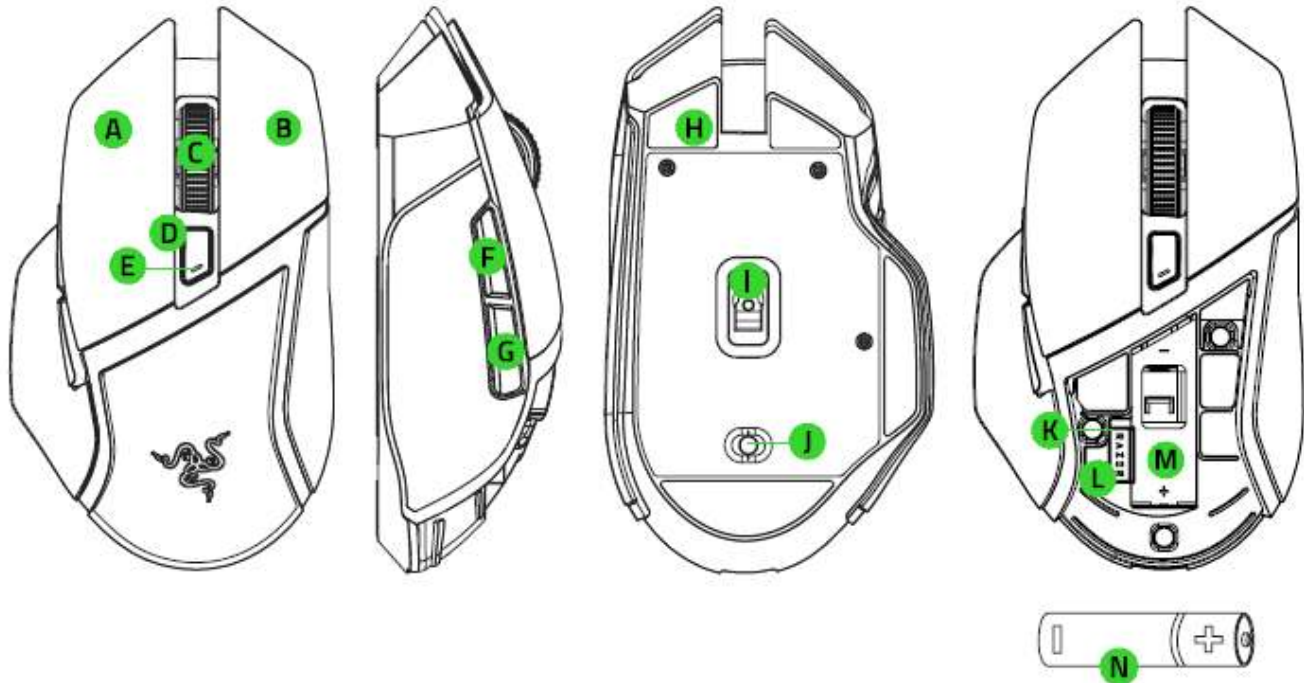

- A. Left mouse button
- B. Right mouse button
- C. Scroll wheel
- D. Cycle DPI stage up
- E. Status indicator
- F. Mouse button 5
- G. Mouse button 4
- H. Ultraslick mouse feet
- I. True 16,000 DPI 5G optical sensor
- J. Mode slider
 - Bluetooth mode
 - Power off mode
 - 2.4 GHz mode
- K. Wireless USB dongle compartment
- L. Wireless USB dongle
- M. Battery compartment
- N. AA battery

i Default DPI stages are as follows: 800, 1800, 3600, 7200, and 16000. The DPI stages can be customized using Razer Synapse 3.

2. WHAT'S NEEDED

PRODUCT REQUIREMENTS

- PC with a free USB port or Bluetooth 4.0 connectivity

RAZER SYNAPSE REQUIREMENTS

- Windows® 7 64-bit (or higher)
- Internet connection
- 500 MB of free hard disk space

3. LET'S GET YOU COVERED

You've got a great device in your hands complete with a 2-year limited warranty coverage. Now maximize its potential and score exclusive Razer benefits by registering at razerid.razer.com

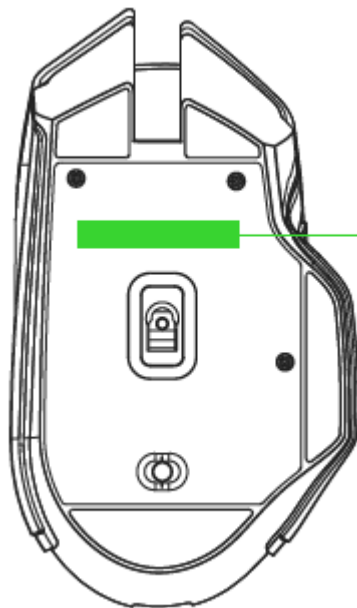

*Your product's serial number
can be found here.*

4. TECHNICAL SPECIFICATIONS

TECHNICAL SPECIFICATIONS

- Razer HyperSpeed Wireless technology
- Razer™ 5G Advanced Optical Sensor
- Ultra-Long Battery Life
- Razer™ Mechanical Mouse Switches
- 6 Programmable Buttons
- Razer 5G Advanced Optical Sensor with true 16,000 DPI
- Up to 450 inches per second (IPS) / 40 G acceleration
- HyperSpeed wireless technology (using 2.4GHz Dongle)
- Dual-mode wireless (2.4GHz and BLE)
- Six independently programmable buttons
- Razer™ Mechanical Mouse Switches rated for 50M clicks
- Ergonomic right-handed design
- Gaming-grade tactile scroll wheel
- On-The-Fly Sensitivity Adjustment (Default stages: 800/1800/3600/7200/16000)
- On-board DPI and keymap storage
- Razer Synapse 3 enabled
- Battery life: Up to 285 hours (2.4GHz), 450 hrs (BLE) with included AA battery

APPROXIMATE SIZE & WEIGHT

- Length: 130 mm / 5.12 in
- Width: 60 mm / 2.36 in
- Height: 42 mm / 1.65 in
- Weight: 83 g / 2.9 oz

5. GETTING STARTED

INSERTING THE BATTERY

1. Remove the top cover of the Razer Basilisk X HyperSpeed.

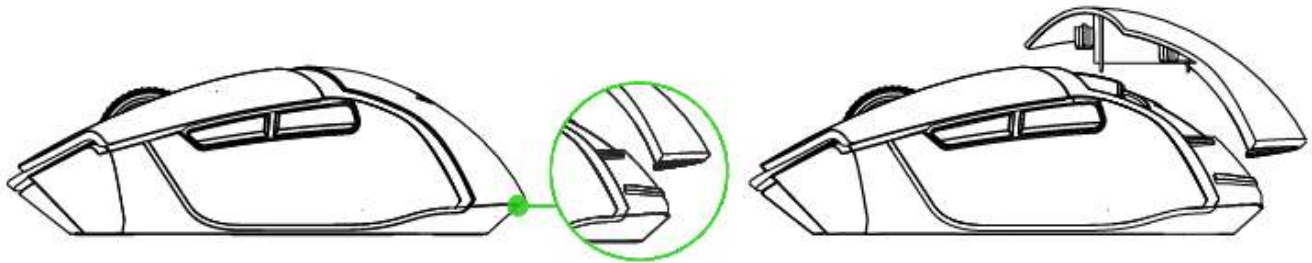

2. Insert the included AA battery into the Razer Basilisk X HyperSpeed following the directions indicated on the battery compartment.

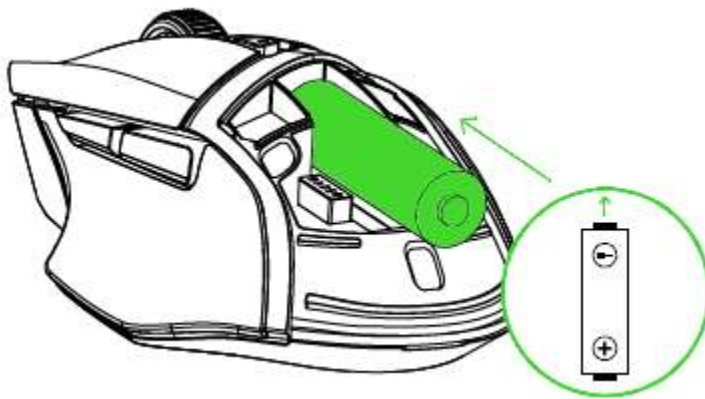

Caution: The included AA battery is non-rechargeable. Dispose of this battery in accordance with your local environmental laws. For your safety, only use an alkaline battery.

3. Reattach the top cover onto the Razer Basilisk X HyperSpeed and make sure that it is tightly secured.

i It is highly recommended to remove the battery from the mouse if you are not intending to use it for a prolonged period of time.

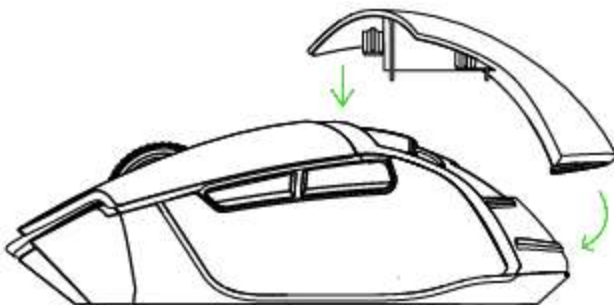

LOW BATTERY NOTIFICATION

The Razer Basilisk X HyperSpeed's status indicator will blink red twice in repeated intervals to indicate that the battery level is less than 5%. This lighting sequence will repeat until the battery is fully drained. Once you receive this notification, it is time to replace the battery.

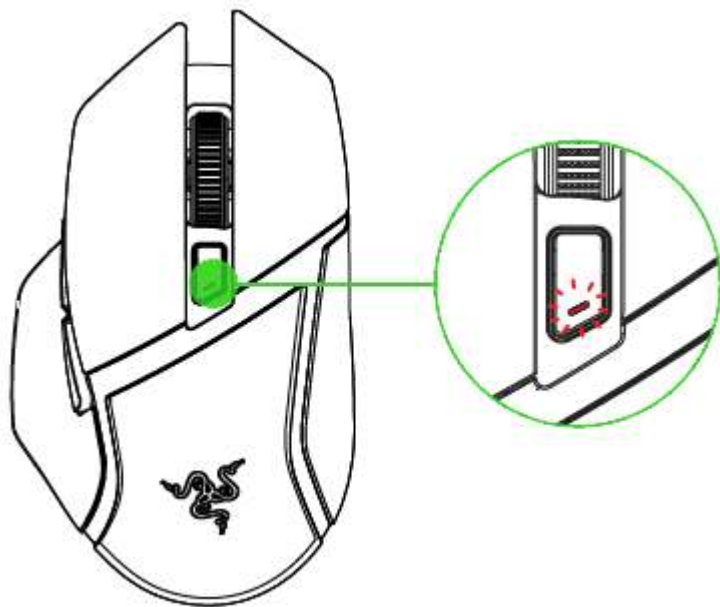

CONNECTING THE RAZER BASILISK X HYPER SPEED VIA 2.4 GHZ MODE

4. Remove the top cover of the Razer Basilisk X HyperSpeed and take the wireless USB dongle.

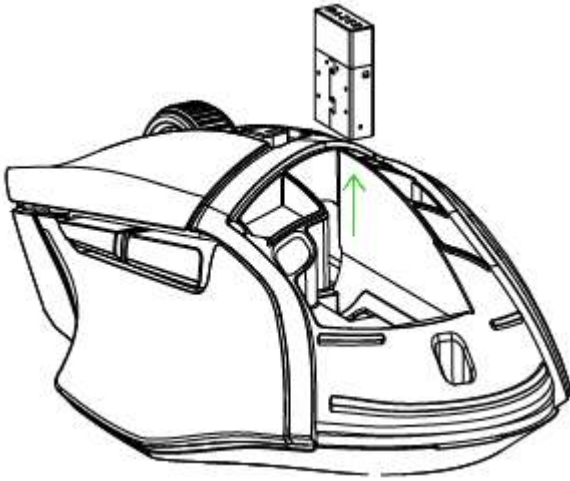

5. Close the top cover and connect the wireless USB dongle to the USB port of your computer.

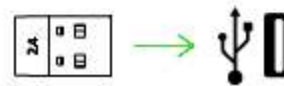
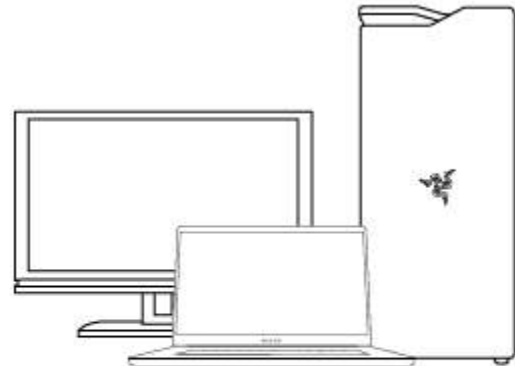

6. Switch the slider to 2.4 GHz mode. The status indicator will start blinking rapidly.

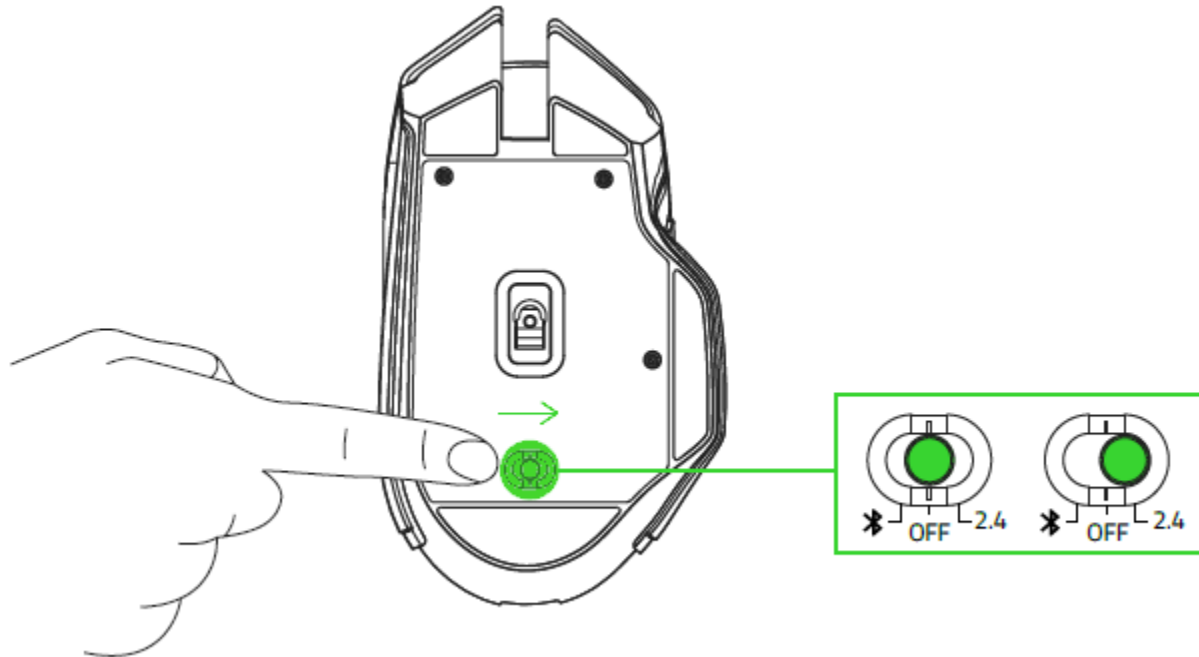

7. Wait until the mouse automatically pairs with the wireless USB dongle. When paired, the status indicator will change to static blue for 5 seconds before turning off.

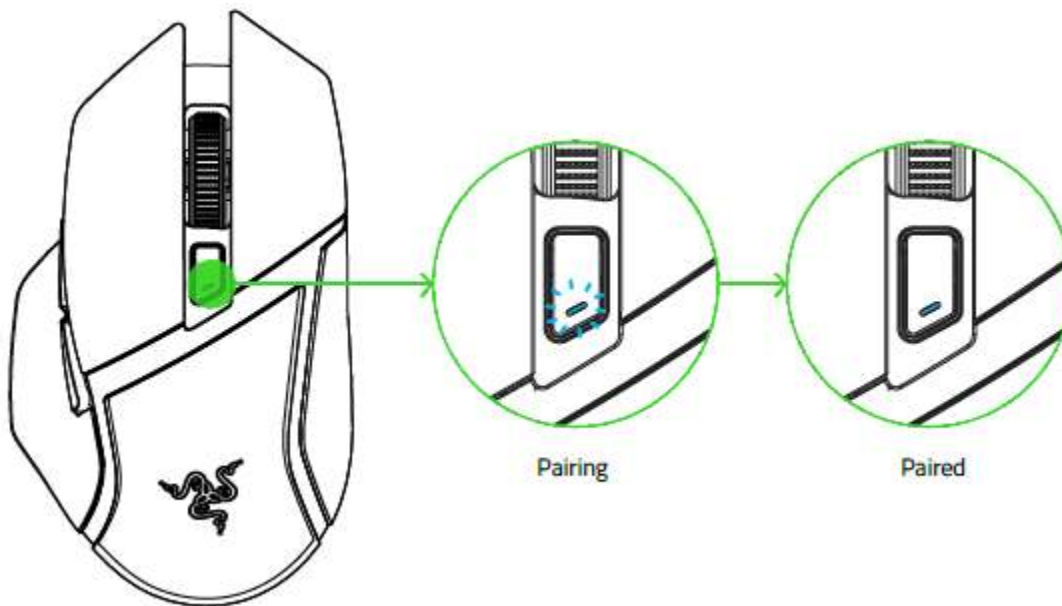

i *Keep the pairing devices within close proximity of each other for a faster and more stable connection. Install Razer Synapse when prompted or download the installer from razer.com/synapse*

Congratulations, your Razer Basilisk X HyperSpeed is now ready to use in 2.4 GHz mode.

CONNECTING THE RAZER BASILISK X HYPERSPEED VIA BLUETOOTH MODE

8. Switch the slider to Bluetooth mode (*).

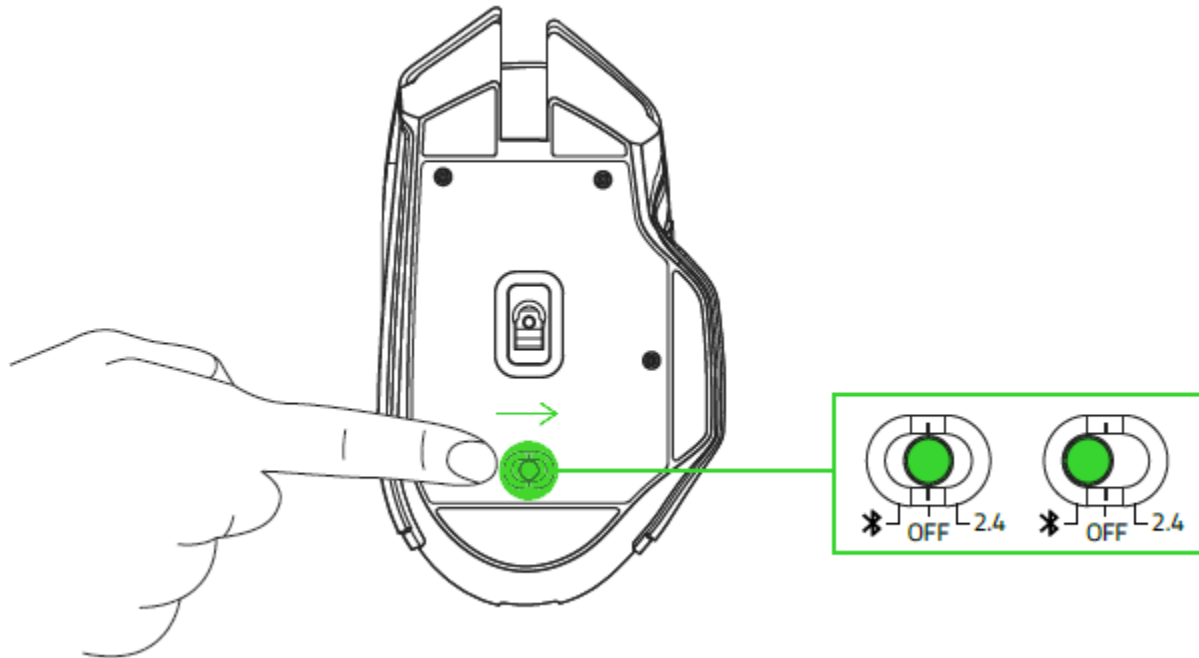

9. Press and hold the two side buttons and the cycle DPI stage up button simultaneously for three seconds to activate pairing mode. The status indicator will blink twice in repeated intervals to show that the device is in pairing mode.

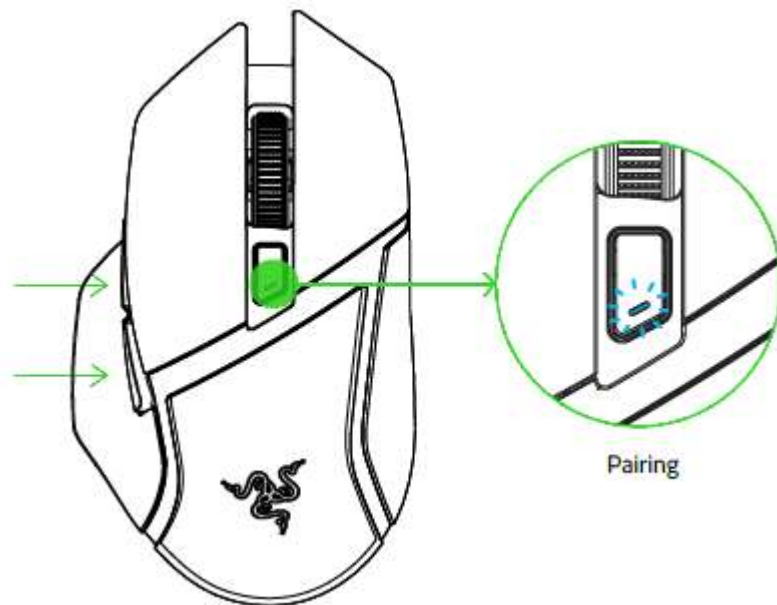

10. Activate Bluetooth on your device and search for "Razer Basilisk X HyperSpeed" from the list of devices found.

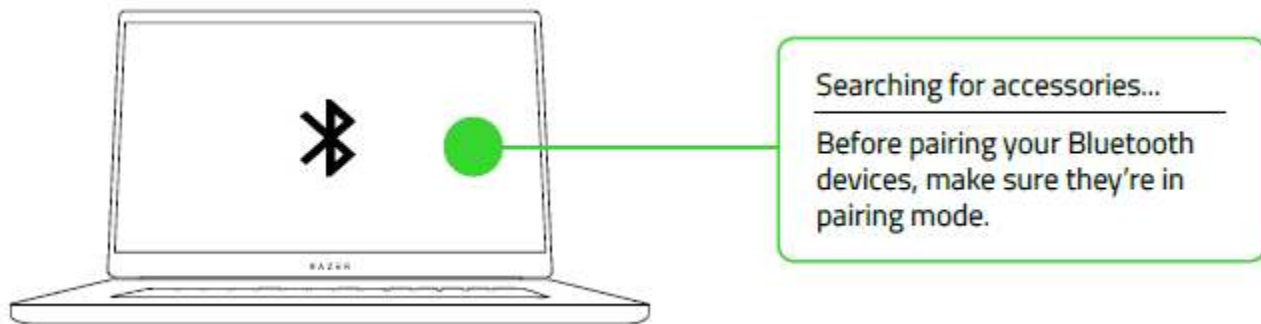

11. Wait until both devices are paired. When paired, the status indicator will change to static blue for 2 seconds before turning off.

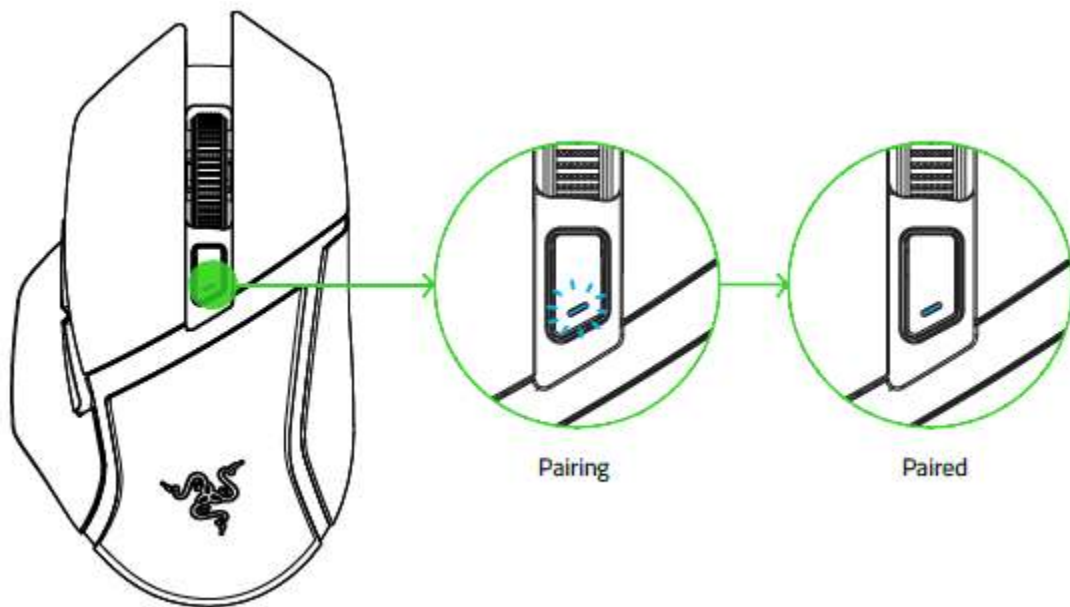

i Keep the pairing devices within close proximity of each other for faster and more stable connection.

Once both devices have been paired, your Razer Basilisk X HyperSpeed will automatically reconnect to the device whenever it is in Bluetooth mode and the device is within range.

Congratulations, your Razer Basilisk X HyperSpeed is now ready to use in Bluetooth mode.

6. SAFETY AND MAINTENANCE

SAFETY GUIDELINES

In order to achieve maximum safety while using your Razer Basilisk X HyperSpeed, we suggest that you adopt the following guidelines:

Should you have trouble operating the device properly and troubleshooting does not work, unplug the device and contact the Razer hotline or go to support.razer.com for assistance.

Do not take apart the device (doing so will void your warranty) and do not attempt to operate it under abnormal current loads.

Keep the device away from liquid, humidity or moisture. Operate the device only within the specific temperature range of 0°C (32°F) to 40°C (104°F). Should the temperature exceed this range, unplug and/or switch off the device in order to let the temperature stabilize to an optimal level.

COMFORT

Research has shown that long periods of repetitive motion, improper positioning of your computer peripherals, incorrect body position, and poor habits may be associated with physical discomfort and injury to nerves, tendons, and muscles. Below are some guidelines to avoid injury and ensure optimum comfort while using your Razer Basilisk X HyperSpeed.

- Position your keyboard and monitor directly in front of you with your mouse next to it. Place your elbows next to your side, not too far away and your keyboard within easy reach.
- Adjust the height of your chair and table so that the keyboard and mouse are at or below elbow-height.
- Keep your feet well supported, posture straight and your shoulders relaxed.
- During gameplay, relax your wrist and keep it straight. If you do the same tasks with your hands repeatedly, try not to bend, extend or twist your hands for long periods.
- Do not rest your wrists on hard surfaces for long periods. Use a wrist rest to support your wrist while gaming.
- Customize the keys on your keyboard to suit your style of gaming in order to minimize repetitive or awkward motions while gaming.
- Do not sit in the same position all day. Get up, step away from your desk and do exercises to stretch your arms, shoulders, neck and legs.

If you should experience any physical discomfort while using your mouse, such as pain, numbness, or tingling in your hands, wrists, elbows, shoulders, neck or back, please consult a qualified medical doctor immediately.

MAINTENANCE AND USE

The Razer Basilisk X HyperSpeed requires minimum maintenance to keep it in optimum condition. Once a month we recommend you unplug the device from the computer and clean it using a soft cloth or cotton swab with a bit of warm water to prevent dirt buildup. Do not use soap or harsh cleaning agents.

To get the ultimate experience in movement and control, we highly recommend a premium mouse mat from Razer. Some surfaces will cause undue wear on the feet requiring constant care and eventual replacement.

Do note that the sensor of the Razer Basilisk X HyperSpeed is 'tuned' or optimized especially for the Razer mouse mats. This means that the sensor has been tested extensively to confirm that the Razer Basilisk X HyperSpeed reads and tracks best on Razer mouse mats.

7. LEGALESE

COPYRIGHT AND INTELLECTUAL PROPERTY INFORMATION

©2019 Razer Inc. All rights reserved. Razer, the triple-headed snake logo, Razer logo, "For Gamers. By Gamers.", and "Powered by Razer Chroma" logo are trademarks or registered trademarks of Razer Inc. and/or affiliated companies in the United States or other countries. All other trademarks and trade names are the property of their respective owners and other company and product names mentioned herein may be trademarks of their respective companies.

Windows and the Windows logo are trademarks or registered trademarks of the Microsoft group of companies.

Razer Inc. ("Razer") may have copyright, trademarks, trade secrets, patents, patent applications, or other intellectual property rights (whether registered or unregistered) concerning the product in this guide. Furnishing of this guide does not give you a license to any such copyright, trademark, patent or other intellectual property right. The Razer Basilisk X HyperSpeed (the "Product") may differ from pictures whether on packaging or otherwise. Razer assumes no responsibility for such differences or for any errors that may appear. Information contained herein is subject to change without notice.

LIMITED PRODUCT WARRANTY

For the latest and current terms of the Limited Product Warranty, please visit [razer.com/warranty](https://www.razer.com/warranty).

LIMITATION OF LIABILITY

Razer shall in no event be liable for any lost profits, loss of information or data, special, incidental, indirect, punitive or consequential or incidental damages, arising in any way out of distribution of, sale of, resale of, use of, or inability to use the Product. In no event shall Razer's liability exceed the retail purchase price of the Product.

GENERAL

These terms shall be governed by and construed under the laws of the jurisdiction in which the Product was purchased. If any term herein is held to be invalid or unenforceable, then such term (in so far as it is invalid or unenforceable) shall be given no effect and deemed to be excluded without invalidating any of the remaining terms. Razer reserves the right to amend any term at any time without notice.