

# INTERLINE

## INTERLINE BALI 7,90 x 4,00m

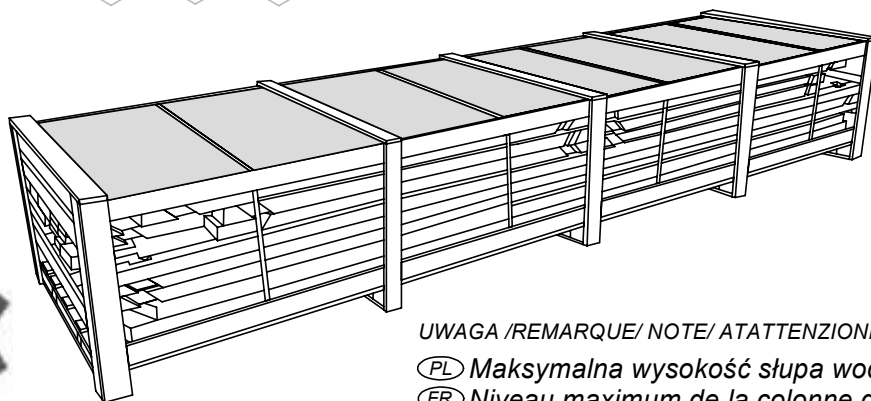
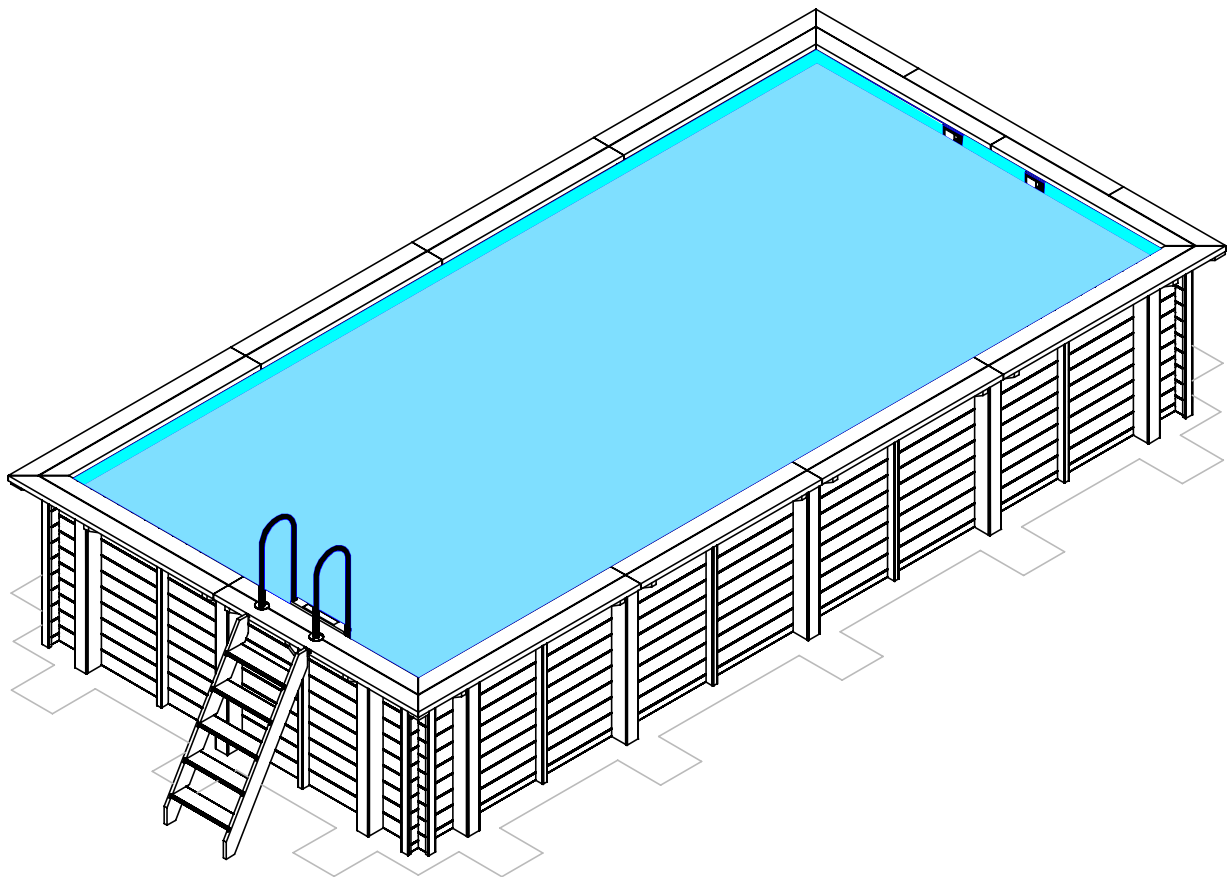

**5 years**

Wood warranty

- PL** Instrukcja montażu
- FR** Notice de montage
- GB** Assembly instructions
- IT** Istruzioni di montaggio
- DE** Montageanleitungen
- NL** Montage-instructies

UWAGA /REMARQUE/ NOTE/ ATATTENZIONE /HINWEIS /LETOP

- (PL)** Maksymalna wysokość słupa wody ~ 1,20 m
- (FR)** Niveau maximum de la colonne d'eau ~ 1,20 m
- (GB)** The maximum water column level ~ 1,20 m
- (IT)** Livello massimo della colonna d'acqua ~ 1,20 m
- (DE)** Maximaler Wasserstand ~ 1,20 m
- (NL)** Maximum niveau waterkolom ~ 1,20 m

Objętość wody w basenie 25.40 m<sup>3</sup>  
Le volume de l'eau dans la piscine 25.40 m<sup>3</sup>  
Water capacity in the pool 25.40 m<sup>3</sup>  
Il volume di acqua in piscina 25.40 m<sup>3</sup>  
Wasserkapazität im Pool 25.40 m<sup>3</sup>  
Watercapaciteit in het zwembad 25.40 m<sup>3</sup>

**(PL)** Instrukcja montażu

**(GB)** Assembly instructions

**(DE)** Montageanleitung

**(FR)** Notice de montage

**(IT)** Istruzioni di montaggio

**(NL)** Montage-instructies



**(PL)** Przed przystąpieniem do montażu zapoznaj się z instrukcją.

**(FR)** Avant le montage lisez attentivement la notice.

**(GB)** Read carefully pool installation manual before the installation.

**(IT)** Prima del montaggio é necessario consultare il manuale.

**(DE)** Lesen Sie das Pool-Installationshandbuch vor der Installation sorgfältig durch.

**(NL)** Lees zorgvuldig de handleiding van het zwembad voordat u met de installatie begint.

## **UWAGA / REMARQUE / NOTE / ATATTENZIONE / HINWEIS / OPMERKING**

*Instrukcja, którą posiadacie Państwo w ręku pokazuje krok po kroku w jaki sposób dokonać właściwego montażu basenu. Dołożyliśmy wszelkich starań, aby przygotować materiały jak najbardziej odzwierciedlające stan faktyczny i wygląd poszczególnych elementów. Jednak proszę pamiętać, że wszelkie rysunki mają charakter poglądowy i istnieje możliwość, że poszczególne elementy dostarczone w Państwa zestawie w rzeczywistości mogą odbiegać wyglądem od ich wizualizacji graficznej zawartej w instrukcji.*

**(PL)**

*Le manuel que vous avez entre les mains montre étape par étape comment assembler correctement la piscine. Nous avons fait tous les efforts pour préparer les documents reflétant autant que possible l'état réel et l'apparence des éléments particuliers. Pourtant, il faut savoir que tous les dessins sont présentés à titre de référence et qu'il est possible que les éléments singuliers fournis dans votre kit puissent différer en apparence de leur visualisation graphique incluse dans le manuel.*

**(FR)**

*This manual presents the correct assembly procedure for the swimming pool, step by step. We have undertaken all possible efforts to make sure that the materials are as close to the actual items and present their layout as closely as possible. Please remember, however, that all figures are indicative only and individual elements delivered in your set may be different than their graphical visualisations presented in the manual.*

**(GB)**

*Le presenti istruzioni spiegano passo dopo passo come montare correttamente la piscina. Abbiamo fatto del nostro meglio per preparare i materiali che rispecchiano il più fedelmente possibile lo stato reale e l'aspetto dei singoli elementi. Occorre però ricordare che le figure hanno carattere illustrativo ed è possibile che i singoli elementi forniti nel Vostro kit avranno l'aspetto diverso dalla loro visualizzazione grafica contenuta nelle istruzioni.*

**(IT)**

*Die Ihnen vorliegende Anleitung erläutert Ihnen Schritt für Schritt, wie das Schwimmbecken korrekt montiert wird. Wir haben alles daran gesetzt, die Unterlagen bestmöglich an den tatsächlichen Zustand und das Aussehen der einzelnen Teile anzupassen. Bitte bedenken Sie jedoch, dass alle Zeichnungen nur zu Anschauungszwecken dienen. Deshalb kann es sein, dass einzelne Teile in Ihrem Set anders aussehen, als in der graphischen Visualisierung in der Anleitung.*

**(DE)**

*Deze handleiding presenteert stap voor stap hoe u het zwembad op de juiste manier kunt monteren. We hebben er alles aan gedaan om een handleiding te maken die een realistisch beeld weergeeft van de montage en onderdelen.*

**(NL)**

*Houd echter wel rekening mee dat alle tekeningen alleen ter referentie dienen en dat het mogelijk is dat de afzonderlijke elementen in uw set kunnen afwijken van de grafische tekeningen in deze handleiding.*

**(PL)** Instrukcja montażu

**(GB)** Assembly instructions

**(DE)** Montageanleitung

**(FR)** Notice de montage

**(IT)** Istruzioni di montaggio

**(NL)** Montage-instructies



**(PL)** Przed przystąpieniem do montażu zapoznaj się z instrukcją. \* Bez wylewki betonowej.

**(FR)** Avant le montage lisez attentivement la notice. \* Sans dalle de béton.

**(GB)** Read carefully pool installation manual before the installation. \* Without concrete base.

**(IT)** Prima del montaggio è necessario consultare il manuale. \* Senza una lastra di cemento.

**(DE)** Lesen Sie das Pool-Installationshandbuch vor der Installation sorgfältig durch. \* Ohne Betonbasis.

**(NL)** Lees zorgvuldig de handleiding van het zwembad voordat u met de installatie begint. \* Zonder betonnen basis.

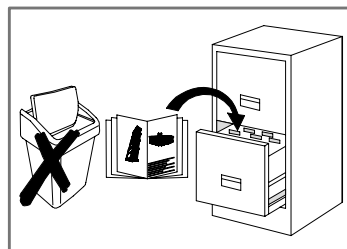
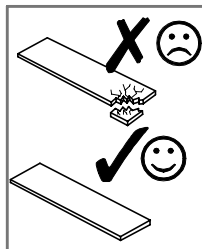
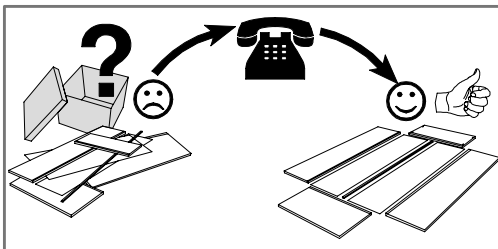
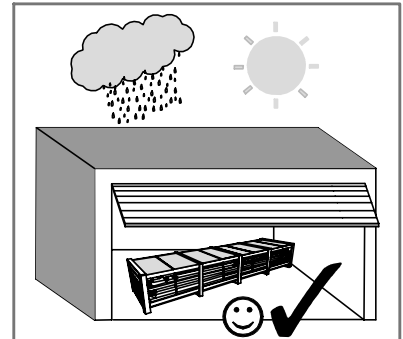
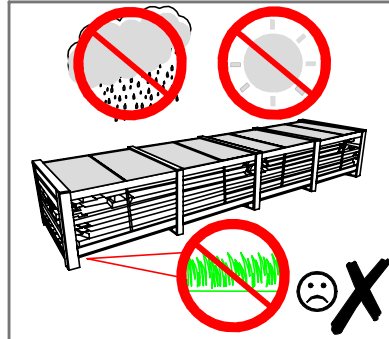
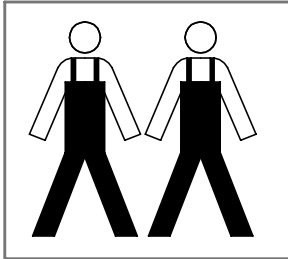
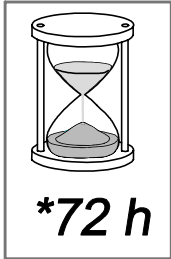

**UWAGA / REMARQUE / NOTE / ATENZIONE / HINWEIS / OPMERKING**

**(PL)** Montaż wykonać w przeciągu 3 dni od rozpakowania struktury.

**(FR)** Le montage de la structure doit être terminé dans un délai de 3 jours suivant l'ouverture de l'emballage.

**(GB)** Installation should be finished within 3 days from opening the package.

**(IT)** Il montaggio effettuare entro 3 giorni dal disimballo della struttura.

**(DE)** Die Installation sollte innerhalb von 3 Tagen nach dem Öffnen des Pakets abgeschlossen sein.

**(NL)** De installatie moet binnen 3 dagen na opening van het pakket worden voltooid.



**UWAGA / REMARQUE / NOTE / ATENZIONE / HINWEIS / OPMERKING**

**(PL)** Brak corocznej konserwacji struktury powoduje utratę gwarancji.

**(FR)** En cas de défaut d'entretien annuel de la structure, la garantie est invalidée.

**(GB)** Lack of once a year conservation of the structure causes loss of warranty.

**(IT)** Mancanza della manutenzione annuale causa la perdita di garanzia.

**(DE)** Der Mangel an einmal jährlichem Schutz der Struktur verursacht einen Garantieverlust.

**(NL)** Het uitblijven van onderhoud aan de constructie eenmaal per jaar zorgt voor verval van de garantie.



**UWAGA / REMARQUE / NOTE / ATENZIONE / HINWEIS / OPMERKING**

**(PL)** Nie pozostawiać dzieci bez nadzoru!

**(FR)** Ne laissez pas les enfants sans surveillance!

**(GB)** Do not leave children unattended!

**(IT)** Non lasciare bambini incustoditi!

**(DE)** Lassen Sie Kinder nicht unbeaufsichtigt!

**(NL)** Laat kinderen niet zonder toezicht!

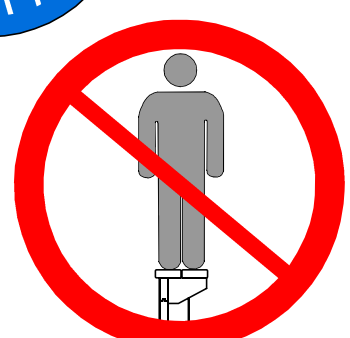
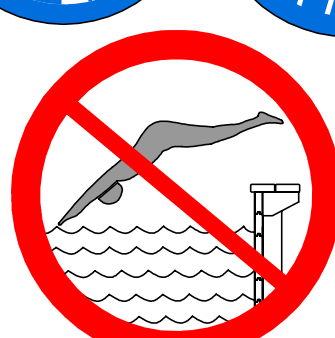

**PL** Elementy

**GB** Elements

**DE** Elemente

**FR** Les éléments

**IT** Elementi

**NL** Elementen



**PL** Sprawdź ilość oraz czy elementy nie są uszkodzone.

**FR** Vérifier que les éléments soient au complet (quantité) et qu'ils ne soient pas endommagés (qualité).

**GB** Check quantity of elements and if they are not faulty.

**IT** Controllare la quantità e se gli elementi non sono danneggiati.

**DE** Überprüfen Sie die Anzahl der Elemente und ob sie nicht fehlerhaft sind.

**NL** Controleer de hoeveelheid elementen en of deze niet defect zijn.

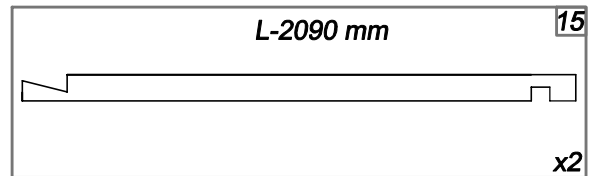
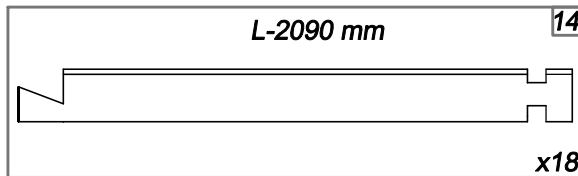
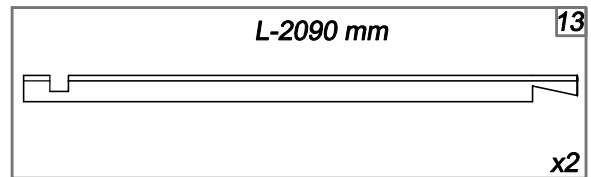
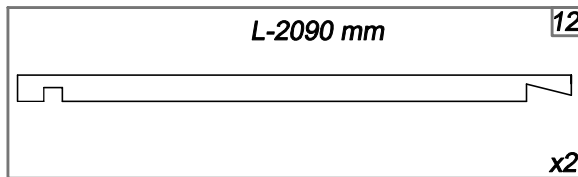
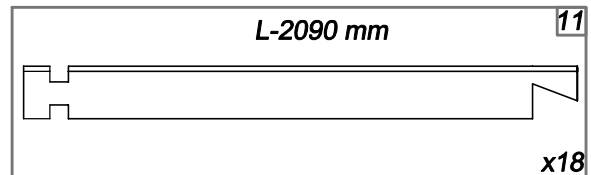
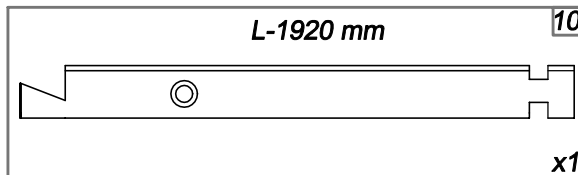
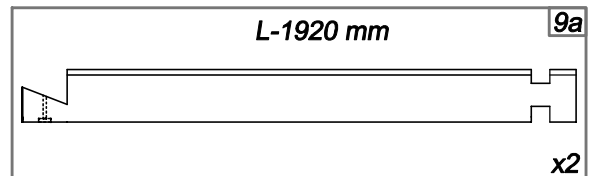
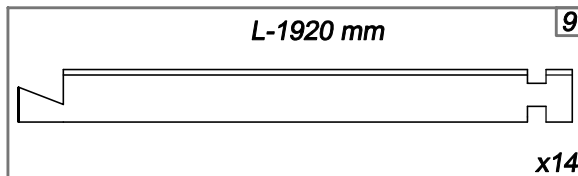
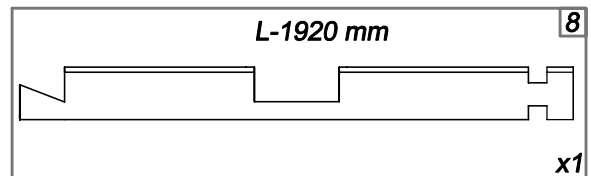
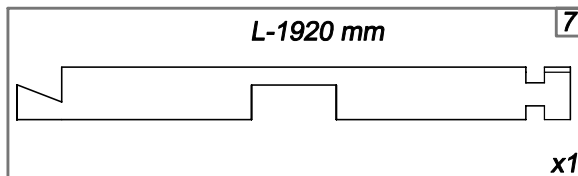
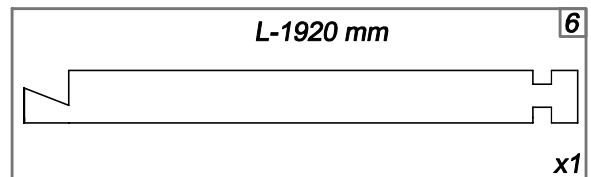
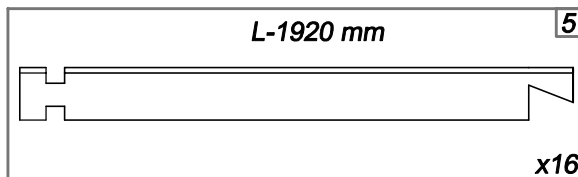
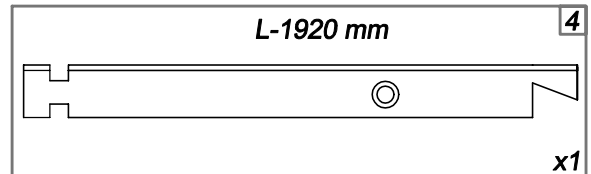
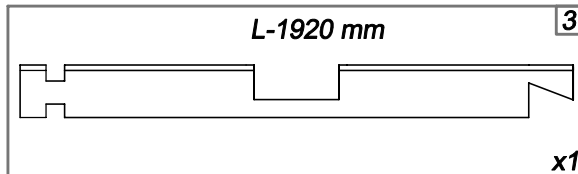
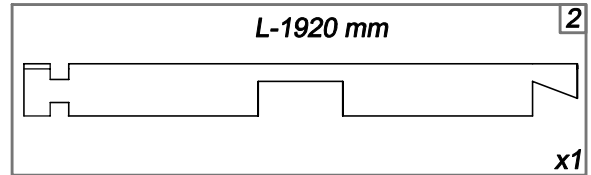
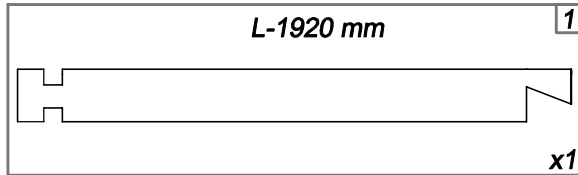
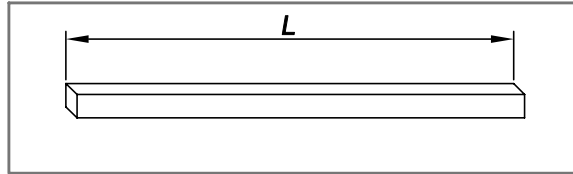

**PL** Elementy

**GB** Elements

**DE** Elemente

**FR** Les éléments

**IT** Elementi

**NL** Elementen



**PL** Sprawdź ilość oraz czy elementy nie są uszkodzone.

**FR** Vérifier que les éléments soient au complet (quantité) et qu'ils ne soient pas endommagés (qualité).

**GB** Check quantity of elements and if they are not faulty.

**IT** Controllare la quantità e se gli elementi non sono danneggiati.

**DE** Überprüfen Sie die Anzahl der Elemente und ob sie nicht fehlerhaft sind.

**NL** Controleer de hoeveelheid elementen en of deze niet defect zijn.

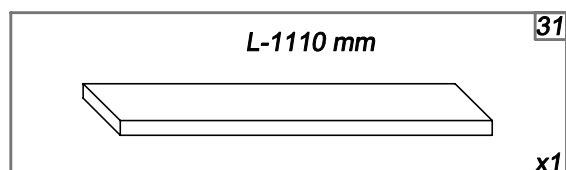
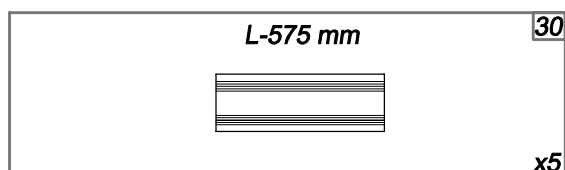
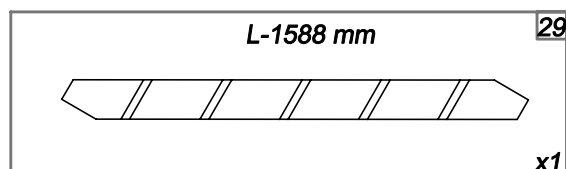
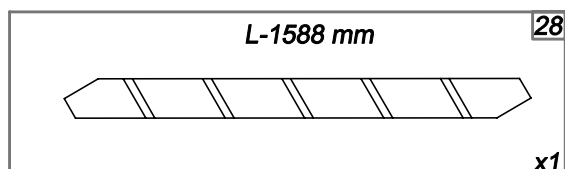
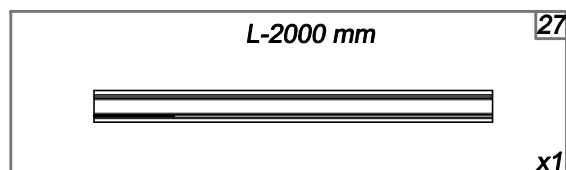
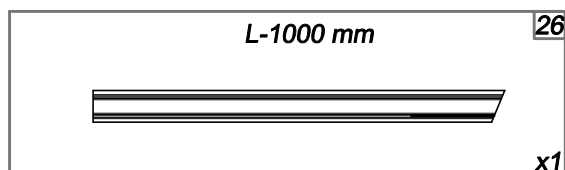
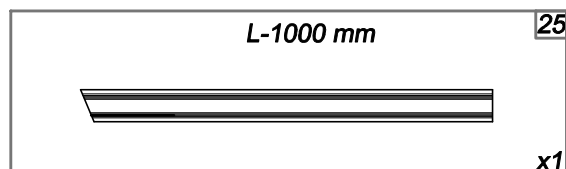
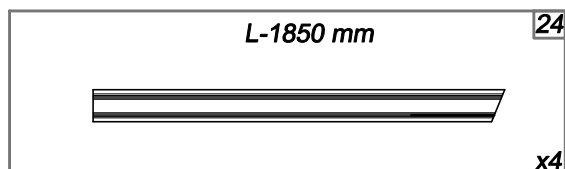
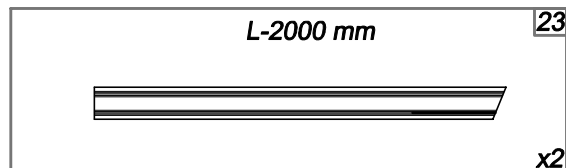
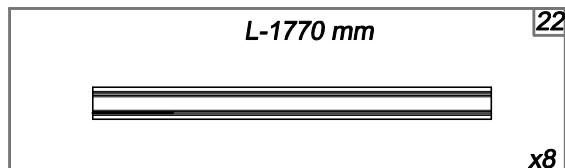
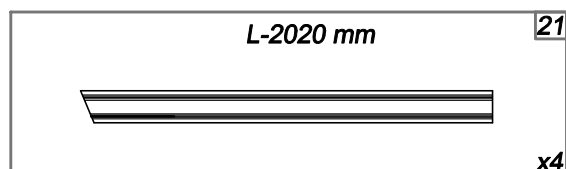
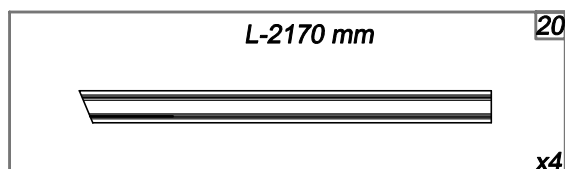
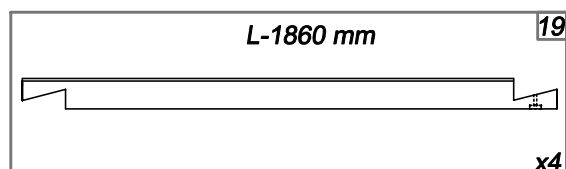
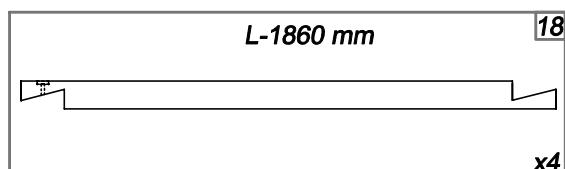
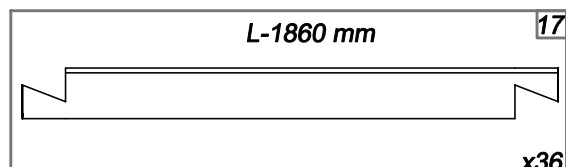
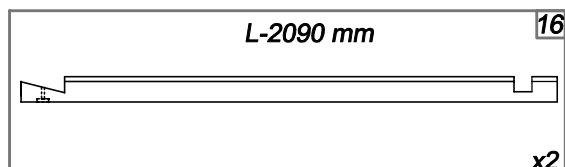
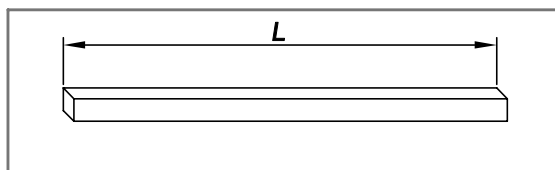

**PL** Elementy

**GB** Elements

**DE** Elemente

**FR** Les éléments

**IT** Elementi

**NL** Elementen



**PL** Sprawdź ilość oraz czy elementy nie są uszkodzone.

**FR** Vérifier que les éléments soient au complet (quantité) et qu'ils ne soient pas endommagés (qualité).

**GB** Check quantity of elements and if they are not faulty.

**IT** Controllare la quantità e se gli elementi non sono danneggiati.

**DE** Überprüfen Sie die Anzahl der Elemente und ob sie nicht fehlerhaft sind.

**NL** Controleer de hoeveelheid elementen en of deze niet defect zijn.

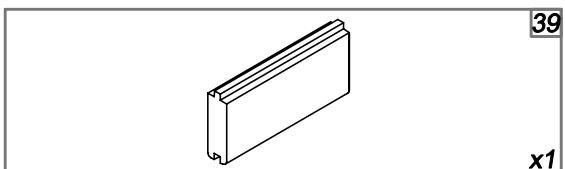
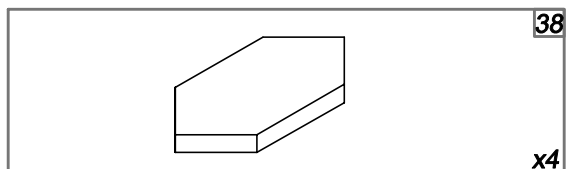
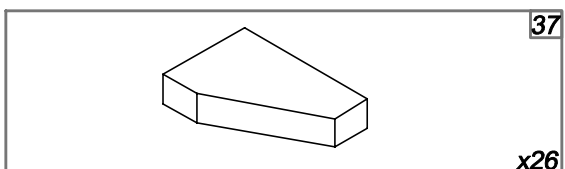
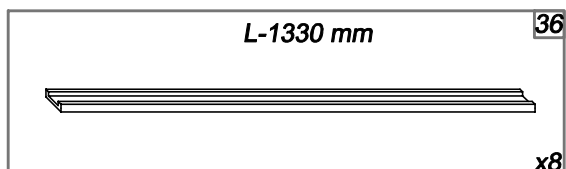
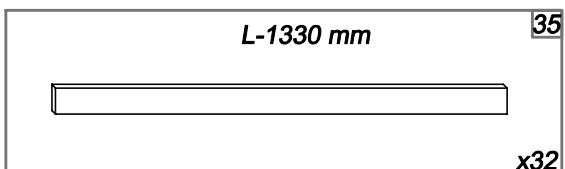
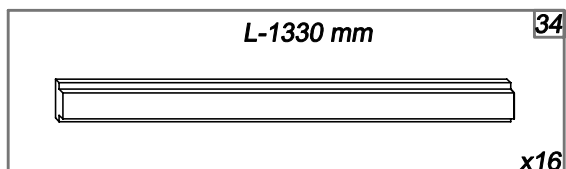
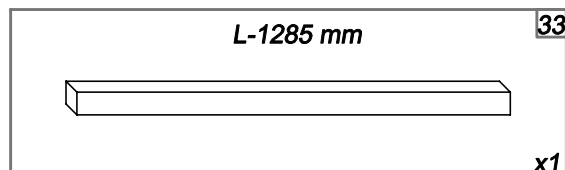
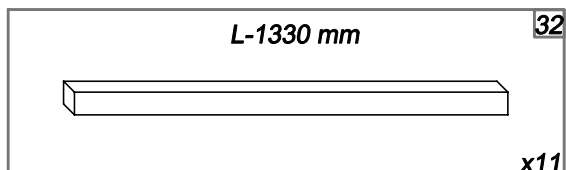
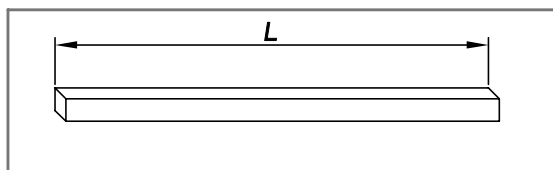

**PL** Okucia i osprzęt

**GB** Fittings and equipment

**DE** Ausstattung und Ausrüstung

**FR** Quincaillerie et équipement

**IT** Ferramenti e accessori

**NL** Fittingen en apparatuur



**PL** Sprawdź ilość.

**FR** Vérifiez la quantité.

**GB** Check quantity.

**IT** Controllare la quantità.

**DE** Überprüfen Sie die Anzahl.

**NL** Controleer de hoeveelheid.

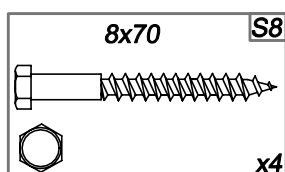
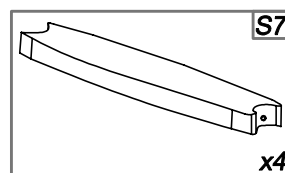
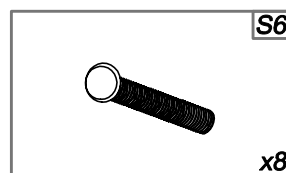
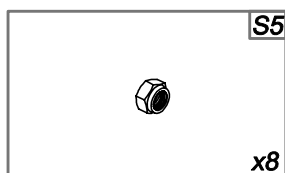
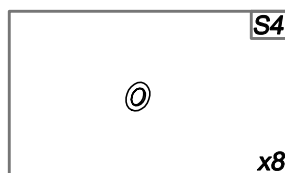
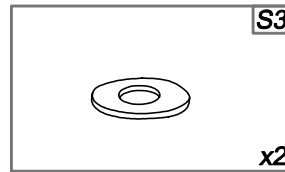
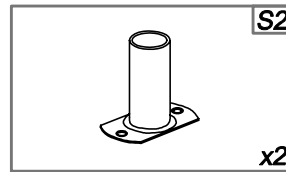
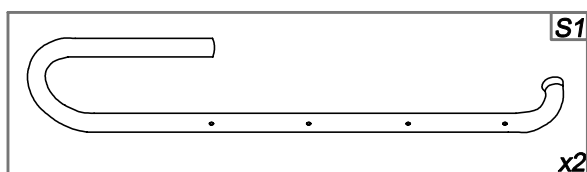
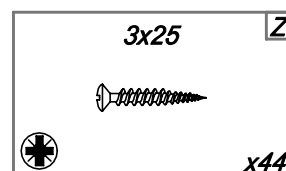
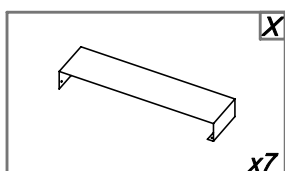
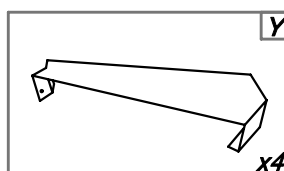
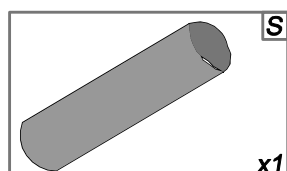
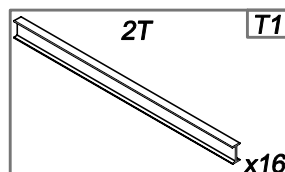
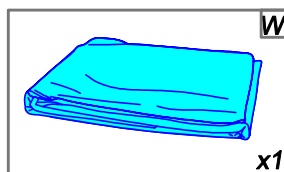
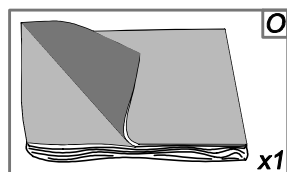
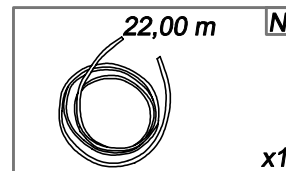
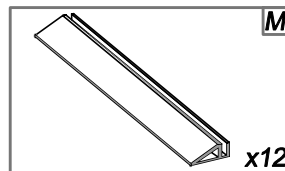
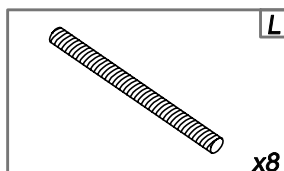
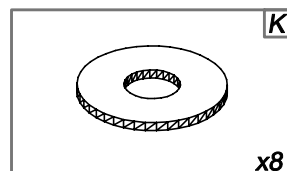
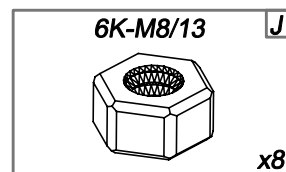
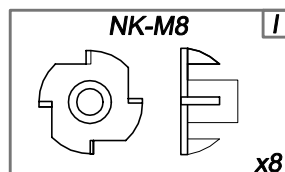
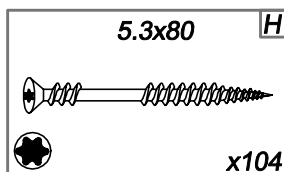
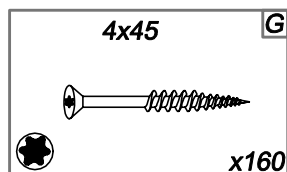
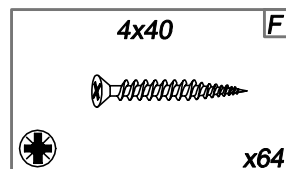
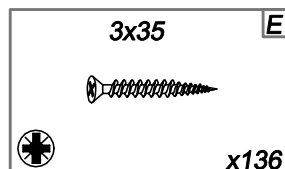
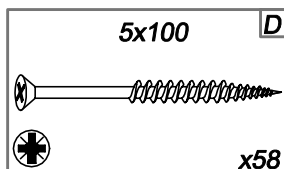
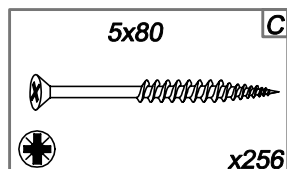
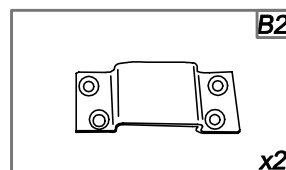
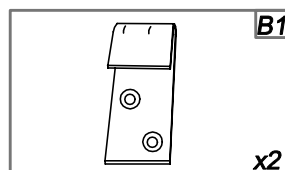
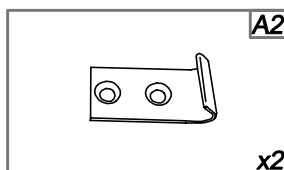
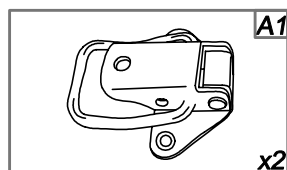

**(PL) Skimmer i dysze**

**(GB) Skimmer and nozzles**

**(DE) Skimmer und Düsen**

**(FR) Le skimmer et la buse de refoulement**

**(IT) Skimmer e ugelli**

**(NL) Skimmer en jet straal**



**(PL) Sprawdź ilość.**

**(FR) Vérifiez la quantité.**

**(GB) Check quantity.**

**(IT) Controllare la quantità.**

**(DE) Überprüfen Sie die Anzahl.**

**(NL) Controleer de hoeveelheid.**

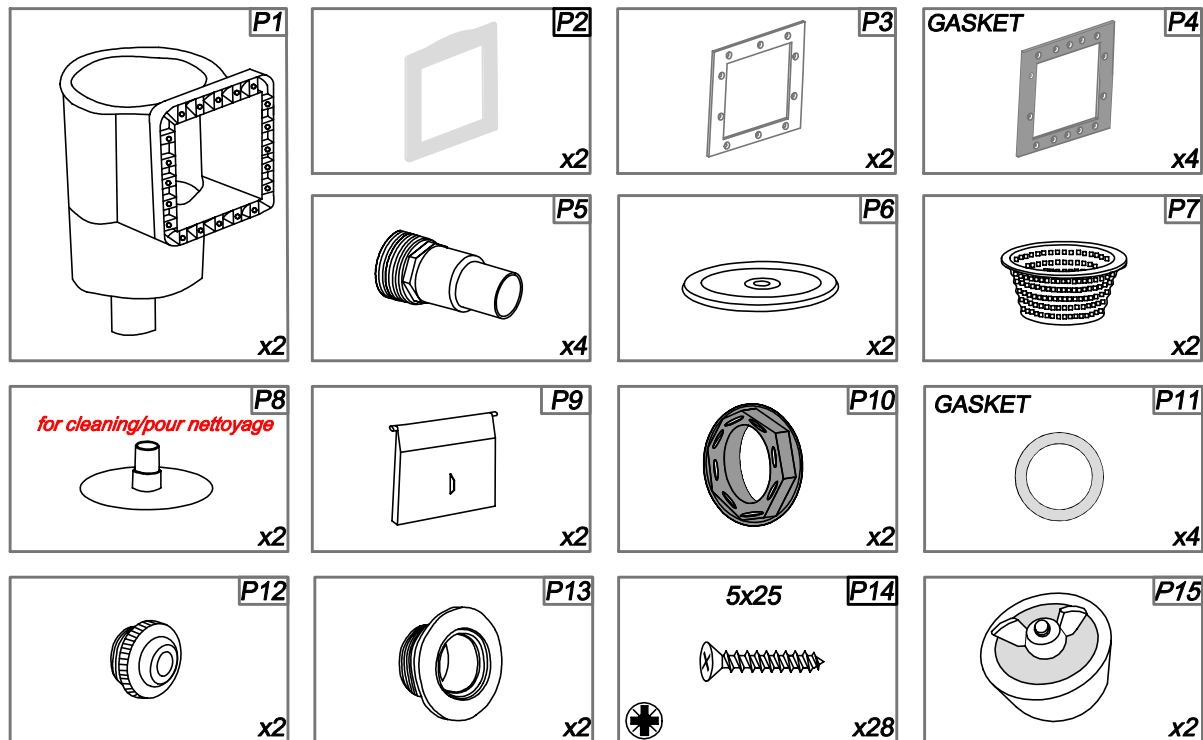

**UWAGA / ATTENTION / NOTE / ATATTENZIONE / HINWEIS / OPMERKING**

**(PL)** Poszczególne elementy osprzętu w instrukcji mogą się nieznacznie różnić od faktycznie dostarczonych.

**(FR)** Il est possible que certains éléments présentés dans la notice de montage ne soient pas exactement identiques aux éléments livrés.

**(GB)** It is possible that some elements of equipment in the assembly instruction will not correspond exactly to those supplied

**(IT)** E possibile che degli elementi di attrezzatura nell'istruzione di riunione non corrisponderanno precisamente ad elementi approvigionati.

**(DE)** Es ist möglich, dass einige Elemente der Ausrüstung in der Montageanleitung nicht genau mit den gelieferten übereinstimmen.

**(NL)** Het is mogelijk dat sommige apparatuuronderdelen in de montage-instructie niet precies overeenkomen met de geleverde onderdelen.

**UWAGA / REMARQUE / NOTE / ATATTENZIONE / HINWEIS / OPMERKING**

**(PL)** Widok po zmontowaniu.

**(FR)** Controlez après montage.

**(GB)** View after assembly.

**(IT)** Vista dopo il montaggio.

**(DE)** Ansicht nach der Montage.

**(NL)** Controleer na de montage.

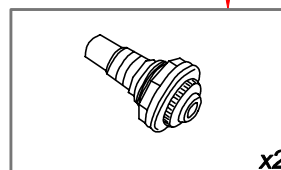
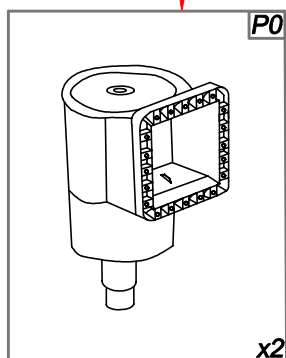



**(PL) Opcja**  
**(FR) Option**

**(GB) Option**  
**(IT) Opzione**

**(DE) Option**  
**(NL) Optie**



**(PL)** Zatyczka do dyszy – w celu przygotowania basenu do sezonu zimowego ( w szczególności przy ryzyku zamarznięcia wody), zastosuj zatyczkę do dysz napływowych, odcinając dopływ wody do zestawu filtracyjnego. **Pozostaw dyszę w basenie, zamontuj zatyczkę pod wodą.** Należy pamiętać również o odłączeniu zestawu filtracyjnego od źródła wody i dokładnym osuszeniu dyszy od strony zewnętrznej. Zaleca się także, aby z pompy jak i dołączonego filtra piaskowego na okres zimy (miejsca gdzie występują mrozy) usunąć pozostałości wody, w innym przypadku zamarzająca woda może dokonać zniszczenia całości zestawu.

**(FR)** Bouchon pour la buse de refoulement – afin de préparer la piscine pour l'hiver (en particulier en cas de risque de gel de l'eau), veuillez utiliser le bouchon spécialement fourni avec le skimmer et destiné à fermer l'accès de l'eau au système de filtration. **Veuillez laisser la buse de refoulement dans la piscine, montez le bouchon sous l'eau.** Il est également indispensable de déconnecter le système de filtration du point d'arrivée d'eau et de s'assurer que la partie de la buse de refoulement placée à l'extérieur de la piscine soit parfaitement sèche. En plus, il est conseillé de vider le reste de l'eau se trouvant dans la pompe et le filtre à sable surtout en période de gel. L'eau qui gèle à l'intérieur du système de filtration peut causer des dégâts et des dysfonctionnements.

**(GB)** Rubber plug- in order to prepare the pool for the winter season (especially if there is a risk of freezing) put a plug into the inlet to shut off the access of water to the filtration system. **Inlet must remain in the pool. Fix the plug under water.** Remember to disconnect the filtration set from the pool and dry the inlet (the part of inlet which is outside of the pool). For the winter season, it is recommended to get rid of water remaining in pump and sand filter, otherwise freezing water can cause devastation of the whole set.

**(DE)** Stöpsel für die Düse – den Pool für die Wintersaison vorbereiten (insbesondere wegen der Gefahr des einfrierenden Wassers), verwenden Sie dazu die Zuflusssdüse. Schneiden Sie die Wasserzufuhr zu dem Filtersystem ab, nachdem Sie den Filter abgetrennt haben, sollten Sie auf die gründliche Trocknung der Düse von außen achten, und dass die Filteranlage von der Wasserquelle abgetrennt ist. **Lassen Sie die Düse in den Pool, installieren Sie den Stöpsel unter dem Wasser.** Es wird auch empfohlen, aus dem Sandfilter sowie der Pumpe restliches Wasser zu entfernen (Stellen wo Frost entstehen kann), da sonst das gefrierende Wasser das komplette Filtersystem beschädigt.

**(NE)** Rubberen stop - om de toegang van de inlaat (jet straal) voor het filtersysteem af te sluiten ter voorbereiding op het winterseizoen (vooral als er een risico bestaat op bevriezing van water). **De inlaat moet in het zwembad blijven. Bevestig de stop onder water.** Let op dat u de het filtersysteem loskoppelt van het zwembad en de achterkant van de inlaat laat drogen en achterblijvend water te verwijderen, ter voorkoming van beschadiging in het filtersysteem door bevriezing van water.



1



3

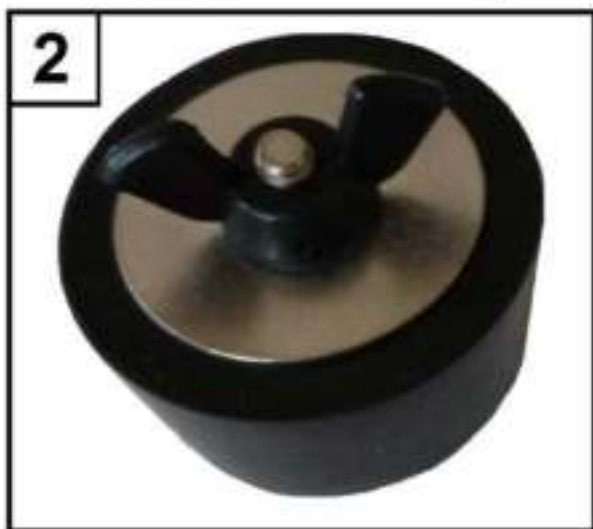

2



4

**PL** Narzędzia

**GB** Tools

**DE** Werkzeuge

**FR** Les outils

**IT** Strumenti

**NL** Gereedschap

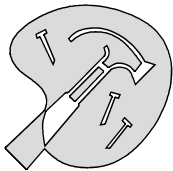

**PL** Przygotuj niezbędne narzędzia - niezawarte w zestawie.

**FR** Préparez les outils nécessaires - non inclus.

**GB** Prepare essential tools- not included.

**IT** Preparare gli strumenti necessari - non inclusi nel set.

**DE** Bereiten Sie das notwendige Werkzeug vor - nicht enthalten.

**NL** Bereid de benodigde hulpmiddelen voor - niet inbegrepen.

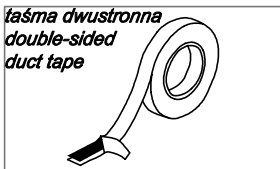
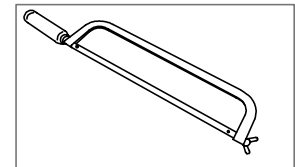
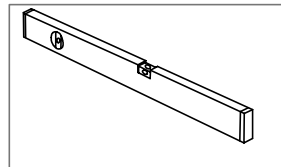
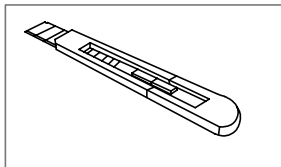
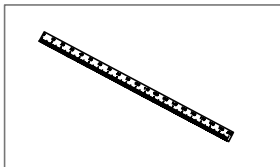
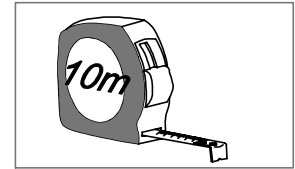
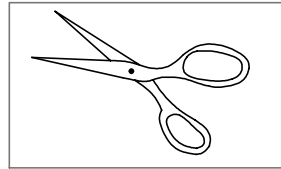
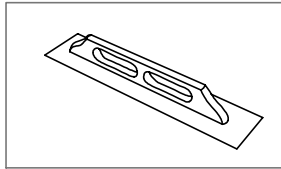
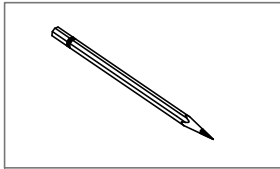

taśma dwustronna  
double-sided  
duct tape

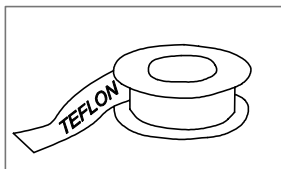

TEFLON



VASELINE

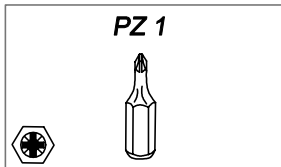
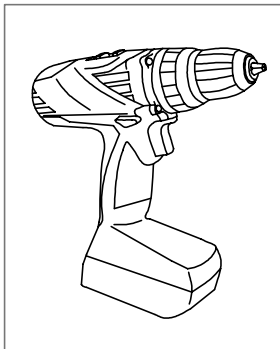
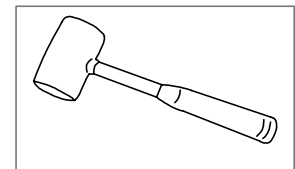

PZ 1

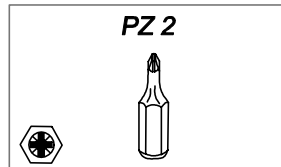

PZ 2



TORX TX20

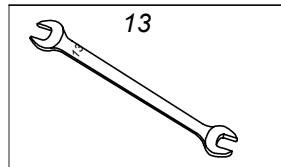
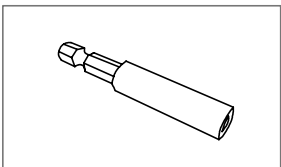

13

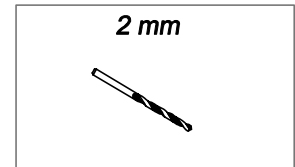

2 mm

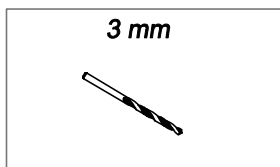

3 mm

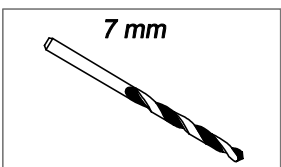

7 mm

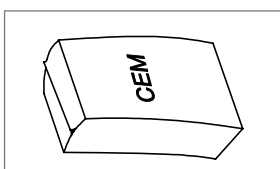
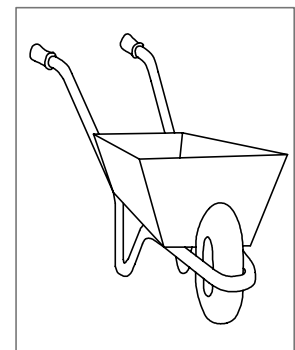
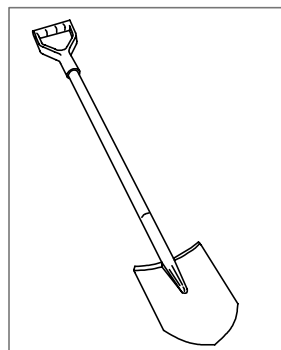
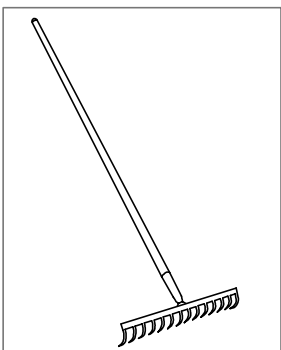
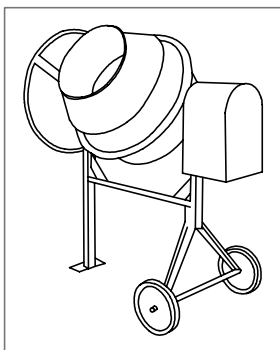
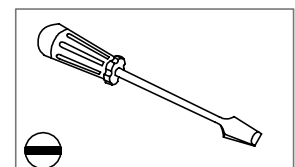
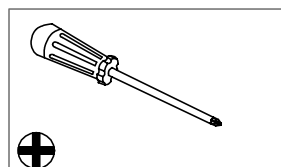

CEM

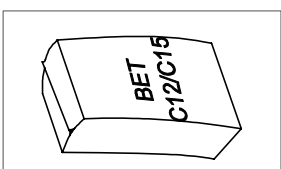

BET  
C-12/C15

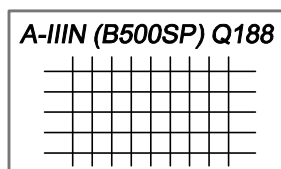

A-IIIN (B500SP) Q188

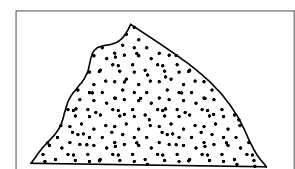

**(PL) Podłoże**

**(GB) Ground**

**(DE) Untergrund**

**(FR) Terrain**

**(IT) Suolo**

**(NL) Ondergrond**



**(PL)** *Struktura basenu wkopanego musi być zabezpieczona folią budowlaną.*

**(FR)** *La structure bois enterrée doit être protégée selon les instructions du manuel fourni.*

**(GB)** *Wooden structure if sunk in the ground must be protected in accordance with attached documentation.*

**(IT)** *La struttura della piscina scavata deve essere protetta con un cellofan da costruzione.*

**(DE)** *Holzkonstruktionen, die in den Boden eingelassen sind, müssen gemäß der beigefügten Dokumentation geschützt werden.*

**(NL)** *Houten structuur moet indien verzonken in de grond worden beschermd volgens de bijgevoegde en voorgeschreven documentatie.*

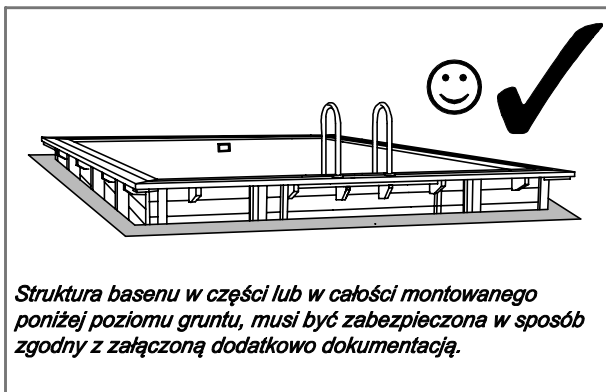
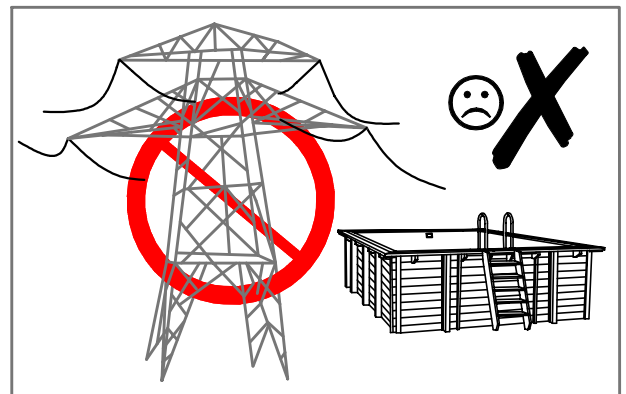
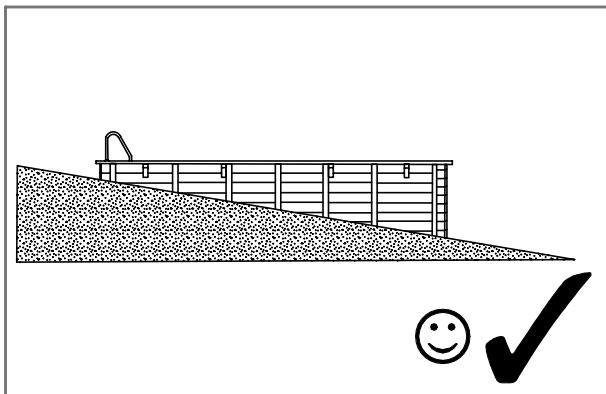
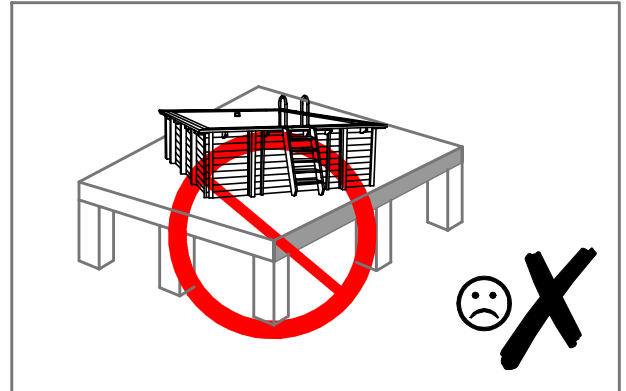
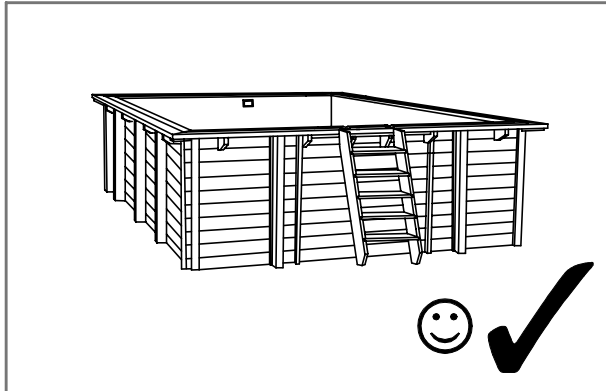

**(PL)** *Struktura basenu w części lub w całości montowanego poniżej poziomu gruntu, musi być zabezpieczona w sposób zgodny z załączoną dodatkowo dokumentacją.*

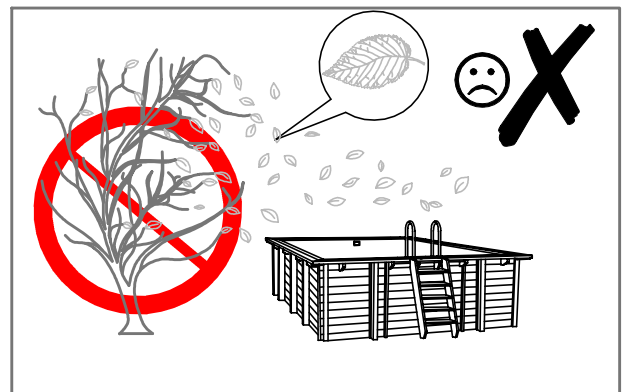

**(FR)** *Il est exigé que la structure de la piscine enterrée ou semi-enterrée soit convenablement protégée selon les indices dans le document supplémentaire ci-joint.*

**(GB)** *Wooden structure if partly or completely sunk in the ground should be protected in accordance to the enclosed additional documentation.*

**(IT)** *È esatto che la struttura della piscina sepolta o semi-sepolta sia protetta correttamente in allegato secondo gli indizi nel documento supplementare.*

**(DE)** *Holzkonstruktionen, die teilweise oder vollständig in den Boden eingelassen sind, sollten gemäß den beigefügten zusätzlichen Unterlagen geschützt werden.*

**(NL)** *Houten constructies die gedeeltelijk of volledig zijn verzonken in de grond moeten worden beschermd volgens de bijgevoegde aanvullende documentatie.*

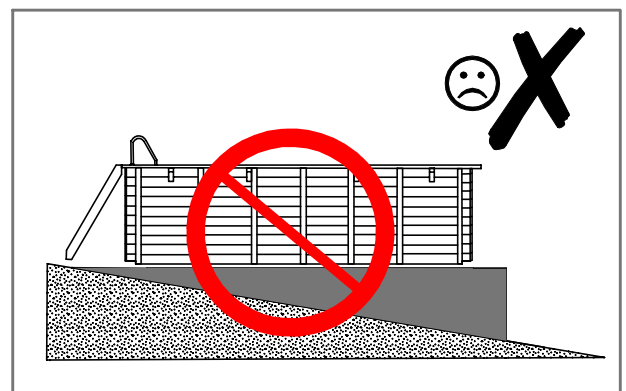

**(PL) Podłoże**

**(GB) Ground**

**(DE) Untergrund**

**(FR) Terrain**

**(IT) Suolo**

**(NL) Ondergrond**



**(PL)** Wymagane zabezpieczenie struktury przy montażu basenu poniżej poziomu gruntu.

**(FR)** Un système de protection de la structure est exigé dans le cas où la piscine est installée en dessous du niveau du sol.

**(GB)** Wooden structure protection required in case of in-ground installation.

**(IT)** La protezione della struttura nel caso della piscina totalmente o parzialmente sepolta.

**(DE)** Erforderliches Schutz für Struktur eines Holzpool, wenn es unter der Boden montieren.

**(NL)** Bescherming van de houten constructie is absoluut noodzakelijk bij ingebouwde zwembaden.

**1** FUNDAMENT BASENU / DALLE BETON / FOUNDATION / LASTRA CEMENTO / DAS FUNDAMENT / FUNDERING

**2** RURA DRENARSKA / TUYAU DE DRAINAGE / DRAINAGE PIPE / TUBO DI DRENAGGIO / DIE DRAINAGEROH / AFVOERPIJP

**3** PEÇHERZYKOWA FOLIA FUNDAMENTOWA / PROTECTION DE SOUBASSEMENT / FOINDATION BUBBLE WRAP / FONDALINE / DAS FUNDAMENT NOPPENFOLIE / BOUWFOLIE

**4** ŻWIR / GRAVIER / GRAVEL / GHIAIA / DER KIES / GRAVEL

**5** GEOWŁÓKNINA OGRODOWA / GEOTEXTILE / GEOTEXTILE / GEOTESSILI / GARTEN GEOTEXTILE / GEOTEXTEL

**6** GRUNT / TERRAIN / GROUND / TERRENO / DER BODEN / BODEM

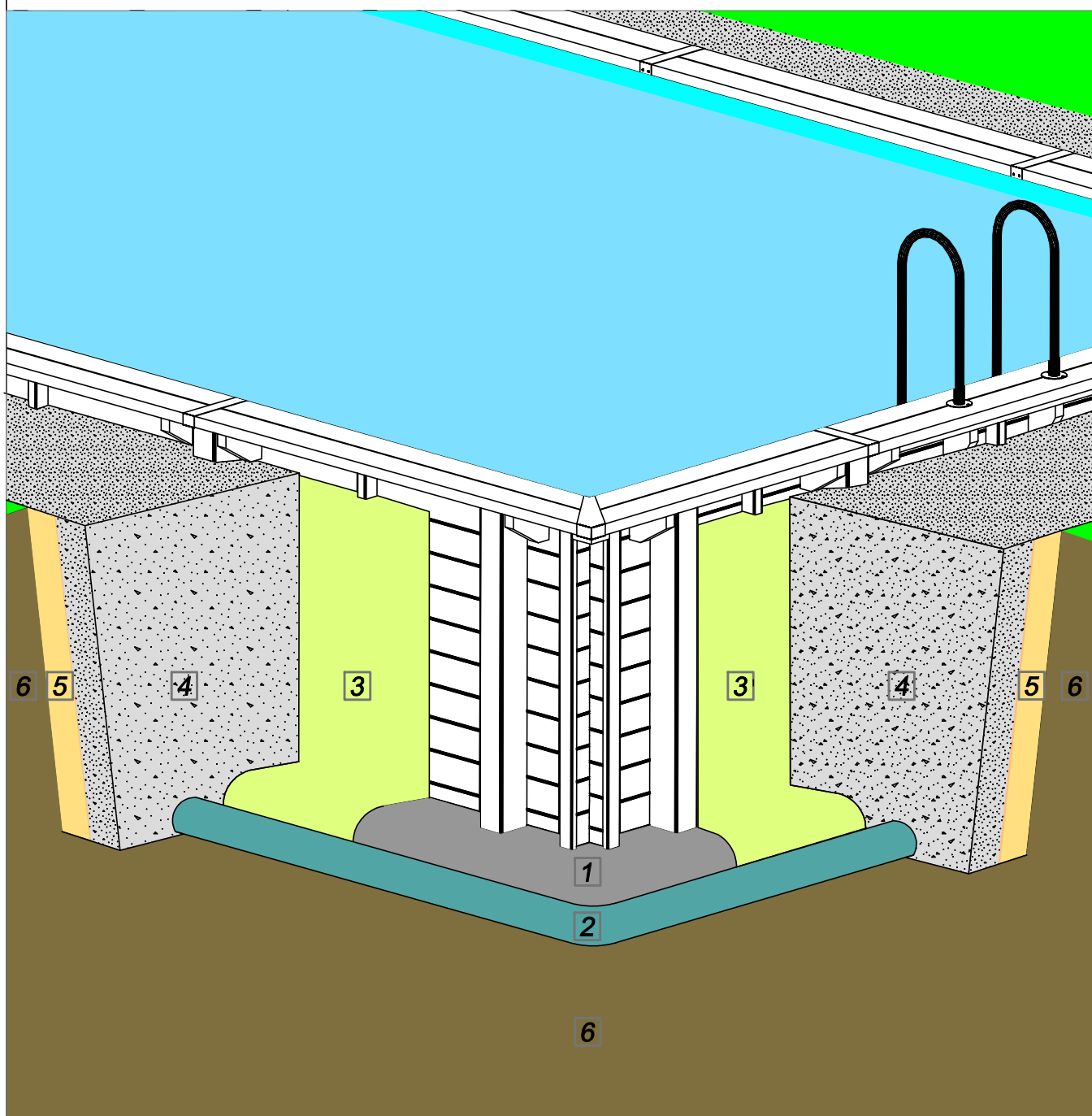

**PL** Podłoże

**GB** Ground

**DE** Untergrund

**FR** Terrain

**IT** Suolo

**NL** Ondergrond



**PL** Schemat przygotowania wykopu / podłoża pod zbrojoną wylewkę betonową.

**FR** Schema de préparation de l'excavation / lit de sable pour la dalle en béton armé.

**GB** Schema of preparation of excavation / ground for reinforced concrete screed.

**IT** Schema per la preparazione degli scavi / substrato ricoperto da cemento armato.

**DE** Schema der Vorbereitung von Aushub / Boden für Stahlbeton Estrich.

**NL** Opzet voor de voorbereiding van uitgraving/zand voor dekvloeren van gewapend beton.

[mm]

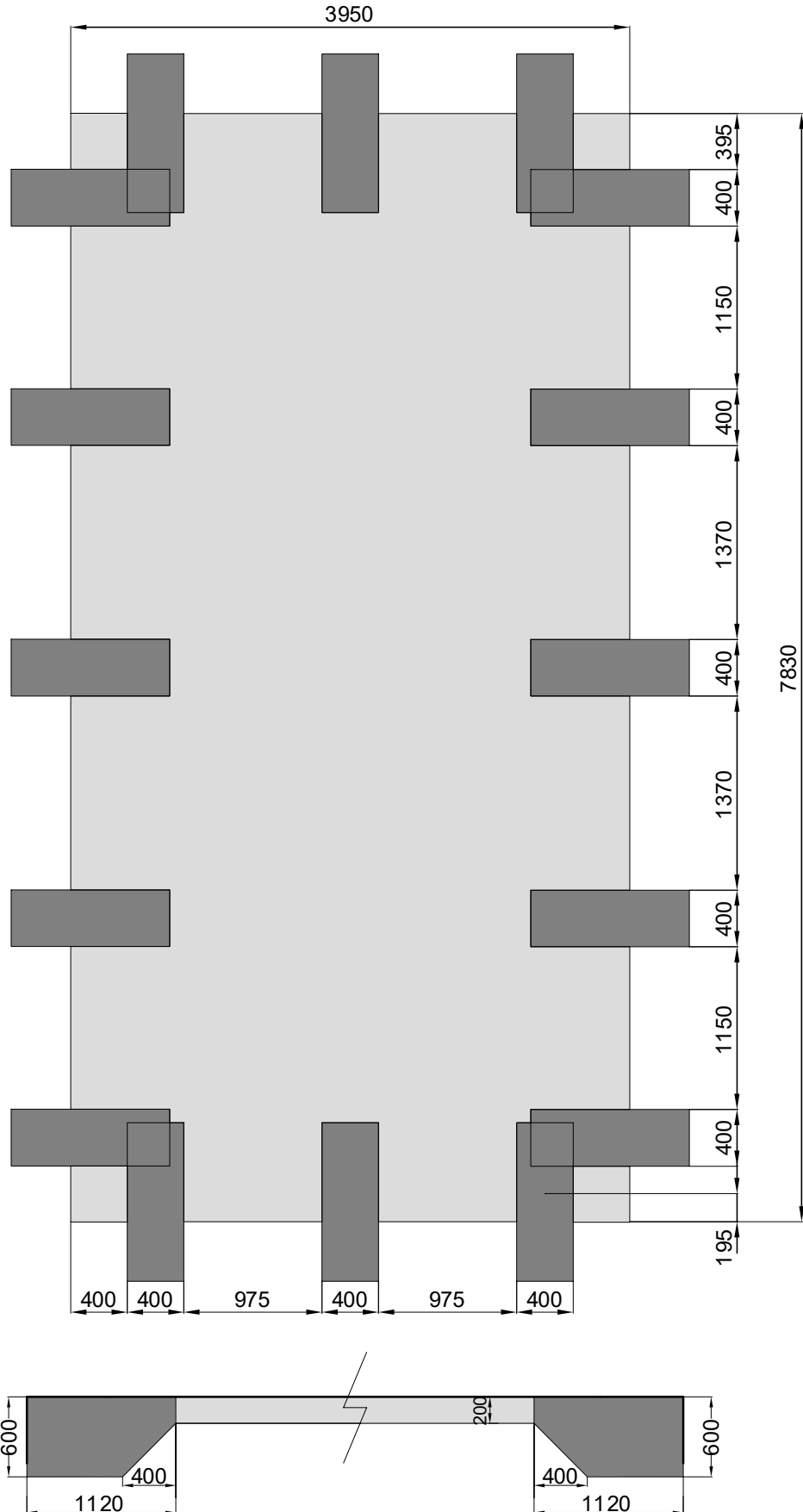

**(PL) Podłoże**

**(GB) Ground**

**(DE) Untergrund**

**(FR) Terrain**

**(IT) Suolo**

**(NL) Ondergrond**



- (PL)** Powierzchnia musi być twarda, płaska i wypoziomowana. Zastosuj piasek stabilizowany cementem.
- (FR)** La sous-couche doit être parfaitement ferme, plate et de niveau. Utilisez le sable stabilisé au ciment.
- (GB)** The surface must be firm, flat and leveled. Use cement-stabilized sand.
- (IT)** La superficie deve essere solida, piana e livellata. Utilizzare sabbia stabilizzata con cemento.
- (DE)** Der Untergrund muss fest, flach und eben sein. Verwenden Sie zementstabilisierten Sand.
- (NL)** De ondergrond moet stevig, vlak en waterpas zijn. Gebruik gestabiliseerd zandcement.

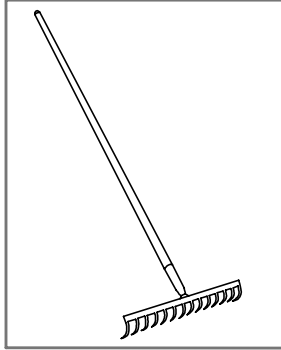
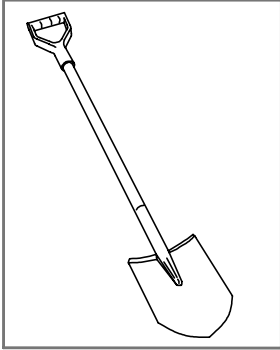

[mm]

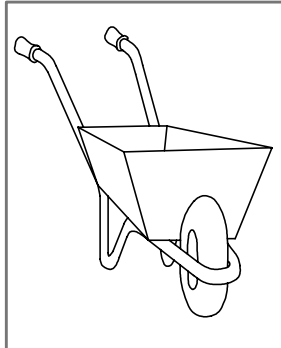
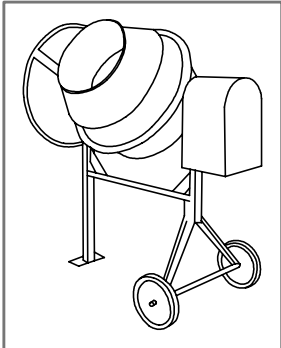
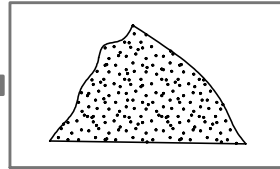
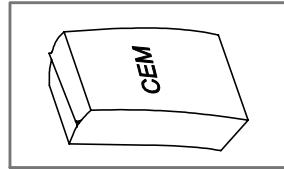
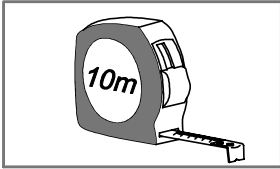
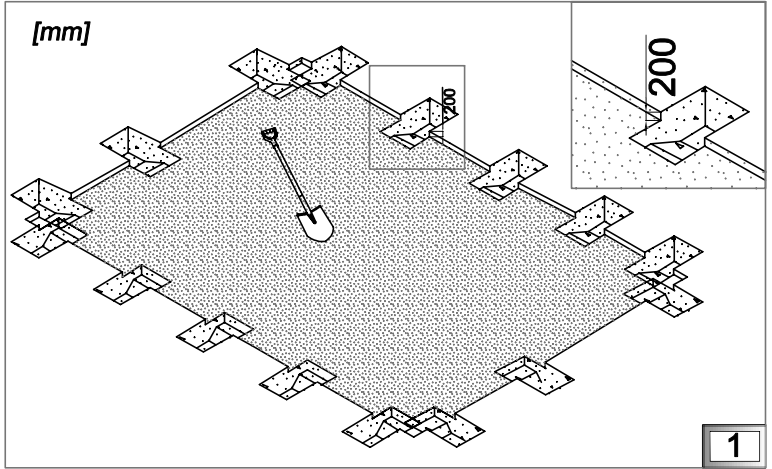

[mm]

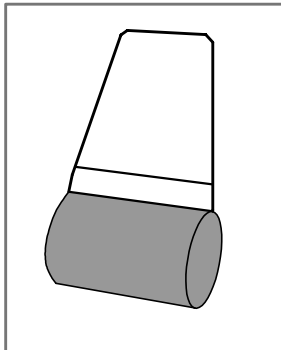
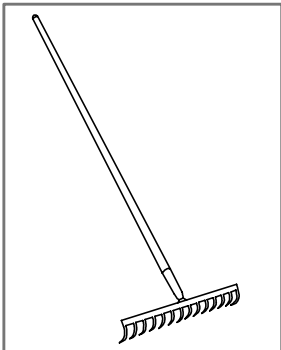
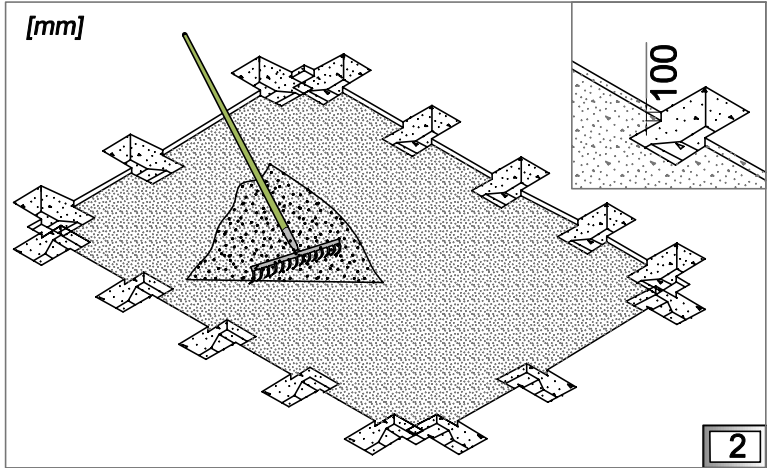

2T "T1"

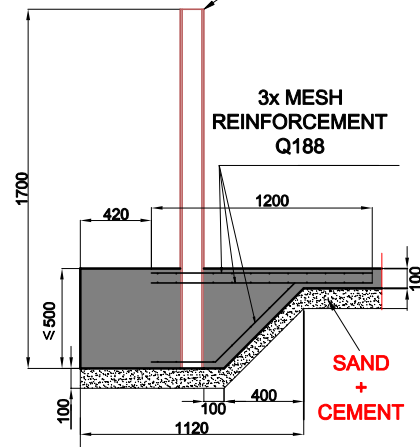
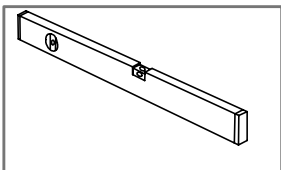

(PL) Podłoże

(GB) Ground

(DE) Untergrund

(FR) Terrain

(IT) Suolo

(NL) Ondergrond



(PL) Schemat rozmieszczenia słupków 2T (T1) oraz przygotowania zbrojenia pod wylewkę betonową.

(FR) Schema de positionnement des poteaux 2T (T1) et préparation de l'armature pour la dalle en béton.

(GB) Scheme of steel bearers 2T (T1) arrangement, preparing concrete base.

(IT) Schema per la spartizione dei pali 2T (T1) e per la preparazione dell'armatura sotto il calcestruzzo.

(DE) Schema der Stahlträger 2T (T1) Anordnung, Vorbereitung der Betonbasis.

(NL) Opzet voor stalen dragers 2T (T1) opstelling, voorbereiding van betonnen basis.

[mm]

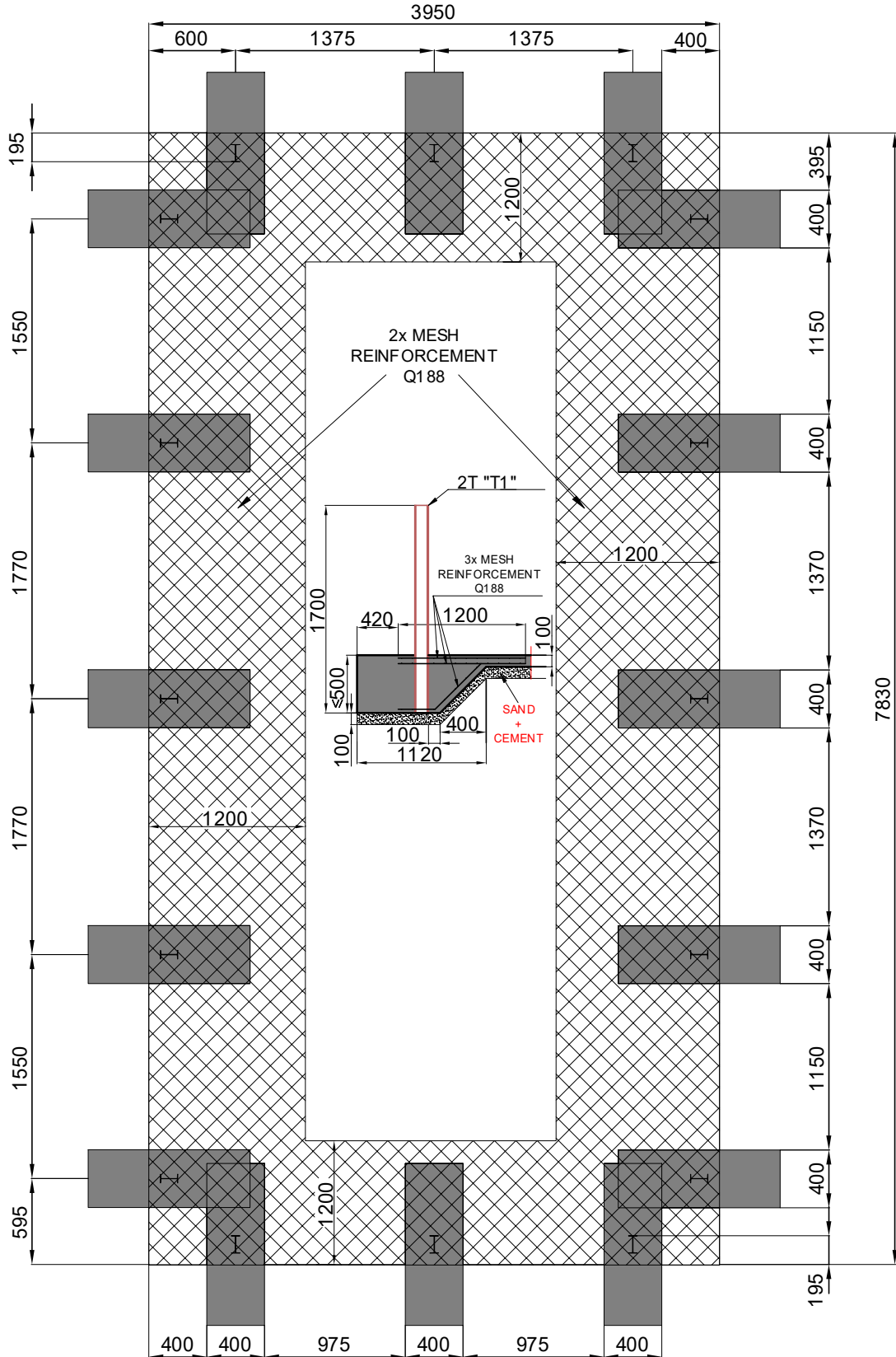

**(PL) Podłoże**

**(GB) Ground**

**(DE) Untergrund**

**(FR) Terrain**

**(IT) Suolo**

**(NL) Ondergrond**



**(PL)** Powierzchnia musi być twarda, płaska i wypoziomowana. Pamiętaj o wykonaniu zbrojenia wylewki betonowej.

**(FR)** La sous-couche doit être parfaitement ferme, plate et de niveau. Préparez l'armature de la dalle en béton.

**(GB)** The surface must be firm, flat and leveled. Remember about reinforcement of concrete screed.

**(IT)** La superficie deve essere solida, piana e livellata. Ricordati di eseguire l'armatura per il calcestruzzo.

**(DE)** Der Untergrund muss fest, flach und eben sein. Denken Sie an die Verstärkung des Betonstrichs.

**(NL)** De ondergrond moet stevig, vlak en waterpas zijn. Denk aan de versterking van de dekvloer van beton.

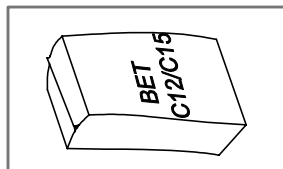

A-IIIIN (B500SP) Q188

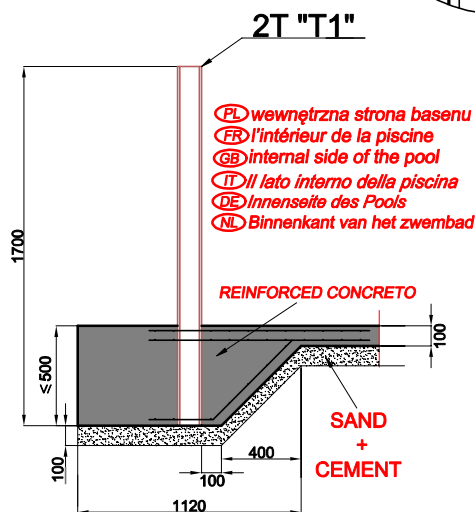
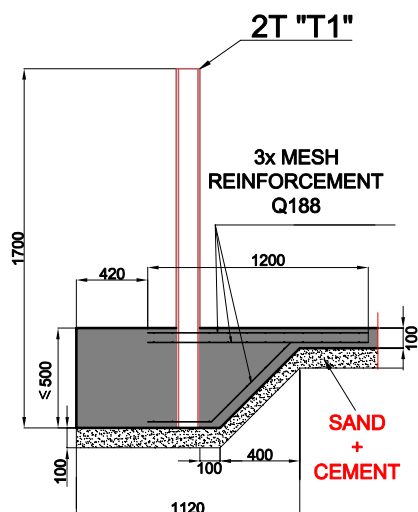
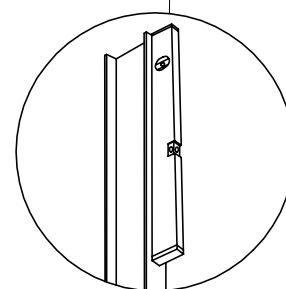
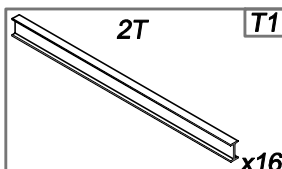
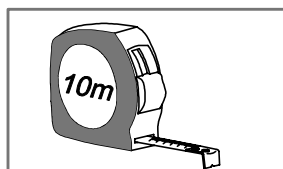
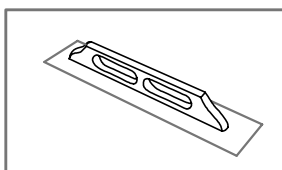
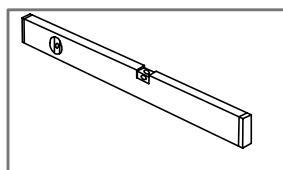
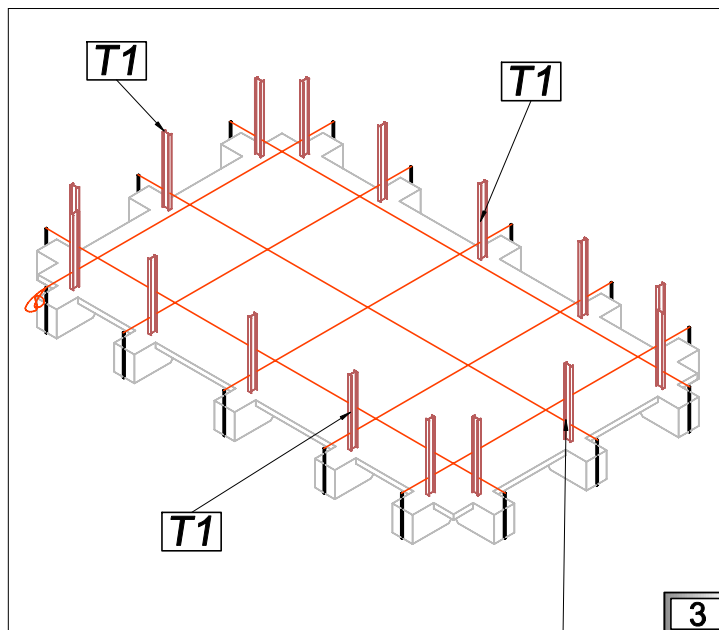
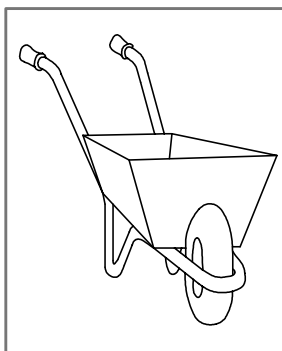
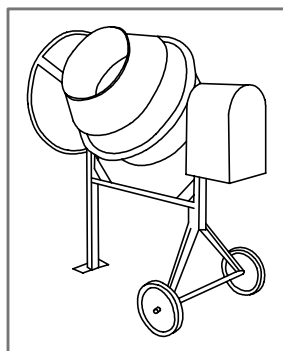
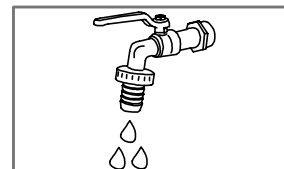
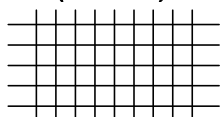

**(PL)** wewnętrzna strona basenu  
**(FR)** l'intérieur de la piscine  
**(GB)** internal side of the pool  
**(IT)** Il lato interno della piscina  
**(DE)** Innenseite des Pools  
**(NL)** Binnenkant van het zwembad



**(PL) Podłoże**

**(GB) Ground**

**(DE) Untergrund**

**(FR) Terrain**

**(IT) Suolo**

**(NL) Ondergrond**



**(PL)** Schemat rozmieszczenia słupków 2T (T1) oraz przygotowania zbrojenia pod wylewkę betonową.

**(FR)** Schema de positionnement des poteaux 2T (T1) et préparation de l'armature pour la dalle en béton.

**(GB)** Scheme of steel bearers 2T (T1) arrangement, preparing concrete base.

**(IT)** Schema per la spartizione dei pali 2T (T1) e per la preparazione dell'armatura sotto il calcestruzzo.

**(DE)** Schema der Stahlträger 2T (T1) Anordnung, Vorbereitung der Betonbasis.

**(NL)** Opzet voor stalen dragers 2T (T1) opstelling, voorbereiding van betonnen basis.

**[mm]**

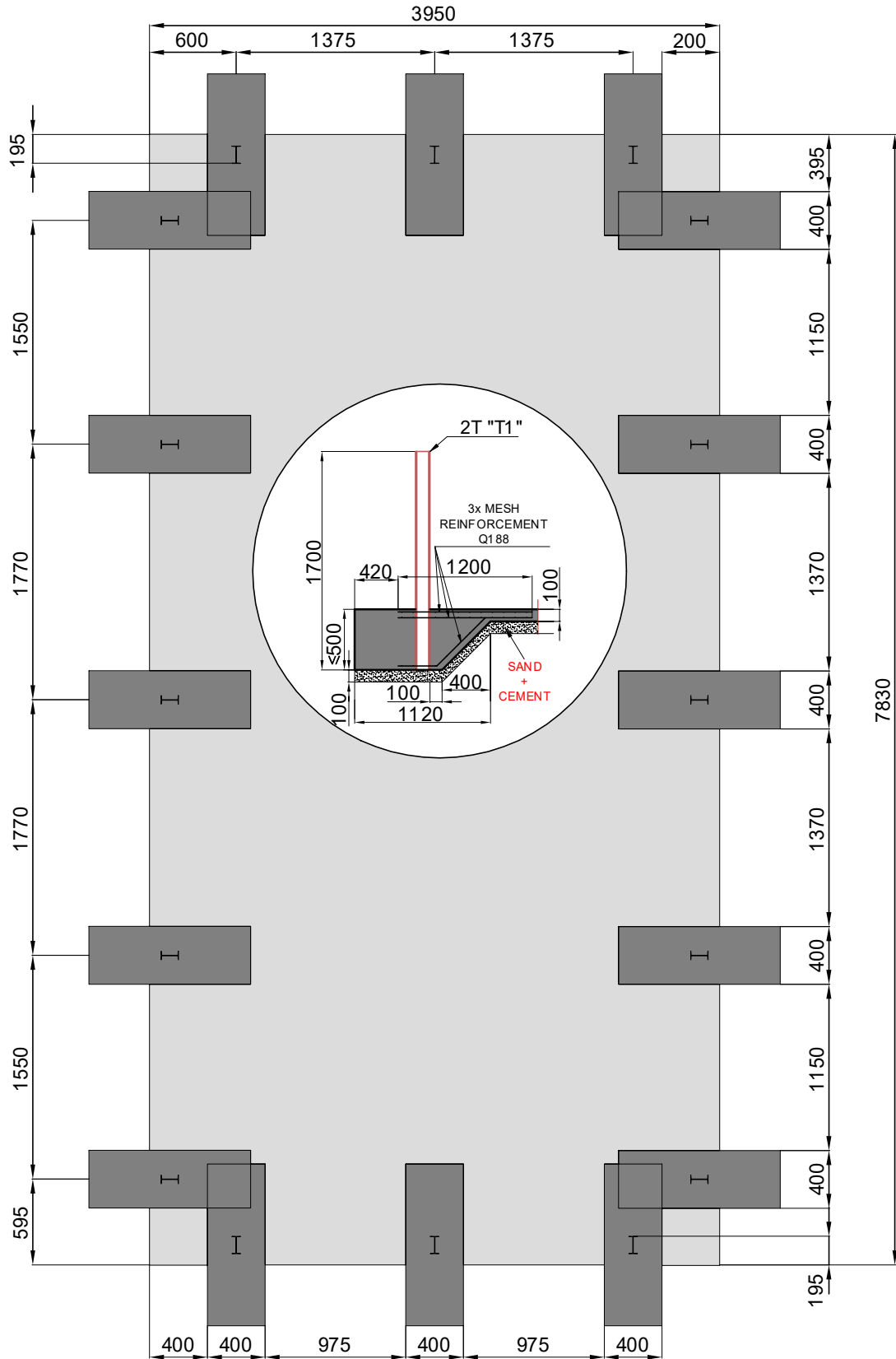

**(PL)** Struktura drewniana

**(GB)** Wooden structure

**(DE)** Holzstruktur

**(FR)** La structure bois

**(IT)** Struttura in legno

**(NL)** Houten structuur



**(PL)** Schemat rozmieszczenia warstw struktury. Ułożenie warstwy I.

**(FR)** Schéma de disposition des couches de la structure. Pose de la couche I.

**(GB)** Arrangement of structure's layers. Putting layer I.

**(IT)** Schematica degli strati della struttura. Posare lo strato I.

**(DE)** Anordnung der Schichten der Struktur. Auflegen der I-Schichte.

**(NL)** Opbouw van de structuurlagen.

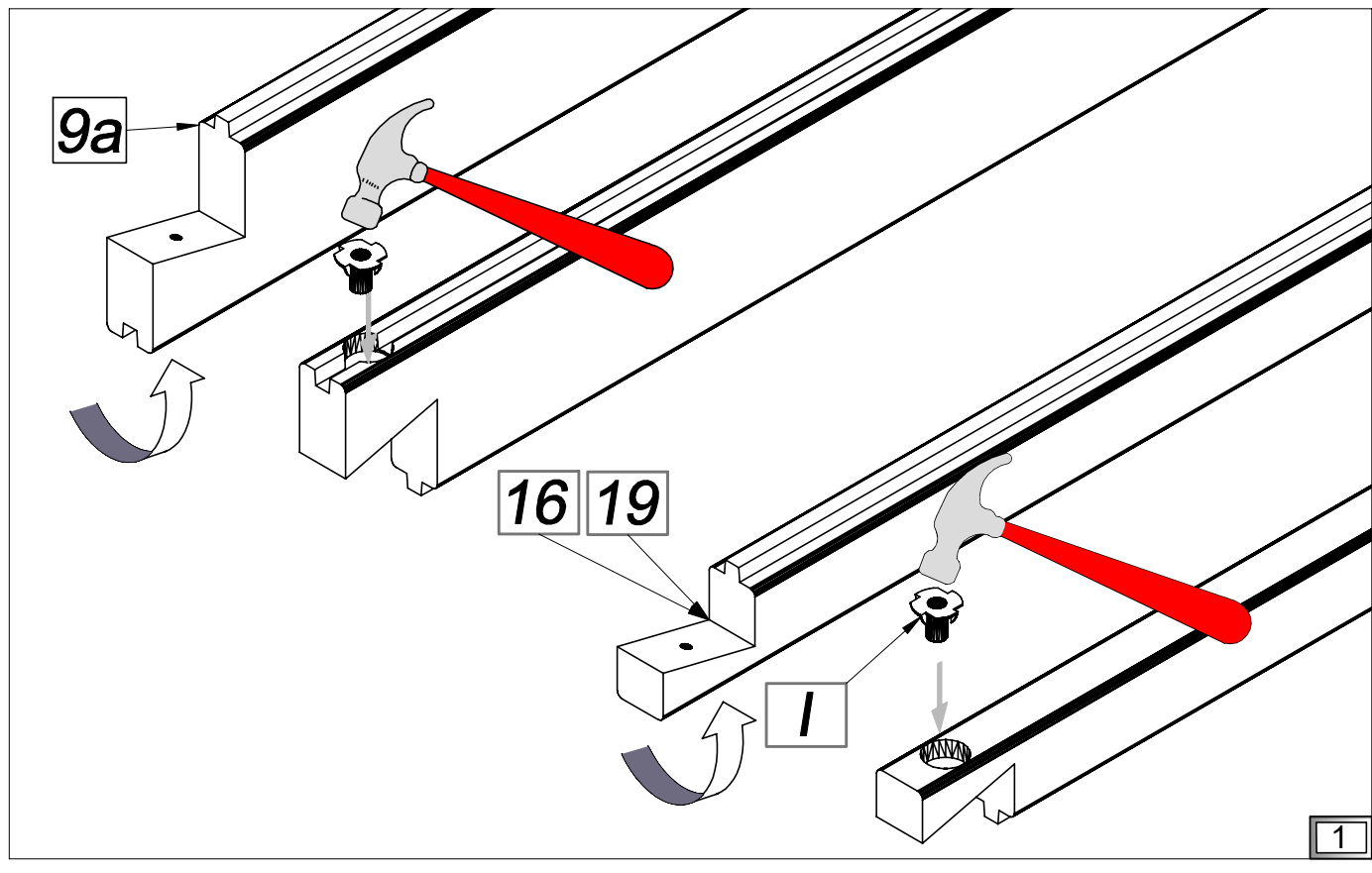
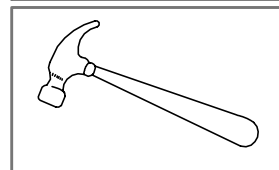
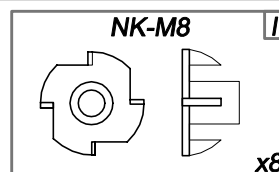
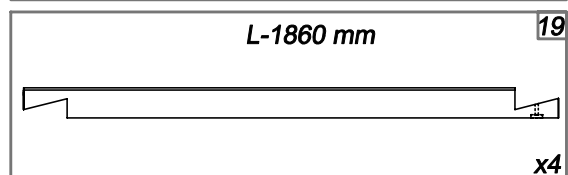
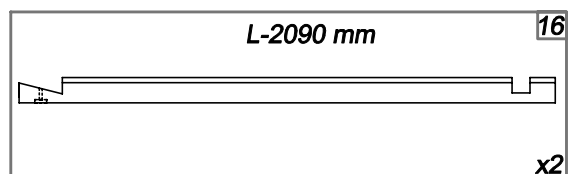
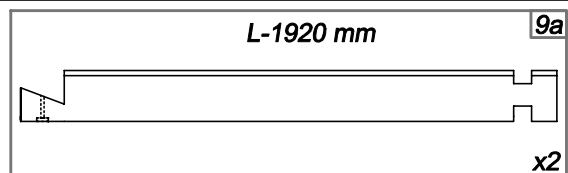
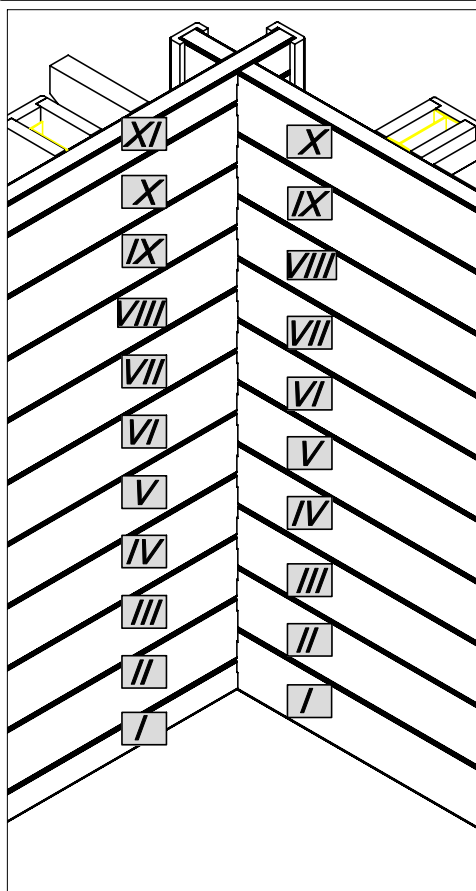

**PL** *Struktura drewniana*

**GB** *Wooden structure*

**DE** *Holzstruktur*

**FR** *La structure bois*

**IT** *Struttura in legno*

**NL** *Houten structuur*



**PL** Schemat rozmieszczenia warstw struktury. Ułożenie warstwy I.

**FR** Schéma de disposition des couches de la structure. Pose de la couche I.

**GB** Arrangement of structure's layers. Putting layer I.

**IT** Schematica degli strati della struttura. Posare lo strato I.

**DE** Anordnung der Schichten der Struktur. Auflegen der I-Schichte.

**NL** Opbouw van de structuurlagen.

L-1920 mm

5



x2

L-2090 mm

13

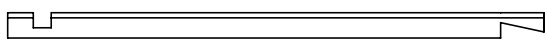

x2

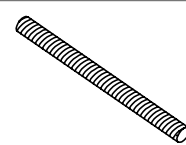

L

x8

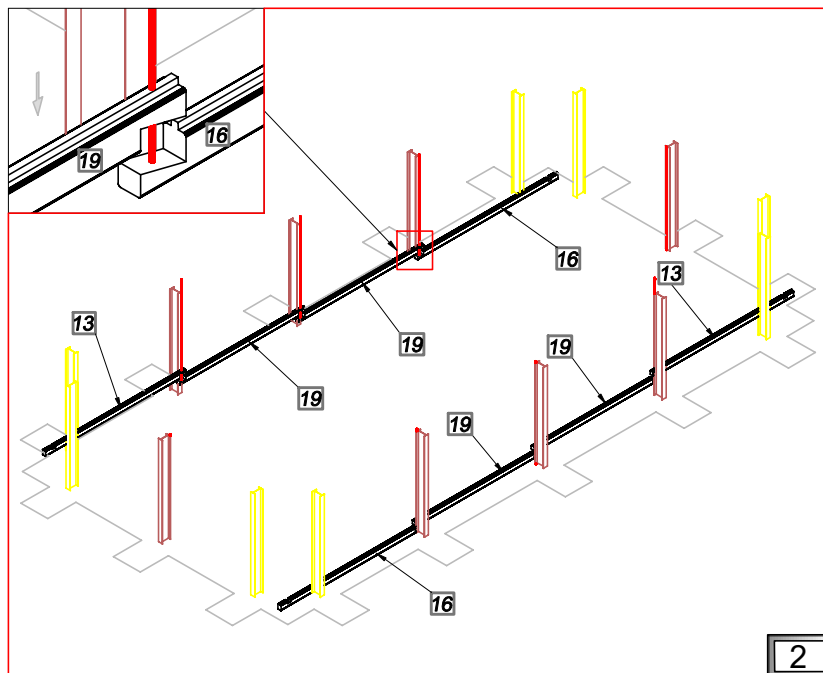
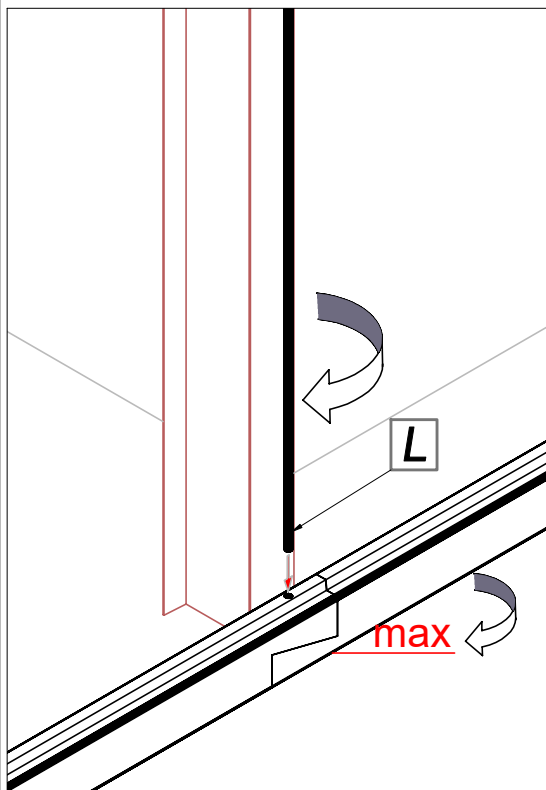

2

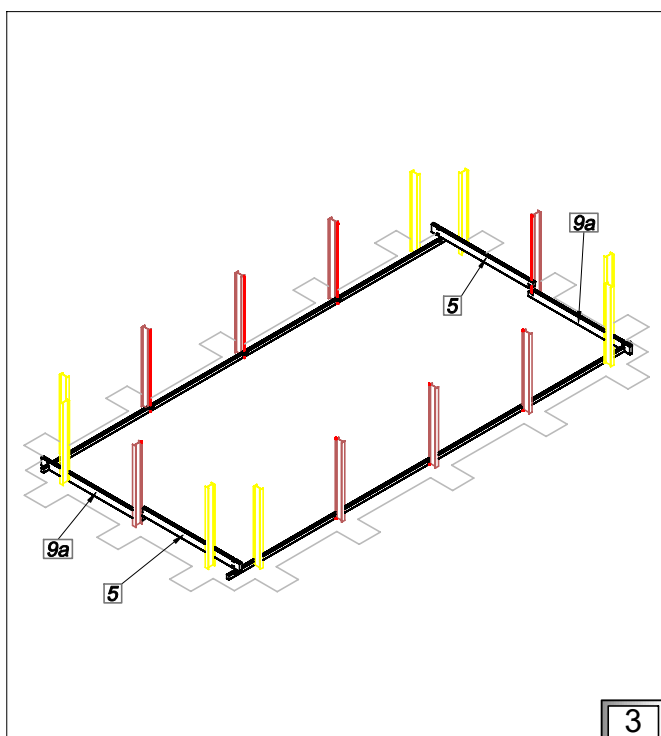

3

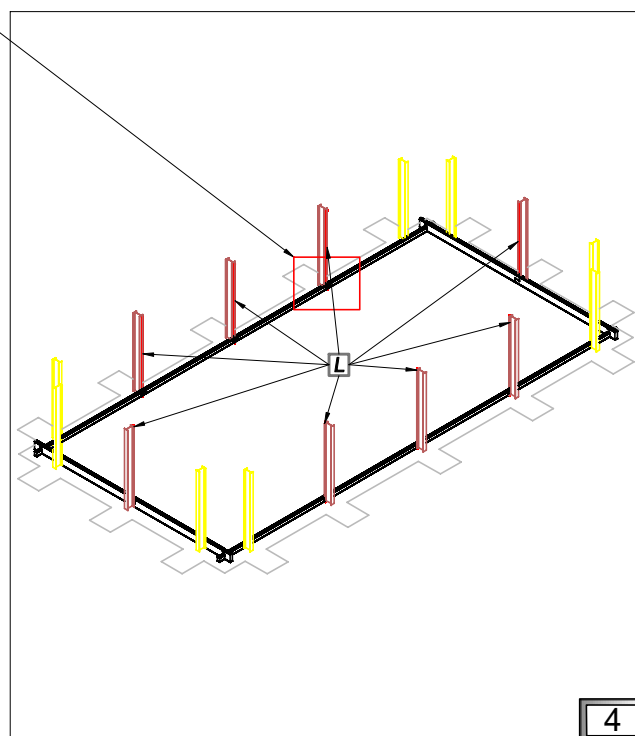

4

**(PL) Struktura drewniana**

**(GB) Wooden structure**

**(DE) Holzstruktur**

**(FR) La structure bois**

**(IT) Struttura in legno**

**(NL) Houten structuur**



**(PL)** Po ułożeniu każdej z warstw sprawdź przekątne według rysunku.

**(FR)** Vérifiez après la pose de chaque couche que les diagonales soient bien conformes au dessin technique.

**(GB)** After putting each layer check diagonals according to the drawing.

**(IT)** Dopo la posa di ogni strato bisogna controllare diagonali, secondo il disegno

**(DE)** Nachdem Sie jede Schicht angeordnet haben, überprüfen Sie die Diagonalen gemäß der Zeichnung.

**(NL)** Controleer na het aanbrengen van elke laag de diagonalen volgens de tekening.

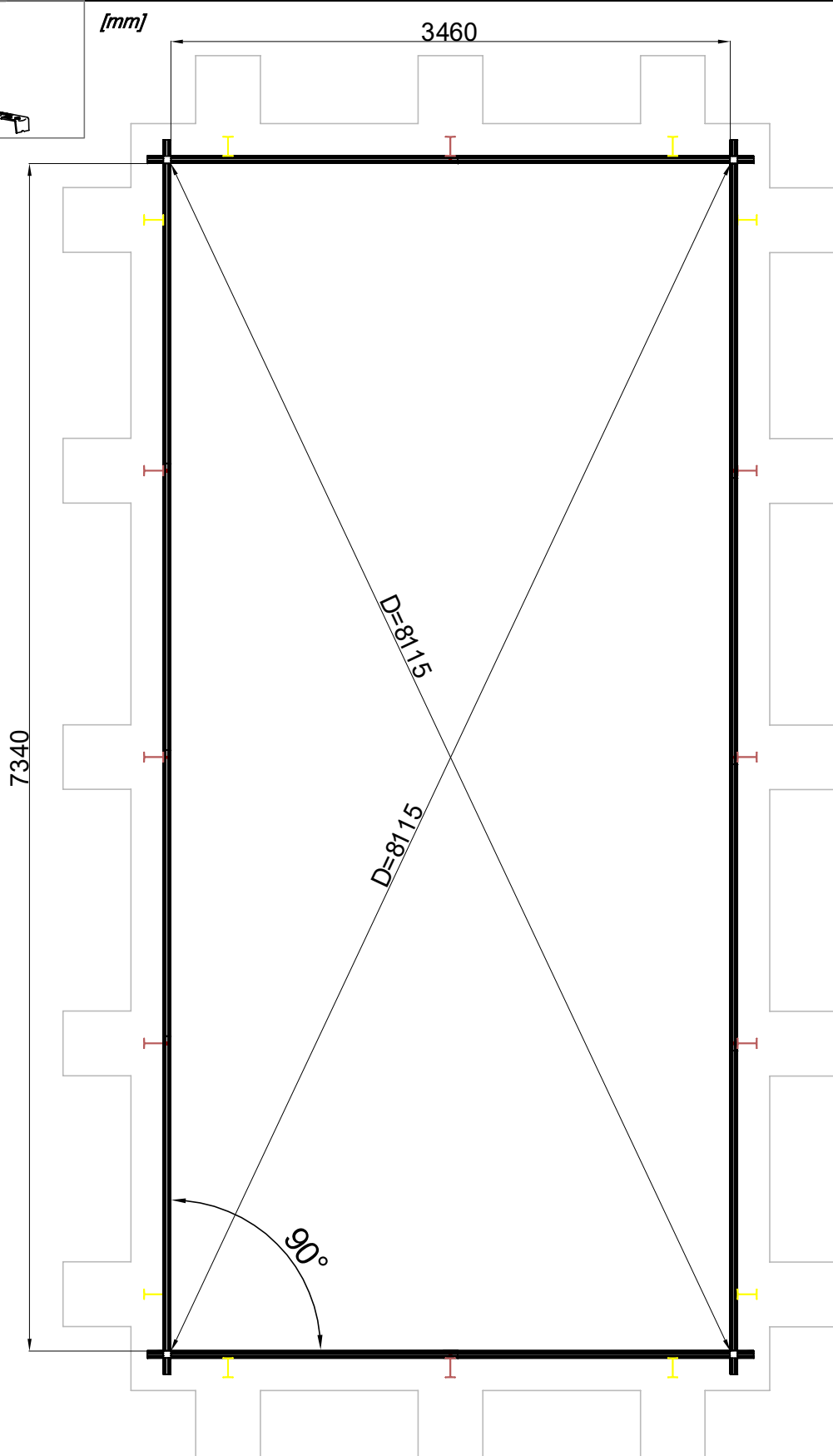
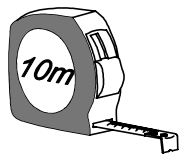

**PL** Struktura drewniana

**GB** Wooden structure

**DE** Holzstruktur

**FR** La structure bois

**IT** Struttura in legno

**NL** Houten structuur



**PL** Ułożenie kolejnych warstw. Sprawdzaj przekątną po każdej ułożonej warstwie.

**FR** L'assemblage des couches suivantes. Vérifiez la conformité des diagonales après la pose de chaque couche.

**GB** Arrangement of layers. Check diagonals after having arranged each layer.

**IT** La messa degli strati successivi. Trova la diagonale dopo ogni strato.

**DE** Anordnung der Schichten. Überprüfen Sie die Diagonalen nachdem Sie jede Schichte angeordnet haben.

**NL** Opbouw van de lagen. Controleer de diagonalen na het aanbrengen van elke laag.

L-2090 mm

11

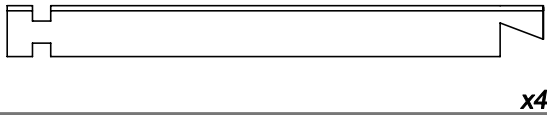

x4

L-2090 mm

14

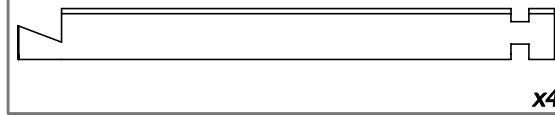

x4

L-1920 mm

5

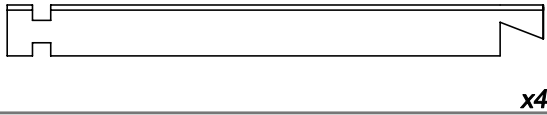

x4

L-1920 mm

9

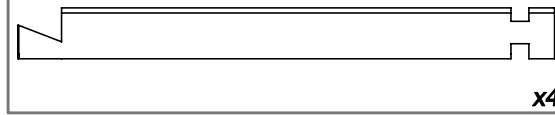

x4

L-1860 mm

17

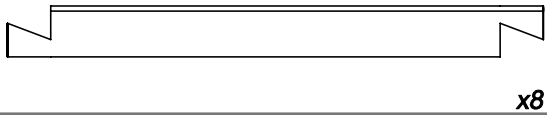

x8

39

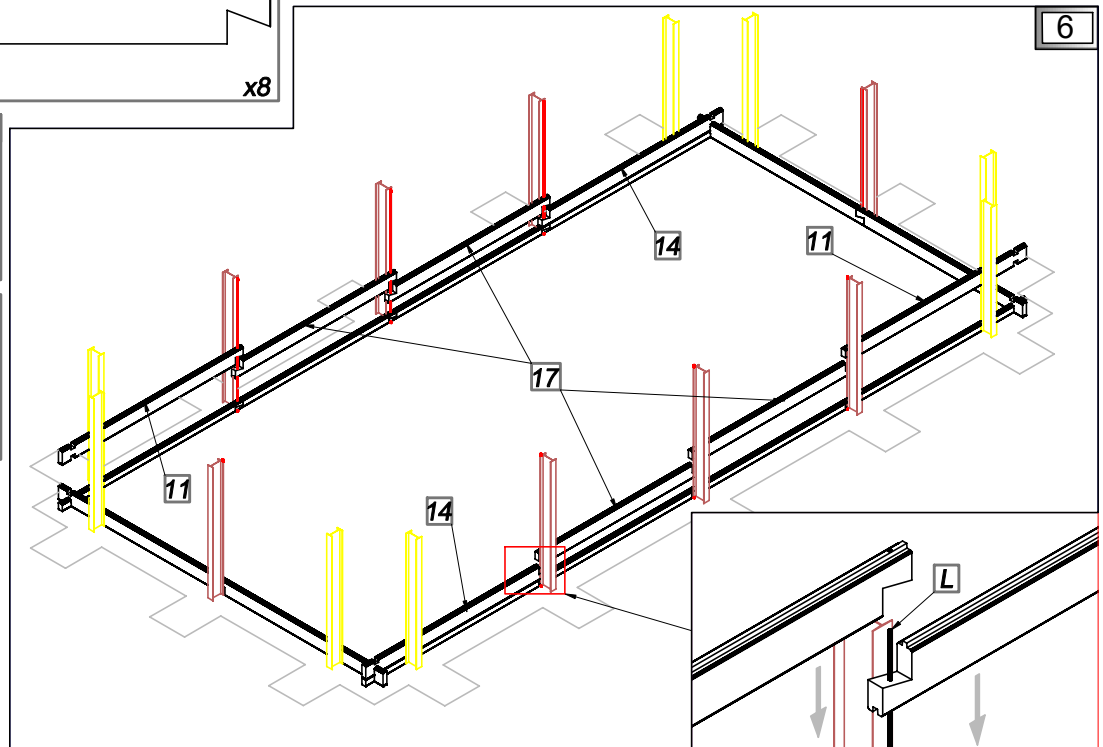
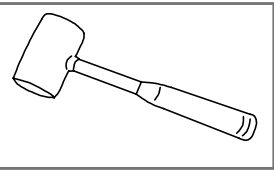
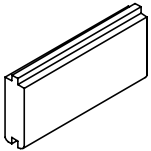

6

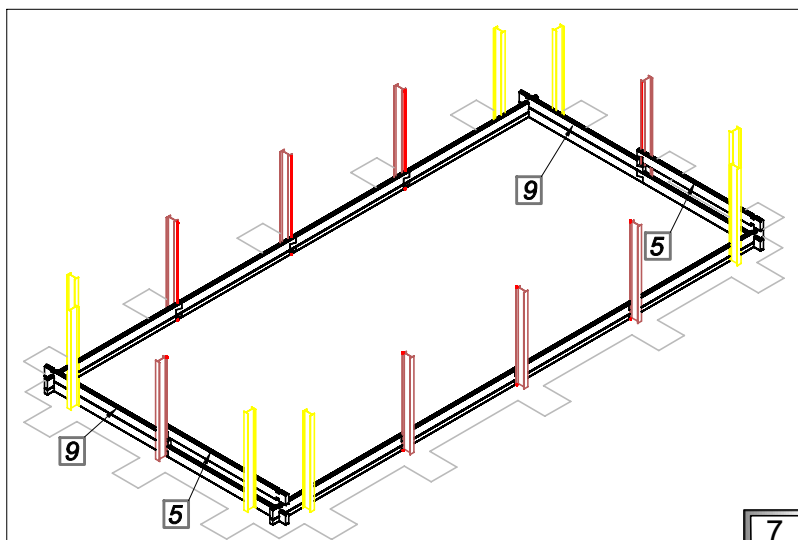

7

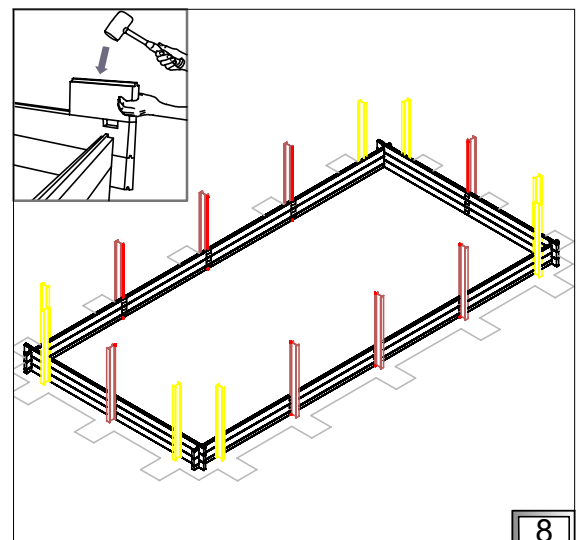

8

II-III

**(PL)** Struktura drewniana

**(GB)** Wooden structure

**(DE)** Holzstruktur

**(FR)** La structure bois

**(IT)** Struttura in legno

**(NL)** Houten structuur



**(PL)** Ułożenie kolejnych warstw. Sprawdzaj przekątną po każdej ułożonej warstwie.

**(FR)** L'assemblage des couches suivantes. Vérifiez la conformité des diagonales après la pose de chaque couche.

**(GB)** Arrangement of layers. Check diagonals after having arranged each layer.

**(IT)** La messa degli strati successivi. Trova la diagonale dopo ogni strato.

**(DE)** Anordnung der Schichten. Überprüfen Sie die Diagonalen nachdem Sie jede Schicht angeordnet haben.

**(NL)** Opbouw van de lagen. Controleer de diagonalen na het aanbrengen van elke laag.

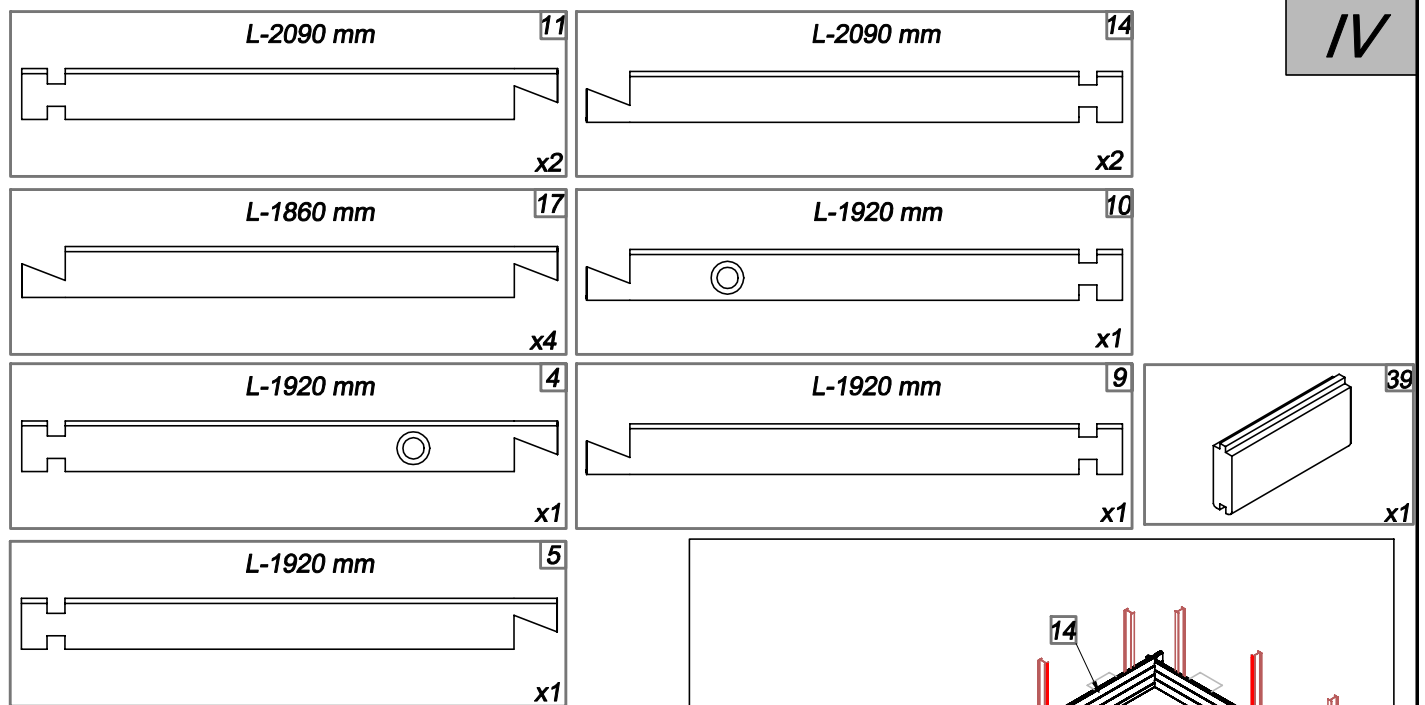

**(NL)** Installeer balk nummer 4, 10 alleen op laag 4 in gebieden waar de temperatuur niet onder nul komt, is dit wel het geval plaats dan balk nummer 4, 10 drie lagen hoger (risico op bevriezing)

**(DE)** Installieren Sie die Nr. 4, 10 auf der Schicht 4, wo fällt die Temperatur unten 0 ° C. Anderenfalls Teil Nr. 4, 10 installieren Schicht oben. (Risiko ganz gefroren.)

**(GB)** Install the beam no 4, 10 on the 4th layer. If pool installed in area where temperatures fall below 0°C, install the beam no 4, 10 on higher layer.

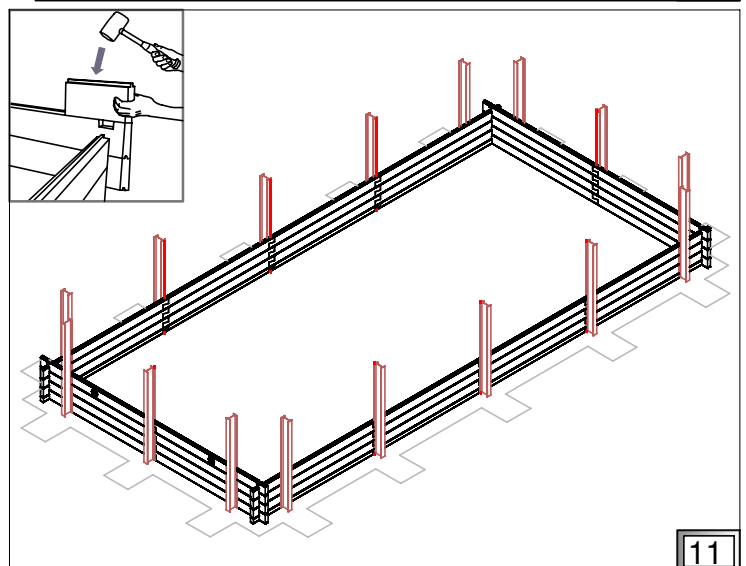
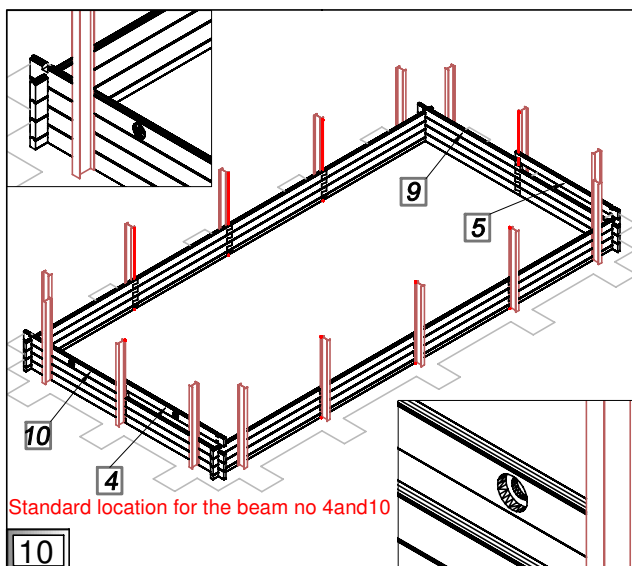
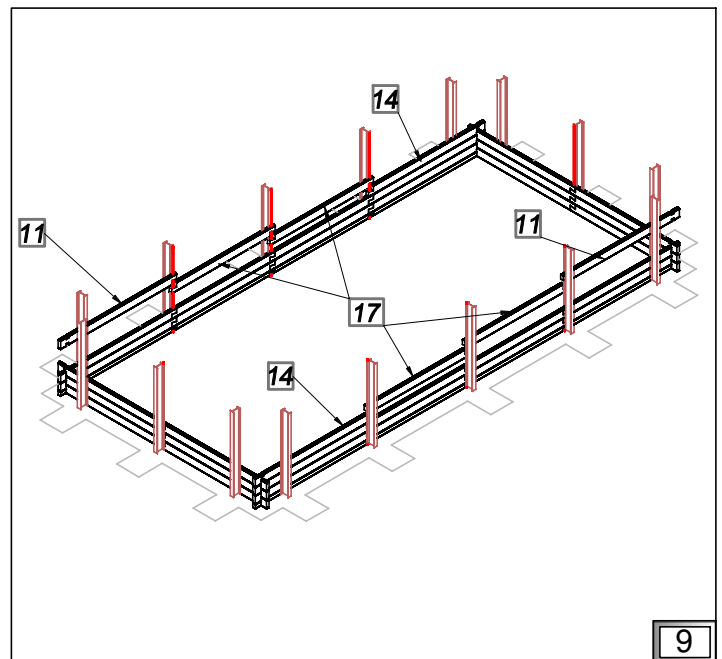

**PL** *Struktura drewniana*

**GB** *Wooden structure*

**DE** *Holzstruktur*

**FR** *La structure bois*

**IT** *Struttura in legno*

**NL** *Houten structuur*



**PL** Ułożenie kolejnych warstw. Sprawdzaj przekątną po każdej ułożonej warstwie.

**FR** L'assemblage des couches suivantes. Vérifiez la conformité des diagonales après la pose de chaque couche.

**GB** Arrangement of layers. Check diagonals after having arranged each layer.

**IT** La messa degli strati successivi. Trova la diagonale dopo ogni strato.

**DE** Anordnung der Schichten. Überprüfen Sie die Diagonalen nachdem Sie jede Schichte angeordnet haben.

**NL** Opbouw van de lagen. Controleer de diagonalen na het aanbrengen van elke laag.

V-VIII

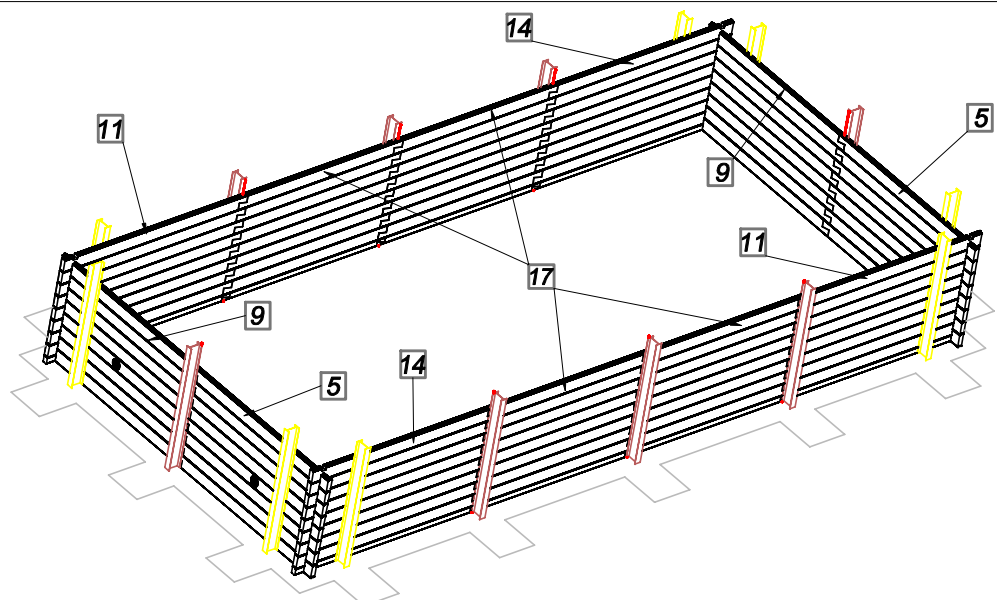
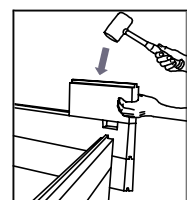
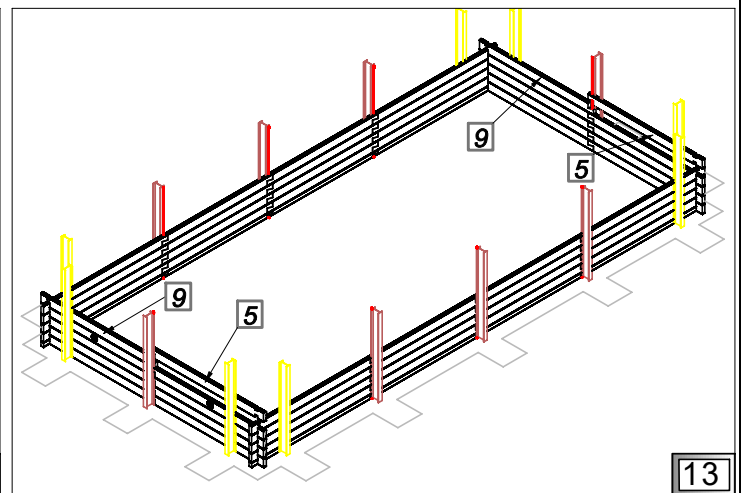
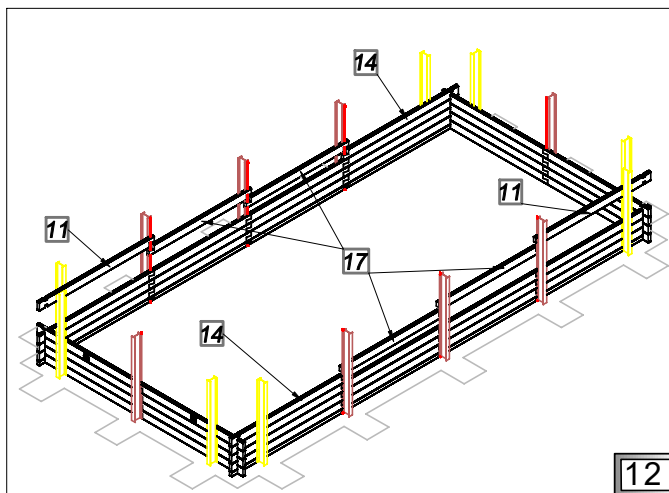
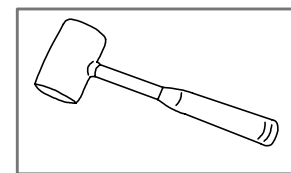
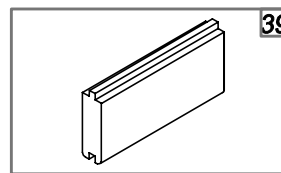
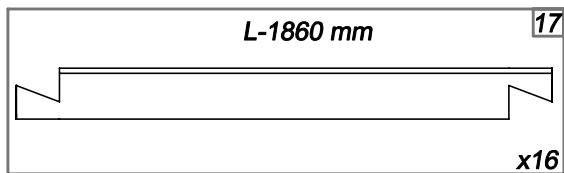
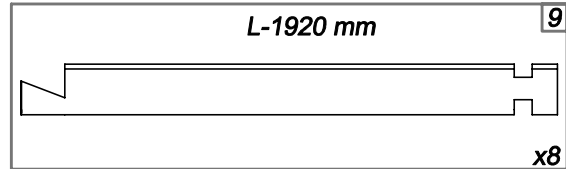
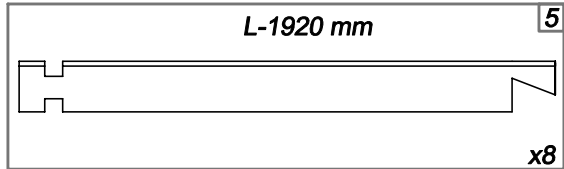
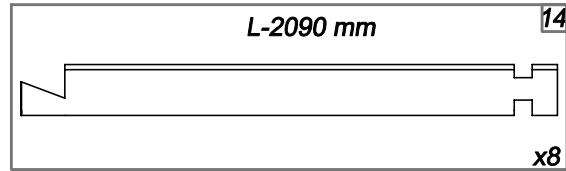
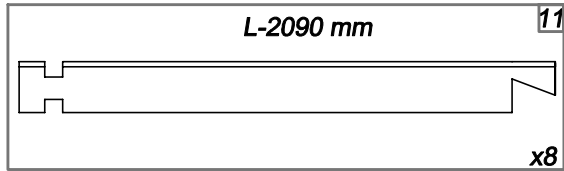

14

**PL** Struktura drewniana

**GB** Wooden structure

**DE** Holzstruktur

**FR** La structure bois

**IT** Struttura in legno

**NL** Houten structuur



**PL** Ułożenie kolejnych warstw. Sprawdzaj przekątną po każdej ułożonej warstwie.

**FR** L'assemblage des couches suivantes. Vérifiez la conformité des diagonales après la pose de chaque couche.

**GB** Arrangement of layers. Check diagonals after having arranged each layer.

**IT** La messa degli strati successivi. Trova la diagonale dopo ogni strato.

**DE** Anordnung der Schichten. Überprüfen Sie die Diagonalen nachdem Sie jede Schichte angeordnet haben.

**NL** Opbouw van de lagen. Controleer de diagonalen na het aanbrengen van elke laag.

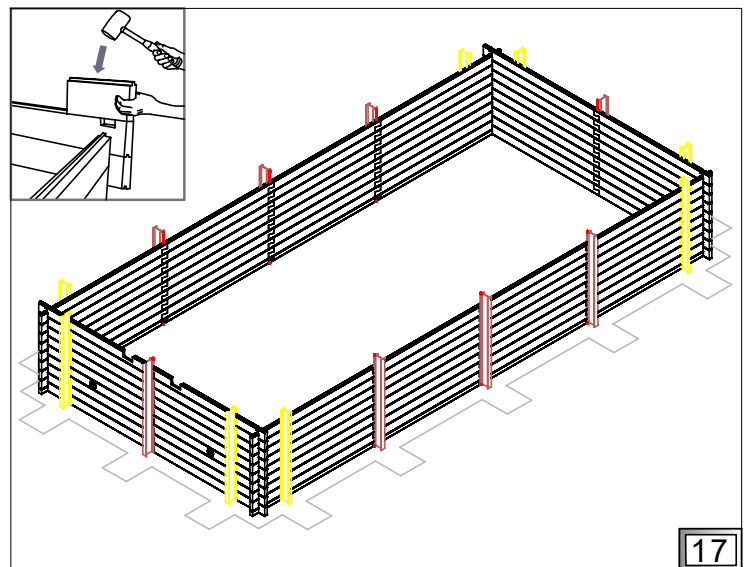
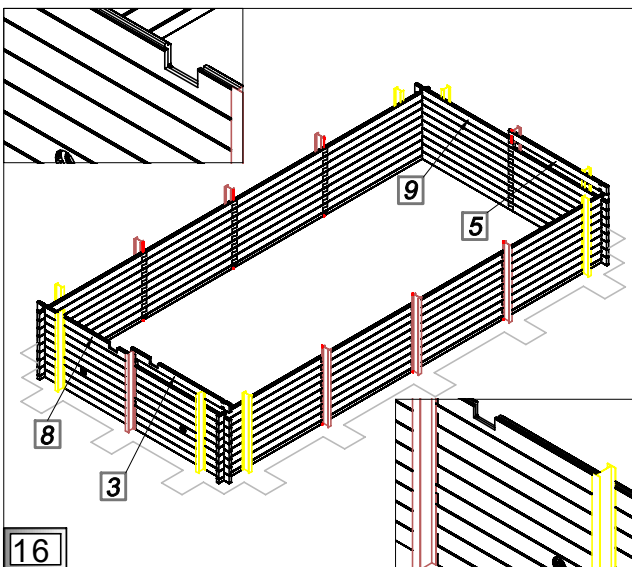
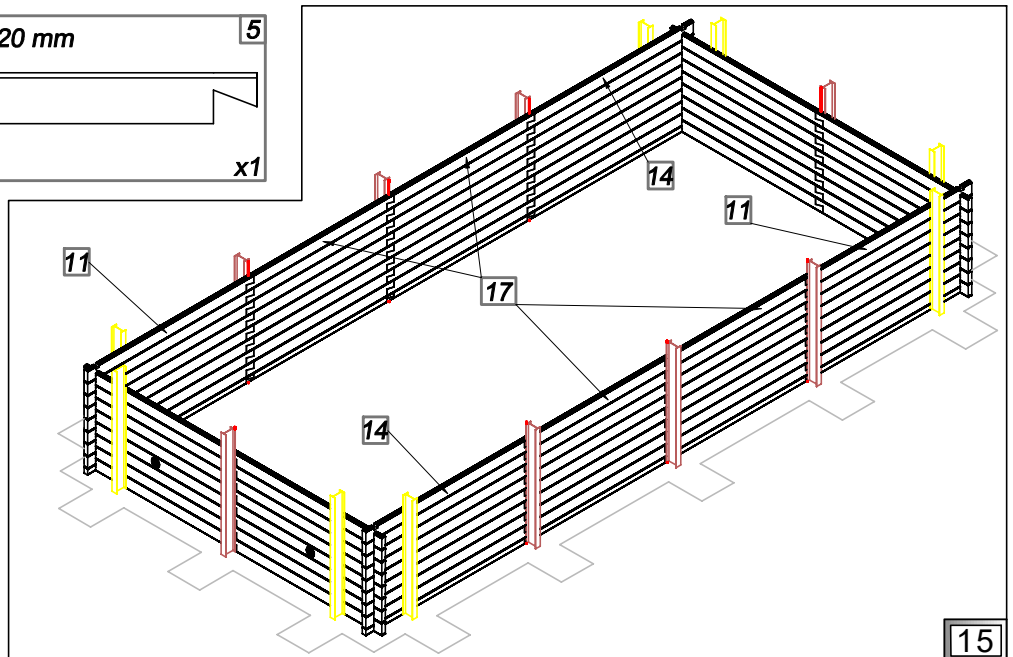
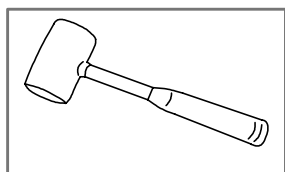
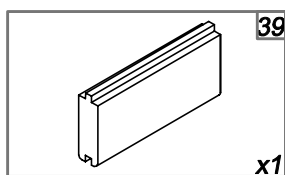
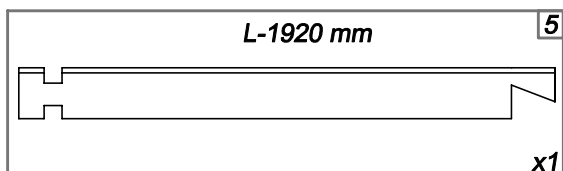
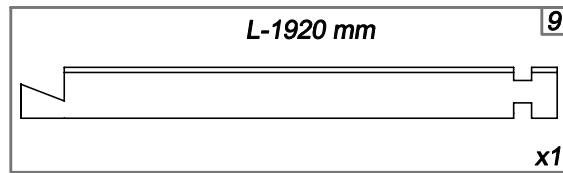
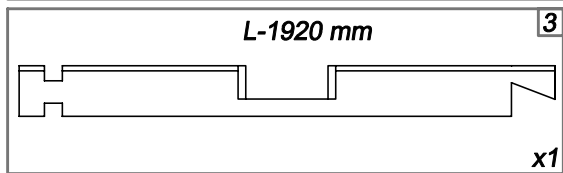
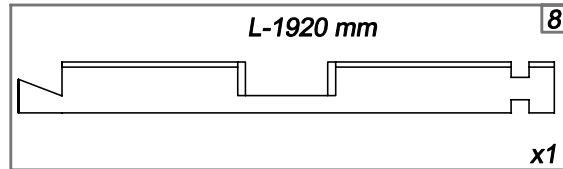
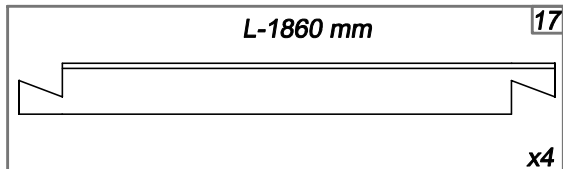
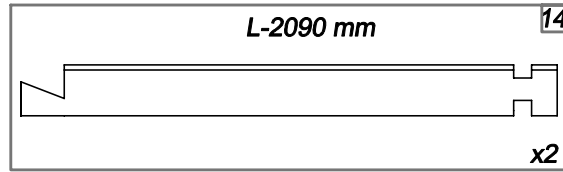
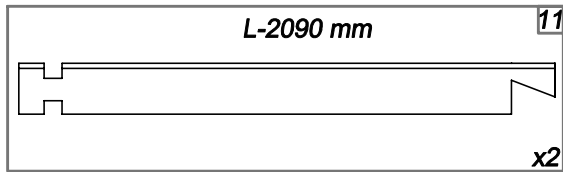

**IX**

16

17



**PL** Skimmer

**GB** Skimmer

**DE** Skimmer

**FR** Skimmer

**IT** Skimmer

**NL** Skimmer



**PL** Zmontuj skimmer wg rysunków. Następnie zamontuj go w strukturze.

**FR** Montez le skimmer suivant les dessins. Ensuite fixez-le à la structure.

**GB** Install a skimmer according to the drawings. Next mount it to the structure.

**IT** Montare lo skimmer secondo i disegni. Poi installarlo nella struttura.

**DE** Installieren Sie den Skimmer entsprechend der Zeichnungen. Als nächstes montieren Sie ihn an die Struktur.

**NL** Installeer de skimmer volgens de tekeningen. Monteer het vervolgens op de structuur.

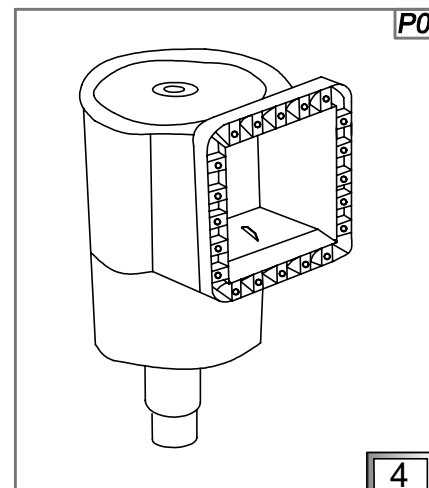
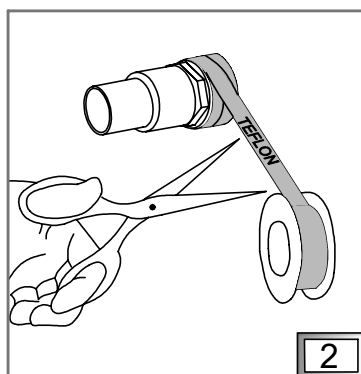
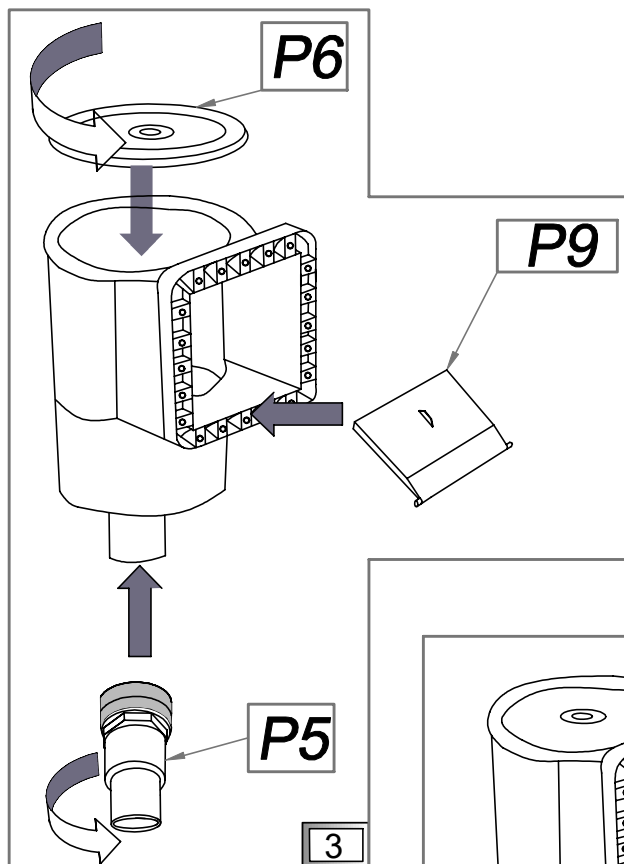
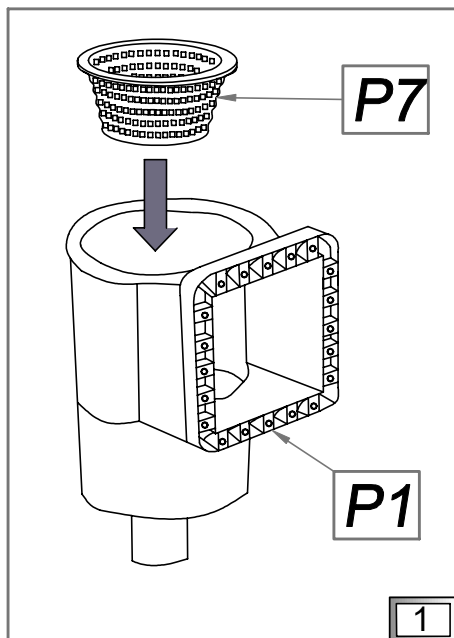
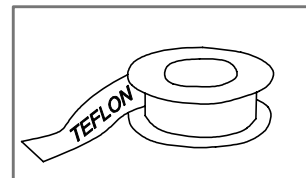
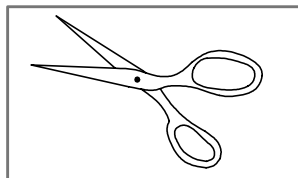
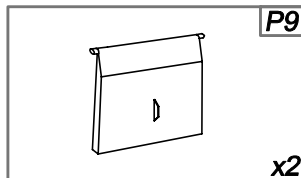
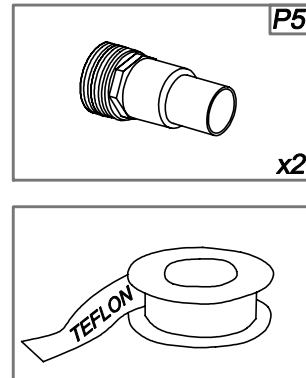
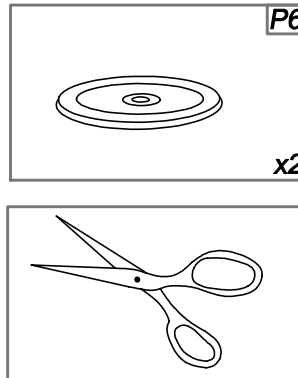
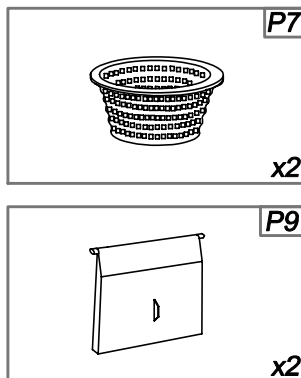
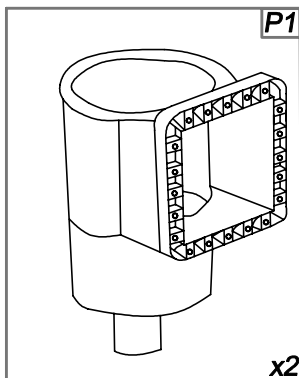

**PL** Struktura drewniana

**GB** Wooden structure

**DE** Holzstruktur

**FR** La structure bois

**IT** Struttura in legno

**NL** Houten structuur



**PL** Ułożenie kolejnych warstw. Zamontuj skimmer (P0).

**FR** La pose des couches suivantes. Montez le skimmer (P0).

**GB** Arrangement of layers . Mount a skimmer (P0).

**IT** La disposizione degli strati successivi. Montare lo skimmer (P0).

**DE** Anordnung der Schichten. Befestigen Sie den Skimmer (P0).

**NL** Opbouw van de lagen. Monteer de skimmer (P0).

**IX**

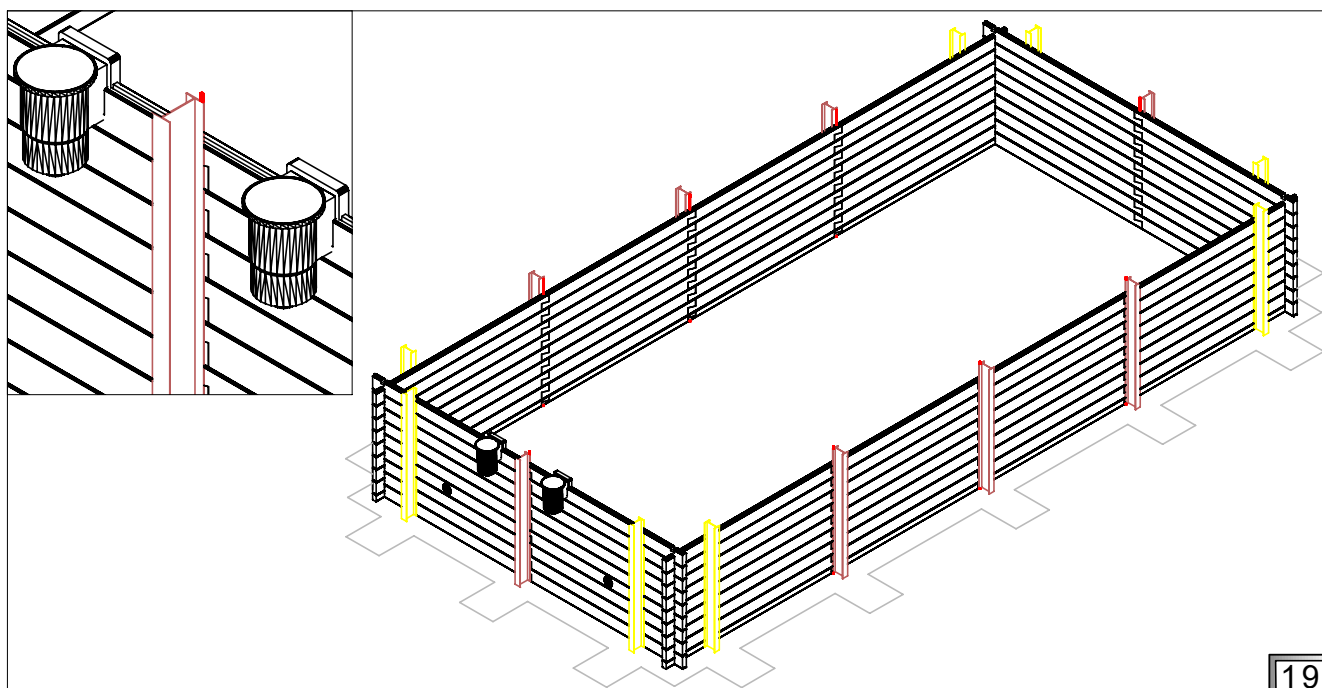
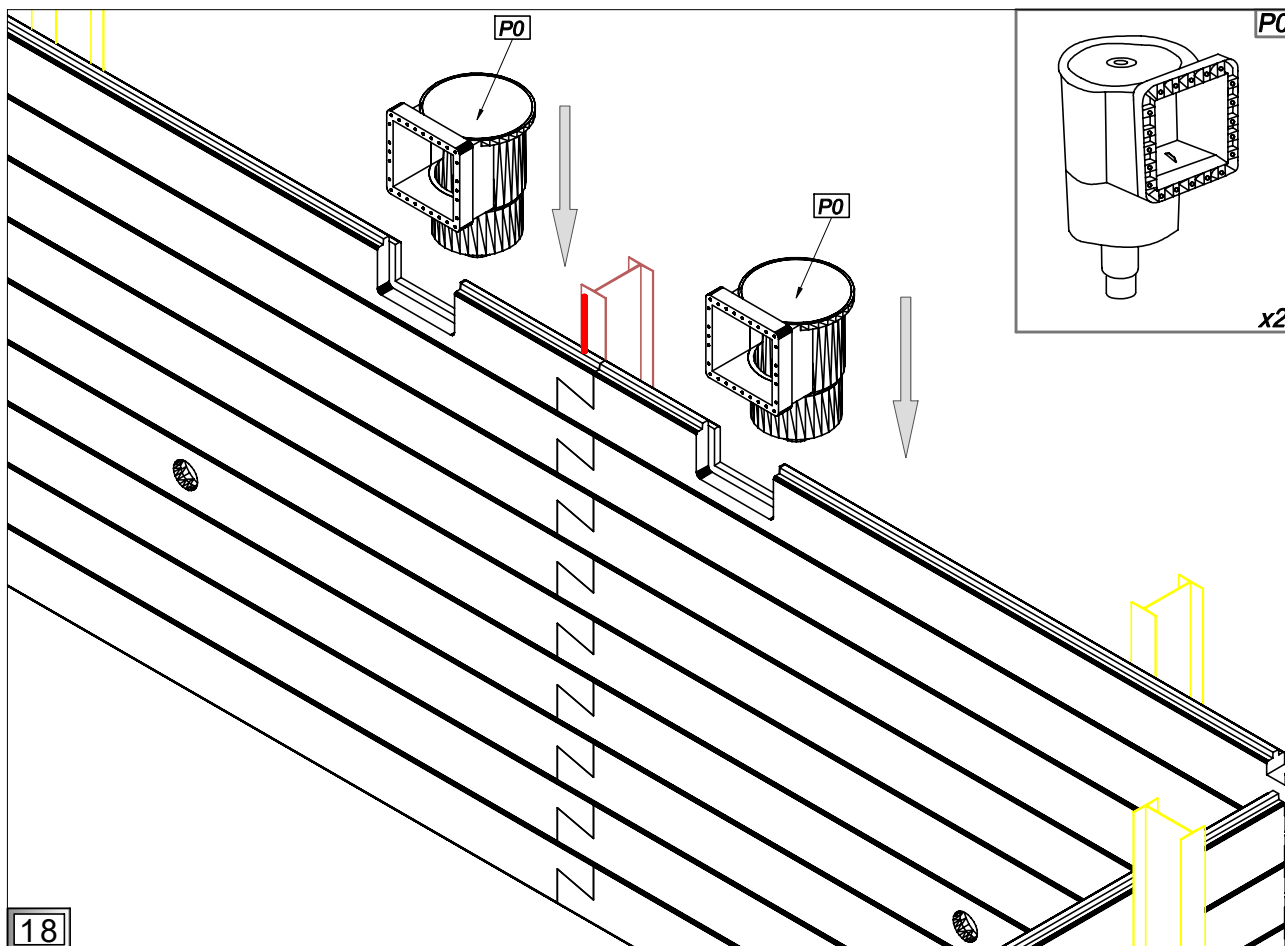

**PL** Struktura drewniana

**GB** Wooden structure

**DE** Holzstruktur

**FR** La structure bois

**IT** Struttura in legno

**NL** Houten structuur



**PL** Ułożenie kolejnych warstw. Sprawdzaj przekątną po każdej ułożonej warstwie.

**FR** L'assemblage des couches suivantes. Vérifiez la conformité des diagonales après la pose de chaque couche.

**GB** Arrangement of layers. Check diagonals after having arranged each layer.

**IT** La messa degli strati successivi. Trova la diagonale dopo ogni strato.

**DE** Anordnung der Schichten. Überprüfen Sie die Diagonalen nachdem Sie jede Schichte angeordnet haben.

**NL** Opbouw van de lagen. Controleer de diagonalen na het aanbrengen van elke laag.

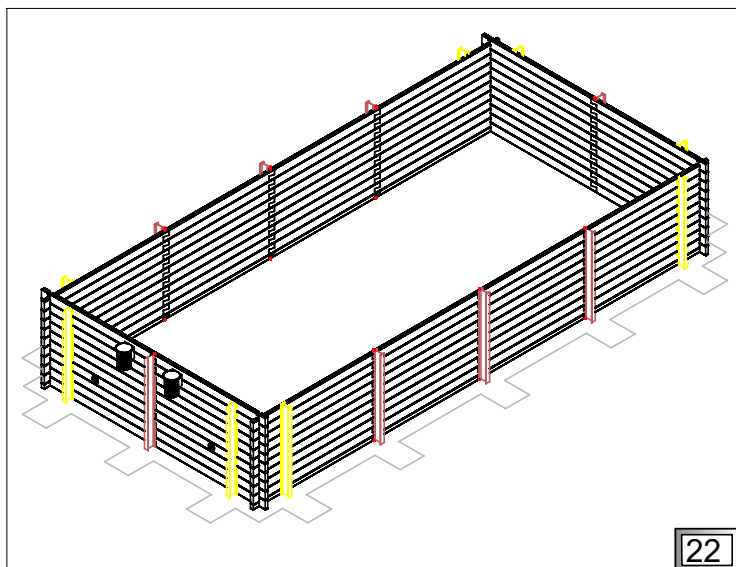
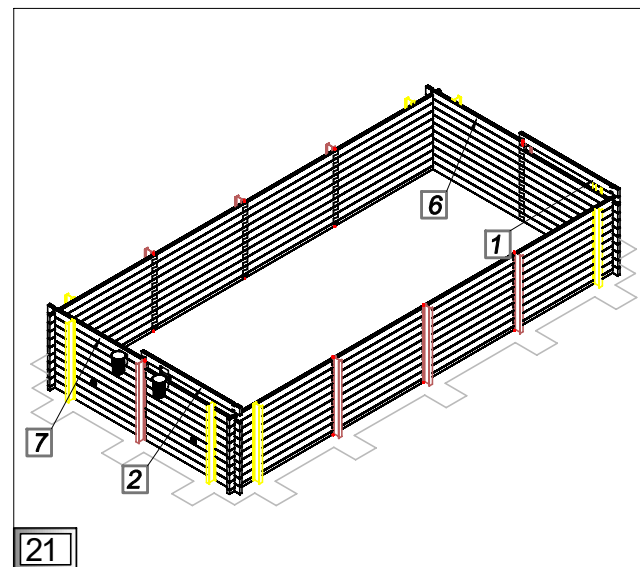
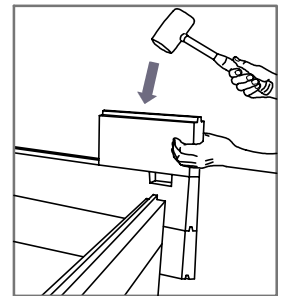
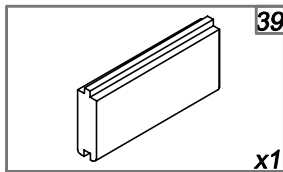
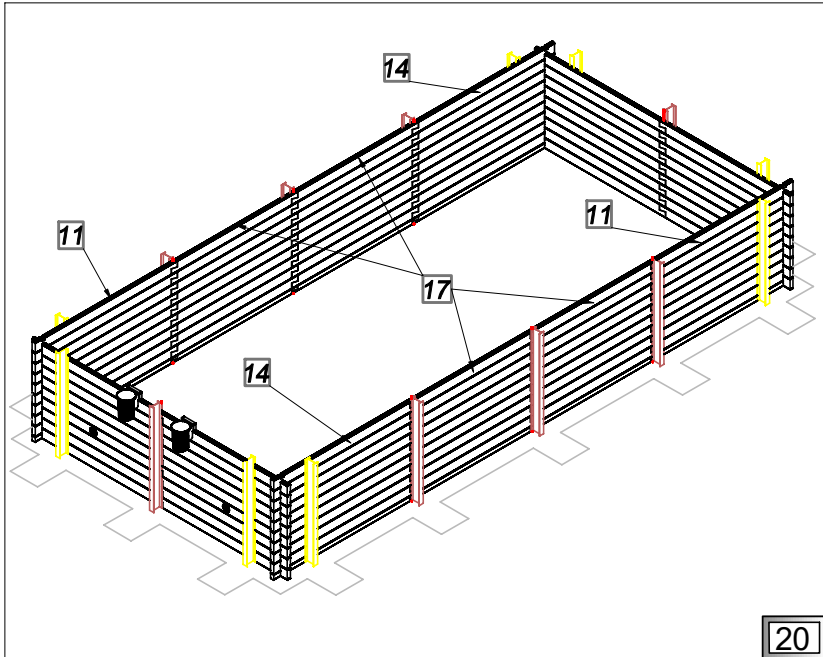
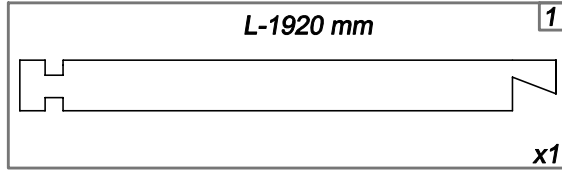
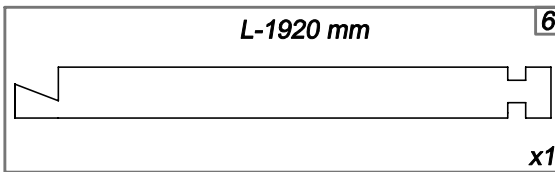
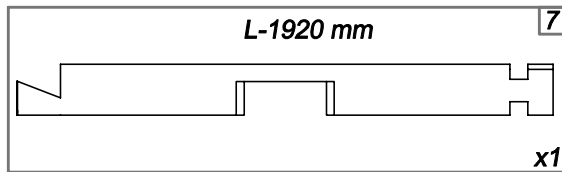
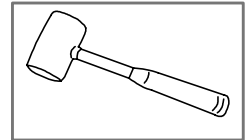
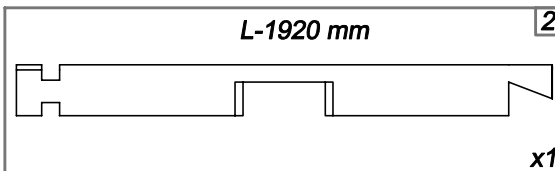
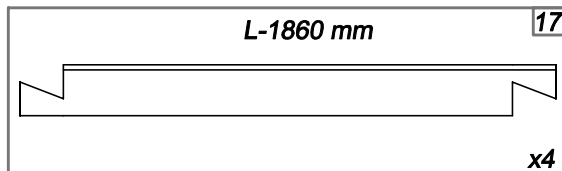
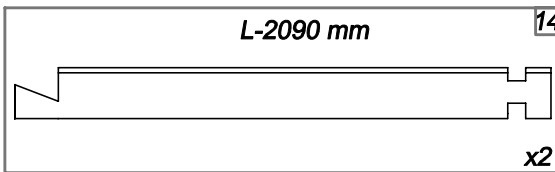
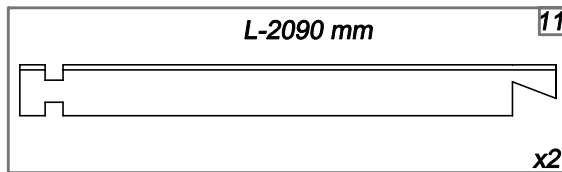

X

20

21

22

**PL** Struktura drewniana

**GB** Wooden structure

**DE** Holzstruktur

**FR** La structure bois

**IT** Struttura in legno

**NL** Houten structuur



**PL** Ułożenie kolejnych warstw. Sprawdzaj przekątną po każdej ułożonej warstwie.

**FR** L'assemblage des couches suivantes. Vérifiez la conformité des diagonales après la pose de chaque couche.

**GB** Arrangement of layers. Check diagonals after having arranged each layer.

**IT** La messa degli strati successivi. Trova la diagonale dopo ogni strato.

**DE** Anordnung der Schichten. Überprüfen Sie die Diagonalen nachdem Sie jede Schichte angeordnet haben.

**NL** Opbouw van de lagen. Controleer de diagonalen na het aanbrengen van elke laag.

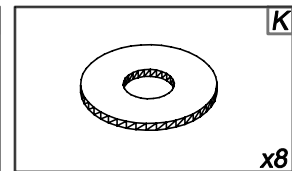
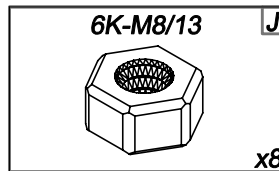
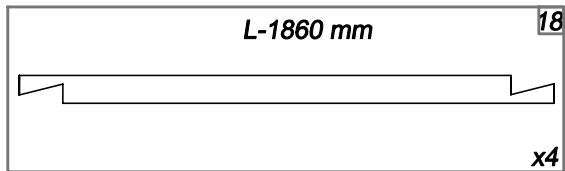
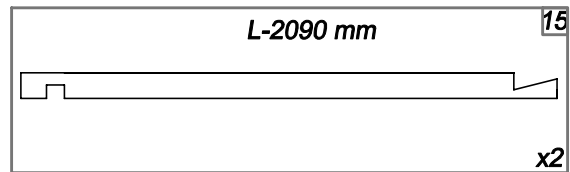
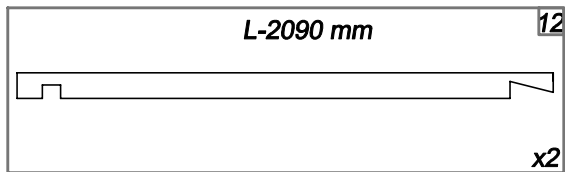

XI

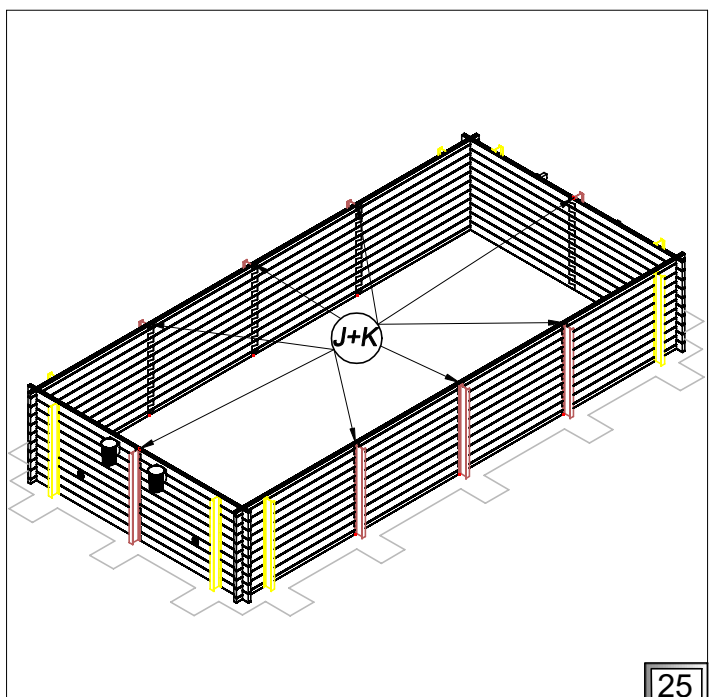
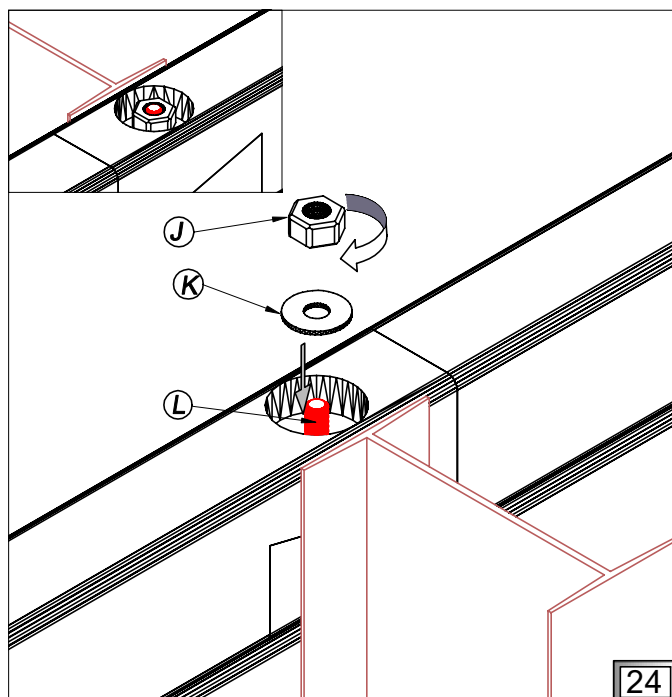
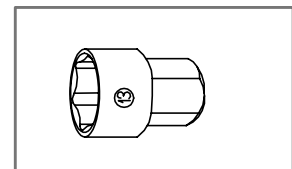
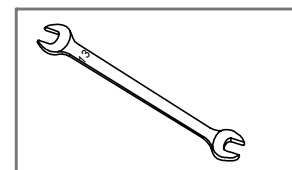
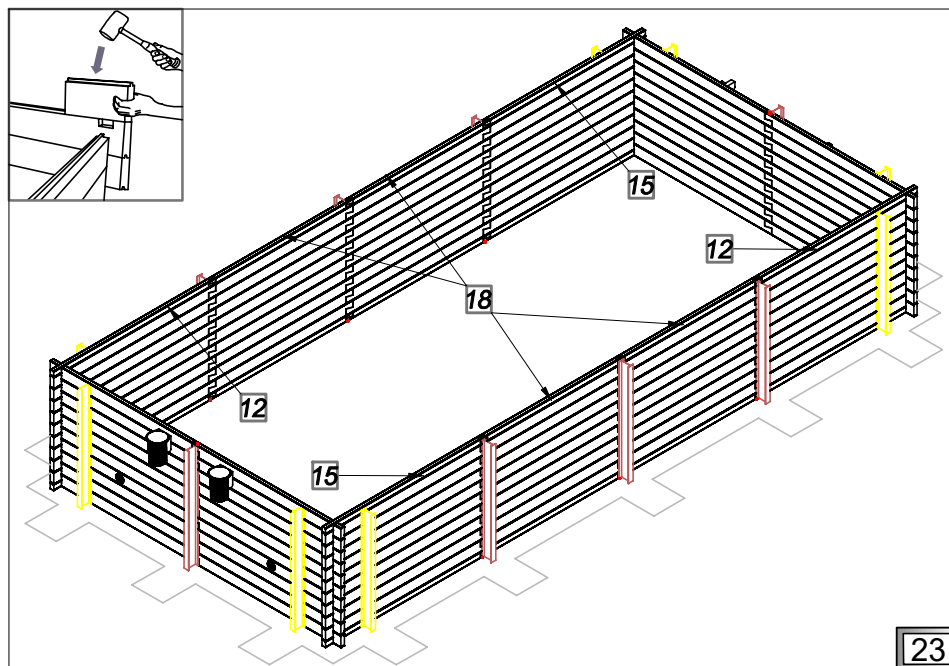

**PL** *Struktura drewniana*

**GB** *Wooden structure*

**DE** *Holzstruktur*

**FR** *La structure bois*

**IT** *Struttura in legno*

**NL** *Houten structuur*



**PL** Ułożenie kolejnych warstw. Sprawdzaj przekątną po każdej ułożonej warstwie.

**FR** L'assemblage des couches suivantes. Vérifiez la conformité des diagonales après la pose de chaque couche.

**GB** Arrangement of layers. Check diagonals after having arranged each layer.

**IT** La messa degli strati successivi. Trova la diagonale dopo ogni strato.

**DE** Anordnung der Schichten. Überprüfen Sie die Diagonalen nachdem Sie jede Schichte angeordnet haben.

**NL** Opbouw van de lagen. Controleer de diagonalen na het aanbrengen van elke laag.

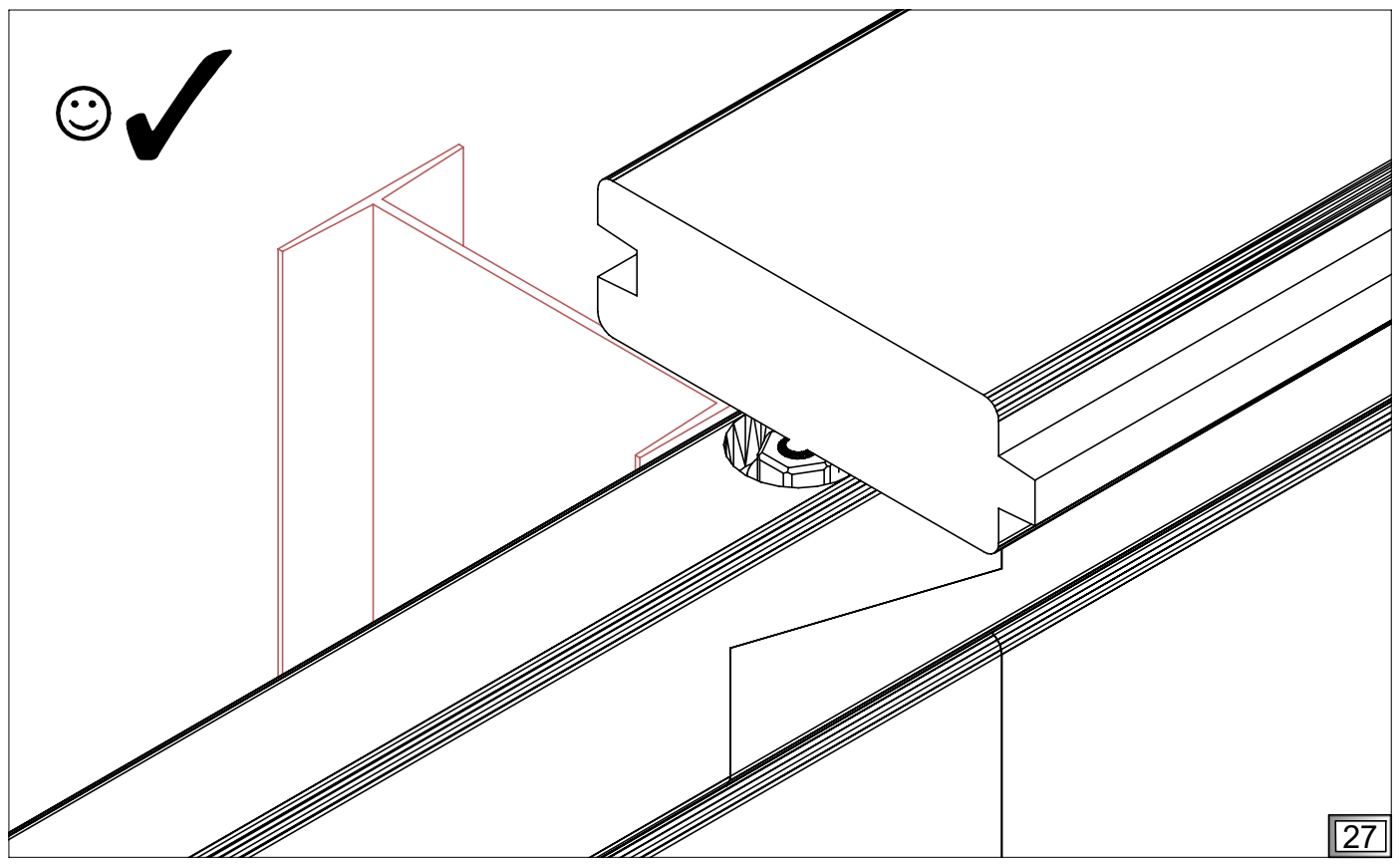
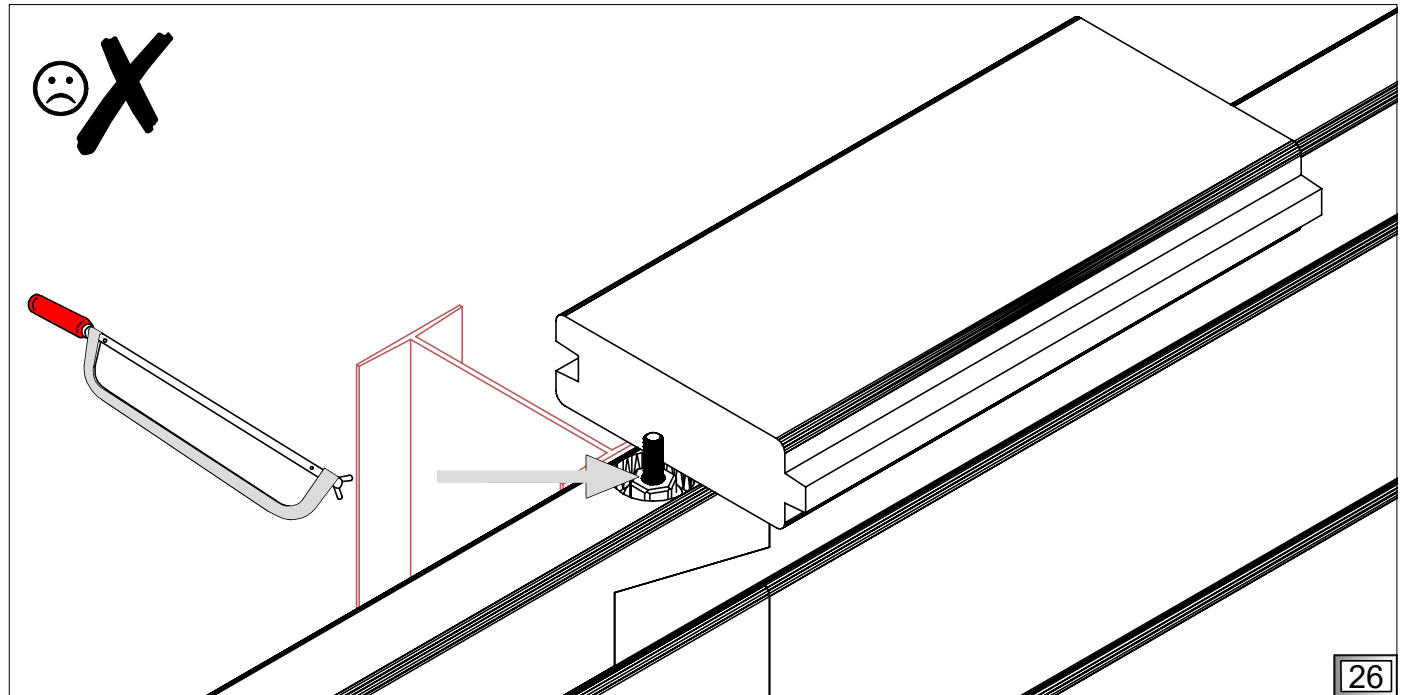
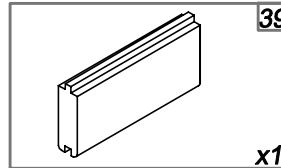
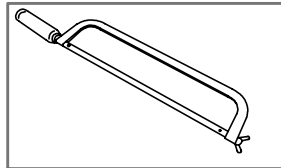

**(PL)** Struktura drewniana

**(GB)** Wooden structure

**(DE)** Holzstruktur

**(FR)** La structure bois

**(IT)** Struttura in legno

**(NL)** Houten structuur



- (PL)** Montaż wspornika schodów (31).
- (FR)** Le montage du renfort d'escalier (31).
- (GB)** Installation of stairs support (31).
- (IT)** Montaggio delle scale a sbalzo (31).
- (DE)** Montage von Treppenstützen (31).
- (NL)** Installatie van trappensteun (31).

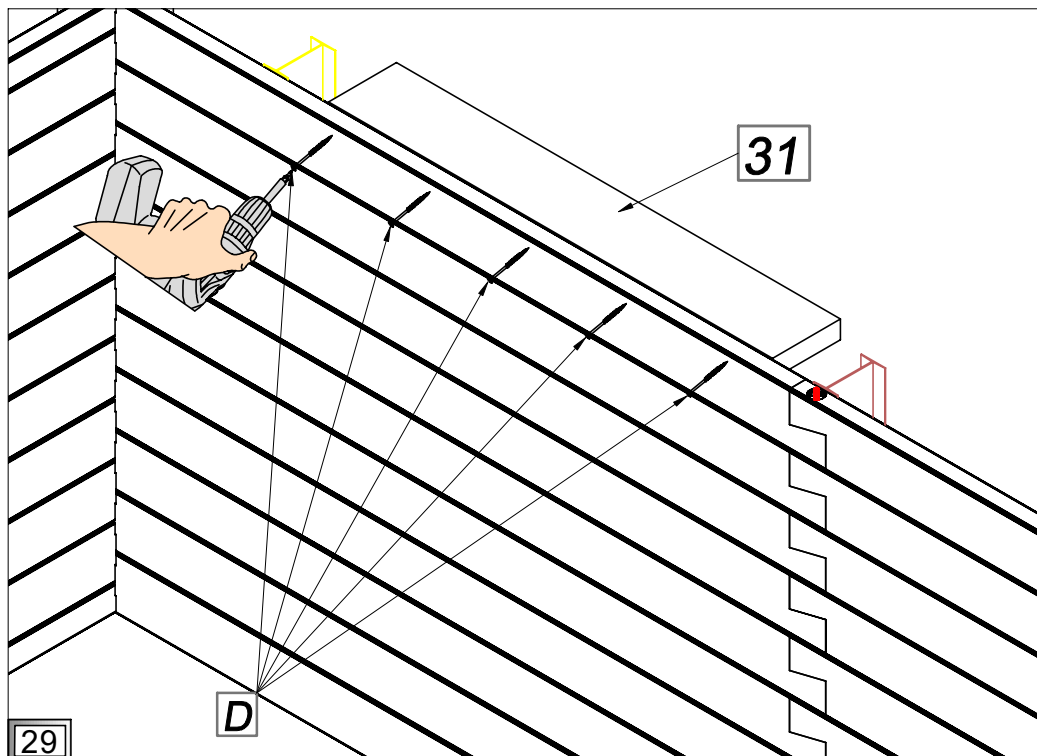
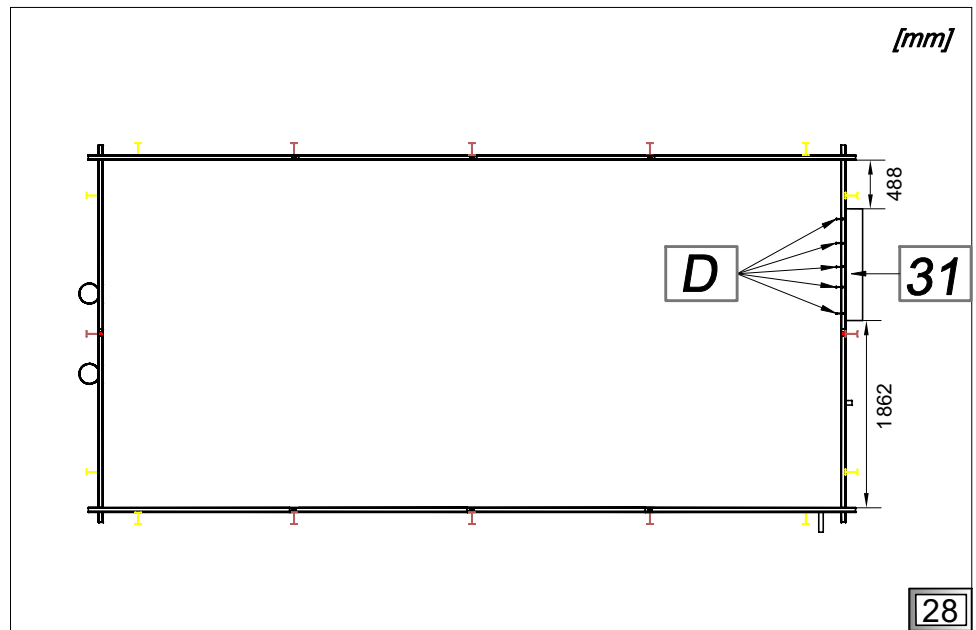
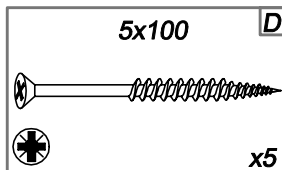
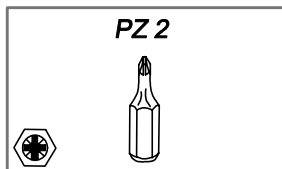
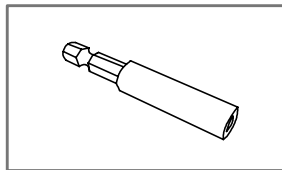
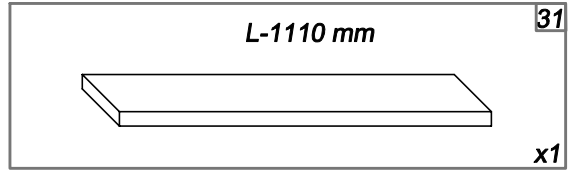
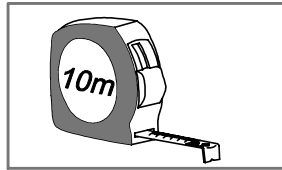
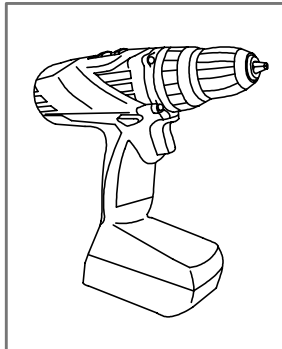

**PL** Struktura drewniana

**GB** Wooden structure

**DE** Holzstruktur

**FR** La structure bois

**IT** Struttura in legno

**NL** Houten structuur



**PL** Rozłożenie wsporników pionowych (32, 33) oraz konsol (37) według schematu.

**FR** La disposition des renforts verticaux (32,33) et des supports des margelles (37) d'après le schéma.

**GB** Arrangement of vertical supports (32,33) and consoles (37) according to the drawing.

**IT** La distribuzione degli sbalzi verticali (32,33) e delle console (37), secondo lo schema.

**DE** Anordnung der vertikalen Stützen (32,33) und Konsolen (37) gemäß der Zeichnung.

**NL** Opstelling van verticale steunen (32,33) en consoles (37) volgens de tekening.

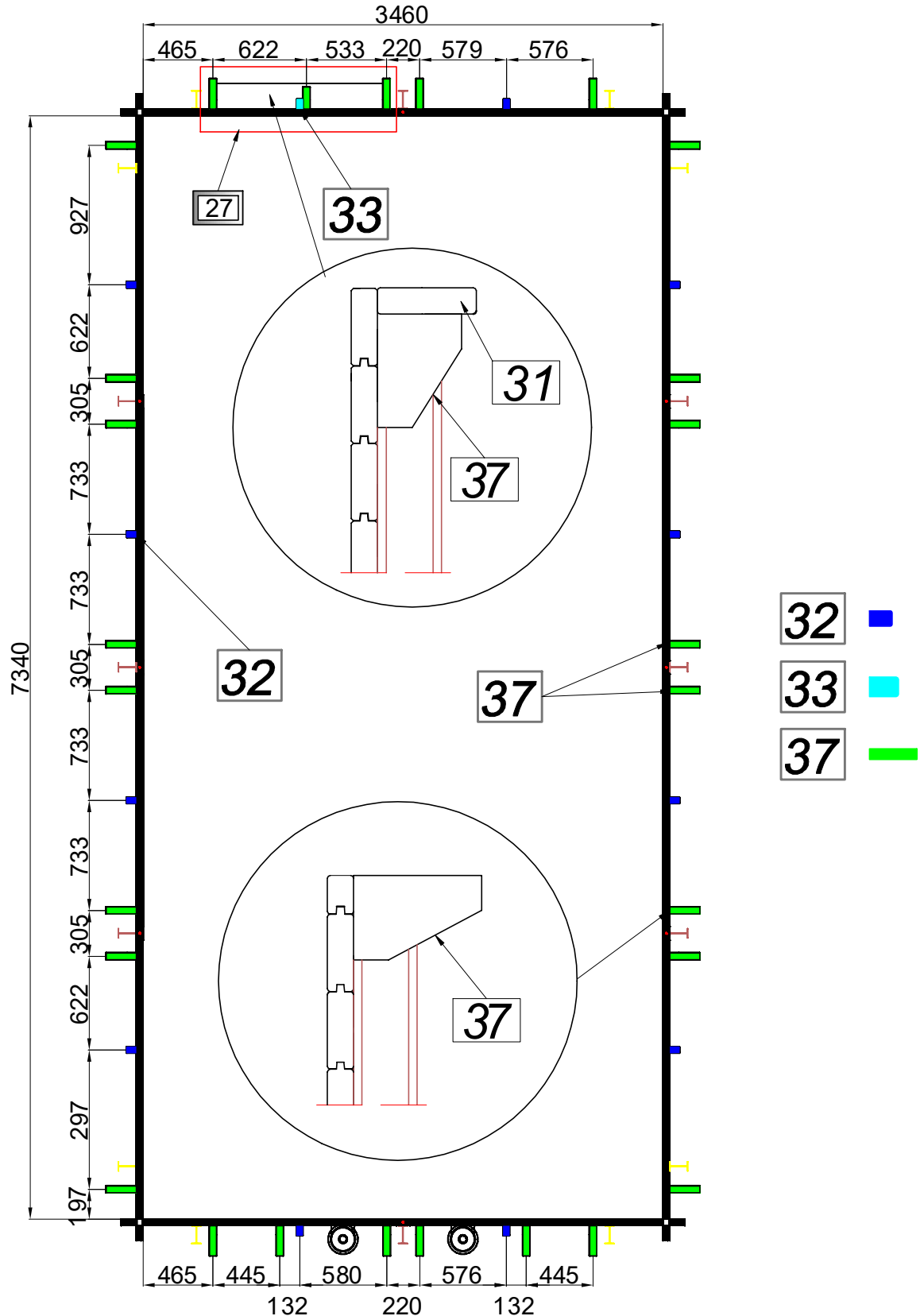

**PL** *Struktura drewniana*

**GB** *Wooden structure*

**DE** *Holzstruktur*

**FR** *La structure bois*

**IT** *Struttura in legno*

**NL** *Houten structuur*



**PL** Montaż konsol (37). Konsole montowane pod wspomnieniem schodów (31) według rysunku 34.

**FR** Montage des supports des margelles (37). Montez les supports des margelles sous le renfort d'escalier (31) d'après le dessin 34.

**GB** Installation of consoles (37). Consoles under ladder support (31) installed according to the drawings 34.

**IT** Il montaggio di console (37). Console sono montate sotto lo sbalzo della scala (31), come mostrato sul disegno 34.

**DE** Installation der Konsolen (37). Konsolen unter Leiterabstützung installiert (31) Schrauben entsprechend der Zeichnung anordnen 34.

**NL** Installatie van consoles (37). Consoles geïnstalleerd onder laddersteun (31) breng de schroeven aan volgens de tekening 34.

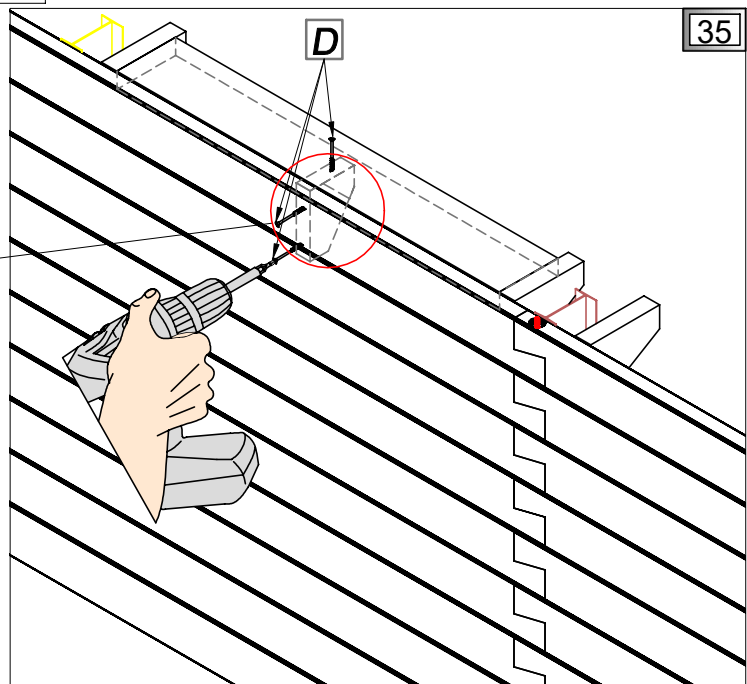
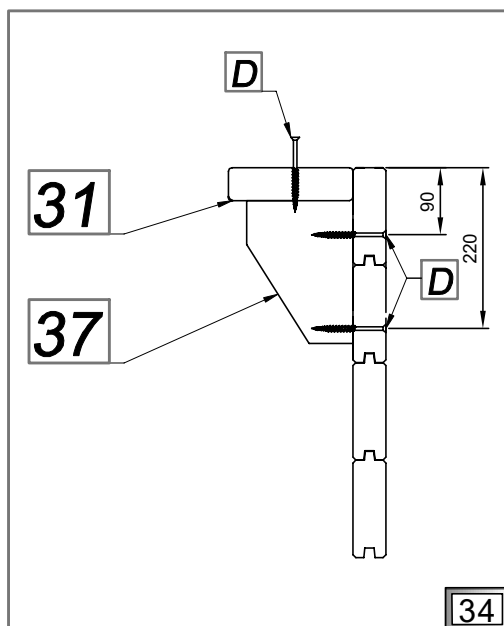
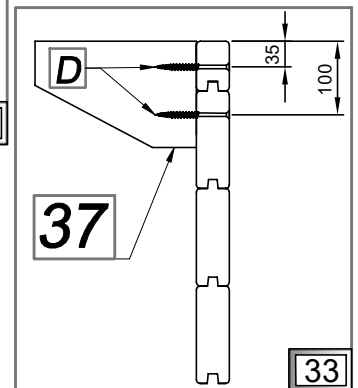
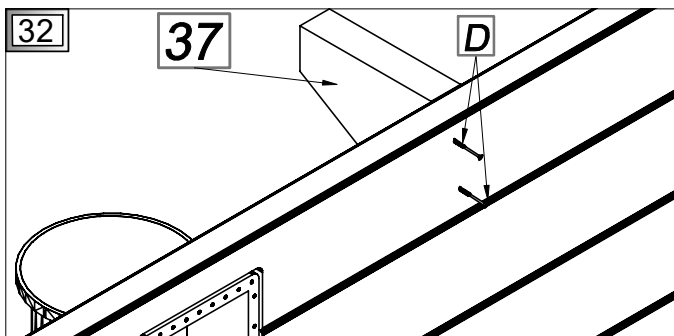
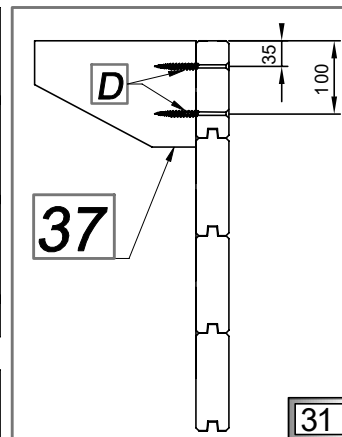
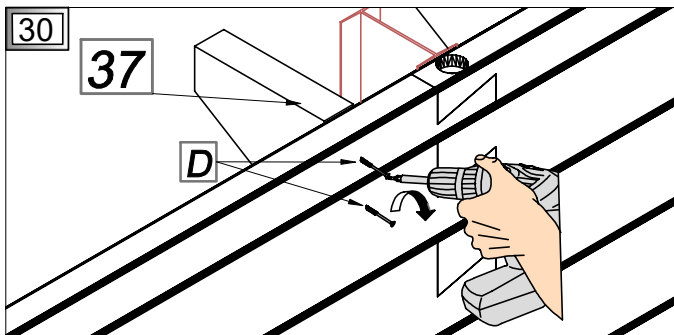
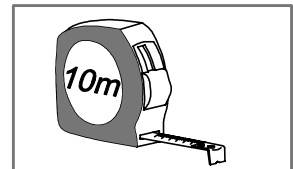
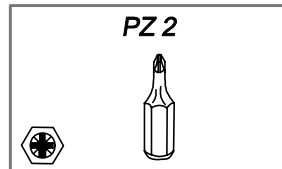
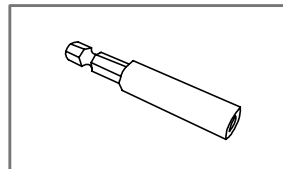
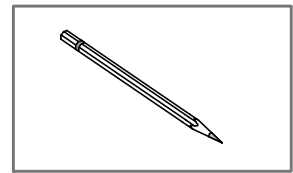
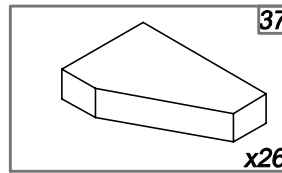
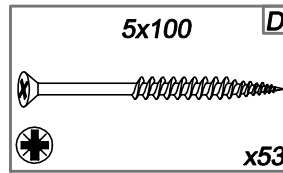
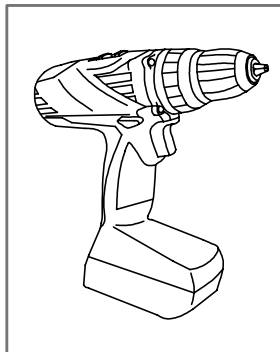



**(PL)** Struktura drewniana

**(GB)** Wooden structure

**(DE)** Holzstruktur

**(FR)** La structure bois

**(IT)** Struttura in legno

**(NL)** Houten structuur



**(PL)** Montaż wsporników pionowych (32). Wkręty rozmieszczaj według rysunku 37,38.

**(FR)** Le montage des renforts verticaux (32). Disposer les vis selon le dessin 37,38.

**(GB)** Installation of vertical supports (32). Arrange screws according to the drawing 37,38.

**(IT)** Montaggio degli sbalzi verticali (32). Mettere viti secondo il disegno 37,38.

**(DE)** Installation von vertikalen Stützen (32). Schrauben entsprechend der Zeichnung anordnen 37,38.

**(NL)** Installatie van verticale steunen (32). Breng de schroeven aan volgens de tekening 37,38.

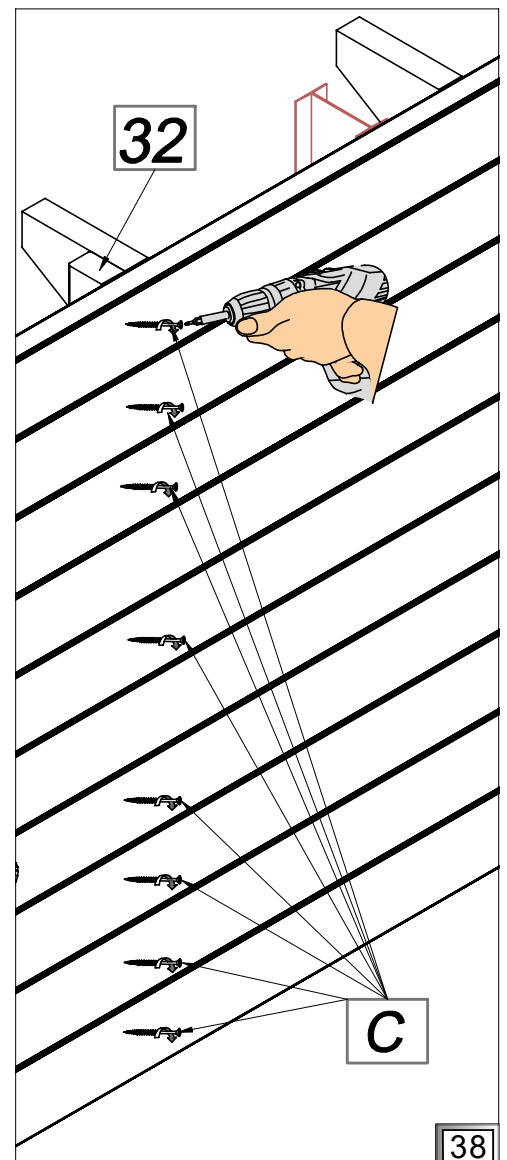
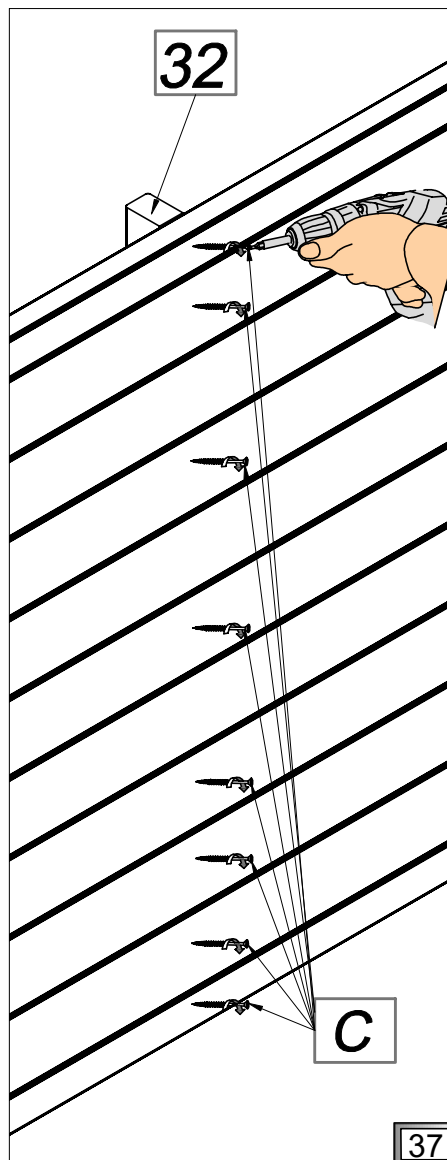
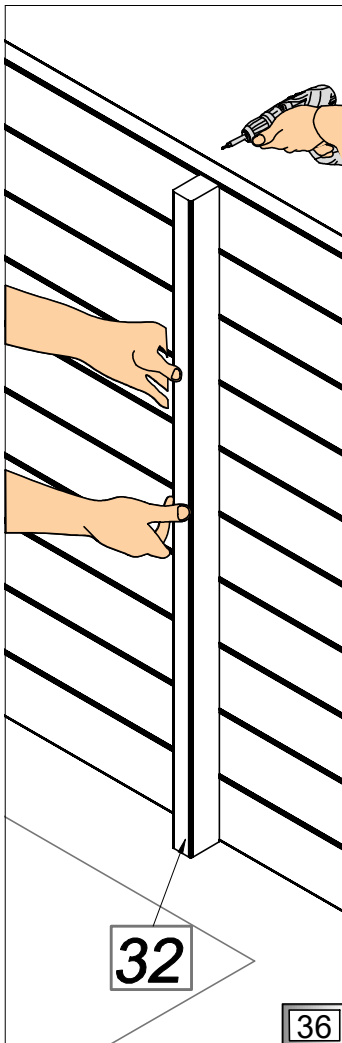
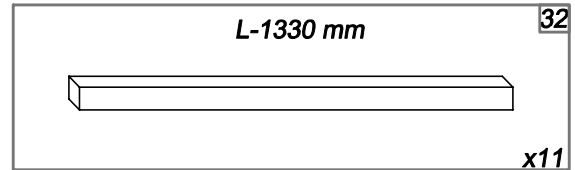
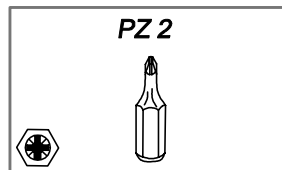
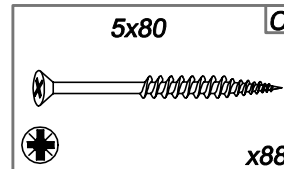
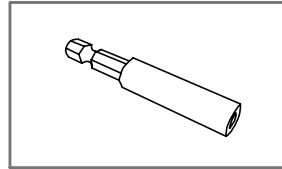
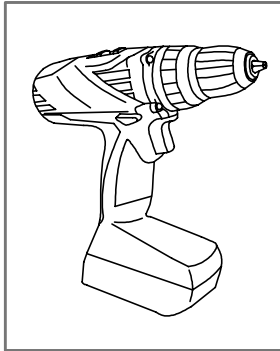

**(PL)** Struktura drewniana

**(GB)** Wooden structure

**(DE)** Holzstruktur

**(FR)** La structure bois

**(IT)** Struttura in legno

**(NL)** Houten structuur



**(PL)** Montaż wsporników pionowych (33) pod wspornikiem schodów (31).

**(FR)** Montage des renforts verticaux (33) sous le renfort d'escalier (31).

**(GB)** Installation of vertical supports (33) under the ladder support (31).

**(IT)** Installazione degli sbalzi verticali (33) sotto lo sbalzo delle scale (31).

**(DE)** Installation von vertikalen Stützen (33) unter der Leiterunterstützung (31).

**(NL)** Installatie van verticale steunen (33) onder de laddersteun (31).

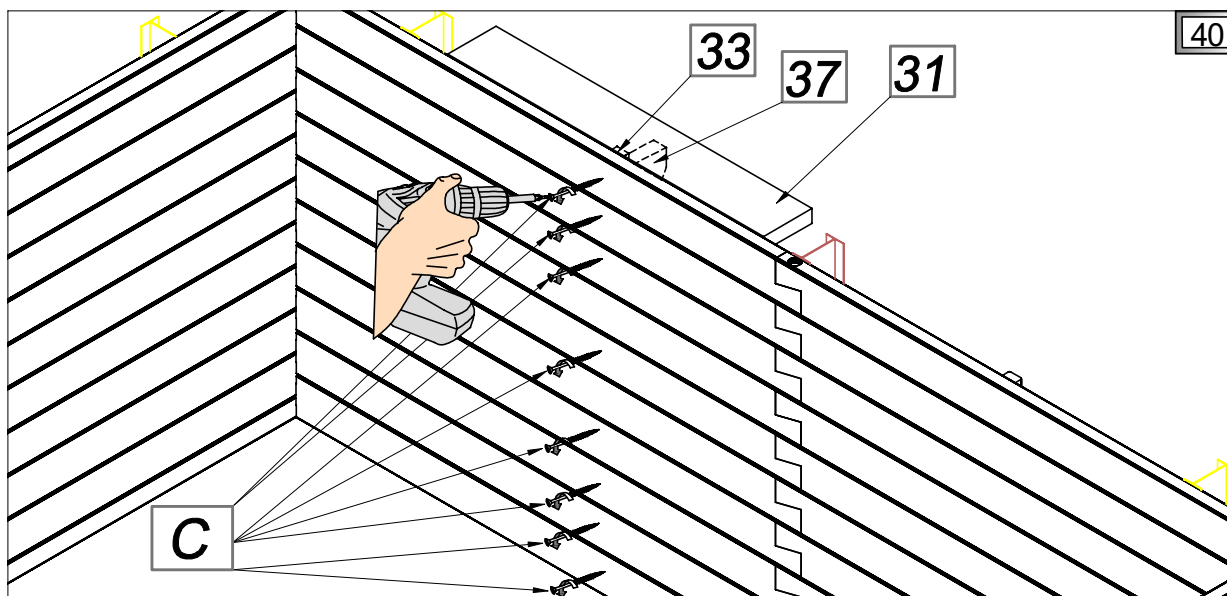
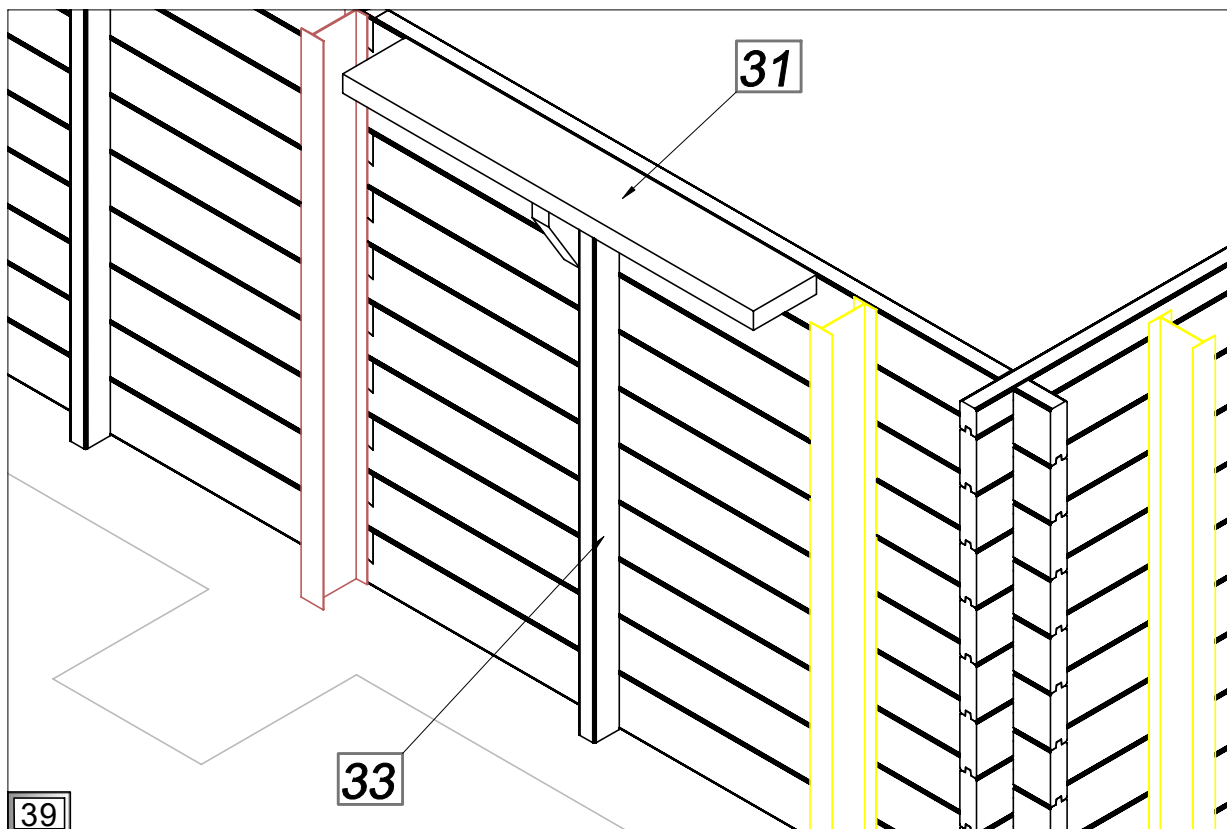
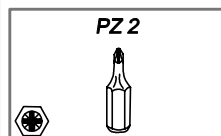
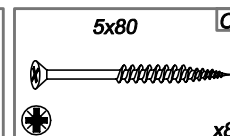
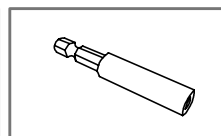
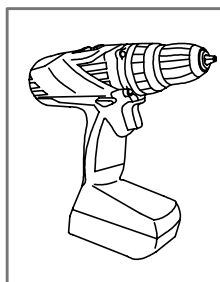
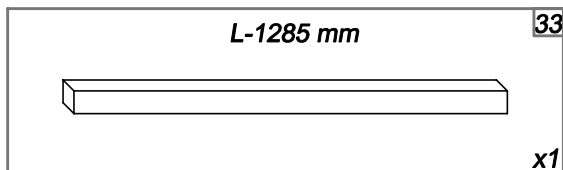

**PL** Struktura drewniana

**GB** Wooden structure

**DE** Holzstruktur

**FR** La structure bois

**IT** Struttura in legno

**NL** Houten structuur



**PL** Maskowanie słupków metalowych 2T (T1) maskownicami (34, 35).

**FR** La fixation des caches (34, 35) pour les poteaux métalliques 2T (T1).

**GB** Covering steel bars 2T (T1) with masking elements (34, 35).

**IT** Mascherare i pilastri di metallo 2T (T1) con i mascherini (34, 35).

**DE** Stahlstangen 2T (T1) mit Abdeckelementen abdecken. (34, 35).

**NL** Bedekking van stalen stangen 2T (T1) met maskeerelementen (34,35).

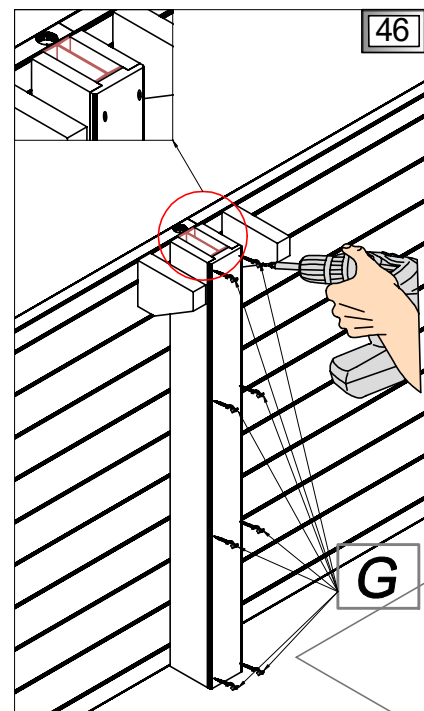
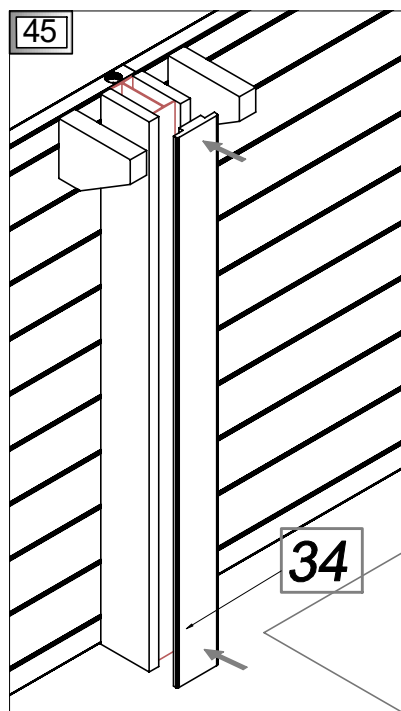
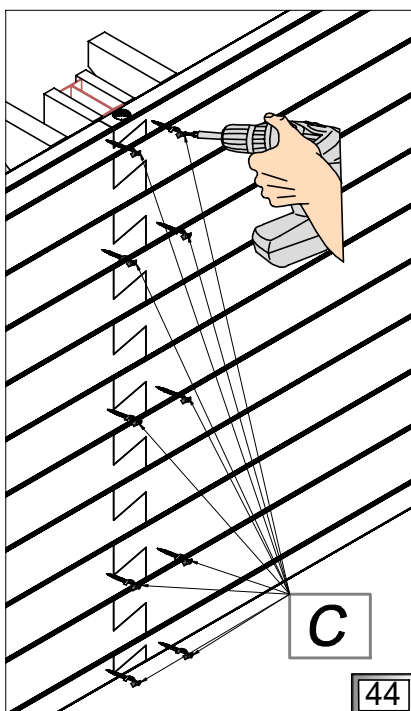
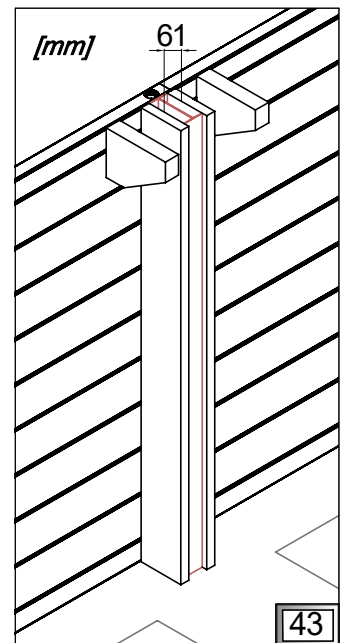
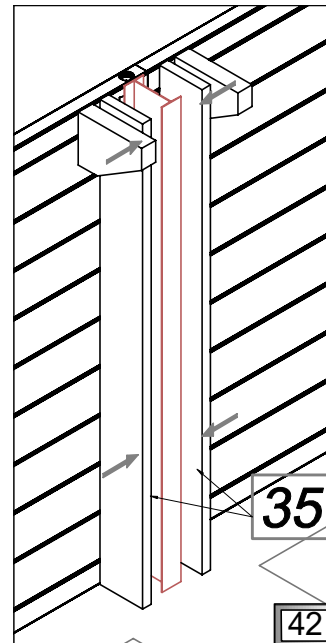
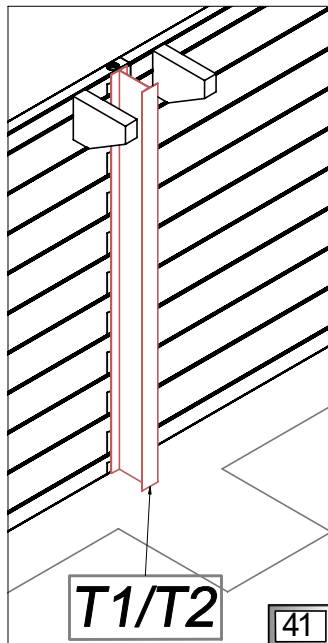
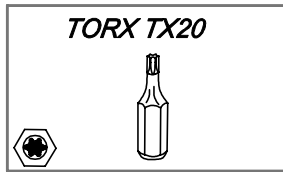
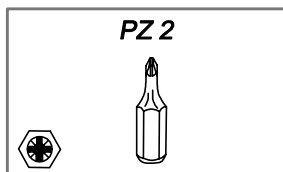
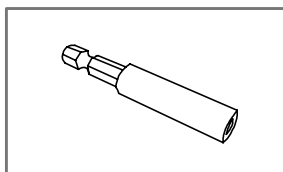
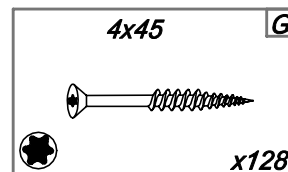
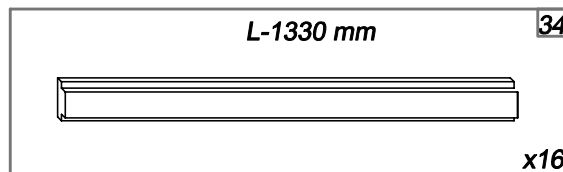
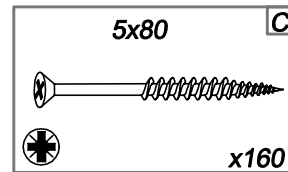
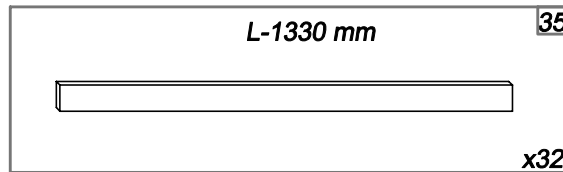
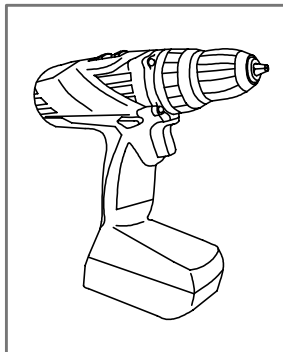

**PL** Struktura drewniana

**GB** Wooden structure

**DE** Holzstruktur

**FR** La structure bois

**IT** Struttura in legno

**NL** Houten structuur



- PL** Montaż maskownicy (36).
- FR** Montage des caches (36).
- GB** Installation of the masking element (36).
- IT** Montaggio del mascherino (36).
- DE** Installation der Abdeckelemente (36).
- NL** Installatie van het maskeerelement (36).

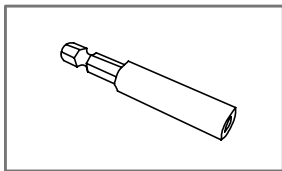
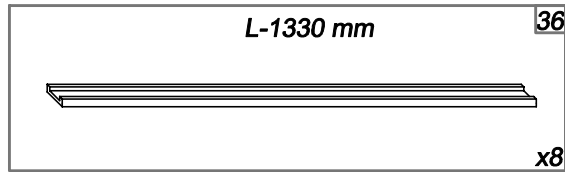
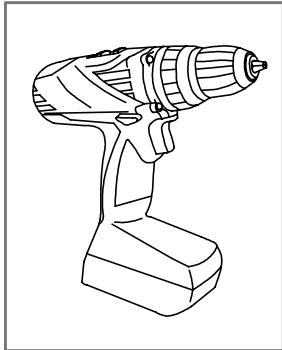

TORX TX20

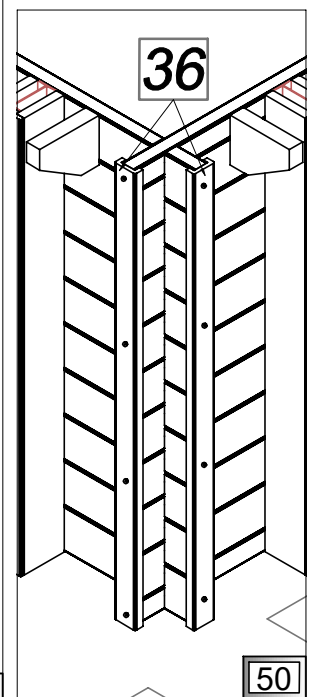
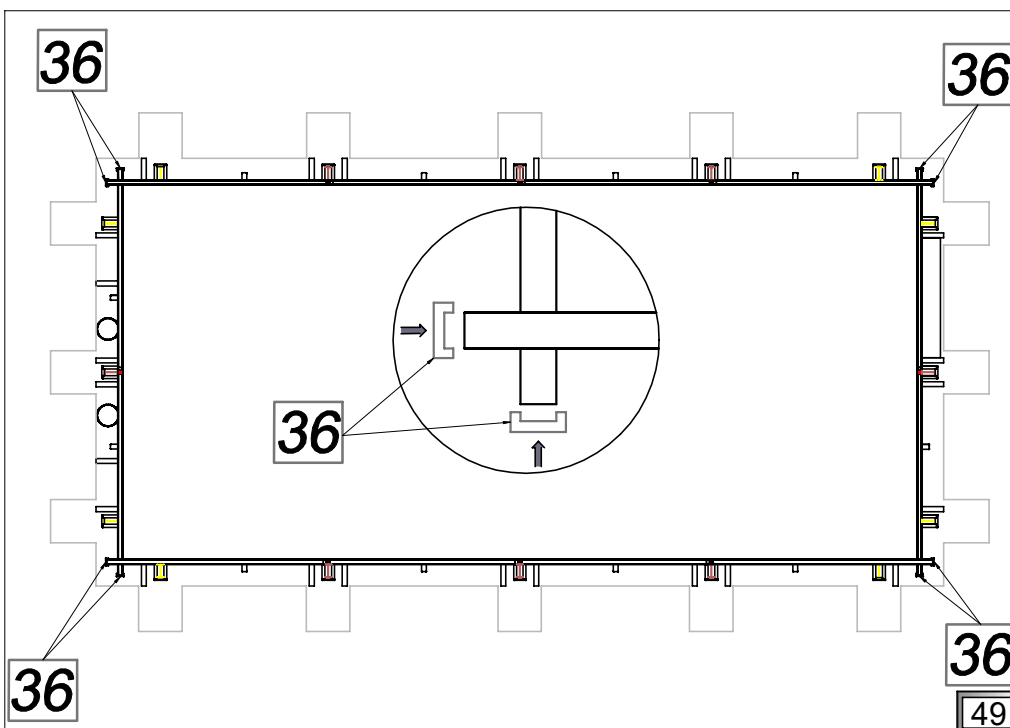
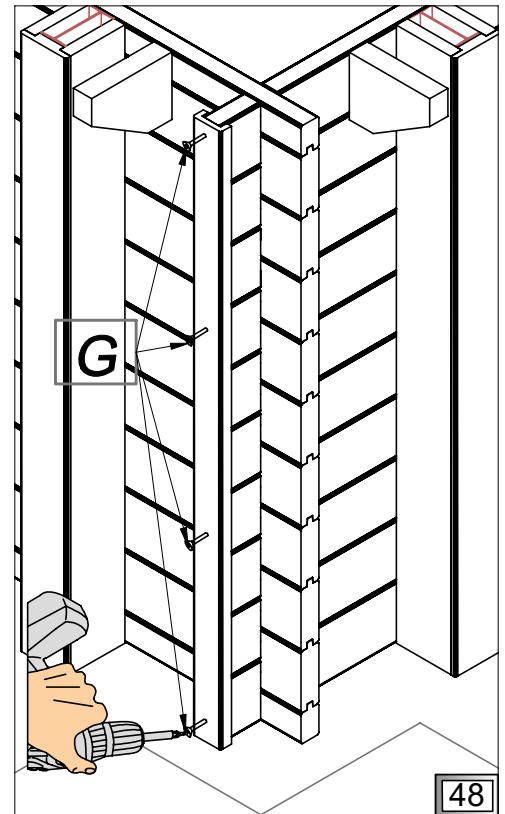
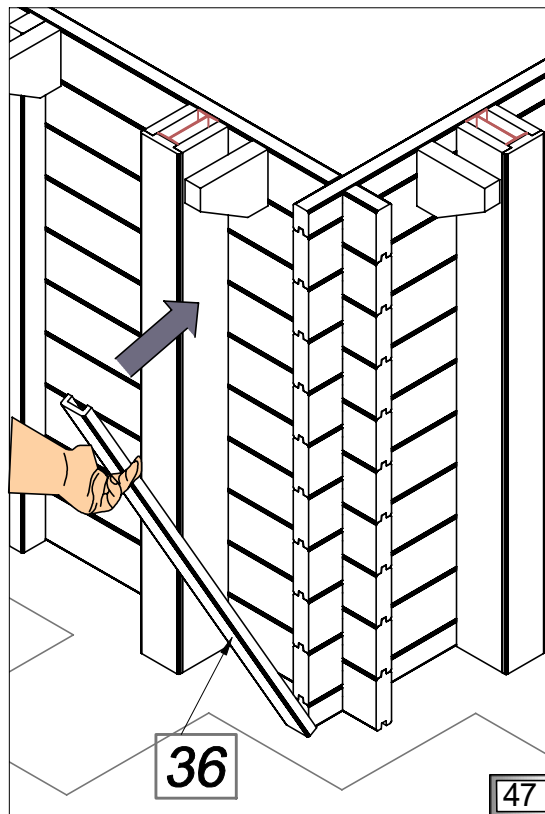
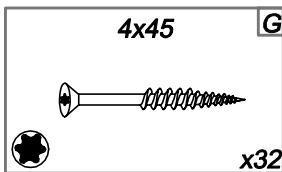

**PL** Geowłóknina

**GB** Geotextile

**DE** Geotextilien

**FR** Géotextile

**IT** Geotessile

**NL** Geotextiel



**PL** Rozłożenie geowłókniny (S). Nakleić włókninę na wewnętrzną stronę basenu za pomocą taśmy 2-stronnej bądź kleju.

**FR** La pose du feutre (S). Collez le feutre a l'intérieur de la structure à l'aide de colle ou de ruban adhésif double face.

**GB** The distribution of geotextile (S). Glue the geotextile to the inner side of pool wall. Use double-side tape or glue.

**IT** La distribuzione di geotessile (S). Incolli il geotessile al lato interno di muro di piscina. Usa nastro a due facce o colla.

**DE** Verteilung von Geotextil (S). Kleben Sie das Geotextil an die Innenseite der Poolwand. Verwenden Sie doppelseitiges Klebeband oder Kleber.

**NL** Distributie van geotextiel (S). Lijm het geotextiel aan de binnenkant van de zwembadwand. Gebruik dubbelzijdige tape of lijm.

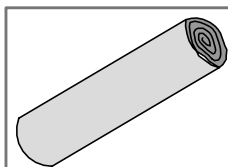

S

x1



Taśma dwustronna  
Double-sided  
Duct tape

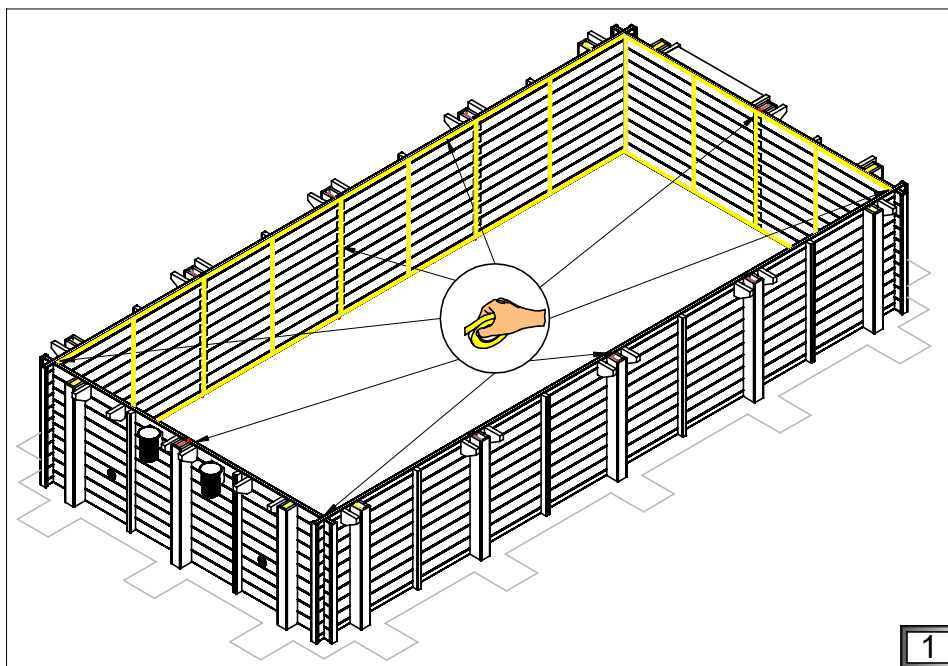
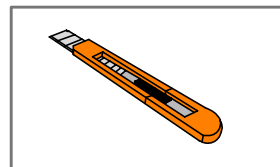
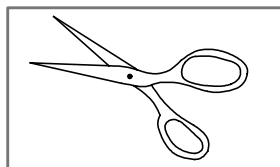

1

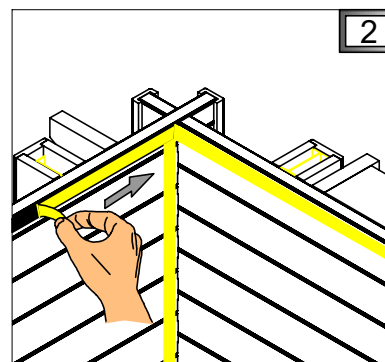

2

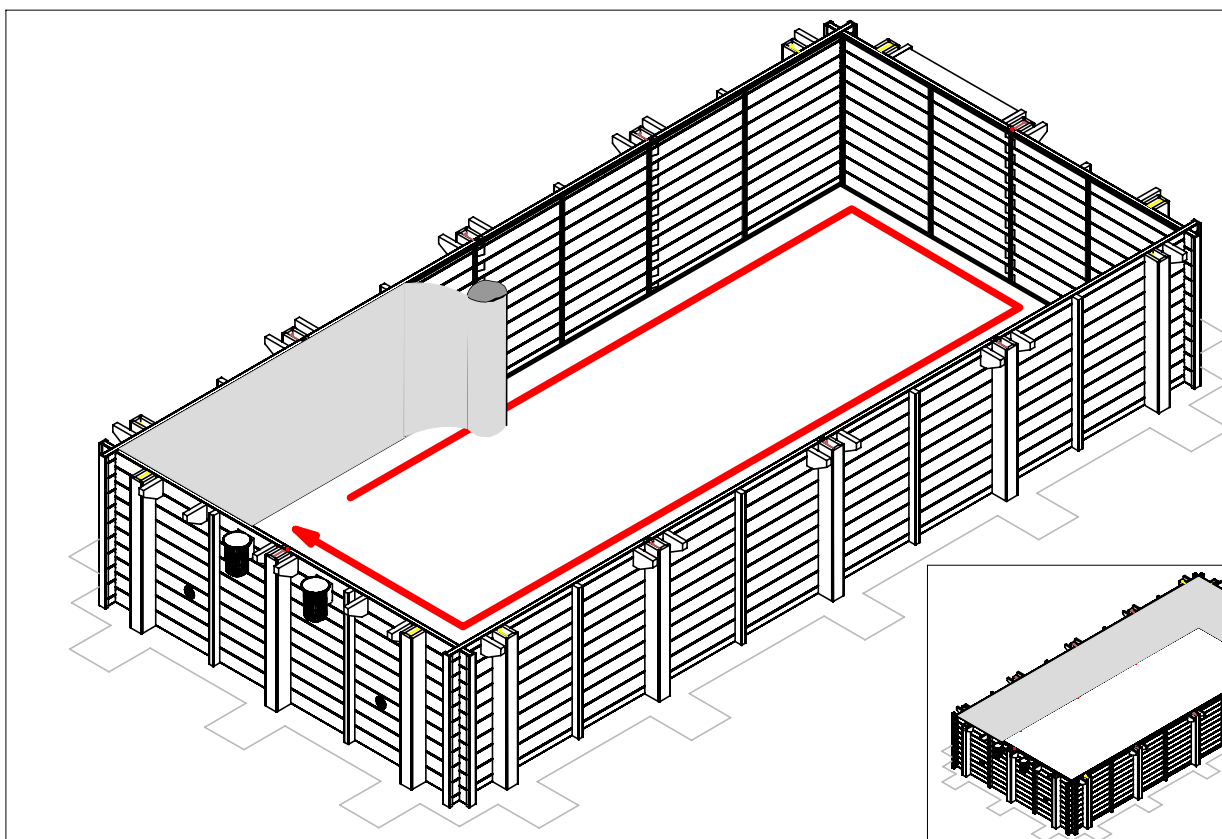

3

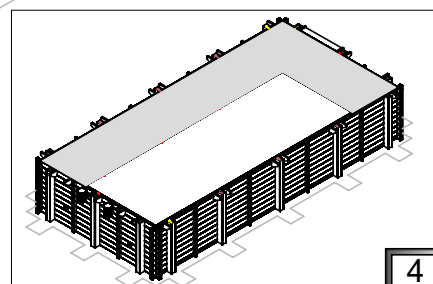

4

**(PL)** Profile PVC

**(GB)** PVC profiles

**(DE)** PVC-Profile

**(FR)** Les profils PVC

**(IT)** Profili in PVC

**(NL)** PV-profielen



**(PL)** Profile PVC (M) przyciąć na wymiar. Wykonać otwory  $\varnothing$  2 mm wg schematu.

**(FR)** Coupez les profilés PVC (M) d'accrochage et faites les pré-perçements  $\varnothing$  2 mm d'après le schéma.

**(GB)** Cut PVC profiles (M) according to the drawing. Make holes  $\varnothing$  2 mm according to the scheme.

**(IT)** Profili in PVC (M) adottare alla dimensione. Eseguire due fori  $\varnothing$  2 mm secondo lo schema.

**(DE)** Schneiden Sie PVC-Profile (M) gemäß der Zeichnung ab. Machen Sie anhand des Schemas Löcher von  $\varnothing$  2 mm.

**(NL)** Snijd PVC-profielen (M) volgens de tekening. Maak gaten van  $\varnothing$  2 mm volgens het schema.

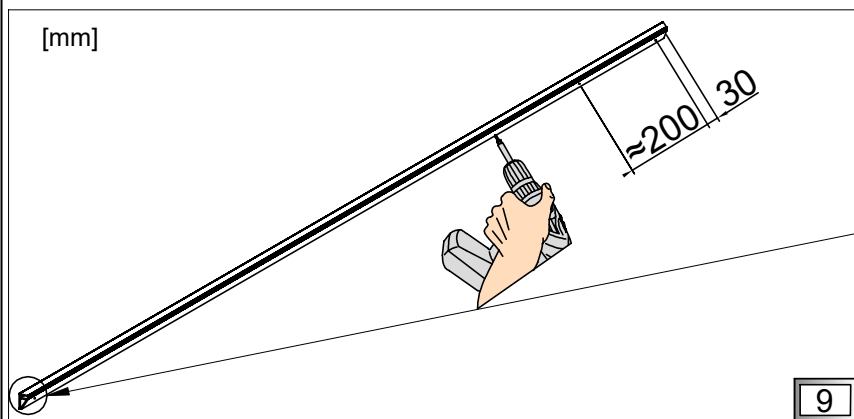
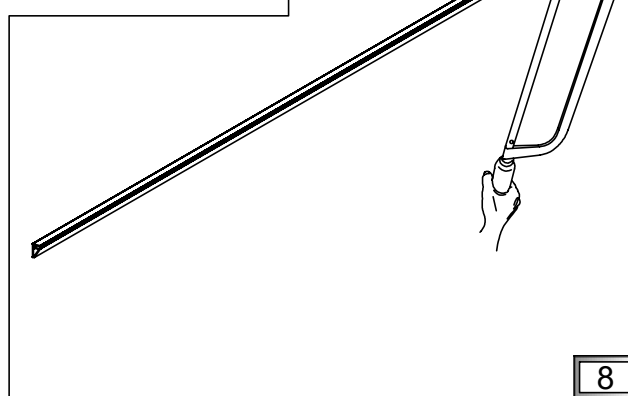
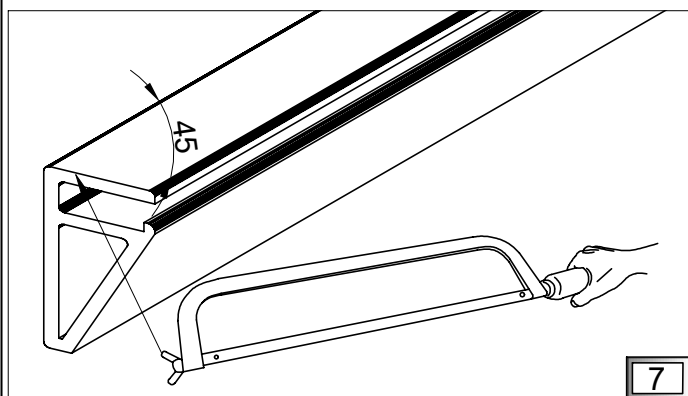
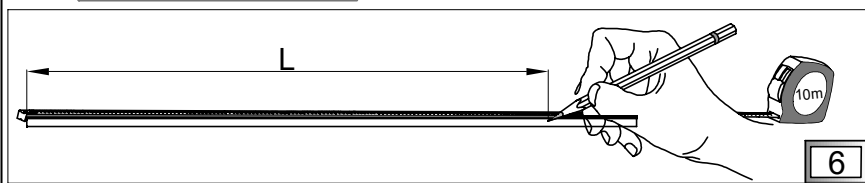
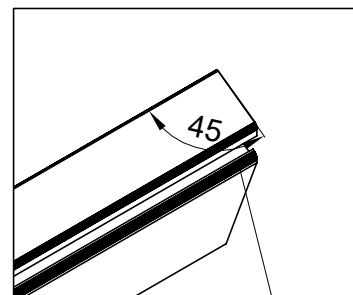
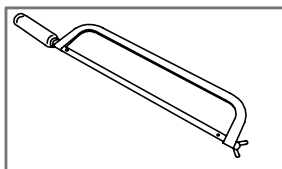
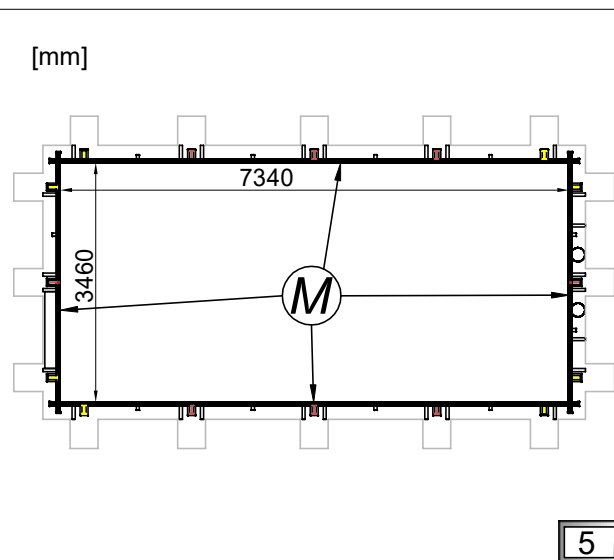
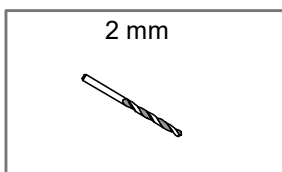
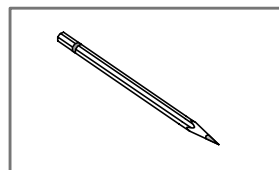
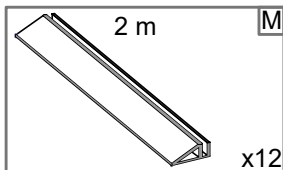
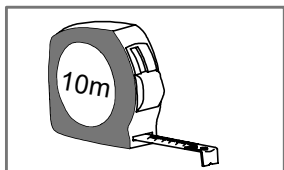
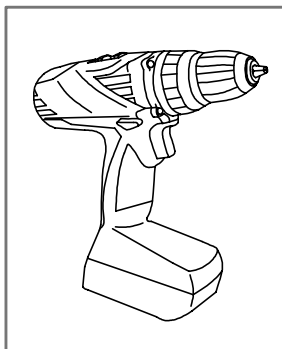

**(PL) Profile PVC**

**(GB) PVC profiles**

**(DE) PVC-Profile**

**(FR) Les profils PVC**

**(IT) Profili in PVC**

**(NL) PVC-profielen**



**(PL)** Montaż profili PVC (M) do struktury drewnianej. Profile (M) łączymy na żądaną długość.

**(FR)** Montage des profils d'accrochage PVC (M) à la structure. Ajoutez les profilés (M) les uns aux autres pour obtenir la longueur souhaitée.

**(GB)** Mounting PVC profiles (M) to the wooden structure. Join profiles (M) to achieve desired length.

**(IT)** Il montaggio di profili in PVC (M) per strutture in legno. Il profili (M) combinare per la lunghezza desiderata.

**(DE)** Montage von PVC-Profilen (M) an der Holzkonstruktion. Verbinden Sie Profile (M), um die gewünschte Länge zu erreichen.

**(NL)** PVC-profielen (M) aan de houten structuur koppelen. Voeg profielen (M) samen om de gewenste lengte te bereiken.

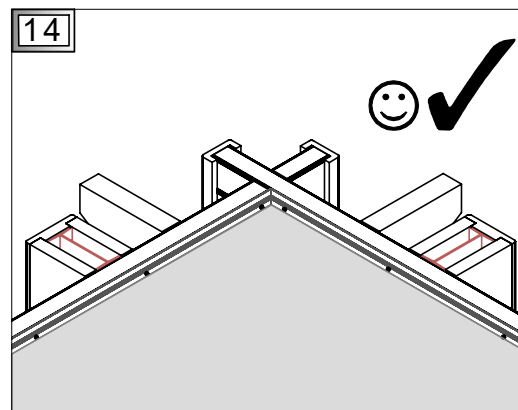
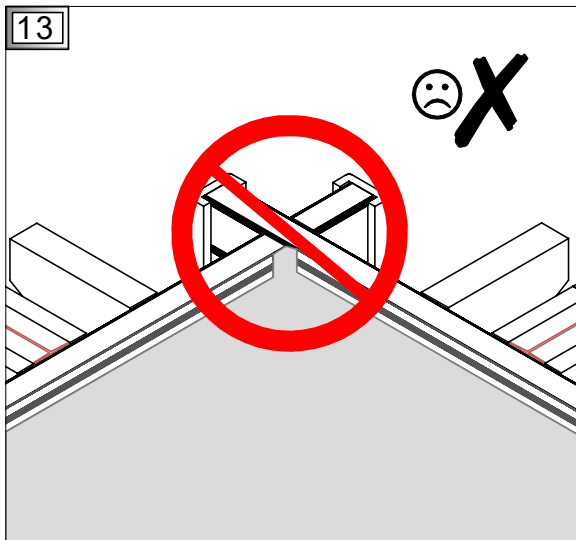
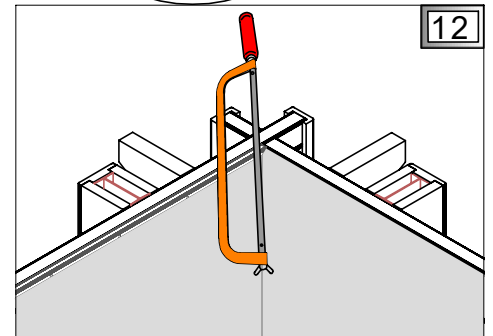
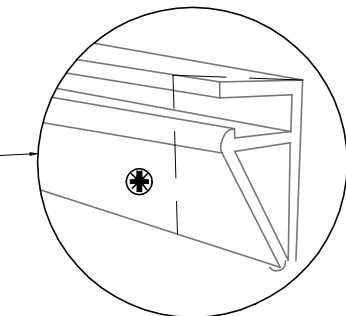
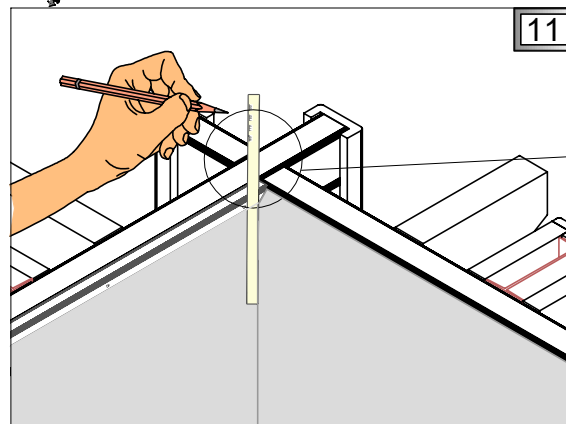
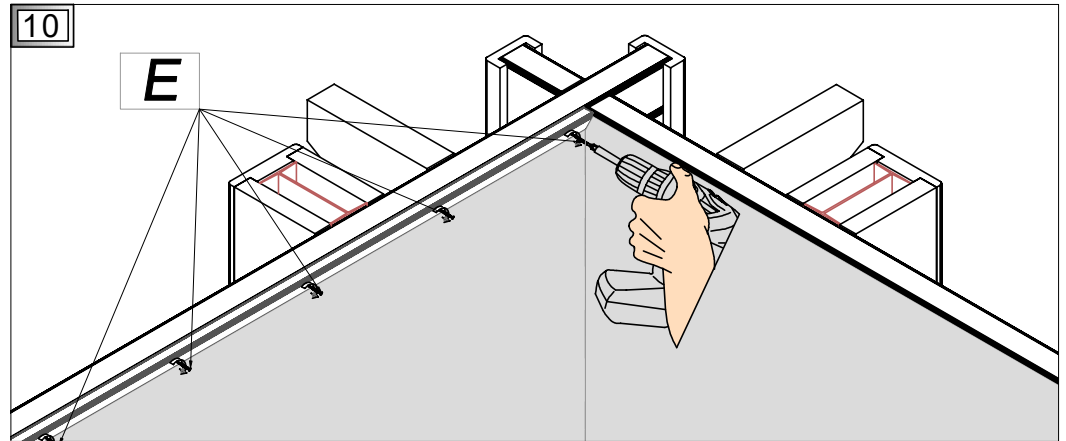
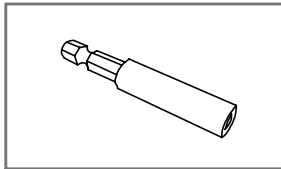
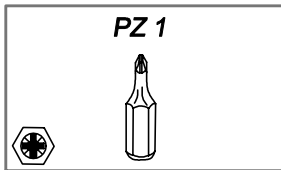
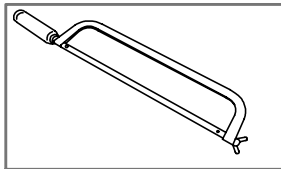
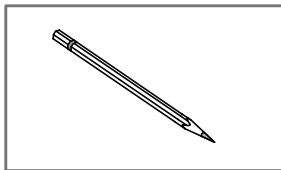
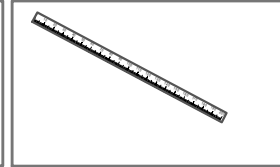
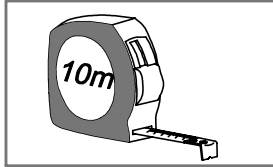
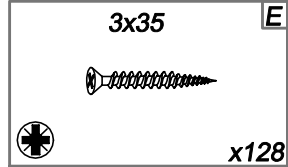
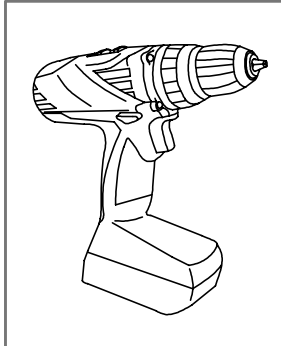

**(PL)** Geowłóknina i Liner

**(GB)** Geotextile and liner

**(DE)** Geotextilien und Futter

**(FR)** Géotextile et liner

**(IT)** Geotessile e liner

**(NL)** Geotextiel en voering



**(PL)** Rozłożenie geowłókniny (O) oraz linera (foli basenowej) (W).

**(FR)** Mise en place du feutre (O) et du liner (W).

**(GB)** Installation of the geotextile (O) and liner (W).

**(IT)** Distribuzione di geotessile (O) e di liner (foglia per piscina) (W).

**(DE)** Installation des Geotextils (O) und von Futter (Einhängfolie) (W).

**(NL)** Installatie van het geotextiel (O) en voering (W).

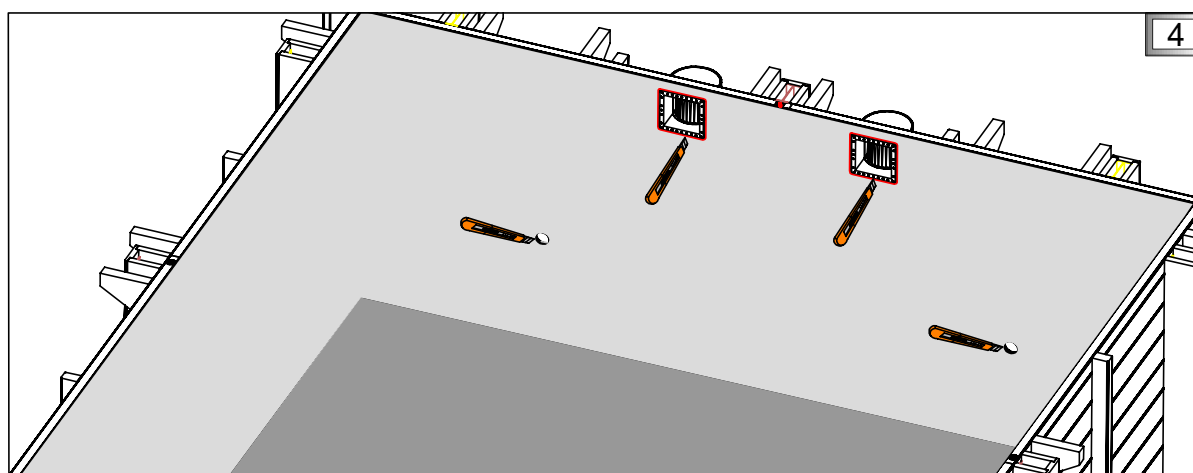
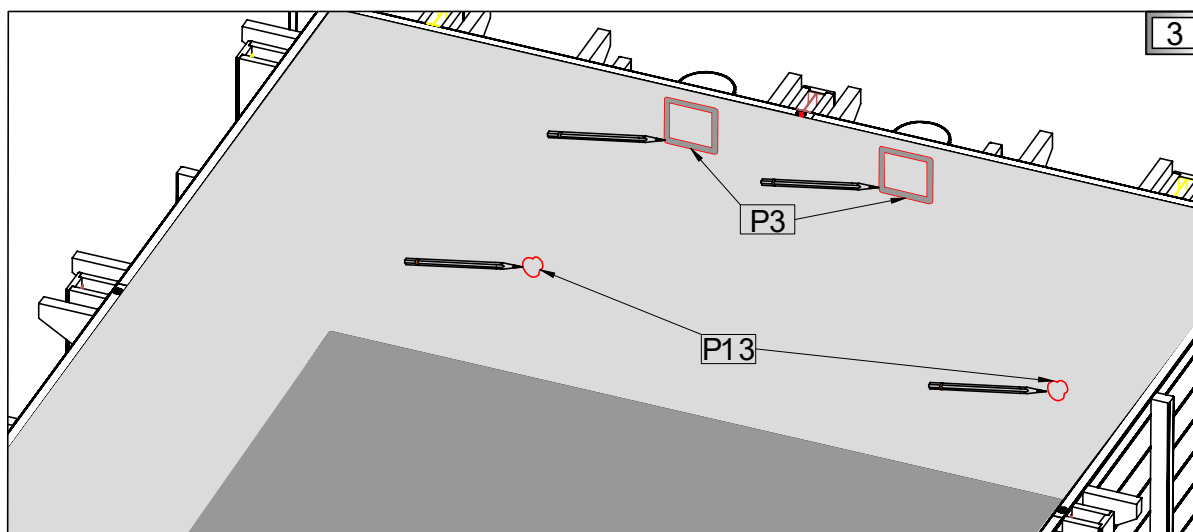
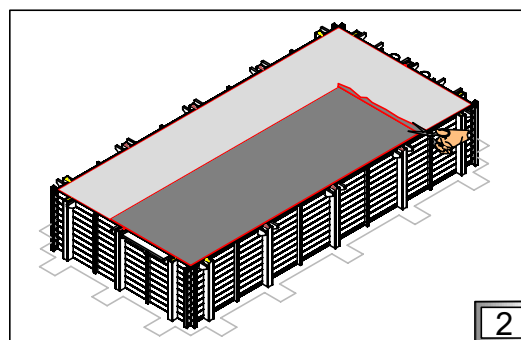
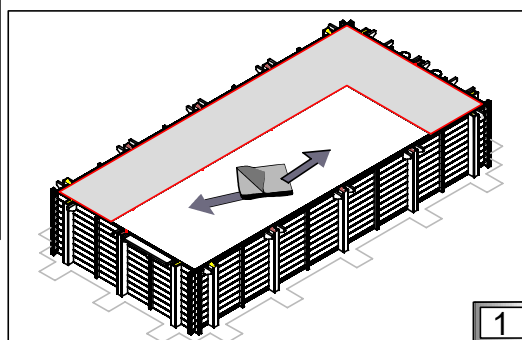
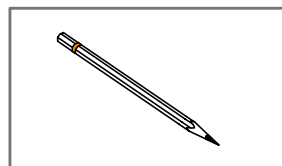
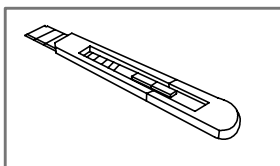
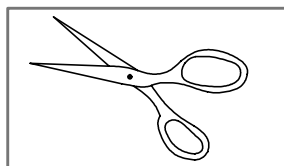
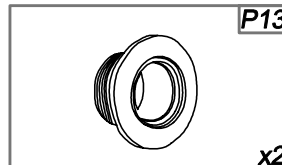
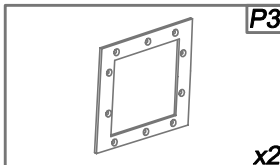
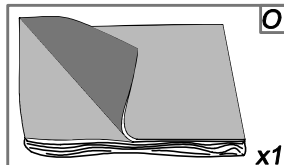
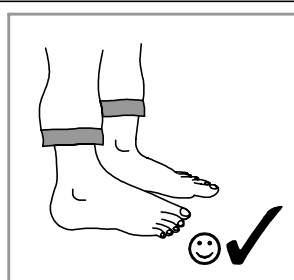



**(PL)** Geotłóknina i liner

**(GB)** Geotextile and liner

**(DE)** Geotextilien und Futter

**(FR)** Géotextile et liner

**(IT)** Geotessile e liner

**(NL)** Geotextiel en voering



**(PL)** Rozłozenie geotłókniny (O) oraz linera (foli basenowej) (W).

**(FR)** Mise en place du feutre (O) et du liner (W).

**(GB)** Installation of the geotextile (O) and liner (W).

**(IT)** Distribuzione di geotessile (O) e di liner (foglia per piscina) (W).

**(DE)** Installation des Geotextils (O) und von Futter (Einhängfolie) (W).

**(NL)** Installatie van het geotextiel (O) en voering (W).

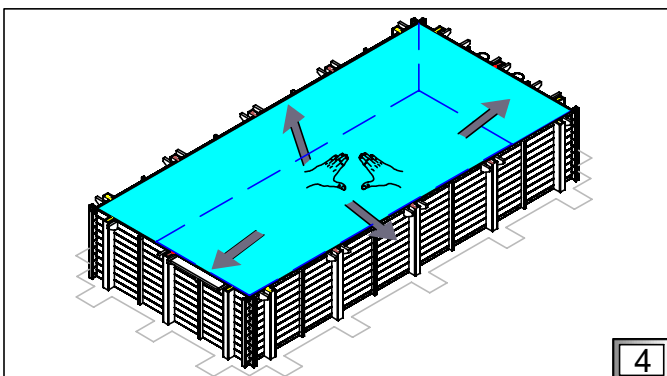
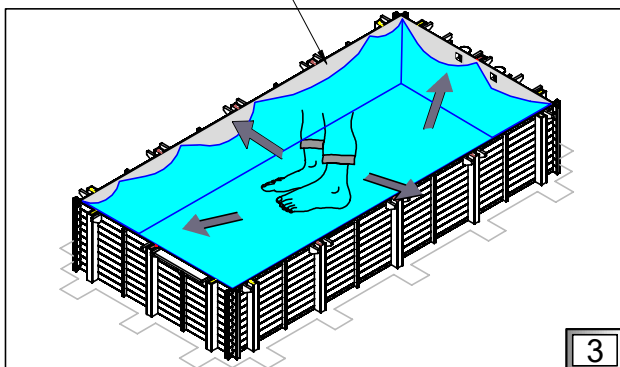
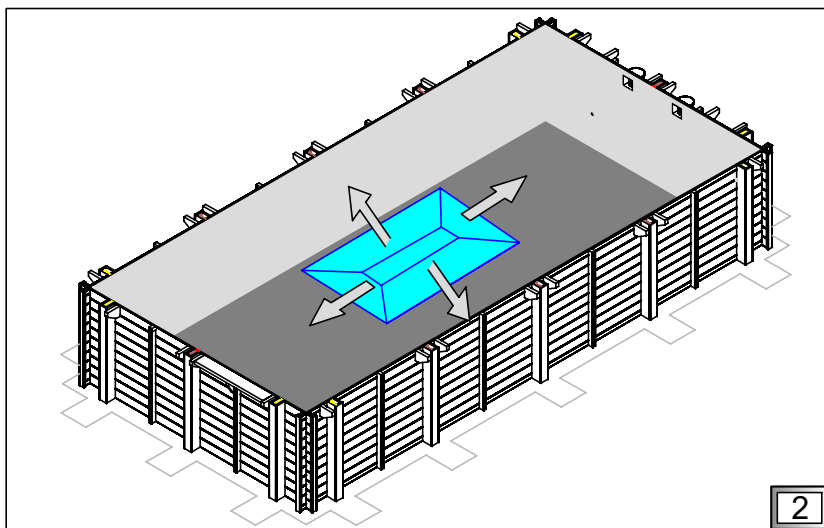
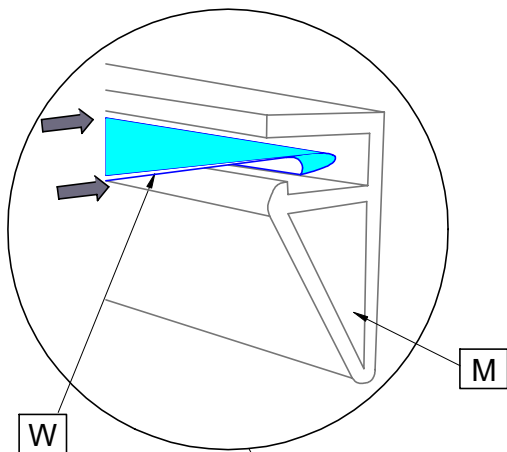
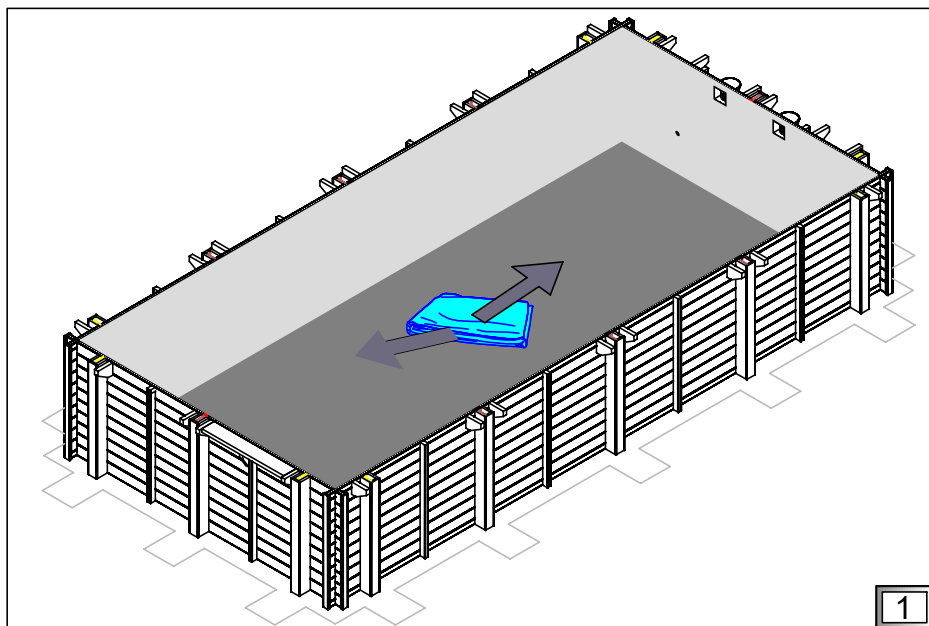
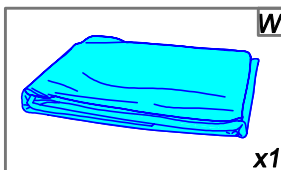
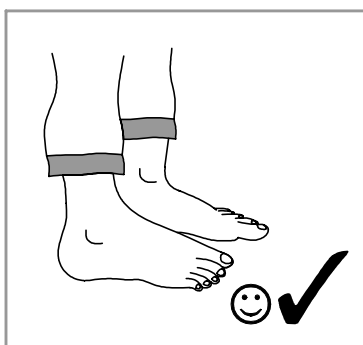

**PL** Liner

**GB** Liner

**DE** Futter

**FR** Liner

**IT** Liner

**NL** Voering



- PL** Montaż linera oraz stopera (N) w profilach PVC (M).
- FR** Le montage du liner et de la bandelette (N) pour les profils d'accrochage (M).
- GB** Mounting the liner and liner lock (N) in PVC profiles (M).
- IT** Il montaggio di liner e tappo (N) in profili in PVC (M).
- DE** Montage des Verschluss des Futters (N) der PVC-Profile (M).
- NL** De voeringvergrendeling (N) in PVC-profielen monteren (M).

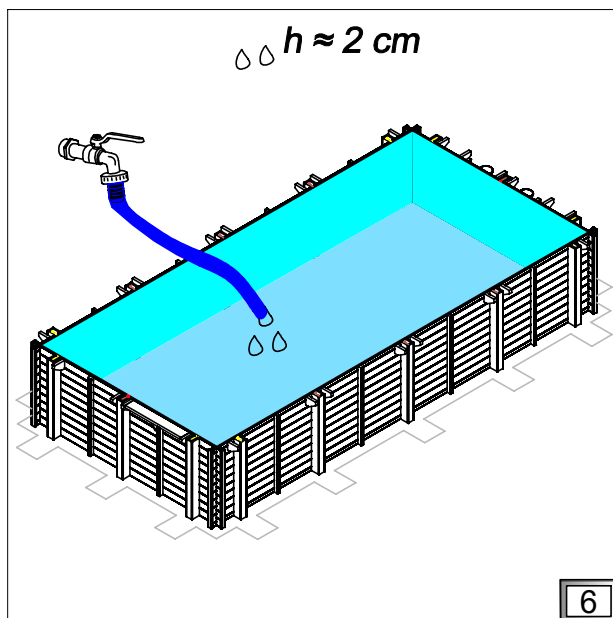
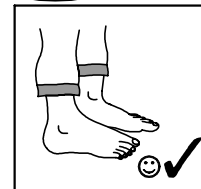
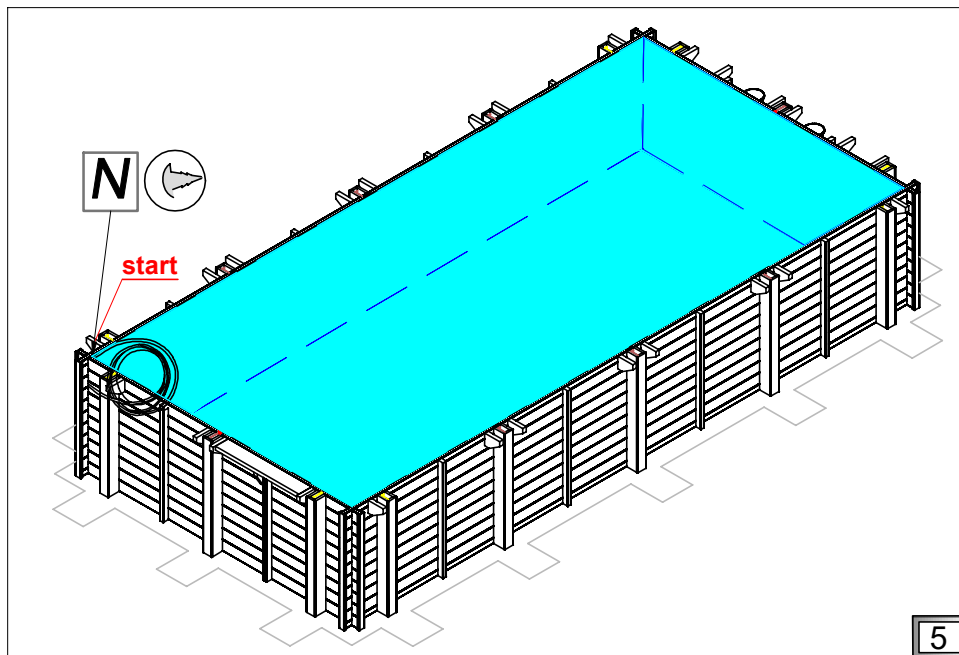
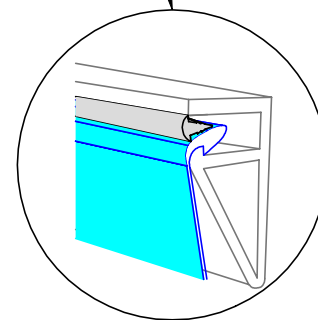
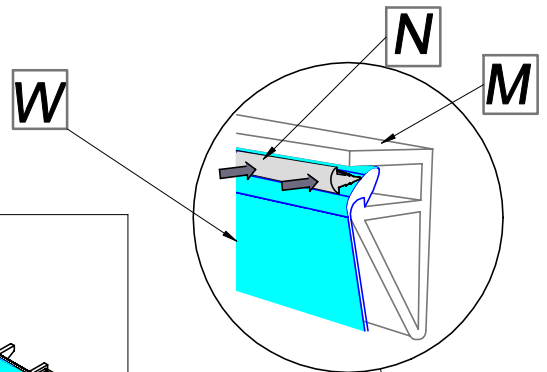
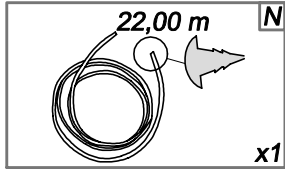
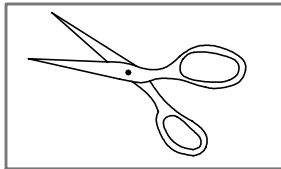

- PL** Wyrównaj sfałdowania po nalaniu wody.
- FR** Etalez les plis après avoir mis de l'eau.
- GB** Smooth all folds after pouring water.
- IT** Allineare le piegature dopo il versamento di acqua.
- DE** Glätten Sie alle Falten nachdem Sie das Wasser eingelassen haben.
- NL** Maak alle vouwen glad na het gieten van water.

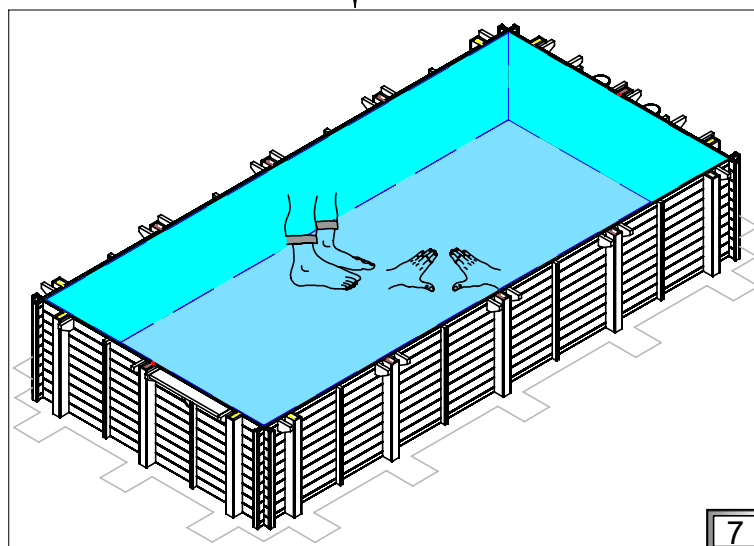

**(PL) Dysze**

**(GB) Nozzles**

**(DE) Düsen**

**(FR) Les buses de refoulement**

**(IT) Ugelli**

**(NL) Jet straal**



**(PL)** Po kolejnym nalaniu wody wyrównać sfaldowania. Wyrnij otwór pod dyszę.

**(FR)** Après le versement de l'eau éliminez les plis. Faites les trous pour la buse de refoulement.

**(GB)** After pouring the water smooth all folds. Cut the hole for the nozzle.

**(IT)** Dopo un altro riempimento di acqua livellare le pieghe. Ritagliare i fori fino all'ugello.

**(DE)** Nachdem Sie das Wasser eingelassen haben, glätten Sie alle Falten. Schneiden Sie das Loch für die Düse heraus.

**(NL)** Strijk na het vullen van het water alle vouwen soepel. Snijd het gat voor de straalpijp.

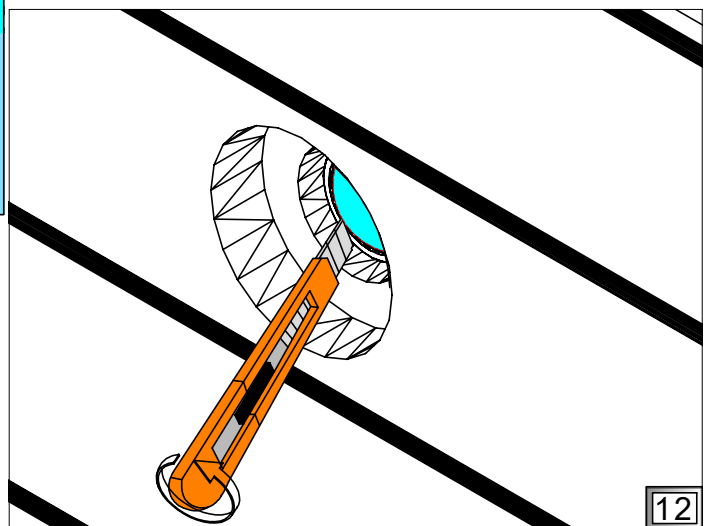
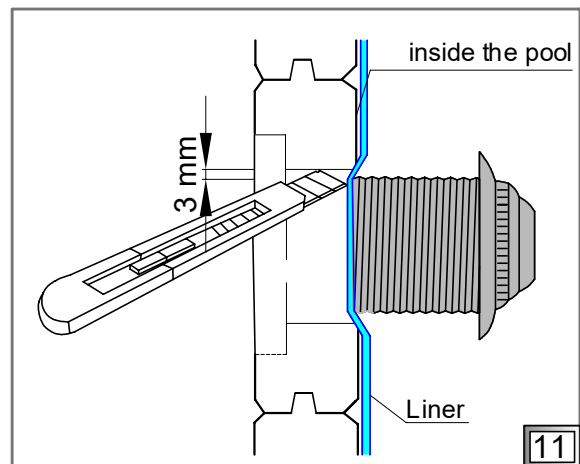
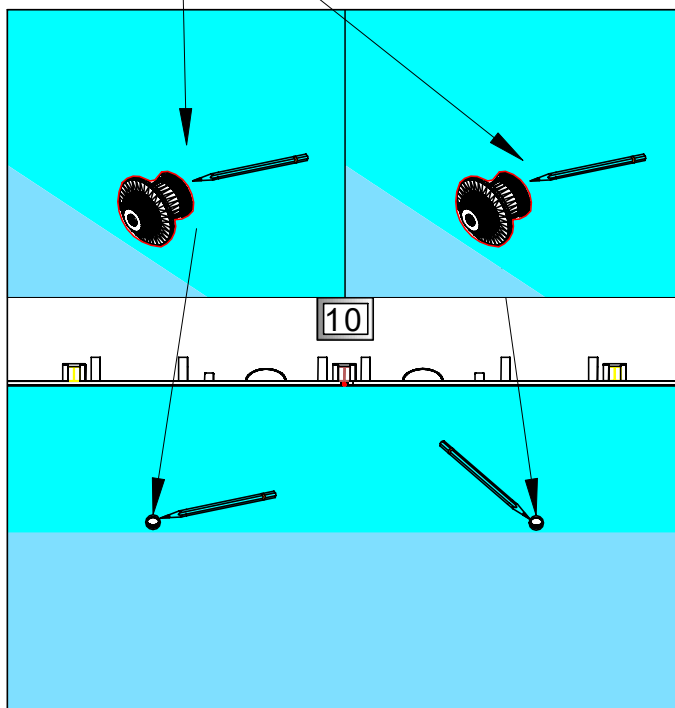
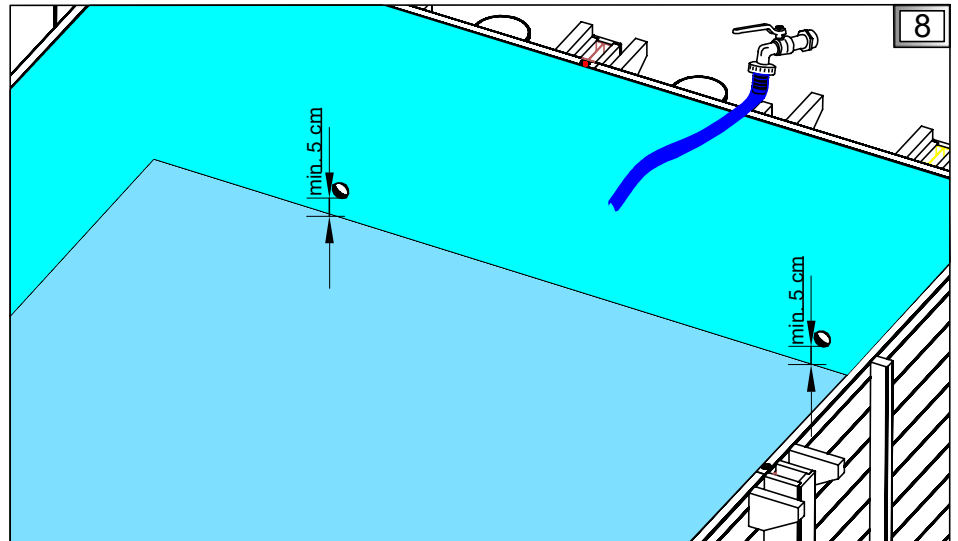
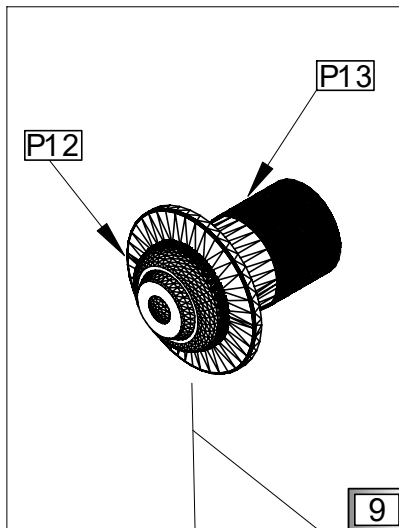
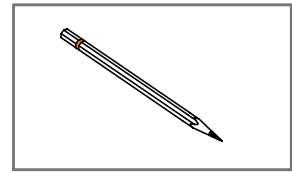
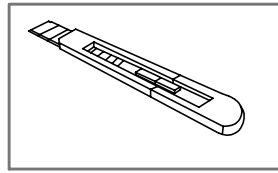
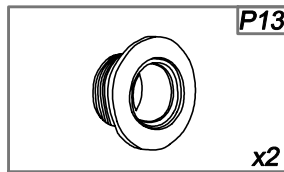
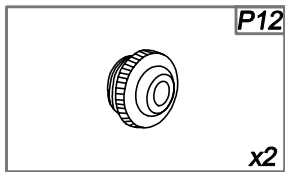

**PL** Dysze

**GB** Nozzles

**DE** Düsen

**FR** Les buses de refoulement

**IT** Ugelli

**NL** Jet straal



**PL** Uszczelki (P11) posmarować wazeliną od strony linera. Mocowanie dysz.

**FR** Etalez de la vaseline sur les joints (P11) du côté du liner. Le montage de la buse de refoulement.

**GB** Smear liner facing side of the gasket (P11) with vaseline. Installation of nozzles.

**IT** Sui sigilli (P11) da parte di liner mettere la vaselina. Fissaggio dei ugelli.

**DE** Beschmieren Sie die dem Futter (P11) zugewandte Seite der Dichtung mit Vaseline. Installation der Düsen.

**NL** Smeer de naar de voering (P11) gerichte kant van de pakking in met vaseline. Installatie van de jet straal.

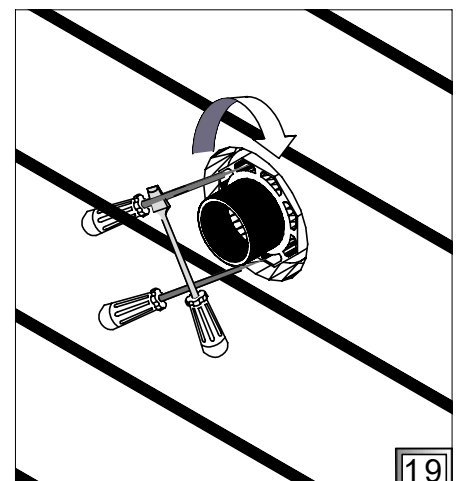
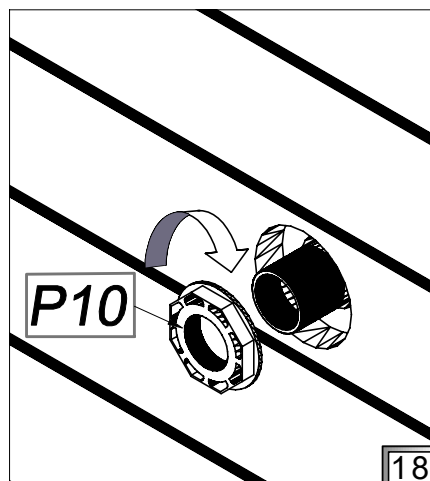
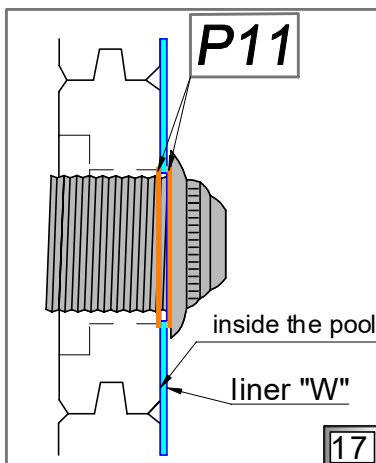
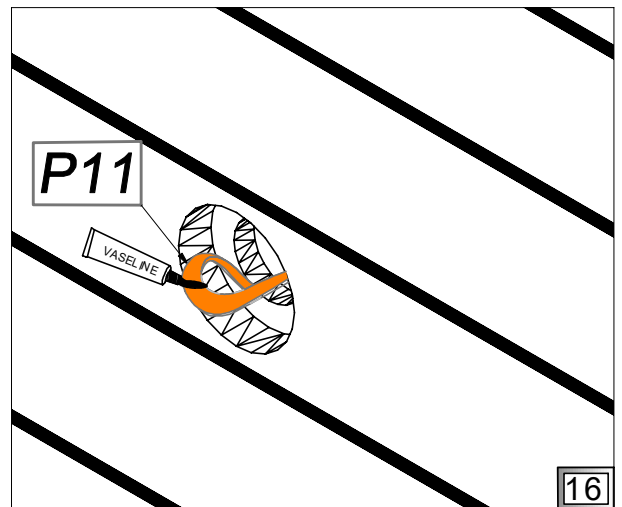
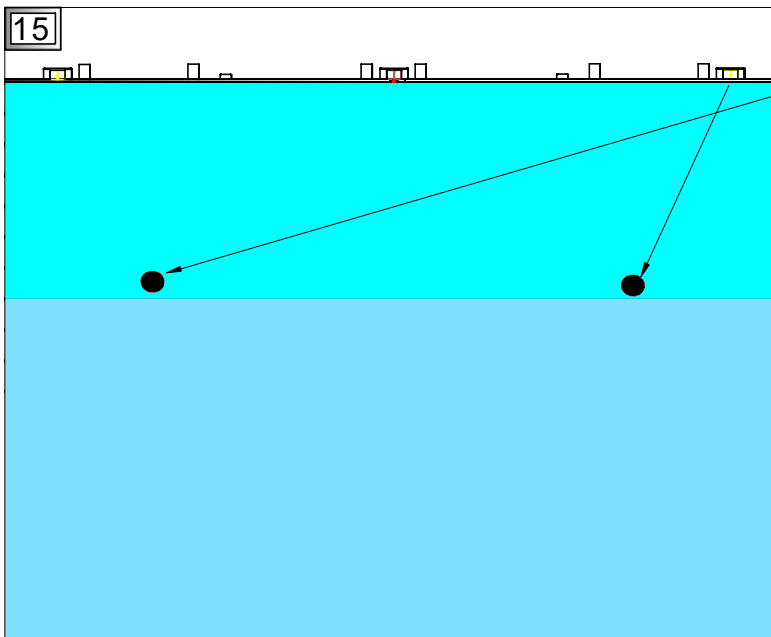
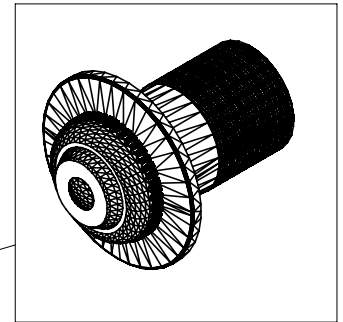
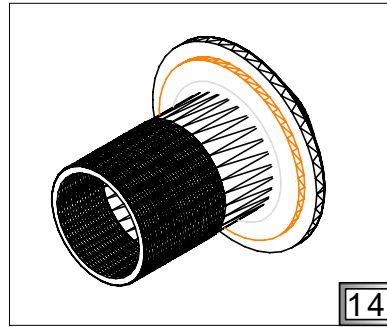
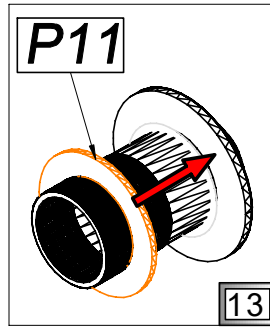
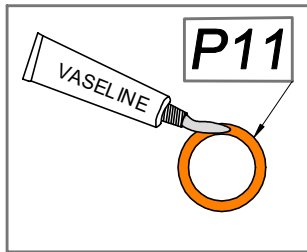
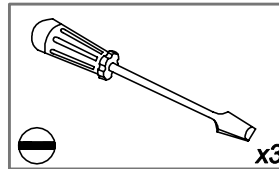
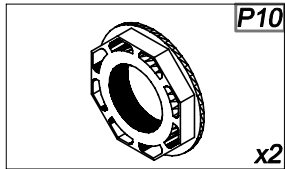
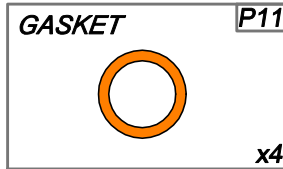

**PL** Dysze

**GB** Nozzles

**DE** Düsen

**FR** Les buses de refoulement

**IT** Ugelli

**NL** Jet straal



**PL** Pokryj gwint dysz taśmą teflonową.

**FR** Mettez le ruban teflon sur la partie filetée de la buse.

**GB** Cover thread of hose connector with teflon tape.

**IT** Ricoprire il filetto degli ugelli con il nastro di teflon.

**DE** Decken Sie das Gewinde des Schlauchanschlusses mit Teflonband ab.

**NL** Dek de kabel van de slangconnector af met teflon-tape.

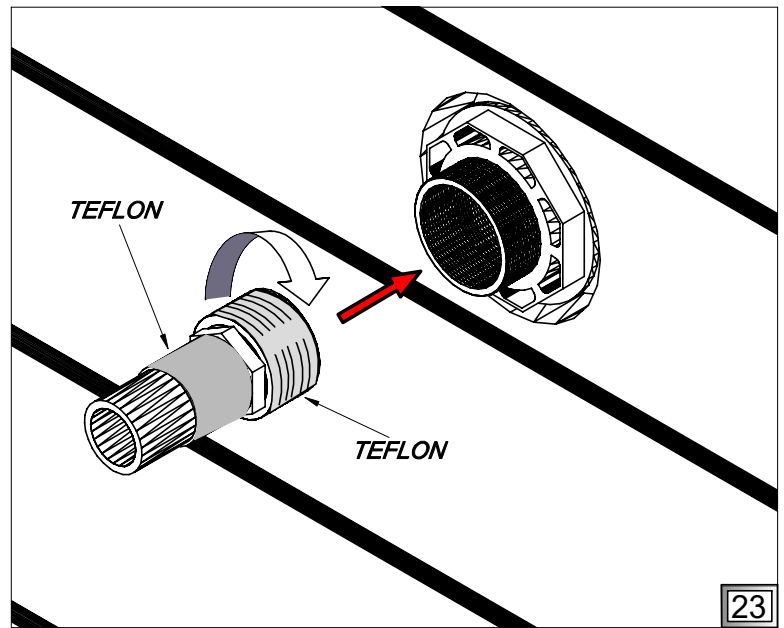
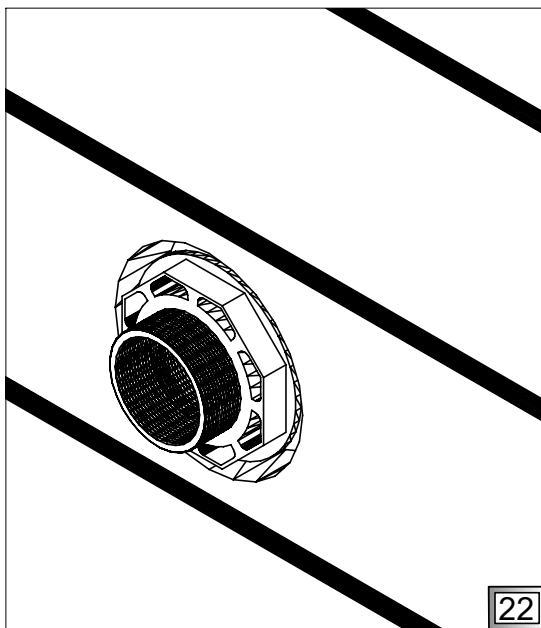
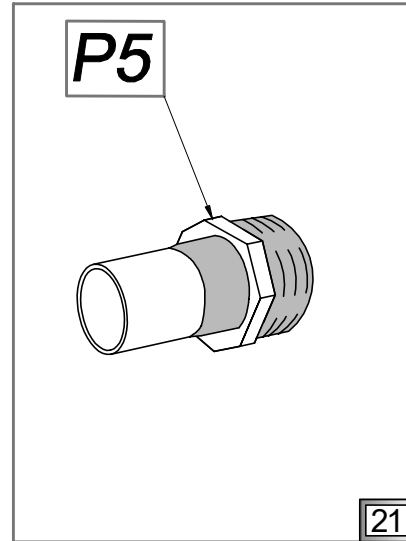
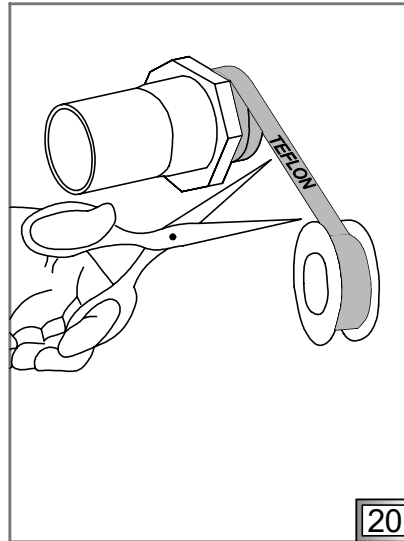
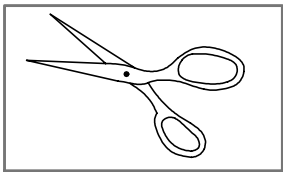
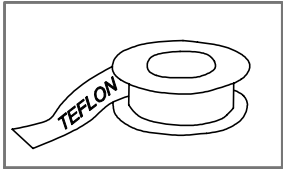
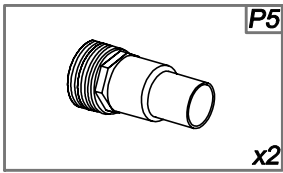

**(PL)** Napełnianie wodą

**(GB)** Filling with water

**(DE)** Wasser einlassen

**(FR)** Le versement de l'eau

**(IT)** Riempimento con acqua

**(NL)** Vullen met water



**(PL)** Kontynuuj napełnianie wodą. Wytnij otwór w miejscu skimmera (P0).

**(FR)** Continuez à mettre de l'eau. Coupez un trou pour le skimmer (P0).

**(GB)** Keep pouring water. Cut a hole in the place of skimmer (P0).

**(IT)** Continuare a riempire con acqua. Tagliare il foro nel posto dello skimmer (P0).

**(DE)** Lassen Sie weiterhin Wasser einlaufen. Schneiden Sie ein Loch an der Stelle des Skimmers (P0).

**(NL)** Blijf water vullen. Snijd een gat in de plaats van de skimmer (P0).

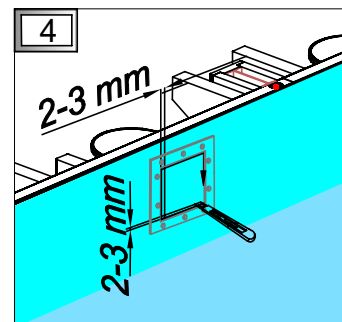
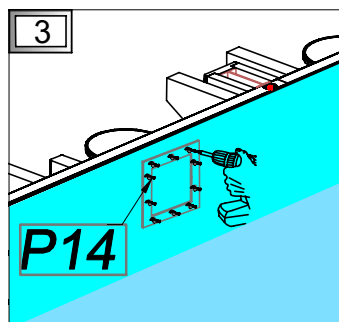
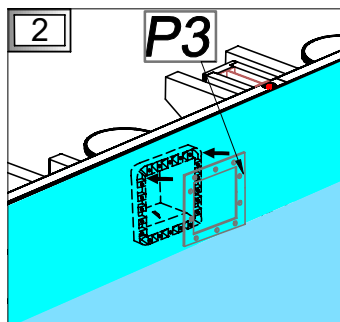
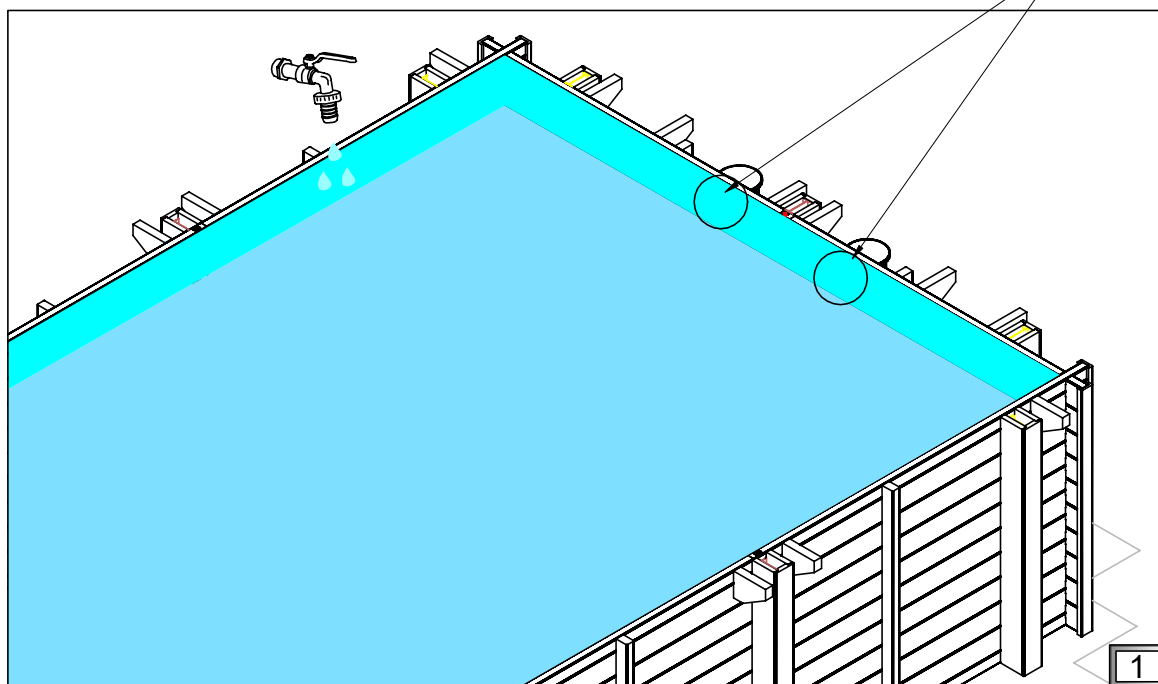
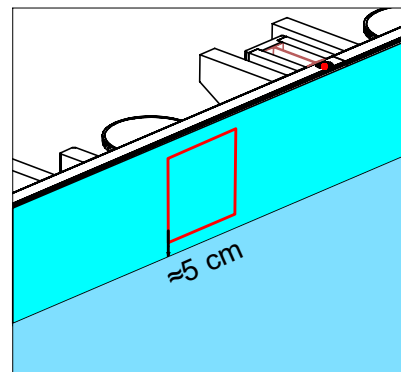
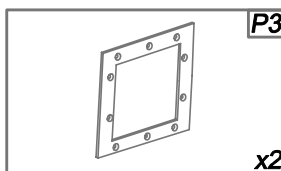
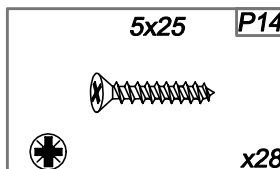
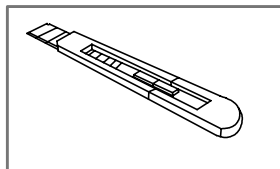
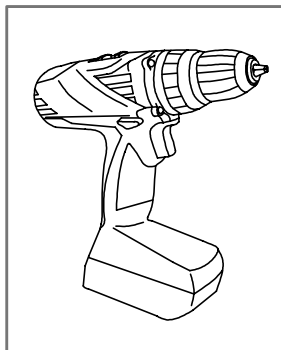
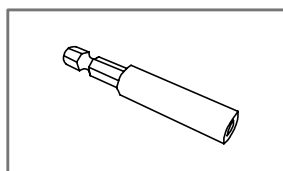
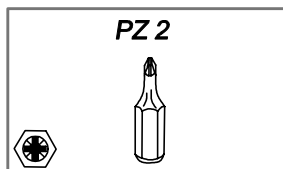
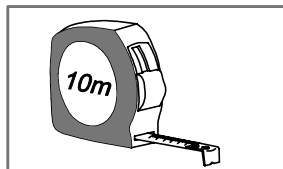

**(PL)** Napelnianie wodą

**(GB)** Filling with water

**(DE)** Wasser einlassen

**(FR)** Le versement de l'eau

**(IT)** Riempimento con acqua

**(NL)** Vullen met water



**(PL)** Usuń ramkę (P3). Zamocuj uszczelkę (P4), ramkę (P3), maskownicę (P2).

**(FR)** Enlevez le cadre (P3). Fixez le joint (P4), le cadre (P3), le cache (P2).

**(GB)** Remove a frame (P3). Install gasket (P4), frame (P3), skimmer frame (P2).

**(IT)** Rimuovere la cornice (P3). Montare la guarnizione (P4), la cornice (P3), mascherino (P2).

**(DE)** Entfernen Sie einen Rahmen (P3). Installieren Sie Dichtung (P4), Rahmen (P3), Abdeckrahmen (P2).

**(NL)** Verwijder een kader (P3). Installeer pakking (P4), frame (P3), skimmer frame (P2).

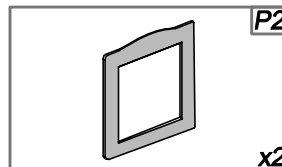
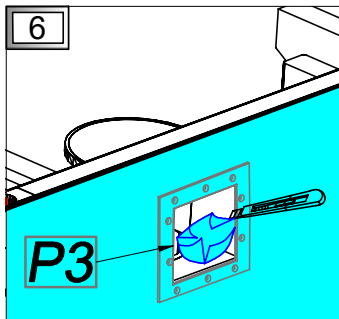
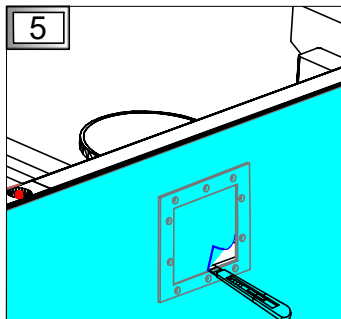

P2

x2

GASKET

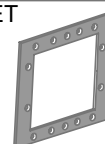

P4

x4

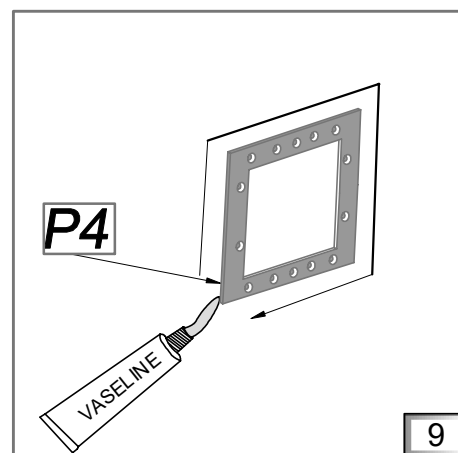
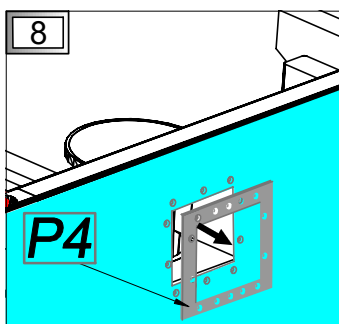
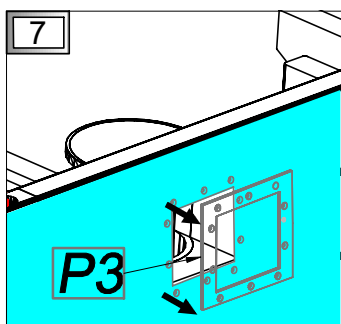

9

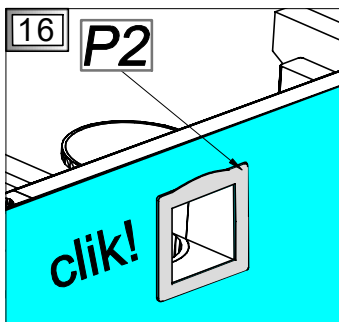
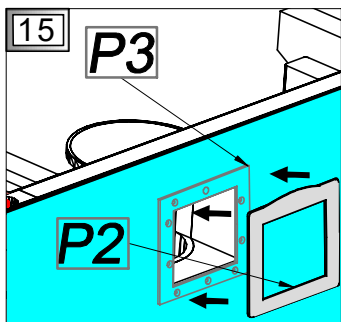
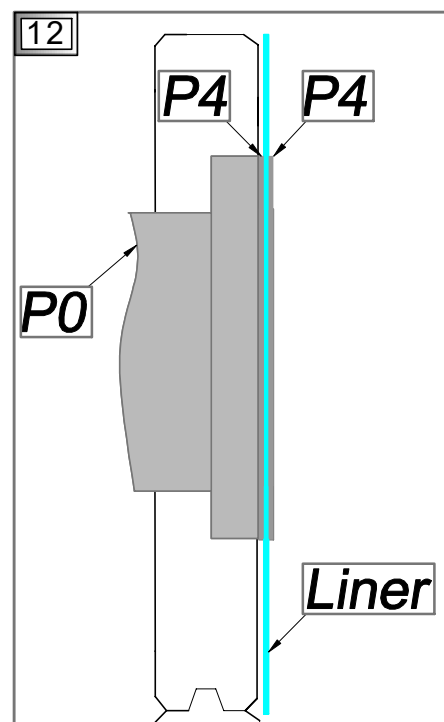
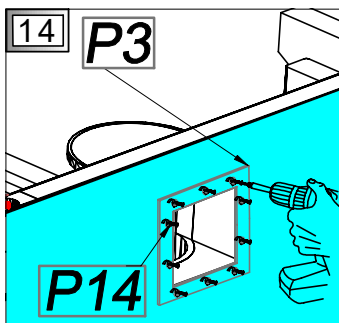
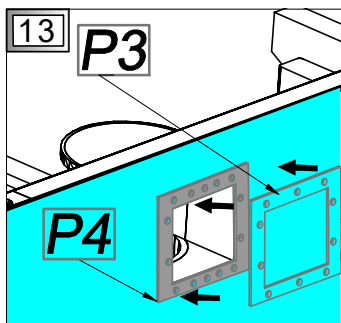
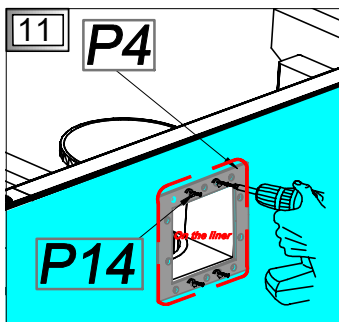
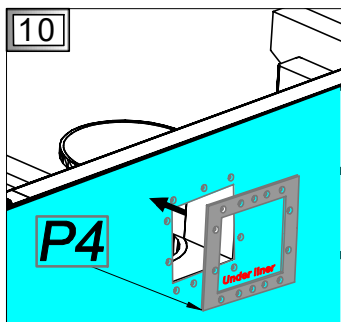

klik!

**(PL)** *Napełnianie wodą*

**(GB)** *Filling with water*

**(DE)** *Wasser einlassen*

**(FR)** *Le versement de l'eau*

**(IT)** *Riempimento con acqua*

**(NL)** *Vullen met water*



- (PL)** Napełnij wodą do połowy wysokości maskownicy.
- (FR)** Remplissez d'eau jusqu'à mi-hauteur du cadre skimmer.
- (GB)** Fill with water to the middle of the skimmer frame.
- (IT)** Riempire con acqua a metà dell'altezza del mascherino.
- (DE)** Füllen Sie Wasser bis zur Mitte des Abdeckelements.
- (NL)** Vul het water tot het midden van het skimmer frame.

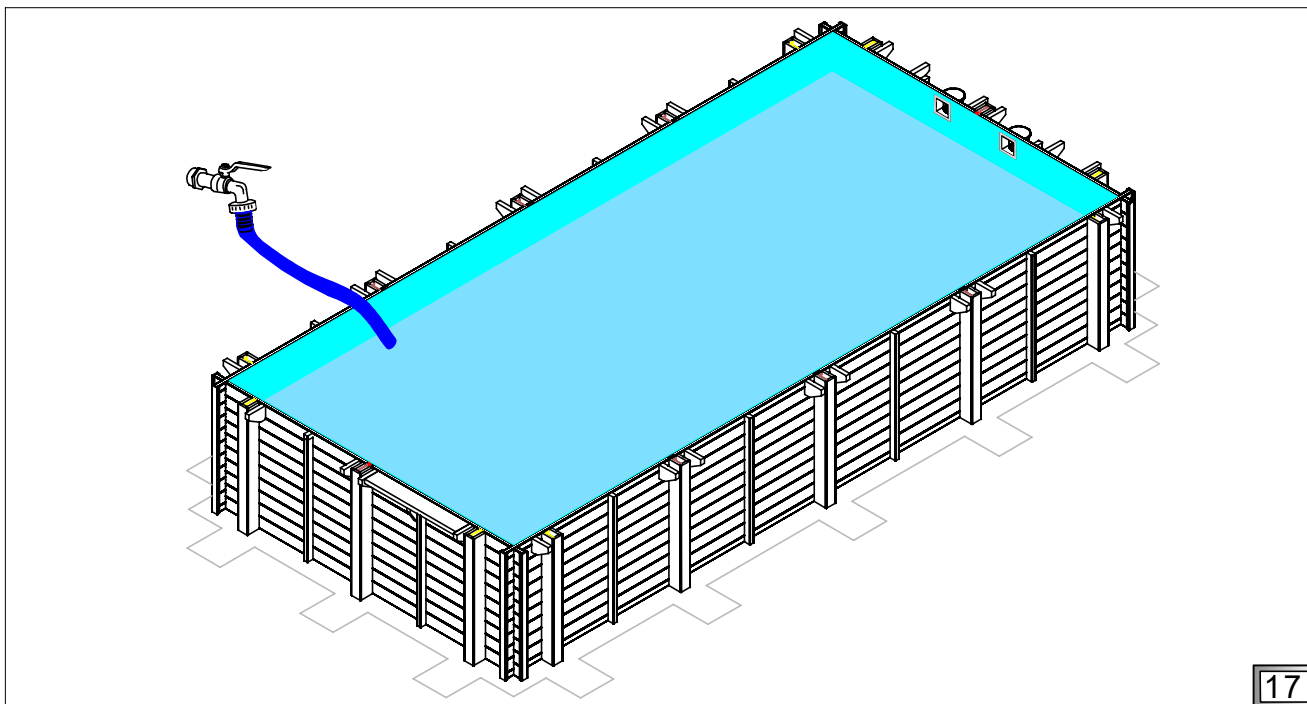

17

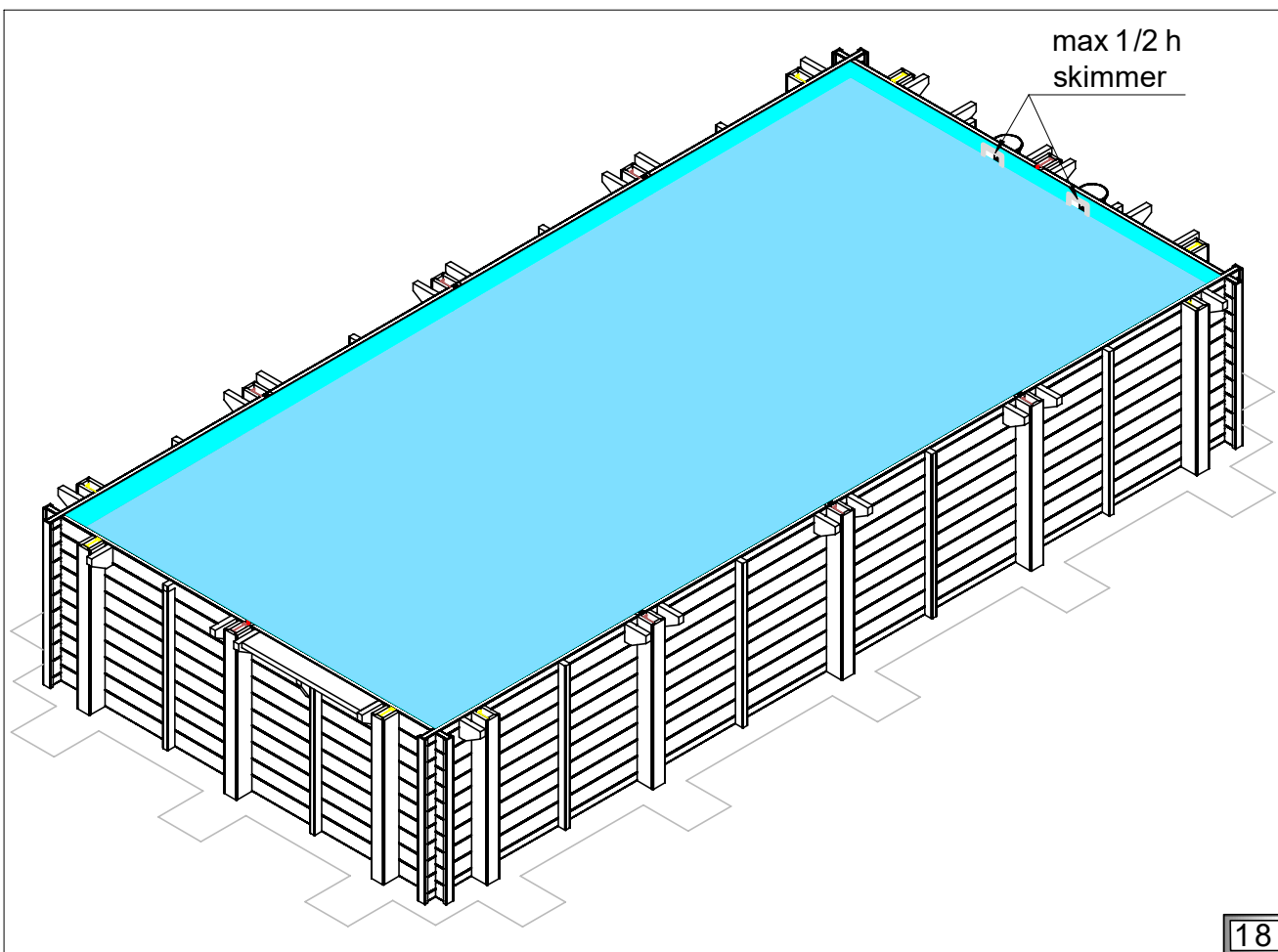

18



**PL Taras**

**GB Terrace**

**DE Terrasse**

**FR Les margelles**

**IT Terrazza**

**NL Terras**



- PL** Montaż desek tarasowych.
- FR** Montage des margelles.
- GB** Installation of terrace boards.
- IT** Installazione delle tavole da terrazza.
- DE** Installation der Terrassendielen.
- NL** Installatie van terrasplanken.

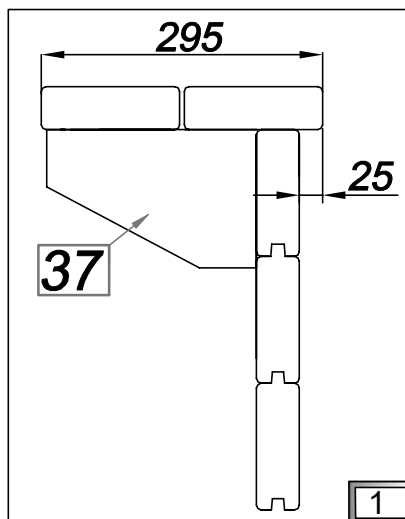
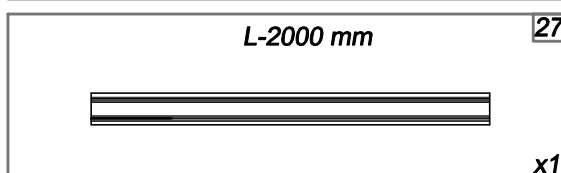
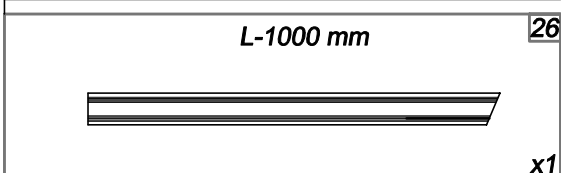
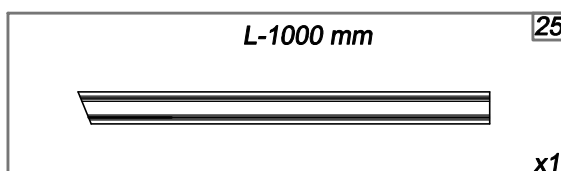
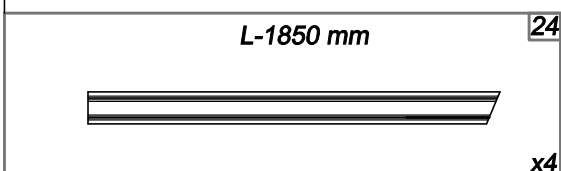
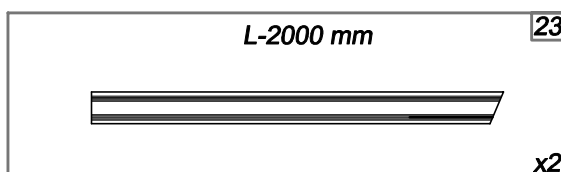
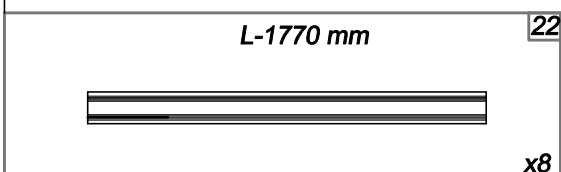
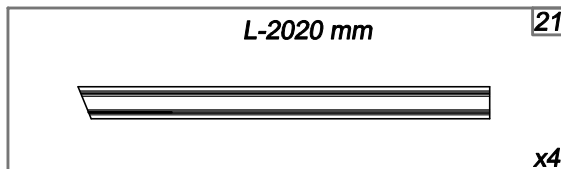
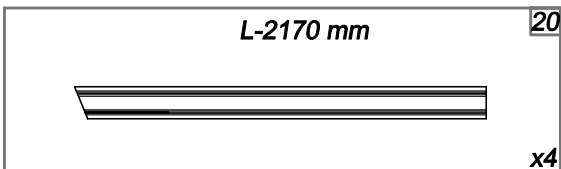
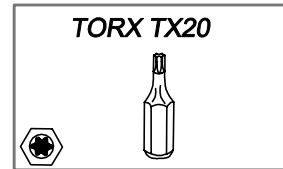
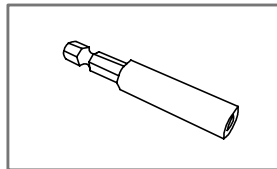
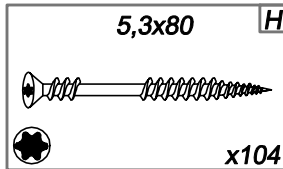
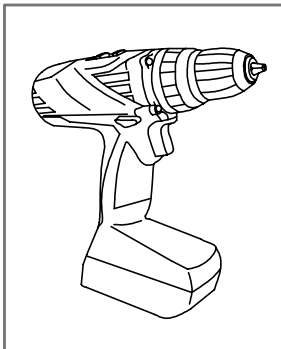

**(PL) Taras**

**(GB) Terrace**

**(DE) Terrasse**

**(FR) Les margelles**

**(IT) Terrazza**

**(NL) Terras**



**(PL)** Zamocuj deski tarsowe według rysunku 2

**(FR)** Monter les margelles suivant le dessin 2.

**(GB)** Mount terrace boards according to the drawing 2.

**(IT)** Montare le tavole da terrazza secondo il disegno 2.

**(DE)** Montieren Sie die Terrassendielen gemäß der Zeichnung 2.

**(NL)** Monteer de terrasplanken volgens de tekening 2.

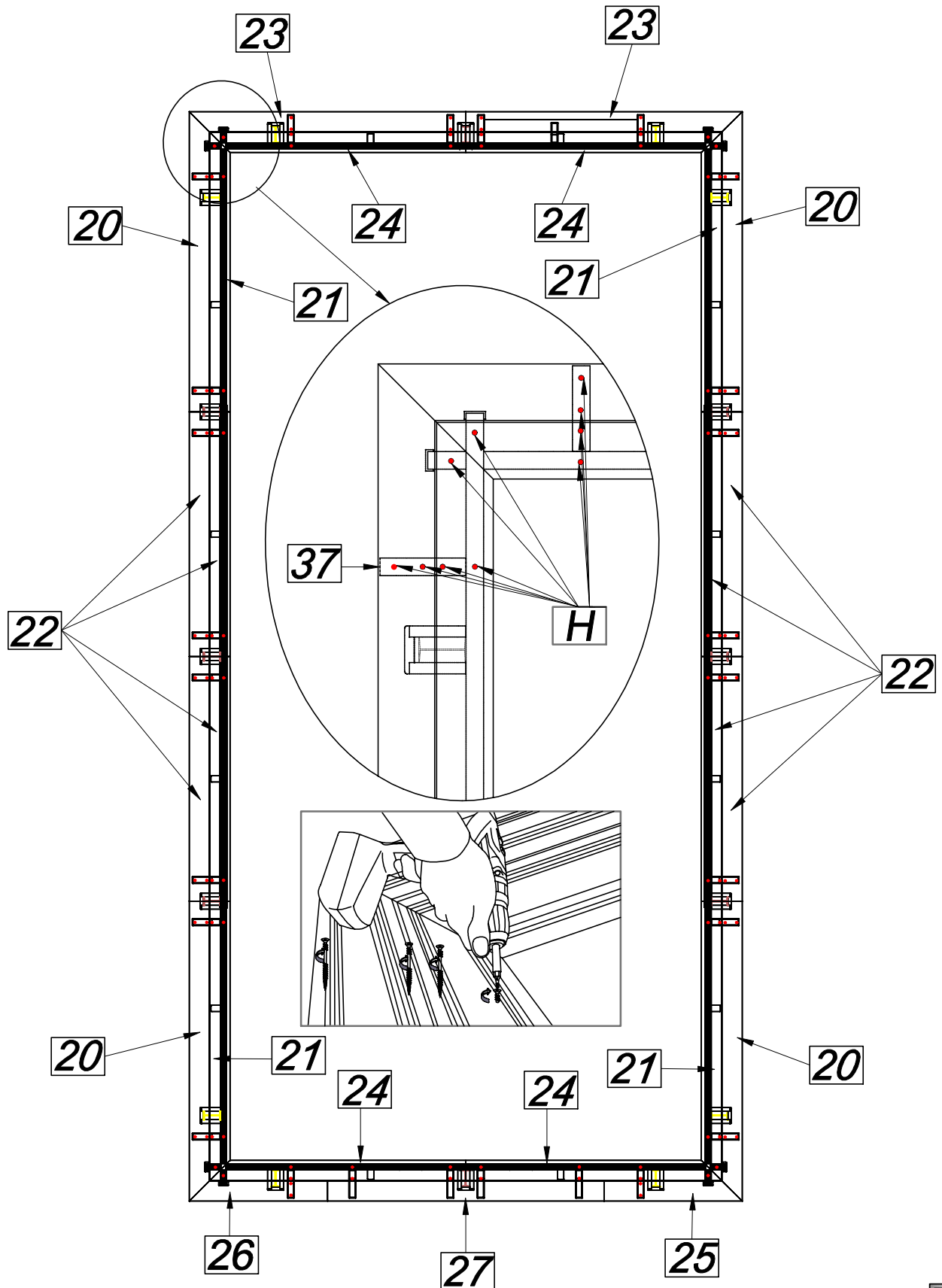

**PL** Zapięcie tarasu

**GB** Clip and hook

**DE** Clip und Haken

**FR** Agraffes de margelles

**IT** Chiusura di terrazza

**NL** Clip en haak



- PL** Montaż zapięcia tarasu (A1, A2).
- FR** Montage du clip et crochet de fixation des margelles (A1, A2).
- GB** Mounting clip and hook (A1, A2).
- IT** Montaggio della chiusura di terrazza (A1, A2).
- DE** Montieren Sie den Clip und den Haken (A1, A2).
- NL** Bevestigings - clip en haak (A1, A2).

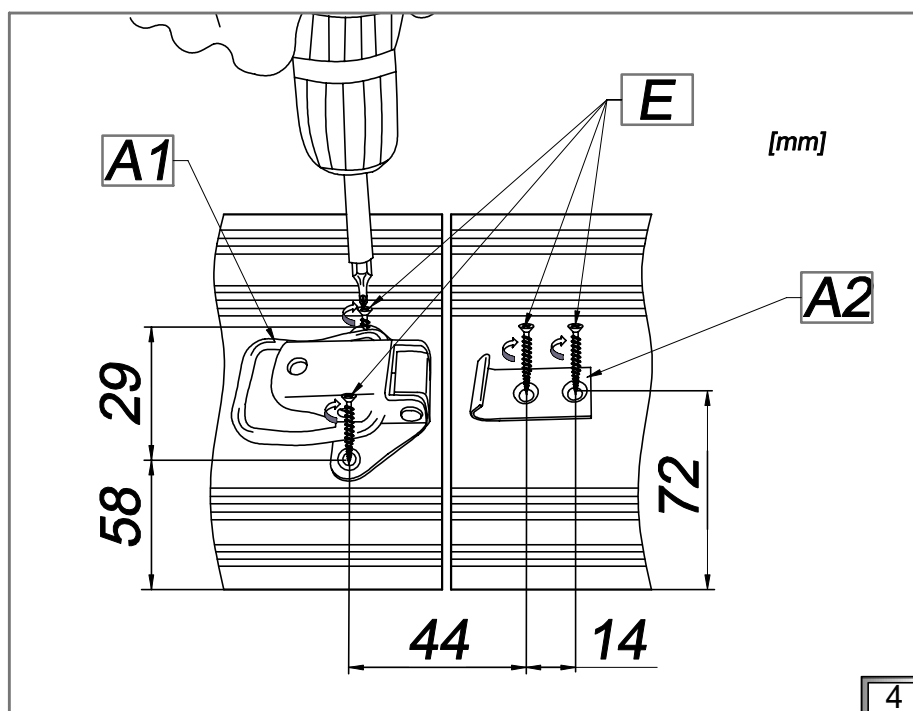
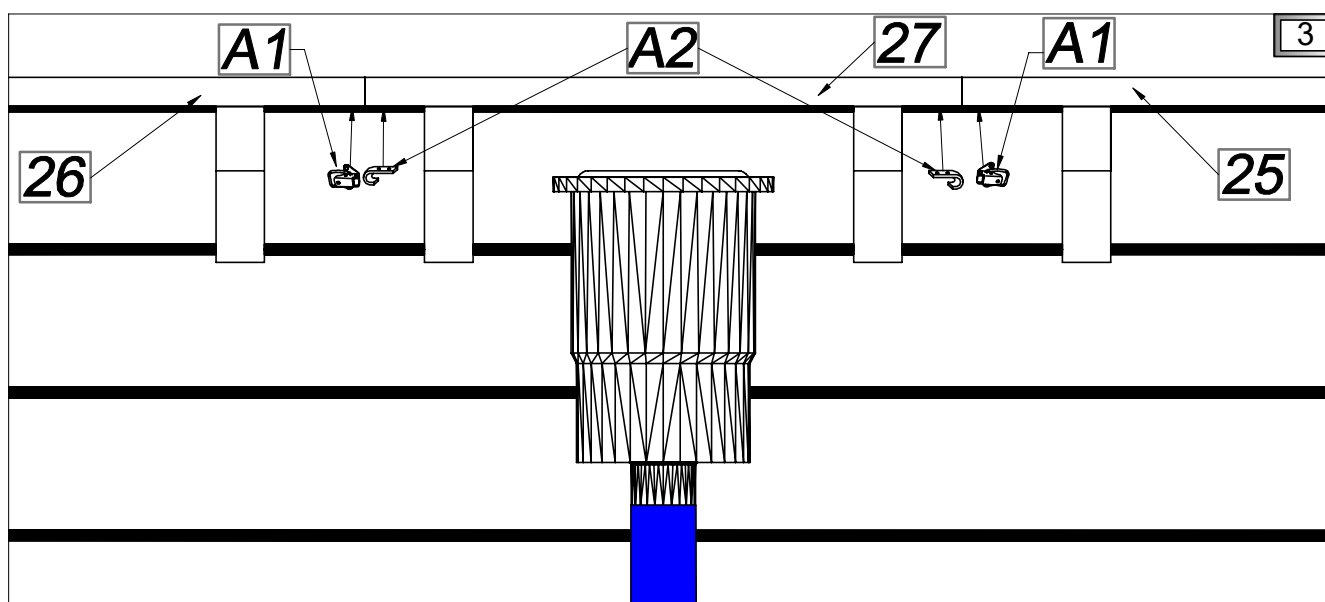
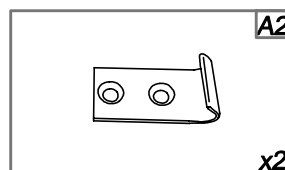
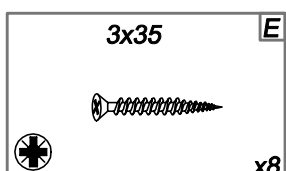
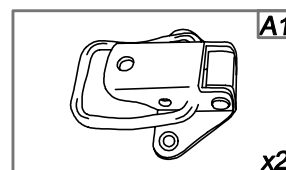
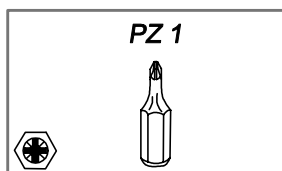
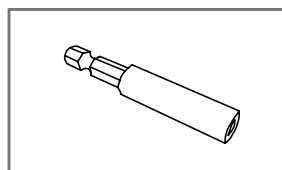
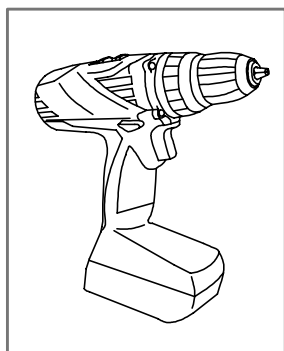

**(PL)** Struktura drewniana

**(GB)** Wooden structure

**(DE)** Holzstruktur

**(FR)** La structure bois

**(IT)** Struttura in legno

**(NL)** Houten structuur



**(PL)** Montaż łącznika karo (38) od spodu desek tarasowych.

**(FR)** Montage des jonctions (38) en dessous des margelles.

**(GB)** Installation of wooden connector (38) to the bottom of terrace boards.

**(IT)** Montaggio di raccordo (38) dal fondo delle tavole da terrazza.

**(DE)** Installation der hölzernen Verbindung (38) an die Unterseite der Terrassendielen.

**(NL)** Installatie van houten connector (38) aan de onderkant van terrasplanken.

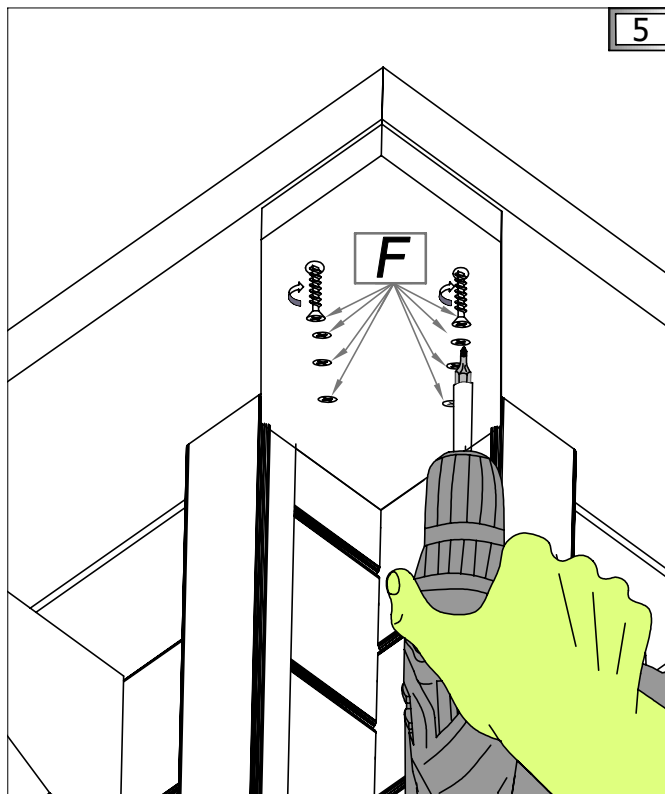
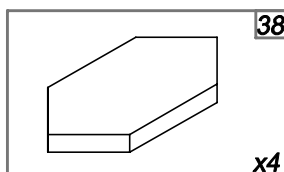
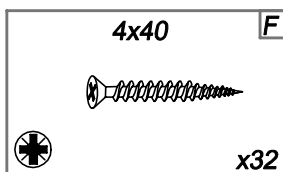
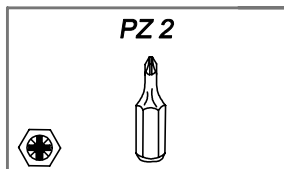
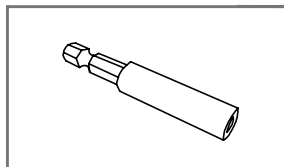
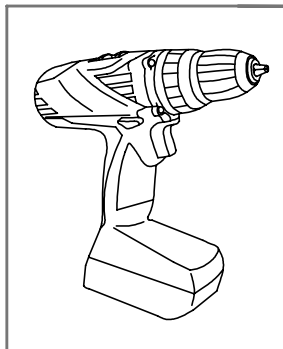

**(PL)** Widok od spodu tarasu.

**(FR)** Vue du dessous des margelles.

**(GB)** View from the bottom of terrace.

**(IT)** Vista in fondo della terrazza.

**(DE)** Blick von der Unterseite der Terrasse.

**(NL)** Aanzicht vanaf de onderkant van het terras.

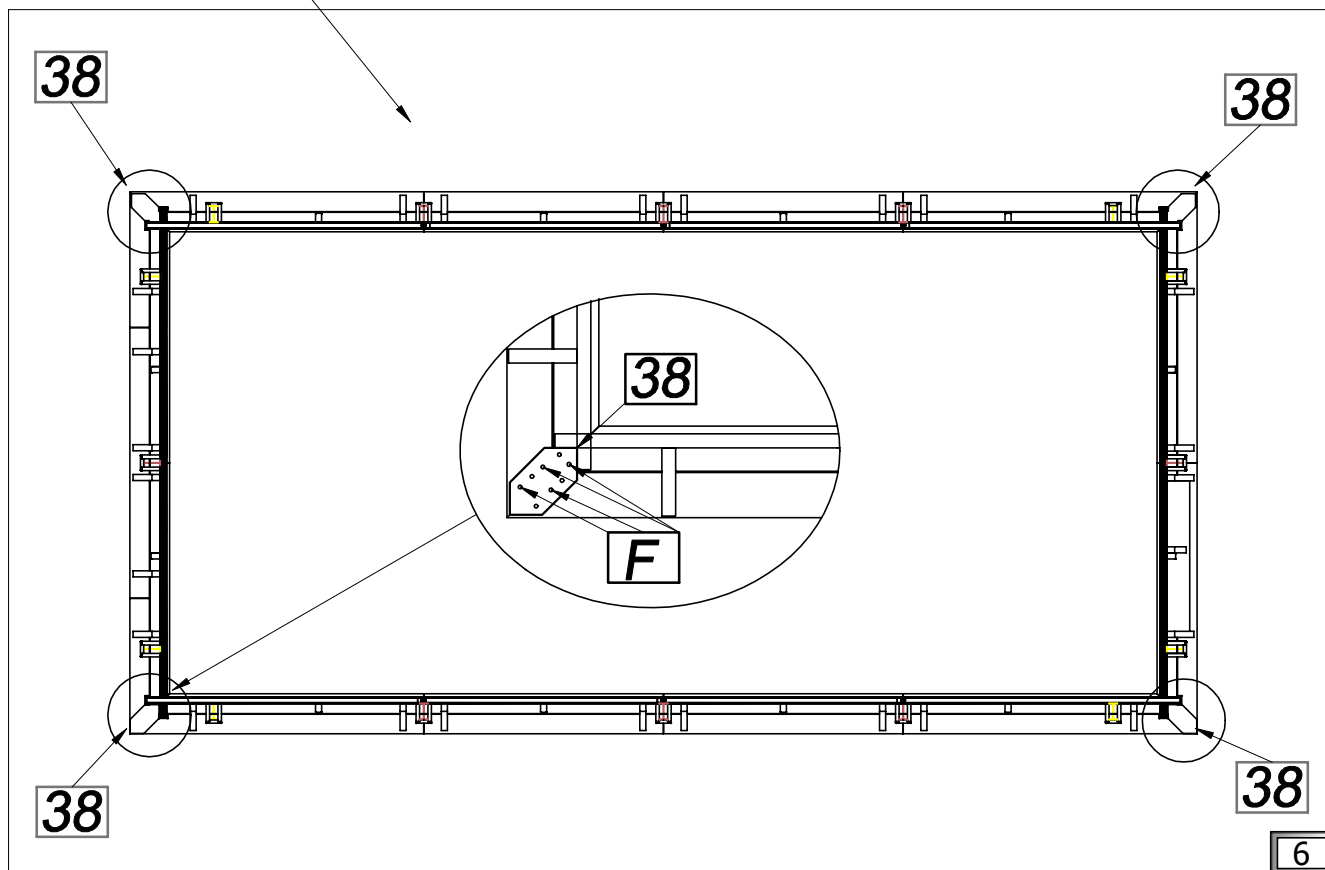

**(PL)** Schody drewniane

**(GB)** Wooden stairs

**(DE)** Hölzeme Treppen

**(FR)** L'escalier bois

**(IT)** Scale di legno

**(NL)** Houten trap



- (PL)** Montaż schodów.
- (FR)** Montage de l'escalier.
- (GB)** Installation of stairs.
- (IT)** Montaggio delle scale.
- (DE)** Installation der Treppen.
- (NL)** Installatie van de trap.

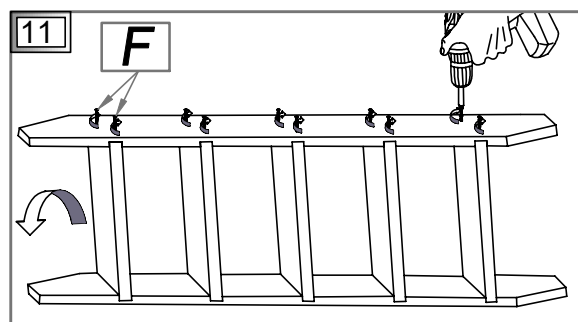
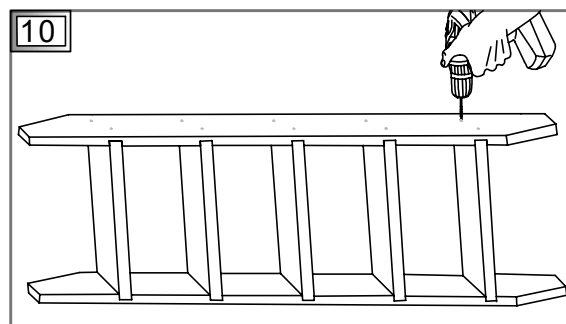
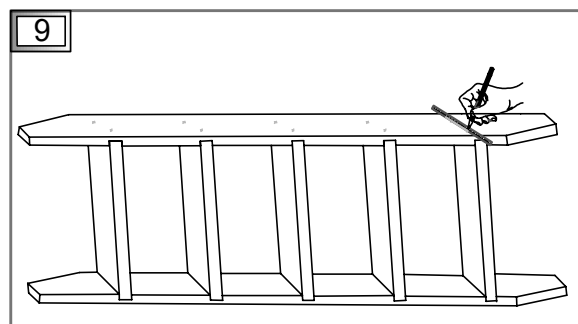
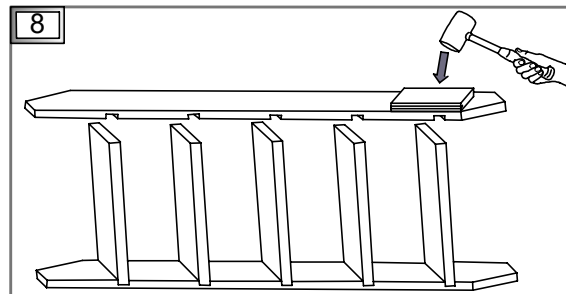
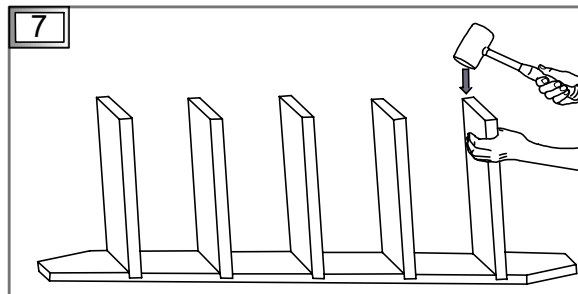
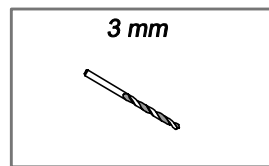
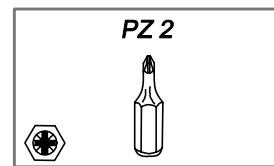
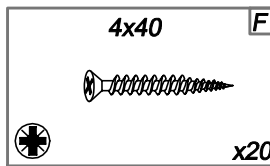
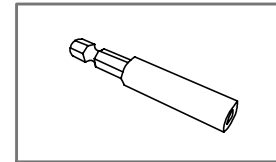
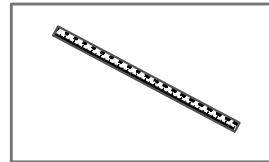
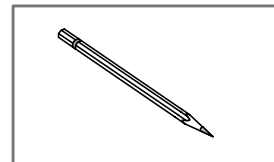
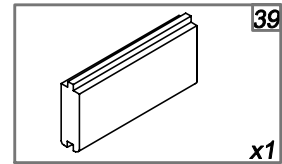
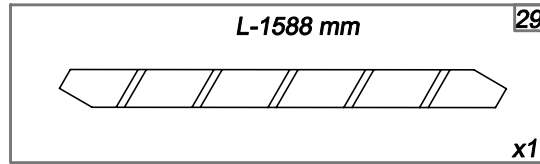
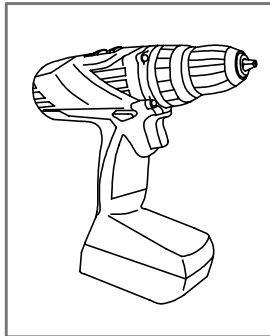
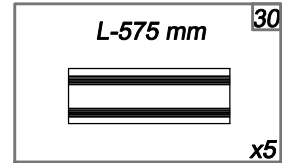
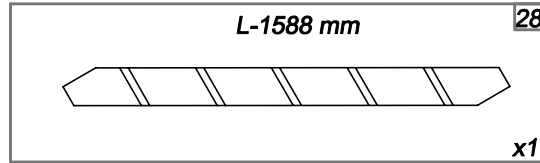
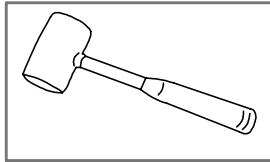

**PL** Schody drewniane

**GB** Wooden stairs

**DE** Hölzerne Treppen

**FR** L'escalier bois

**IT** Scale di legno

**NL** Houten trap



**PL** Montaż zawieszki (B1, B2). Schody mocujemy na ścianie ze wspornikiem schodów (31).

**FR** Le montage des crochets et des gâches (B1, B2). Fixez l'escalier sur la paroi avec le renfort d'escalier (31).

**GB** Installation of tag and hook kit (B1, B2). Stairs are mounted on the wall with stairs support (31).

**IT** Montaggio del manico (B1, B2). Le scale sono fissate al muro con uno sbalzo di scale (31).

**DE** Installation der Aufhänger und des Haken-Satzes (B1, B2). Treppen sind an der Wand mit Treppen-Unterstützung montiert (31).

**NL** Installatie van het inhaak systeem (B1, B2). Trap wordt aan de bovenrand gemonteerd (31).

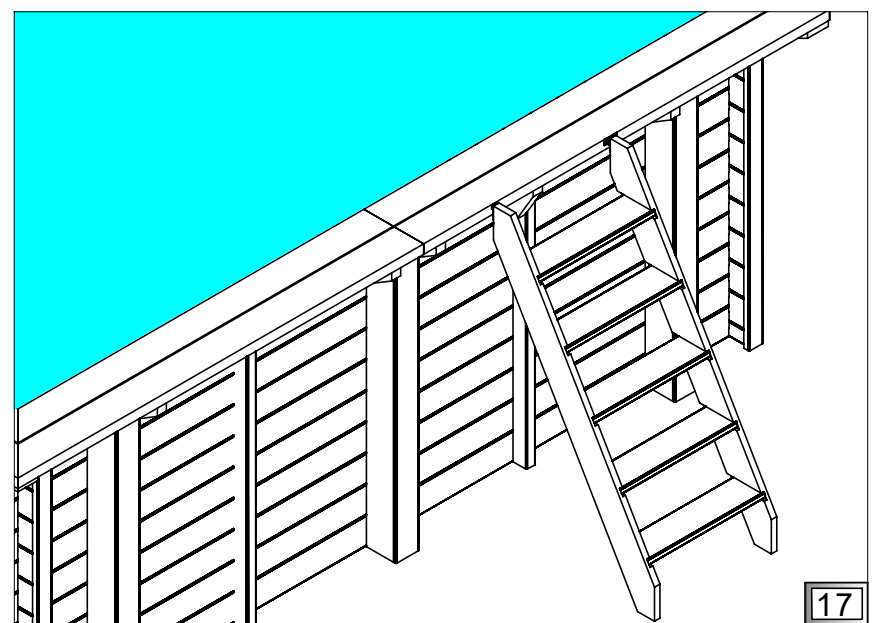
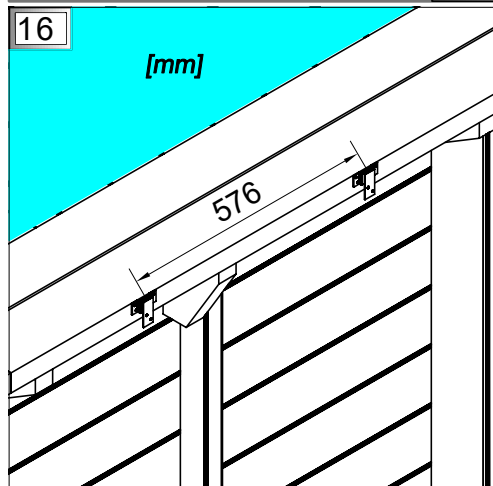
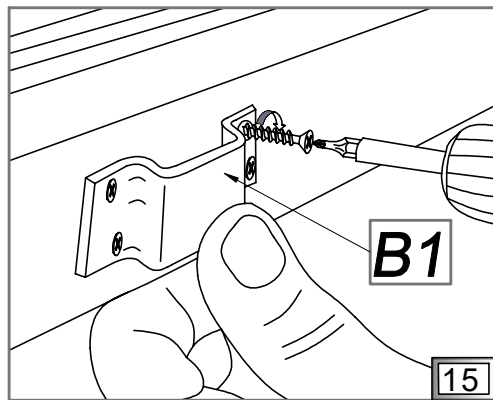
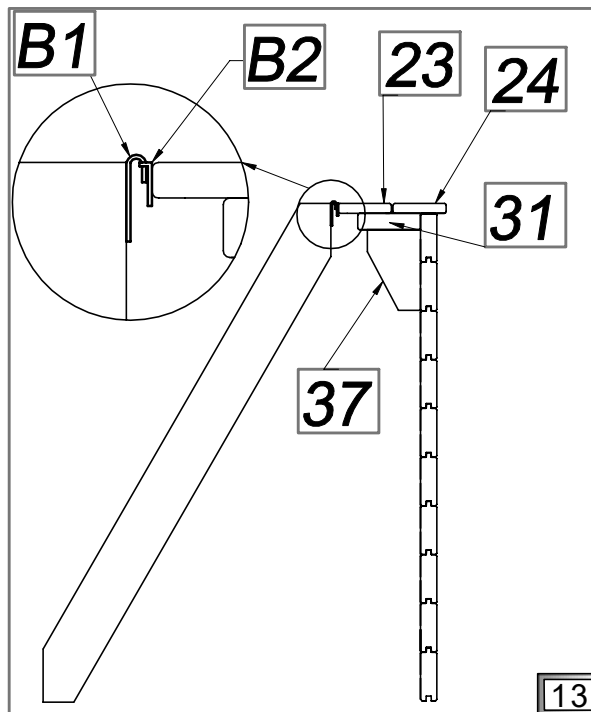
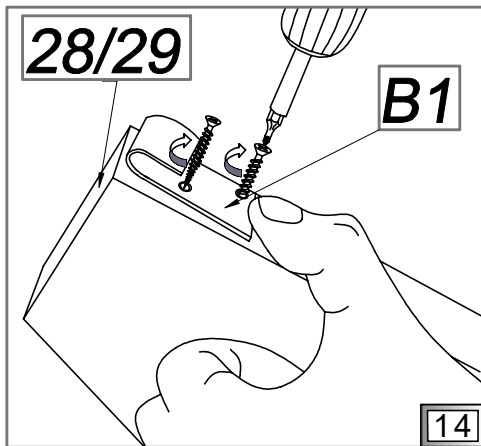
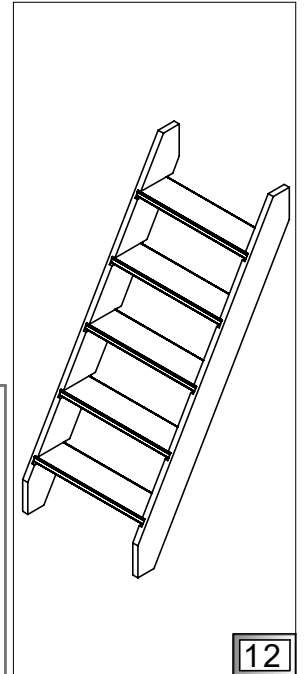
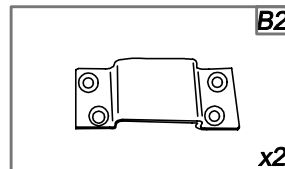
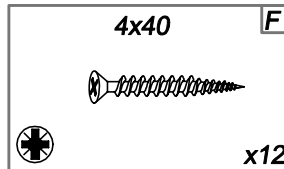
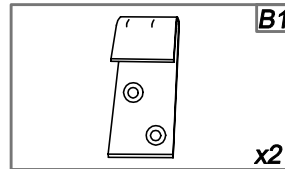
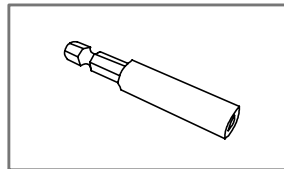
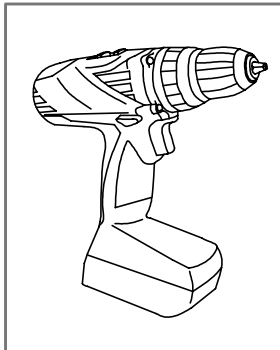

**(PL)** Drabinka stalowa

**(GB)** Stainless steel ladder

**(DE)** Leiter aus Edelstahl

**(FR)** L'échelle inox

**(IT)** Scaletta in acciaio

**(NL)** Roestvrijstalen ladder



**(PL)** Montaż stalowej drabinki wewnętrznej do desek tarasowych.

**(FR)** Fixation de l'échelle inox aux margelles.

**(GB)** Mounting stainless steel ladder to the terrace boards.

**(IT)** Montaggio della scala interna alle tavole da terrazza.

**(DE)** Montage der Edelstahlleiter an die Terrassendielen.

**(NL)** Montage van roestvrijstalen ladder op de terrasplanken.

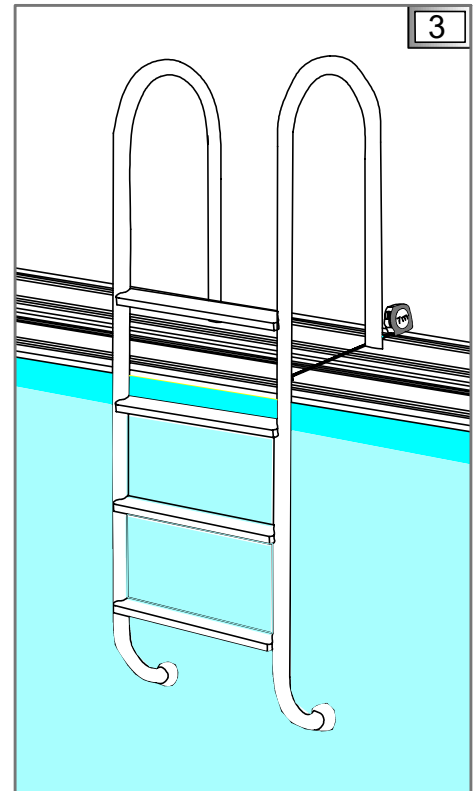
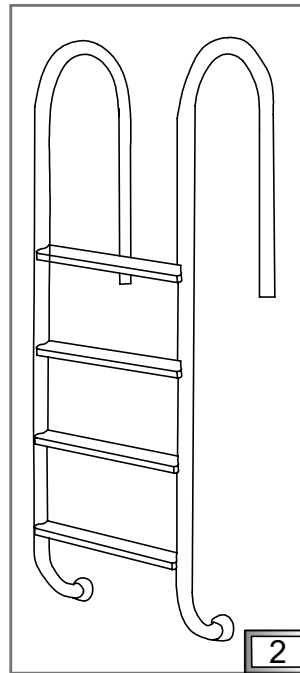
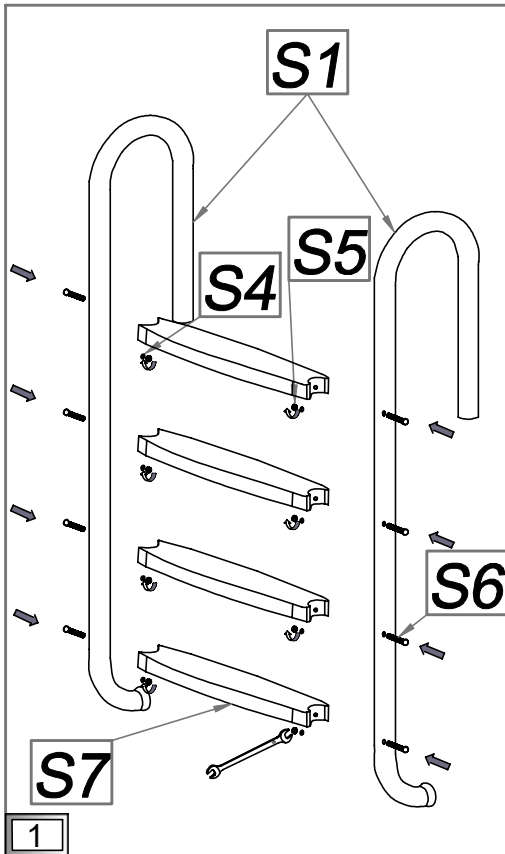
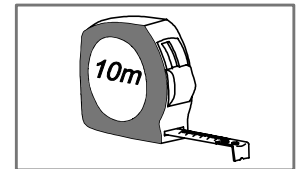
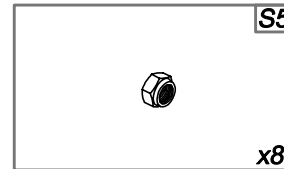
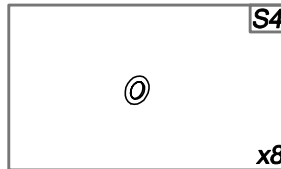
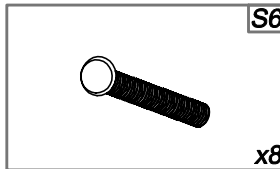
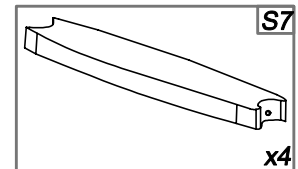
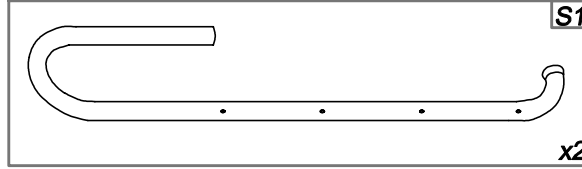
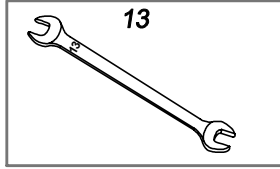

**(PL)** Drabinka stalowa

**(GB)** Stainless steel ladder

**(DE)** Leiter aus Edelstahl

**(FR)** L'échelle inox

**(IT)** Scaletta in acciaio

**(NL)** Roestvrijstalen ladder



**(PL)** Montaż stalowej drabinki wewnętrznej do desek tarasowych.

**(FR)** Fixation de l'échelle inox aux margelles.

**(GB)** Mounting stainless steel ladder to the terrace boards.

**(IT)** Montaggio della scala interna alle tavole da terrazza.

**(DE)** Montage der Edelstahlleiter an die Terrassendielen.

**(NL)** Montage van roestvrijstalen ladder op de terrasplanken.

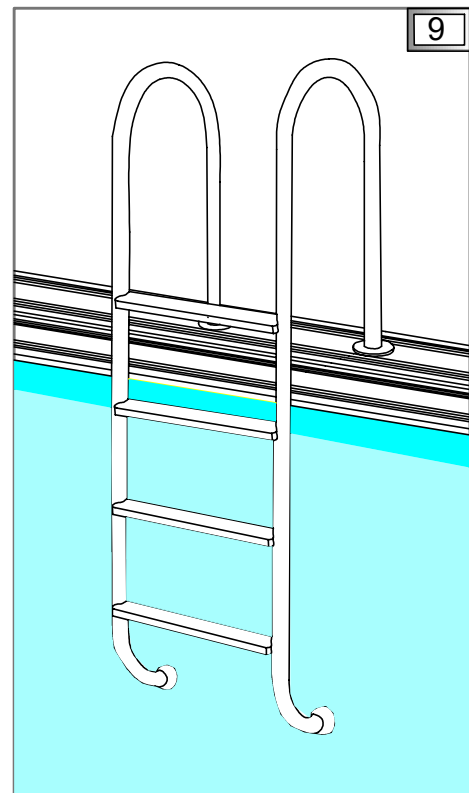
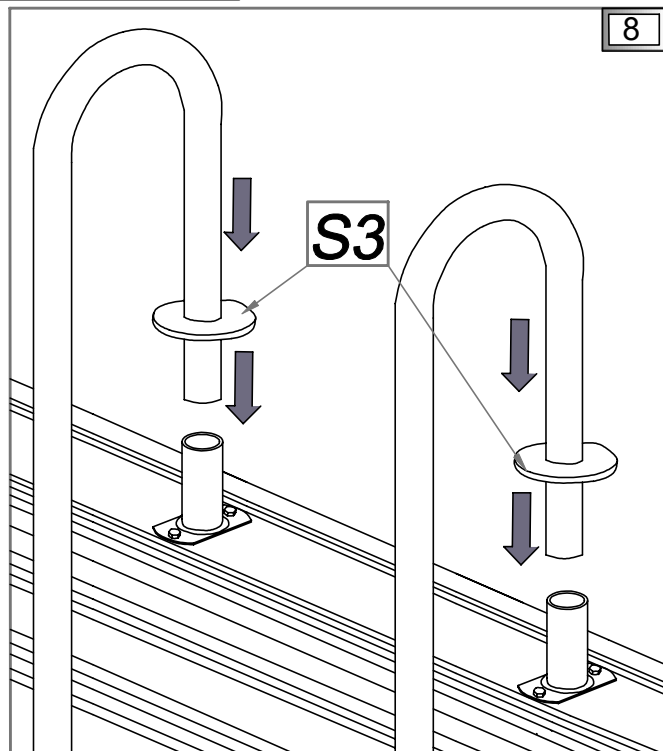
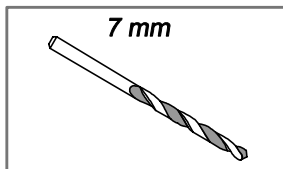
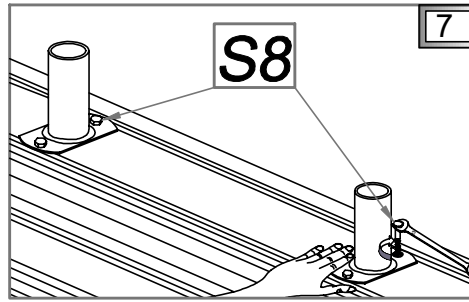
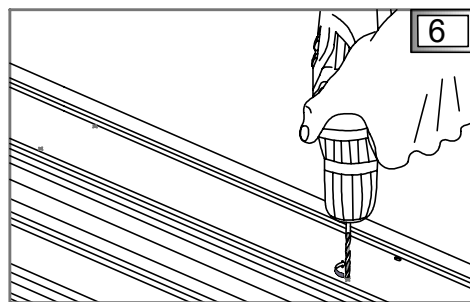
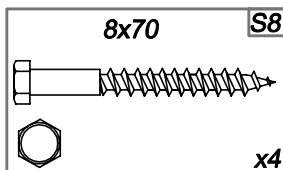
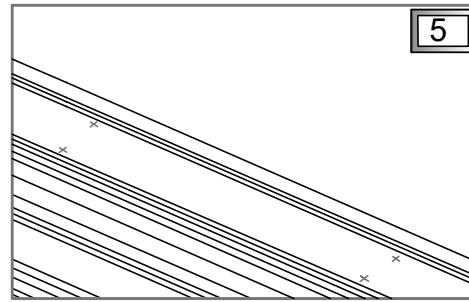
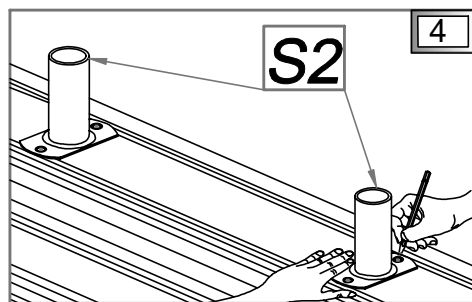
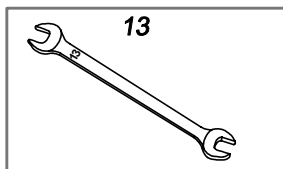
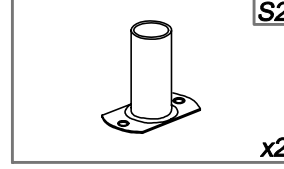
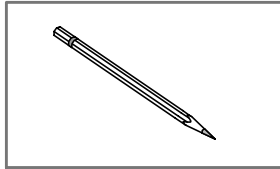
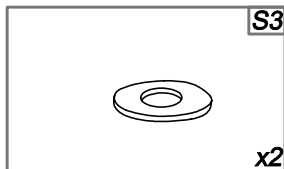
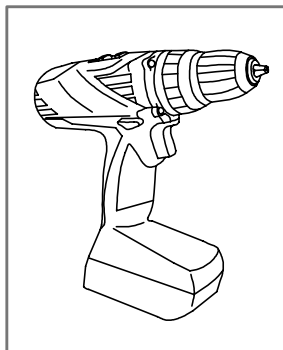



**(PL) Drabinka stalowa**

**(GB) Stainless steel ladder**

**(DE) Leiter aus Edelstahl.**

**(FR) L'échelle inox**

**(IT) Scaletta in acciaio**

**(NL) Roestvrijstalen ladder.**



**(PL) Montaż stalowej drabinki wewnętrznej do desek tarasowych.**

**(FR) Fixation de l'échelle inox aux margelles.**

**(GB) Mounting stainless steel ladder to the terrace boards.**

**(IT) Montaggio della scala interna alle tavole da terrazza.**

**(DE) Montage der Edelstahlleiter an die Terrassendielen.**

**(NL) Montage van roestvrijstalen ladder op de terrasplanken.**

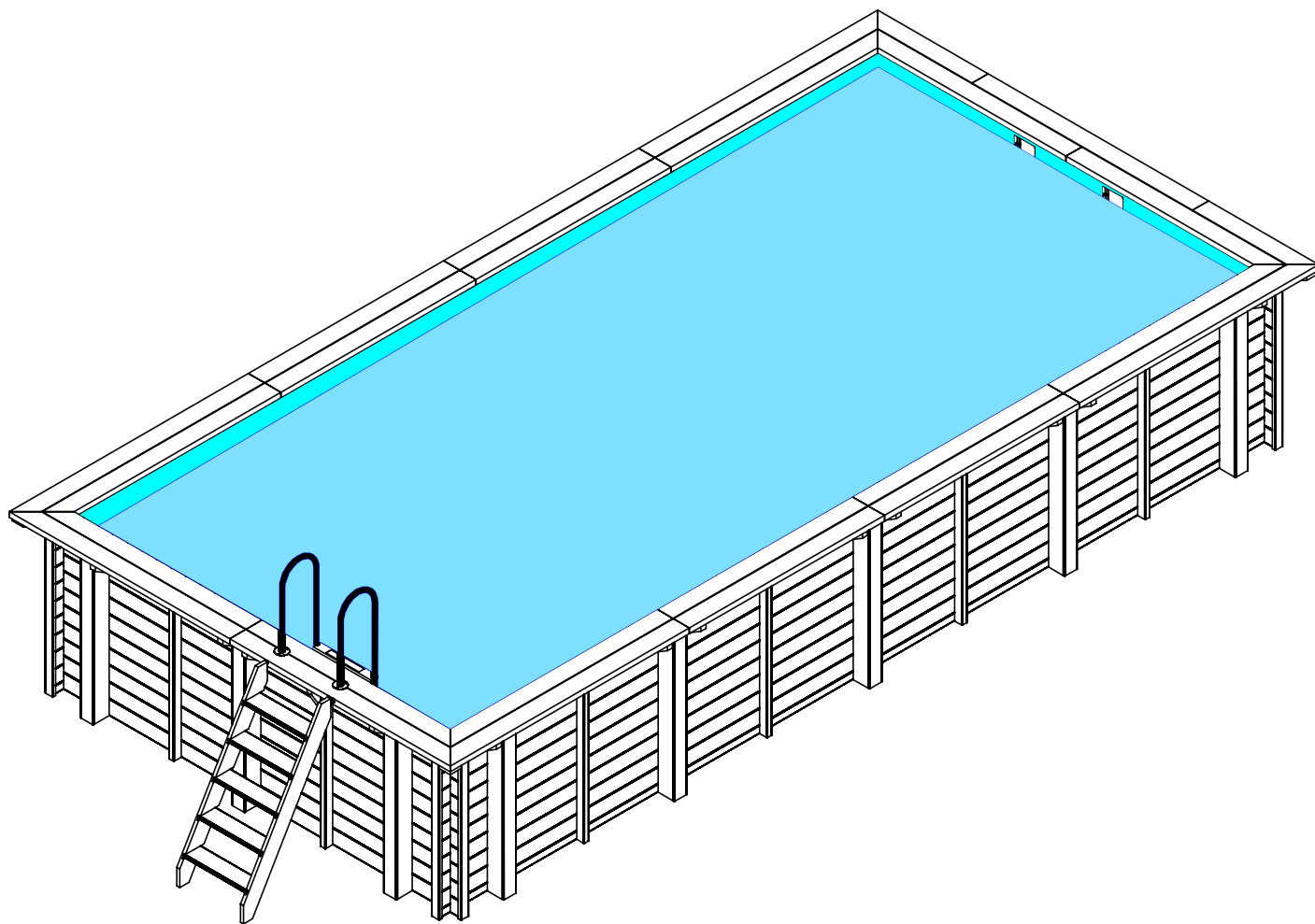

**(PL) Maskownice**

**(GB) Corners covers**

**(DE) Eck-Abdeckungen**

**(FR) Les caches**

**(IT) Mascherini**

**(NL) Covers voor de hoeken**



- (PL)** Montaż maskownic (Y) do desek tarasowych.
- (FR)** Montage des caches (Y) pour les margelles.
- (GB)** Mounting covers (Y) for corners of terrace boards.
- (IT)** Montaggio di mascherini (Y) per le tavole da terrazza.
- (DE)** Montage der Abdeckungen (Y) ans Terrassenholz.
- (NL)** Montage van covers (Y) voor de hoeken van de terrasplanken.

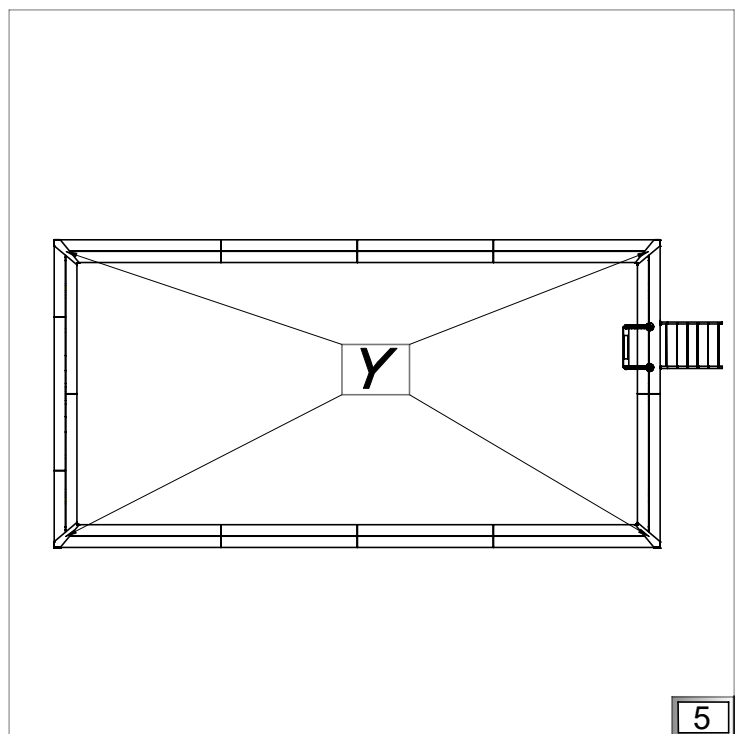
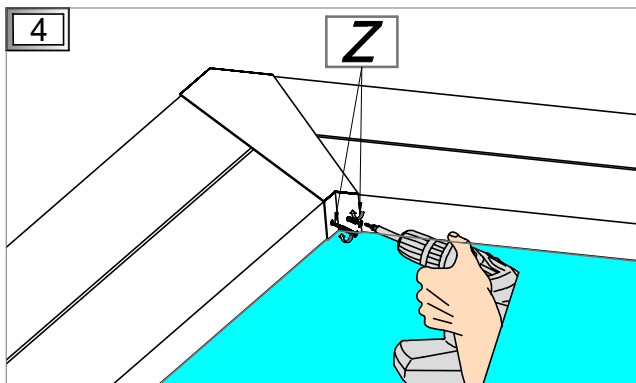
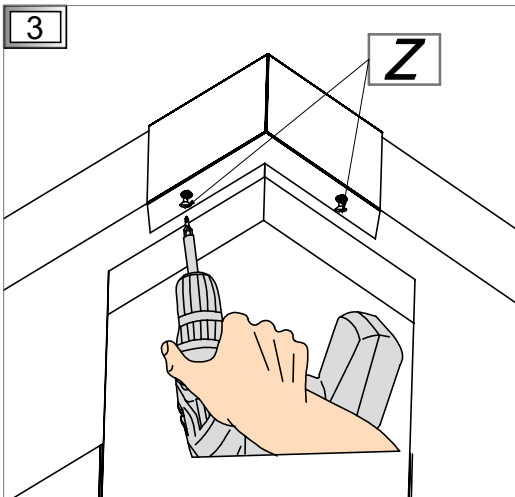
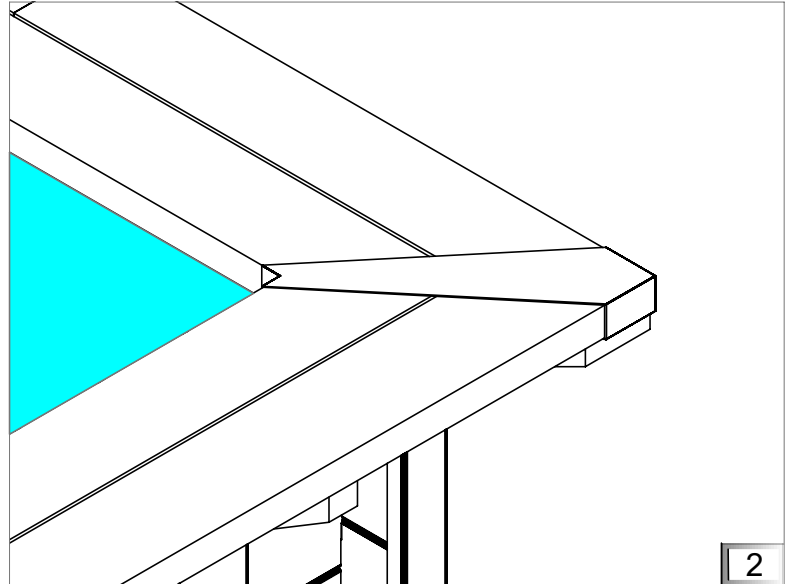
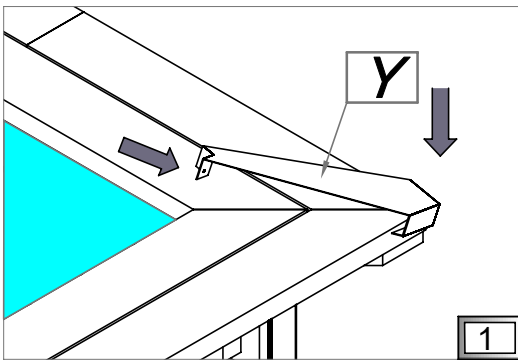
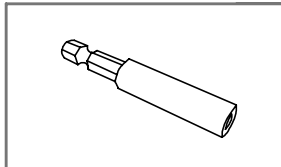
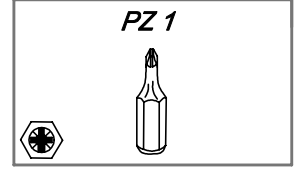
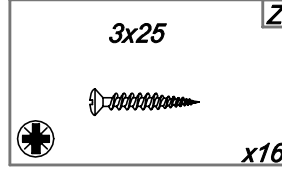
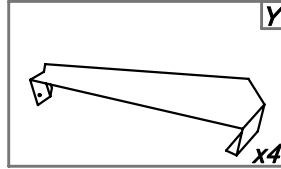
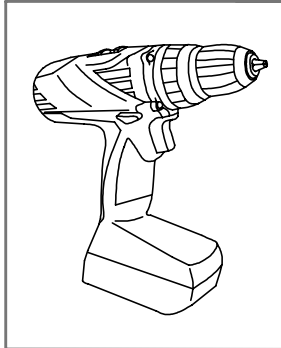

**(PL) Maskownice**

**(GB) Corners covers**

**(DE) Eck-Abdeckungen**

**(FR) Les caches**

**(IT) Mascherini**

**(NL) Covers voor de hoeken**



**(PL) Montaż maskownic (X) do desek tarasowych.**

**(FR) Montage des caches (X) pour les margelles.**

**(GB) Mounting covers (X) for corners of terrace boards.**

**(IT) Montaggio di mascherini (X) per le tavole da terrazza.**

**(DE) Montage der Abdeckungen (X) ans Terrassenholz.**

**(NL) Montage van covers (X) voor de hoeken van de terrasplanken.**

