



*MUSICflow* HS9

**SMART Hi-Fi AUDIO**  
Wireless Multi-room Sound Bar

Model : MUSICFLOWHS9



**ENGLISH | OWNER'S MANUAL**

Please read this manual carefully before operating your speaker and retain it for future reference.



## Safety Information



**CAUTION:** TO REDUCE THE RISK OF ELECTRIC SHOCK DO NOT REMOVE COVER (OR BACK) NO USER-SERVICEABLE PARTS INSIDE REFER SERVICING TO QUALIFIED SERVICE PERSONNEL.



This lightning flash with arrowhead symbol within an equilateral triangle is intended to alert the user to the presence of uninsulated dangerous voltage within the product's enclosure that may be of sufficient magnitude to constitute a risk of electric shock to persons.



The exclamation point within an equilateral triangle is intended to alert the user to the presence of important operating and maintenance (servicing) instructions in the literature accompanying the product.

**WARNING:** TO PREVENT FIRE OR ELECTRIC SHOCK HAZARD, DO NOT EXPOSE THIS PRODUCT TO RAIN OR MOISTURE.

**WARNING:** Do not install this equipment in a confined space such as a book case or similar unit.

**CAUTION:** Do not use high voltage products around this product. (ex. Electrical swatter) This product may malfunction due to electrical shock.

**CAUTION:** The apparatus shall not be exposed to water (dripping or splashing) and no objects filled with liquids, such as vases, shall be placed on the apparatus.

**CAUTION:** Do not block any ventilation openings. Install in accordance with the manufacturer's instructions.

Slots and openings in the cabinet are provided for ventilation and to ensure reliable operation of the product and to protect it from over heating. The openings shall be never be blocked by placing the product on a bed, sofa, rug or other similar surface. This product shall not be placed in a built-in installation such as a bookcase or rack unless proper ventilation is provided or the manufacturer's instruction has been adhered to.

**NOTICE:** For safety marking information including product identification and supply ratings, please refer to the main label on the bottom or rear of the apparatus.

### For models using an adapter

Only use the AC adapter supplied with this device. Do not use a power supply from another device or another manufacturer. Using any other power cable or power supply may cause damage to the device and void your warranty.

### CAUTION concerning the Power Cord

Most appliances recommend they be placed upon a dedicated circuit;

That is, a single outlet circuit which powers only that appliance and has no additional outlets or branch circuits. Check the specification page of this owner's manual to be certain. Do not overload wall outlets. Overloaded wall outlets, loose or damaged wall outlets, extension cords, frayed power cords, or damaged or cracked wire insulation are dangerous. Any of these conditions could result in electric shock or fire. Periodically examine the cord of your appliance, and if its appearance indicates damage or deterioration, unplug it, discontinue use of the appliance, and have the cord replaced with an exact replacement part by an authorized service center. Protect the power cord from physical or mechanical abuse, such as being twisted, kinked, pinched, closed in a door, or walked upon. Pay particular attention to plugs, wall outlets, and the point where the cord exits the appliance. The Power Plug is the disconnecting device. In case of an emergency, the Power Plug must remain readily accessible.

This device is equipped with a portable battery or accumulator.

**Safety way to remove the battery from the equipment:** Remove the old battery or battery pack, follow the steps in reverse order than the assembly. To prevent contamination of the environment and bring on possible threat to human and animal health, the old battery or the battery put it in the appropriate container at designated collection points. Do not dispose of batteries or battery together with other waste. It is recommended that you use local, free reimbursement systems batteries and accumulators. The battery should not be exposed to excessive heat such as sunshine, fire or the like.

### Disposal of your old appliance



1. When this crossed-out wheeled bin symbol is attached to a product it means the product is covered by the European Directive 2002/96/EC.
2. All electrical and electronic products should be disposed of separately from the municipal waste stream via designated collection facilities appointed by the government or the local authorities.
3. The correct disposal of your old appliance will help prevent potential negative consequences for the environment and human health.
4. For more detailed information about disposal of your old appliance, please contact your city office, waste disposal service or the shop where you purchased the product.

### Disposal of waste batteries/accumulators



1. When this crossed-out wheeled bin symbol is attached to batteries/accumulators of Your product it means they are covered by European Directive 2006/66/EC.
2. This symbol may be combined with chemical symbols for mercury(Hg), cadmium(Cd) or lead(Pb) if the battery Contains more that 0.0005% of mercury,0.002% of cadmium or 0.004% of lead.
3. All batteries/accumulators should be disposed separately from the municipal waste stream via designated collection facilities appointed by the government or the local authorities.
4. The correct disposal of Your old batteries/accumulators will help to prevent potential negative consequences for the environment, animal and human health.
5. For more detailed information about disposal of Your old batteries/accumulators, please contact Your city office, waste disposal service or the shop where You purchased the product.

## Declaration of Conformity

# CE 01970

Hereby, LG Electronics European Shared Service Center B.V., declares that this Wireless Multi-room Sound Bar is compliant with the essential requirements and other relevant provisions of Directive 1999/5/EC. The complete Declaration of Conformity may be requested through the following postal address:

LG Electronics European Shared Service Center B.V.  
European Standard Team  
Krijgsman 1  
1186 DM Amstelveen  
The Netherlands

or can be requested at our dedicated DoC website:  
<http://www.lg.com/global/support/cedoc/cedoc#>

This device is a 2.4 GHz and 5 GHz wideband transmission system, intended for use in all EU member states and EFTA countries, with indoor use restriction for 5 GHz band. (5150 – 5250 MHz)

This device should be installed and operated with minimum distance 20 cm between the device and your body. And this phrase is for the general statement for consideration of user environment.

# Table of Contents

## 1 Getting Started

---

- 3 Safety Information
- 8 Main Features
- 8 Introduction
- 9 Accessories
- 10 Front panel
- 10 Rear panel
- 11 Remote control
- 12 Installing the sound bar
  - 12 – Installing the cover foot
- 12 Mounting the main unit on a wall

## 2 Connecting

---

- 14 Wireless subwoofer connection
- 15 Connection overview
- 15 Connecting to your TV
  - 15 – Using an OPTICAL cable
  - 16 – LG Sound Sync
  - 17 – Using an HDMI cable
  - 17 – Enjoy rich sound broadcast of the channel with the sound bar
  - 18 – What is SIMPLINK?
  - 18 – ARC (Audio Return Channel) function
  - 19 – Additional information for HDMI
- 19 Optional equipment connection
  - 19 – HDMI connection
  - 20 – PORT. (Portable) IN connection
  - 21 – OPTICAL IN connection
  - 21 – Connecting IR Blaster
- 22 Understanding Network Connection
  - 22 – Basic Connection
  - 22 – Group playback using Music Flow Player app
- 23 Installing “Music Flow Player” App
  - 24 – Starting with Music Flow Player app
- 25 Connecting the speaker to your Home Network
  - 25 – Connecting the speaker to your network with a LAN cable

- 27 – Connecting the speaker to your Network via the Wi-Fi Setup Method (Android)
- 30 – Connecting the speaker to your Network via the Wi-Fi Setup Method (iOS)

- 34 Connecting the speakers to your Home Network (Additional)
  - 34 – Adding another speaker

## 3 Operating

---

- 37 Enjoying the Music with Music Flow Player app
  - 37 – Overview of Home menu
  - 38 – Overview of the side menu
  - 38 – Playing a song
  - 40 – Overview of Playback
  - 41 Different ways of listening to music
    - 42 – Group Playback
    - 43 – Surround playback
    - 44 – Seamless playback
  - 45 Using LG HomeChat
    - 45 – About LG HomeChat
    - 45 – How to start LG HomeChat
    - 47 – Usage Examples
    - 48 – Overview of setting menu
    - 49 – [General] Menu
    - 49 – [Speakers] Menu
    - 50 – [Alarms/Sleep Timer] Menu
    - 50 – [Music Library] Menu
    - 50 – [Account management] Menu
    - 51 – [Advance Settings] Menu
    - 52 – [Account management] Menu
    - 52 – [Update] Menu
    - 52 – [Open source licenses] Menu
  - 53 Using a Bluetooth Wireless Technology
    - 53 – About Bluetooth
    - 53 – Bluetooth profiles
    - 53 – Listening to Music of a Bluetooth Device
  - 54 Other operations
    - 54 – DRC (Dynamic Range Control)
    - 54 – AV Sync
    - 54 – Turn off the sound temporarily

- 55 - Displaying input source information
- 55 - Sleep timer setting
- 55 - Using your TV remote control
- 55 - Adjust the Treble/Bass/Sub-woofer
- 55 - Night mode
- 56 - AUTO POWER On/Off
- 56 Sound adjustment
  - 56 - Adjust volume level automatically
- 56 Using Media Server for PC
  - 56 - Music Flow PC Software for windows
- 57 - Nero MediaHome 4 Essentials for Mac OS
- 58 Standby mode
  - 58 - Standby mode
  - 58 - Network standby mode
- 59 Reset the Speaker
  - 59 - Resetting the speaker

## 4 Troubleshooting

---

- 60 Troubleshooting
  - 60 - General
  - 61 - Network
  - 62 - Application and PC Software

## 5 Appendix

---

- 63 File requirement
- 63 Trademarks and licenses
- 64 Specifications
- 66 Handling the Speaker
- 66 Important Information Relating to Network Services
- 67 TERMS OF USE

1

2

3

4

5

Some of the content in this manual may differ from Music Flow Player app depending on the application's version.

## Main Features

### Made for iPod/iPhone/iPad or Android device

Enjoys music from iPod/iPhone/iPad or Android device with simple connection.

### LG Sound Sync

Controls volume level of this unit by the remote control of your LG TV that is compatible with LG Sound Sync.

### Portable In

Listens to music from your portable device.

### Music Flow Player application

Listens to music stored on your smart device.

You can control this speaker with your iPod touch/iPhone/iPad or Android device via Music Flow Player app. This speaker and your smart device must be connected to the same network. Visit "iTunes store" or "Google Play Store" or use the QR code shown below to search for "Music Flow Player" app. For detailed information, refer to page 23.



(Android OS)



(Apple iOS)

- Depending on the application's version and the settings of smart device, Music Flow Player app may not be operated normally.
- Some smart devices may not be compatible with this speaker.

## Introduction

### Symbol used in this manual

#### ! Note

Indicates special notes and operating features.

#### ! Caution

Indicates cautions for preventing possible damages from abuse.



## Accessories

Please check and identify the supplied accessories.

Designs and specifications of the accessories are subject to change without prior notice.

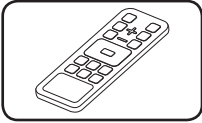

Remote control (1)

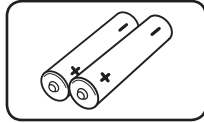

Batteries (2)

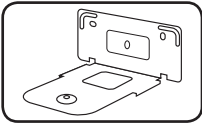

Wall bracket (2)

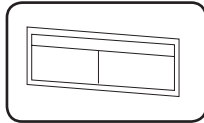

Wall bracket install guide (1)

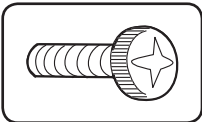

Screws (2)

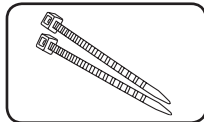

Cable ties for arranging cables (2)

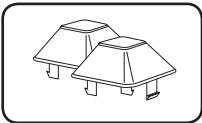

Foot

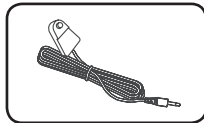

IR Blaster

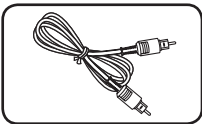

Optical

## Front panel

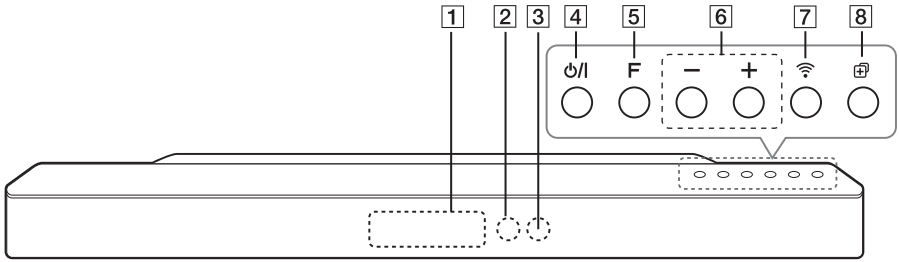

- 1** Display window
- 2** Remote sensor
- 3** LED indicator  
Shows connection status.
- 4** P / I (Standby/On)  
- Power On  
- Switching to the standby mode (page 58)
- 5** F (Function)  
Selects the function and input source.
- 6** - / + (Volume)  
Adjusts volume level.
- 7** (Wi-Fi)  
Connects your speaker to your network.  
(page 27)
- 8** (Add)  
Adds the speaker to your network. (page 34)

## Rear panel

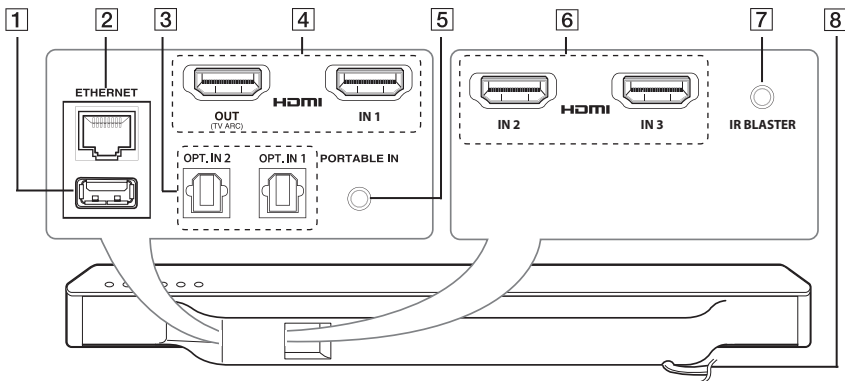

- 1** S/W download connector (For service only)
- 2** ETHERNET : LAN port
- 3** OPT. IN 2/OPT. IN 1 : Optical input
- 4** HDMI IN 1/HDMI OUT(TV ARC) : HDMI input / output
- 5** PORTABLE IN : Portable input
- 6** HDMI IN 2/HDMI IN 3 : HDMI input
- 7** IR BLASTER
- 8** AC power cord

## Remote control

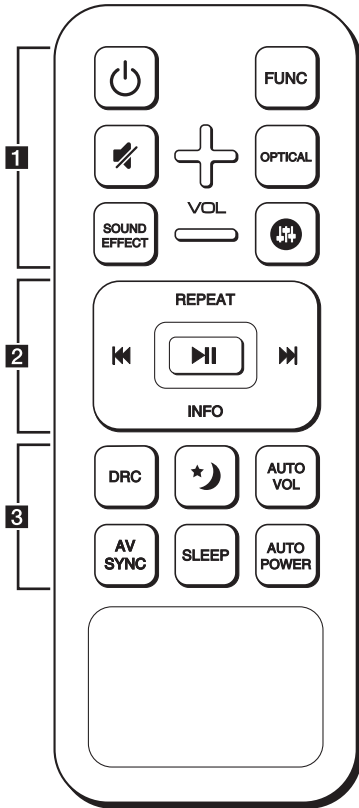

### Battery Installation

Remove the battery cover on the rear of the Remote Control, and insert two R03 (size AAA) batteries with  $\oplus$  and  $\ominus$  matched correctly.

..... **1** .....

**Power** (Power) : Switches the unit ON or OFF. / Switches to the standby mode.

**FUNC** : Selects the function and the input source.

**Mute** (Mute) : Mutes the sound.

**OPTICAL** : Changes input source to OPTICAL directly.

**Sound Level** (Sound Level) : Adjusts sound level of Treble, Bass and Subwoofer.

**VOL +/-** : Adjusts speaker volume.

..... **2** .....

**REPEAT** : Listen to your music repeated-y.

**Fast Backward / Fast Forward** (Skip) :

- Skips Fast backward or Forward.

**Play/Pause** (Play/Pause) : Starts playback. / Pauses playback.

**INFO** : Displays the input source information.

#### **Note**

You can use these playback buttons after play music by "Music Flow Player" App or PC software.

..... **3** .....

**DRC** : Turns on or off DRC function.

**Night mode** (Night mode) : Set Night mode to On to reduce the sound intensity and improve fineness and softness.

**AUTO VOL** : Turns on or off the AUTO VOLUME mode.

**AV SYNC** : Synchronizes the audio and video.

**SLEEP** : Sets the system to turn off automatically at a specified time.

**AUTO POWER** : Turns on or off AUTO POWER function. (Refer to the page 56.)

## Installing the sound bar

You can hear the sound by connecting the unit to the other device : TV, Blu-ray disc player, DVD player, etc.

Place the unit in front of the TV and connect it to the device you want. (Refer to pp. 15 - 21)

You can place the wireless subwoofer anywhere in your room. But it is better to place the subwoofer near the main unit. Turn it slightly toward the center of the room to reduce the wall reflections.

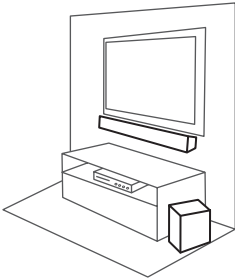

### ! Caution

- For best performance of wireless connection such as Bluetooth or wireless subwoofer, do not install the unit on Metallic furniture because wireless connection communicates through a module positioned on the bottom of the unit.
- Be careful not to make scratches on the surface of the Unit /Sub-Woofer when installing or moving them.

## Installing the cover foot

You can extend the height of the unit by using cover foot (height : 11 mm)

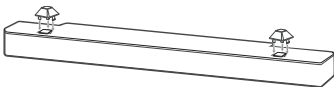

1. Turn the unit upside down.
2. Peel off a sticker attached to the cover foot. Then place it on the existing foot of the unit.
3. Press the cover foot with adequate force to get it firmly fixed.

## Mounting the main unit on a wall

You can mount the main unit on a wall.

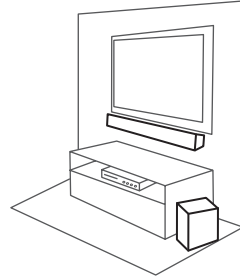

### ! Caution

Because it is difficult to make a connection after installing this unit, you should connect the cables before installation.

## Preparation materials

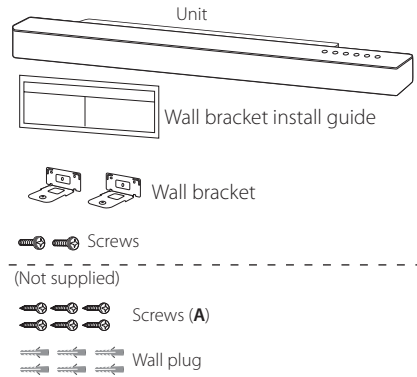

1. Match the TV's BOTTOM EDGE of Wall bracket install guide with the bottom of TV and attach to the position.

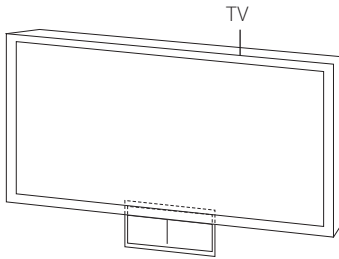

2. When you mount it on a wall (concrete), use the wall plugs. You should drill some holes. A guide sheet (Wall bracket install guide) is supplied to drill. Use the sheet to check the point to drill.

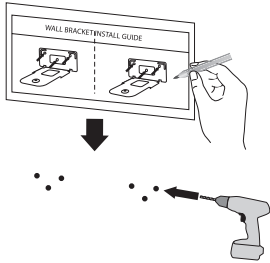

3. Remove the Wall bracket install guide.
4. Fix the brackets with screws (A) as shown in the illustration below.

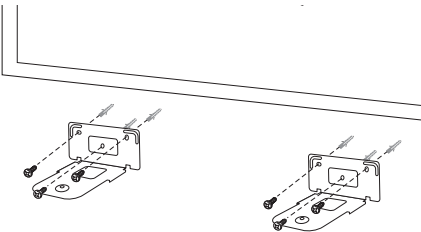

### ! Note

Screws (A) and Wall Plugs are not supplied for mounting the unit. We recommend the Hilti (HUD-1 6 x 30) for the mounting.

5. Put the unit on the brackets to match screw holes on the bottom of the unit.

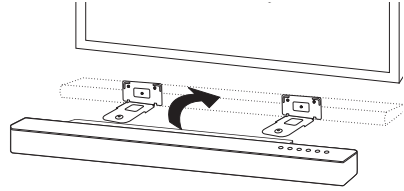

6. Fix the unit with the screws firmly.

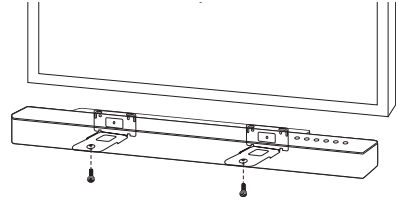

### ! Note

To detach the unit, perform it in reverse order.

### ! Caution

- Do not install this unit upside down. It can damage the parts of this unit or be the cause of personal injury.
- Do not hang onto the installed unit and avoid any impact to the unit.
- Secure the unit firmly to the wall so that it does not fall off. If the unit falls off, it may result in an injury or damage to the product.
- When the unit is installed on a wall, please make sure that a child does not pull any of connecting cables, as it may cause it to fall.

## Wireless subwoofer connection

### LED indicator of wireless subwoofer

LED Color	Status
Green (Blink)	The connection is trying.
Green	The connection is completed.
Red	The wireless subwoofer is in standby mode or the connection is failed.
Off (No display)	The power cord of wireless subwoofer is disconnected.

### Setting up the wireless subwoofer for the first time

1. Connect the power cord of the wireless subwoofer to the outlet.
2. Turn on the main unit : The main unit and wireless subwoofer will be automatically connected.

### Manually pairing wireless subwoofer

When your connection is not completed, you can see the red LED or the blinking of green LED on the wireless subwoofer and the subwoofer does not make sound. To solve the problem, follow the below steps.

1. Adjust volume level of the main unit to minimum.
  - "VOL MIN" appears on the display window.
2. Press and hold  (Mute) on the remote control for about 3 seconds.
  - "WL RESET" appears on the display window briefly.

3. If the LED of the wireless subwoofer already blinks in green continually, you can skip this step.

Press and hold **PAIRING** on the back of the wireless subwoofer for more than 5 seconds.

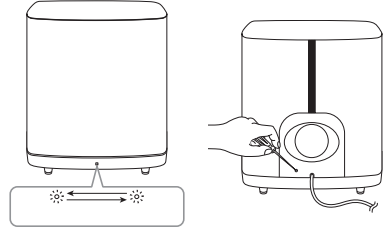

- The LED of the wireless subwoofer lights up alternately in red and green.
4. Disconnect the power cord of the main unit and the wireless subwoofer.
  5. Connect them again after the LED of the main unit and the wireless subwoofer is fully turned off.

The main unit and the wireless subwoofer will be paired automatically when you turn on the main unit.

- When the connection is completed, you can see the green LED on the subwoofer.

### Note

- It takes a few seconds (and may take longer) for the main unit and the subwoofer to communicate with each other and make sounds.
- The closer the main unit and the subwoofer, the better sound quality. It is recommended to install the main unit and the subwoofer as close as possible and avoid the cases below.
  - There is an obstacle between the main unit and the subwoofer.
  - There is a device using same frequency with this wireless connection such as a medical equipment, a microwave or a wireless LAN device.

## Connection overview

Connect or disconnect the jack in order of the image.

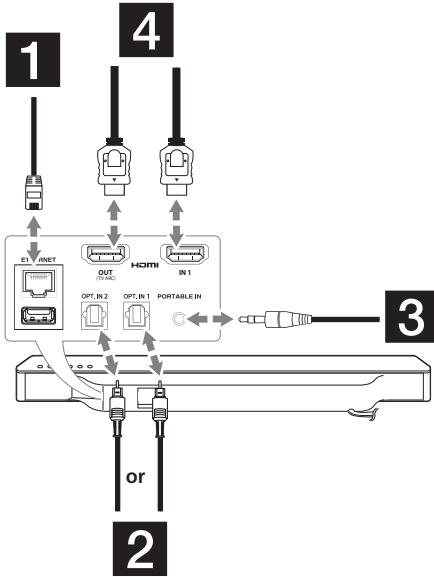

## Connecting to your TV

Please connect with this unit and TV using the optical digital cable or HDMI cable considering the state of the TV.

### Using an OPTICAL cable

1. Connect the OPT. IN 1 or OPT. IN 2 jack on the back of the unit to OPTICAL OUT jack on the TV using an OPTICAL cable.

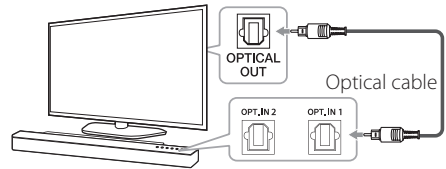

2. Set the input source to OPTICAL. Press repeatedly **FUNC** on the remote control or **F** on the unit until the function is selected. To directly select the OPTICAL 1 or OPTICAL 2 function, press **OPTICAL** on the remote control.

#### ! Note

- You can enjoy the TV audio through the speakers of this unit. In the case of some TV models, you must select the external speaker option from the TV menu. (For details, reference your TV user manual.)
- Set up the sound output of TV to listen to the sound through this unit :  
TV setting menu → [Sound] → [TV Sound output] → [External speaker (Optical)]
- Details of TV setting menu vary depending on the manufacturers or models of your TV.

## LG Sound Sync

# Sound Sync

You can control some functions of this unit by your TV's remote control with LG Sound Sync. It is compatible with the LG TV that is supported LG Sound Sync. Make sure of the LG Sound Sync logo on your TV.

Controllable function by LG TV's remote control :  
Volume up/down, mute

Refer to the TV's instruction manual for the details of LG Sound Sync.

Make one of the following connections, depending on the capabilities of your equipment.

### ! Note

- You can also use the remote control of this unit while using LG Sound Sync. If you use TV's remote control again, the unit synchronizes with the TV.
- When the connection fails, make sure of the condition of the TV and power.
- Make sure of the condition of this unit and the connection in the cases below when using LG Sound Sync.
  - Turn off the unit.
  - Changing the function to the others.
  - Disconnecting the optical cable.
- The amount of time to turn off this unit is different depending on your TV when you set AUTO POWER function to ON.

## With wired connection

1. Connect your LG TV to the unit by using an optical cable.

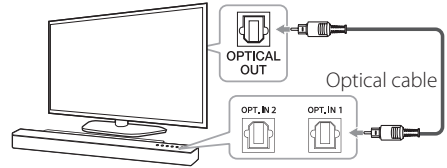

2. Set up the sound output of TV to listen to the sound through this unit :  
TV setting menu → [Sound] → [TV Sound output] → [LG Sound Sync (Optical)]
3. Turn on the unit by pressing **⏻** (Power) on the remote control.
4. Select OPTICAL function by using **FUNC** on the remote control or **F** on the unit until the function is selected.  
You can see "LG OPT" on the display window if connecting normally between this unit and your TV.

### ! Note

Details of TV setting menu vary depending on the manufacturers or models of your TV.

## With wireless connection

1. Turn on the unit by pressing **⏻** (Power) on the remote control.
2. Select LG TV function by using **FUNC** on the remote control or **F** on the unit until the function is selected.
3. Set up LG Sound Sync (Wireless) on the TV. Refer to the TV's instruction manual.

"PAIRED" appears on the display window for about 3 seconds and then you can see "LG TV" on the display window if connecting normally between this unit and your TV.

### ! Note

If you turned off the unit directly by pressing **⏻** (Power), LG Sound Sync (Wireless) will be disconnected. To use this function again, you should reconnect the TV and the unit.



## Using an HDMI cable

If you connect this unit to a TV that supports HDMI CEC and ARC (Audio Return Channel), you can enjoy the TV audio through the speakers of this unit without connecting the optical cable.

Connect the HDMI OUT (TV ARC) jack on the back of the unit to ARC jack on the TV using an HDMI cable.

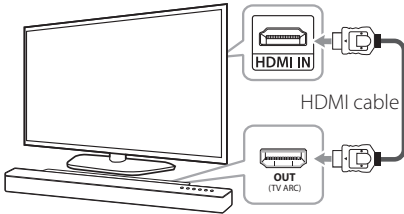

### ! Note

- HDMI CEC (Consumer Electronics Control): Using a single remote control, you have the ability to operate CEC compatible devices (TV, Sound Bar, Blue-ray player, etc.)
- You can also enjoy extra functions such as Bluetooth with **FUNC** on remote control or **F** on this unit. When you go back to live TV channel after using the extra functions (Bluetooth) of this audio system, you should choose your preferred speaker on TV to enjoy the sound from this audio system again.

## HDMI cable Checklist

Some HDMI cables do not support the ARC function, this can result in no sound output.

When connecting this unit to the TV, if there is no sound, there might be a problem with the HDMI cable. Therefore connect this unit to the TV and check whether the Type A, High speed HDMI™ Cable with Ethernet.

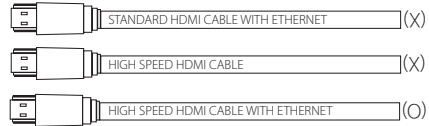

## Enjoy rich sound broadcast of the channel with the sound bar

### Connection through HDMI Cable

Your television must support the newest HDMI features (HDMI CEC<sup>1)</sup> / ARC (Audio Return Channel) to fully enjoy the Live broadcasting channel with audio system through an HDMI cable. Unless your TV supports these HDMI features, the audio system should be connected through an OPTICAL cable.

1) HDMI CEC (High-Definition Multimedia Interface Consumer Electronics Control)

Consumer Electronics Control (CEC) is an HDMI feature designed to allow the user to command and control the CEC-enabled devices, that are connected through HDMI by using only one of their remote controls.

※ Trade names for CEC are SimpLink (LG), Anynet+ (Samsung), BRAVIA Sync (Sony), EasyLink (Philips), etc.

## What is SIMPLINK?



Some functions of this unit are controlled by the TV's remote control when this unit and LG TV's with SIMPLINK are connected through HDMI connection.

Controllable functions by LG TV's remote control : Power on/off, volume up/down, etc.

Refer to the TV owner's manual for the details of SIMPLINK function.

LG TV's with SIMPLINK function has the logo as shown above.

### ! Note

- Depending on the state of the unit, some SIMPLINK operation may differ from your purpose or not work.
- Depending on a TV or a player which is connected with this unit, SIMPLINK operation may differ from your purpose.

## ARC (Audio Return Channel) function

The ARC function enables an HDMI capable TV to send the audio stream to HDMI OUT of the unit.

To use this function :

- Your TV must support the HDMI-CEC and ARC function and the HDMI-CEC and ARC must be set to On.
- The setting method of HDMI-CEC and ARC may differ depending on the TV. For details about ARC function, refer to your TV manual.
- You must use the HDMI cable (Type A, High Speed HDMI™ cable with Ethernet).
- You must connect the HDMI OUT on the unit with HDMI IN of the TV that supports ARC function using an HDMI cable.
- You can connect only one Sound bar to TV compatible with ARC.

### ! Note

- ARC function is automatically selected when ARC signal comes in from TV, no matter what kind of the function you are using.
- You can enjoy the TV audio through the speakers of this unit. In the case of some TV models, you must select the external speaker option from the TV menu. (For details, reference your TV user manual.)
- Set up the sound output of TV to listen to the sound through this unit :  
TV setting menu → [Sound] → [TV Sound output] → [External speaker (HDMI ARC)]
- Details of TV setting menu vary depending on the manufacturers or models of your TV.

## Additional information for HDMI

- When you connect an HDMI or DVI compatible device make sure of the following:
  - Try switching off the HDMI/DVI device and this player. Next, switch on the HDMI/DVI device and leave it for around 30 seconds, then switch on this player.
  - The connected device's video input is set correctly for this unit.
  - The connected device is compatible with 720 x 576p, 1280 x 720p, 1920 x 1080i or 1920 x 1080p video input.
- Not all HDCP-compatible HDMI or DVI devices will work with this player.
  - The picture will not be displayed properly with non-HDCP device.

### ! Note

- If a connected HDMI device does not accept the audio output of the player, the HDMI device's audio sound may be distorted or may not output.
- Changing the resolution when the connection has already been established may result in malfunctions. To solve the problem, turn off the player and then turn it on again.
- When the HDMI connection with HDCP is not verified, TV screen is changed to black screen. In this case, check the HDMI connection, or disconnect the HDMI cable.
- If there are noises or lines on the screen, please check the HDMI cable (length is generally limited to 4.5 m(15 ft).
- You cannot change the video resolution in the HDMI IN mode. Change the video resolution of the connected component.
- If the video output signal is abnormal when your personal computer is connected to HDMI IN jack, change the resolution of your personal computer to 576p, 720p, 1080i or 1080p.

## Optional equipment connection

### HDMI connection

#### For enjoying sound only

You can enjoy the sound from the external device you connect.

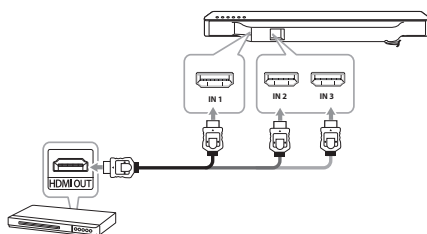

To the Blu-ray disc player, DVD player, etc.

1. Connect HDMI IN 1, HDMI IN 2 or HDMI IN 3 jack on the back of the unit to HDMI OUT jack on the audio device such as Blu-ray disc player, DVD player, etc.
2. Set the input source to HDMI IN 1, HDMI IN 2 or HDMI IN 3. Press repeatedly **FUNC** on the remote control or **F** on the unit until the function is selected.

## For enjoying both sound and picture

You can enjoy both sound and picture from the external device you connect.

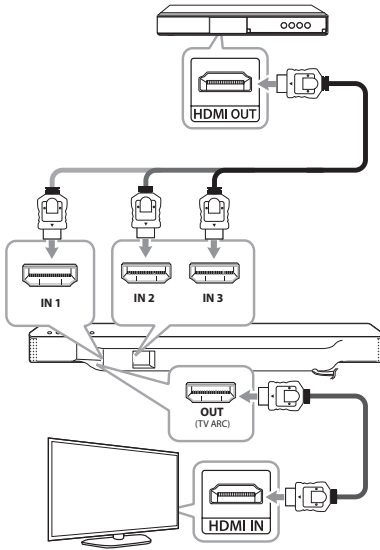

1. Connect HDMI IN 1, HDMI IN 2 or HDMI IN 3 jack on the back of the unit to HDMI OUT jack on the external device such as Blu-ray disc player, DVD player, etc.
2. Connect HDMI OUT (TV ARC) jack on the back of the unit to HDMI IN jack on the TV.
3. Set the input source to HDMI IN 1, HDMI IN 2 or HDMI IN 3. Press repeatedly **FUNC** on the remote control or **F** on the unit until the function is selected.

### ! Note

- With the unit connected to external devices and TV as above illustration, TV will output picture and sound from external devices when the unit is turned off in HDMI IN mode.
- HDMI OUT jack is for TV connection. Even though PCM multi channel is inputted to the unit through an HDMI cable, the unit can only output 2 channel to TV.
- Audio sources without any transformation pass through this unit when this unit is turned off.

## PORT. (Portable) IN connection

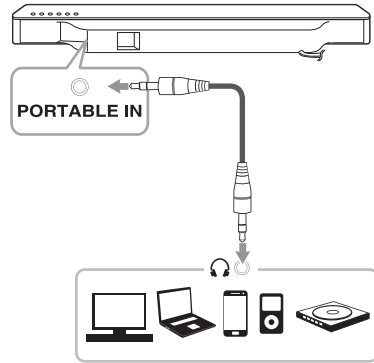

### Listening to music from your portable player

The unit can be used to play the music from many types of portable players or external devices.

1. Connect the portable player to the PORTABLE IN connector of the unit.
2. Turn the power on by pressing  (Power).
3. Select the PORTABLE function by pressing **FUNC** on the remote control or **F** on the unit until the function is selected.
4. Turn on the portable player or external device and start playing it.

## OPTICAL IN connection

Connect an optical output jack of external devices to the OPT. IN jack.

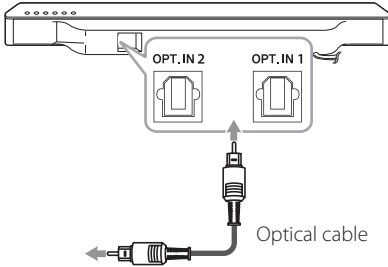

1. Connect the OPT. IN 1 or OPT. IN 2 jack on the back of the unit to optical out jack of your TV (or digital device etc.)
2. Select the input source to OPTICAL by pressing **FUNC** on the remote control or **F** on the unit until the function is selected.

To directly select the OPTICAL 1 or OPTICAL 2 function, press **OPTICAL** on the remote control.

3. Listen to sound from the connected device.
4. Press **OPTICAL** to exit from OPTICAL. Function is returned to previous one.

## Connecting IR Blaster

IR blaster is supplied as an accessory with the unit in order to communicate well with the remote control and the TV.

Remote control of your TV may not be operated if the unit hides the remote sensor of the TV.

You can solve the problem by connecting IR blaster with LG TV.

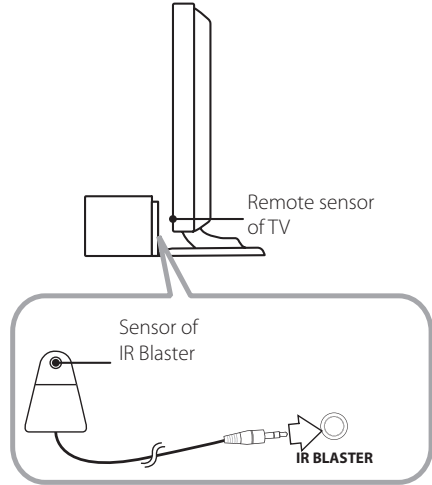

1. Remove the protective vinyl of IR blaster.
2. Put IR blaster on the back of the unit with the sensor of IR blaster facing the remote sensor of the TV.
3. Connect the end of IR blaster to IR BLASTER jack.

### Caution

- Do not block ventilation when you put IR blaster on the unit.
- Do not disconnect the power cord. If you want to use IR blaster, keep the unit on standby mode.

### Note

Depending on your TV, some or all buttons may not be function on the TV.

# Understanding Network Connection

## Basic Connection

- A** Wired or Wi-Fi connection to router.
- B** Wired and wireless connection.  
You can use multiple speakers in a multi-room configuration.

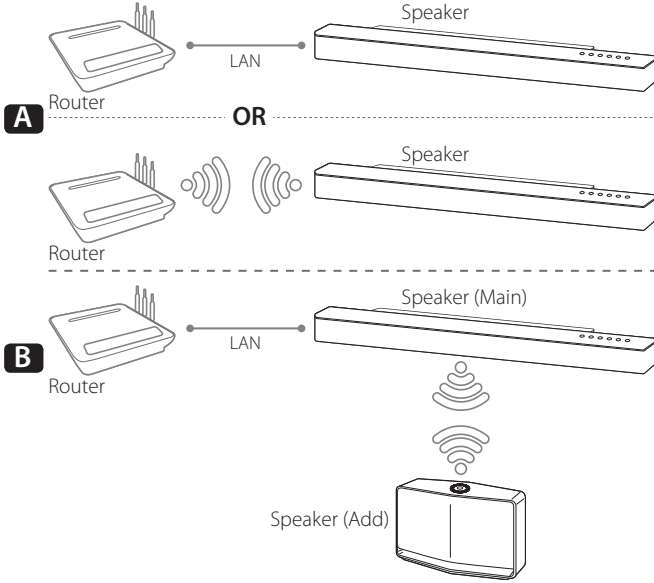

## Group playback using Music Flow Player app

You can use multiple speakers in a multi-room configuration. (page 42)

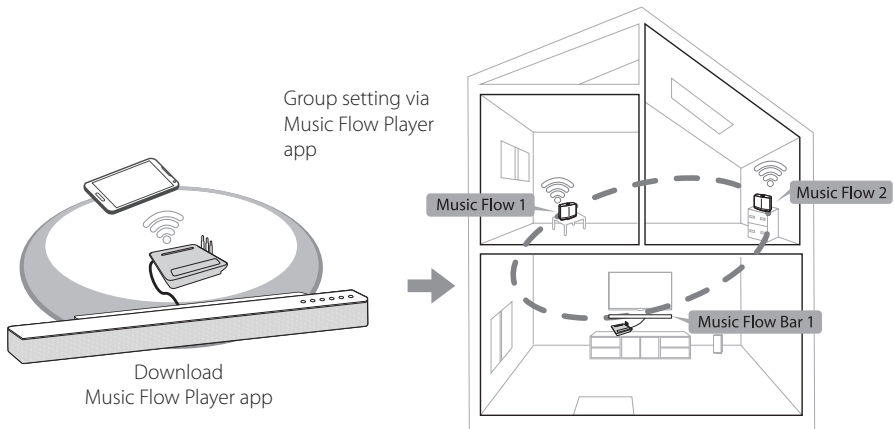

# Installing “Music Flow Player” App

## Through “iTunes store” or “Google Play Store”

1. Tap the “iTunes store” icon or “Google Play Store” icon.
2. Type in “Music Flow Player” in the search bar and tap “Search”.
3. Select “Music Flow Player” in the search result list to download.

### ! Note

- Music Flow Player app will be available in version of the software as follow;  
Android OS : Ver 2.3.3 (or later)  
iOS O/S : Ver 5.1.1 (or later)
- Depending on the device, “Music Flow Player” app may not work.

## Through QR code

Install “Music Flow Player” app through QR code.  
Scan the QR code using the scanning application.

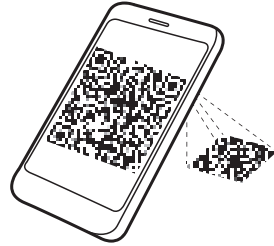

(Android OS)



(Apple iOS)

### ! Note

- Make sure that your smart device is connected to the internet.
- Make sure that your smart device has a scanning application. If you don't have, download it from “iTunes store” or “Google Play Store”.

## Starting with Music Flow Player app

1. When you launch Music Flow Player app for the first time, the terms of use appears on the screen. Check the contents of terms of use and select [Accept].



2. Select [Start] to install the speaker you've purchased.



Refer to "Connecting the speaker to your Home Network" on page 25.

### ! Note

If you want to return to the terms of use screen, initialize the Music Flow Player app on the smart device's setting menu.



## Connecting the speaker to your Home Network

Using a wired network provides the best performance, because the attached devices connect directly to the network without radio frequency interference.

Please refer to the documentation for your network device for further instructions.

### Preparation

- Make sure that wireless network environment using a router is installed at your home.
- Make sure that the speaker and the smart device are connected to the same router.

### Requirements



- Wireless router
- Smart device (Android or iOS)

### ! Note

- Make sure that DHCP's server is activated on wireless router.
- If you cannot connect the speaker with your router, go to setting of the router and then make sure that "Allow wireless client to see each other and access my local network" box is unchecked.

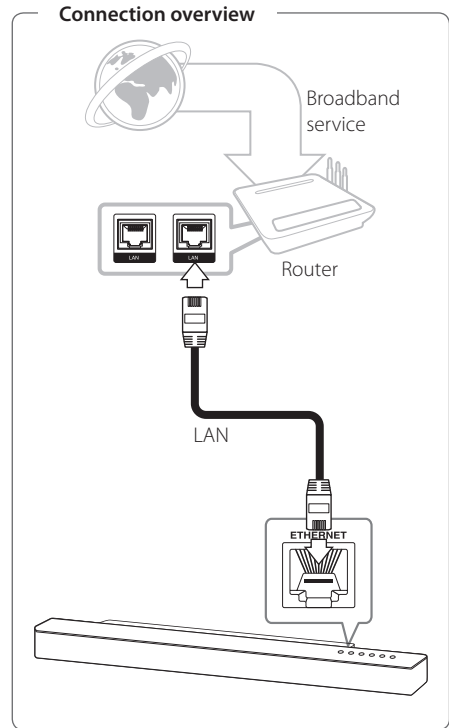
## Connecting the speaker to your network with a LAN cable



1. Turn on the unit by using  on the remote control or  on the unit. The LED indicator starts to blink in white.
2. On your smart device, launch Music Flow Player app. Select [Start] to install the speaker.



3. Check the LED indicator on the unit and select [Next] to go to the next step.



4. Select [Wired connection] on the screen.



5. Connect one end of the LAN cable to the speaker's ETHERNET port and connect the other end to your wireless router. Wait a moment until the LED indicator stops blinking and stays white.

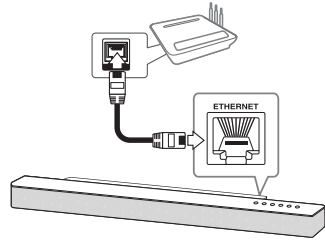

6. Then select [Next] on the screen.



7. Select [Next] to complete the connection.





After connecting the speaker, you can see the list of connected music storage device and music curation screen. Follow the instructions on the screen.

### ! Note

- You cannot use the speaker without a router. When using the wired router, you can control the speaker with Music Flow PC Software. (page 56)
- The speaker and the smart device should be connected to the same router.

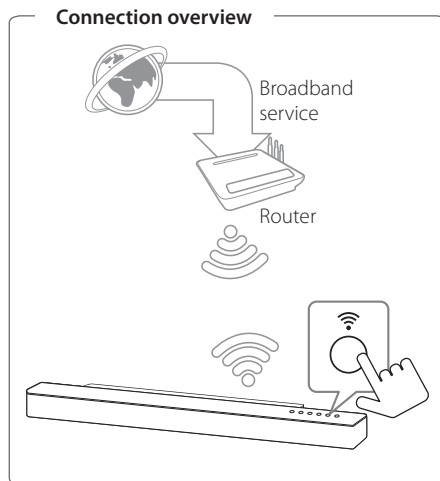
## Connecting the speaker to your Network via the Wi-Fi Setup Method (Android)



1. Turn on the unit by using  on the remote control or  on the unit. The LED indicator starts to blink in white.
2. On your smart device, launch Music Flow Player app. Select [Start] to install the speaker.



3. Check the LED indicator on the unit and select [Next] to go to the next step.



4. Select [Wireless connection] on the screen.



5. Press the  button on the unit. Then the LED indicator blinks in white and red alternately.

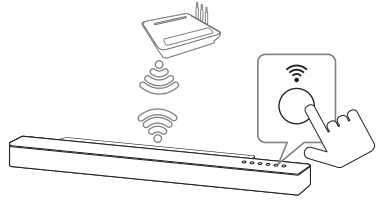

6. Then select [Next] on the screen.



7. If you have a password for your network, the security screen appears on your smart device. Enter your password.



8. Then select [Next] on the screen.



9. Select [Next] to complete the connection.



After connecting the speaker, you can see the list of connected music storage device and music curation screen. Follow the instructions on the screen.

### ! Note

If the speaker fails to connect to your network or its network connection operates abnormally, place the speaker closer to your router and try again.

## Connecting the speaker to your Network via the Wi-Fi Setup Method (iOS)

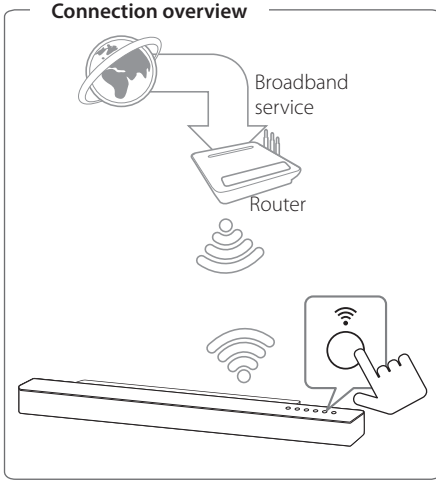

1. Turn on the unit by using on the remote control or on the unit. The LED indicator starts to blink in white.
2. On your smart device, launch Music Flow Player app. Select [Start] to install the speaker.



3. Check the LED indicator on the unit and select [Next] to go to the next step.



4. Select [Wireless connection] on the screen.



5. Press the  button on the unit. Then the LED indicator blinks in white and red alternately.

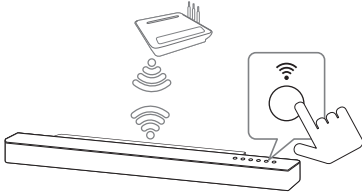

6. Then select [Next] on the screen.



7. On your iOS device, go to iOS setting -> Wi-Fi setting and select "MusicFlow\_Setup" to connect.



**Note**

- If "MusicFlow\_Setup" is not on the list, scan for available Wi-Fi networks again.
- When your smart device is connected to "MusicFlow\_Setup", you cannot use the internet.

8. Once the network connection is completed, return to the Music Flow Player app.



9. If you have a password for your network, the security screen appears on your smart device. Enter your password.



10. On your iOS device, go to iOS setting -> Wi-Fi setting and select wireless router to connect.



11. Once the network connection is completed, return to the Music Flow Player app.



12. Select [Next] to complete the connection.



After connecting the speaker, you can see the list of connected music storage device and music curation screen. Follow the instructions on the screen.

**Note**

If the speaker fails to connect to your network or its network connection operates abnormally, place the speaker closer to your router and try again.



## Notes on Network Connection

- Many network connection problems during set up can often be fixed by re-setting the router. After connecting the speaker to the home network, quickly power off and/or disconnect the power cable of the home network router or cable modem. Then power on and/or connect the power cable again.
  - Our company is not responsible for any malfunction of the speaker and/or the internet connection feature due to communication errors/malfunctions associated with your broadband internet connection or other connected equipment.
  - The wireless network operate at 2.4 GHz radio frequencies that are also used by other household devices such as cordless telephone, Bluetooth® devices, microwave oven, and can be affected by interference from them.
  - Turn off all unused network equipment in your local home network. Some devices may generate network traffic.
  - If the speaker fails to connect to your network or its network connection operates abnormally, place the speaker closer to your router and try again.
  - Depending on your home network environment and the performance of wireless router, it may not work well to connect the speaker to your wireless router.
  - You cannot connect the speaker to wireless router which has hidden SSID.
  - The connection you've made may be disconnected if you select other application or change the setting of the connected speaker via "Music Flow Player" app. In such a case, please check the connection status.
  - Even After connection of Music Flow Player app, music may be output from your smart device. In this case, select the connected speaker on the playback screen.
  - Depending on the speed of your network, playback of online contents may not work well.
  - Wireless signal interference may lead to disconnection of network or stopping playback.
- You need to turn the speaker's power off and on again if you restart the router.
  - You need to perform a factory set and setup the network connection for speaker, if you install new router.

## Connecting the speakers to your Home Network (Additional)

You can enjoy the music with multiple speakers and single smart device you have.

### Requirements

- Wireless router
- Smart device (Android or iOS)
- Another speaker



### Note

Signal interference may lead to stop playback.

## Adding another speaker

### Connection overview

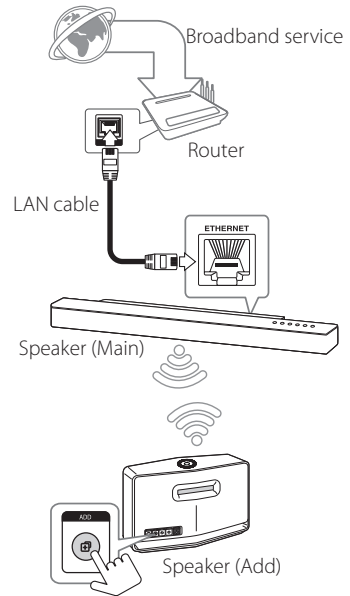

1. Connect the speaker (Main) to your network. Refer to "Connecting the speaker to your home network" on page 25.
2. On your smart device, select the Music Flow Player app. Tap the [Home] menu.



3. Select the [Add Speakers] on the side menu.



**Note**

You can also add another speaker as below.



4. Press the **ADD** button on the rear of the speaker (Add). Then  Network status LED blinks red.

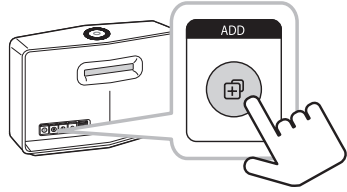

5. Then select the [Next] on the screen.



6. Select [Next] to complete the connection.



**Note**

Speakers may be not connected if the distance between the Sound Bar (Main) connected by LAN cable and the speaker (Add) to be connected is too far.

# Enjoying the Music with Music Flow Player app

With Music Flow Player app, you can play music in your smart device.

## ! Note

- For more detailed instruction about Music Flow Player app, switch on the [User Guide] in [Settings] > [General] on the side menu.
- Some of the content in this part may differ from Music Flow Player app depending on the application's version.

## Preparation

1. Check the network connection with the speaker. (page 25)
2. To use the speaker, you must download and install the Music Flow Player app. (page 23)

## Overview of Home menu

Launch Music Flow Player app on your smart device. The [Home] appears.



- 1 Recommendation** – Click the sentence area to see the recommendation.
- 2 Favorites**– Displays the favorites songs
- 3 Timeline** – Displays the songs played on this speaker.
- 4 Most Played** – Displays the songs most played on this speaker.
- 5 My Playlists** – Displays the playlists.
- 6 How do you feel today?** – Displays the music curation screen.

## ! Note

Depending on your smart device's OS or version of "Music Flow Player" app, some of the content in this manual may differ.

## Overview of the side menu

1. Launch Music Flow Player app on your smart device. The [Home] appears.
2. Tap the [Home] menu.



3. Side menu appears.



- 1 Home** – Displays the Home menu.

---

- 2 My Phone** – Displays the songs on this smart device.

---

- 3 Music Library** – Displays the songs on the connected devices (Media server).

---

- Streaming Services** – Displays the online services. You can enjoy the online radio and music.

---

- 5 Connected Speakers** – Displays the connected speaker.

---

- 6 Add Speakers** – Goes to the speaker installation screen.

---

- 7 Settings** – Displays the settings menu.

## Playing a song

1. Launch Music Flow Player app on your smart device. The [Home] appears.
2. Tap the [Home] menu.



3. Side menu appears.  
Select the [My Phone] on the side menu.

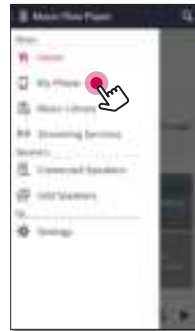

4. Select the desired album.



- Select the desired song. Then selected song is displayed and played.



**Note**

If the speaker is not selected, the selecting speaker pop-up appears. Select a desired speaker.



### Managing a playlist

On an album screen, tap the [⋮] of the desired song. The pull down menu appears.

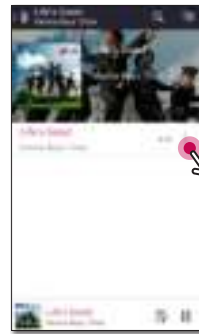

**1 Play next** – Selects music to play next.

**2 Add to queue** – Adds to queue list.

**3 Add to playlist** – Adds to a desired playlist.

**Note**

Depending on your wireless environment, playing a song with the speaker may not work smoothly.

## Overview of Playback

You can confirm and adjust various information on the playback screen.



**1** Displays the speaker that music plays through.

Displays current playing music.

- Repeats the desired contents. Every time you click it, the state changed in the

**2** (Repeat One) - (Repeat All) - (Repeat Off) order.

- Shuffles the music on the list. Music will be played in random order.

Adjusts playback.

**3** - Adjusts the volume.

- Pauses playback.

/ - Skips fast backward or forward.

- Adjusts the sound effect.

Tap the , various option appears.

- Saves the music to the [Favorites]. You can find [Favorites] on [Home] tab

**4** - Adds music to [My Playlist].

- Shares on the social network services.

- Searches for more music that is similar to the music being played.

- Edits the current playlist.

**5** - Selects a speaker to play.

- Displays music menu.

## Selecting Sound effect

This speaker has a number of pre-set surround sound fields. You can select a desired sound mode by tapping .

The displayed items for the equalizer may be different depending on sound sources and effects.

1. During playback, tap the as below.



2. Tap the < or >.



You can select the various sound effects.



Sound Effect	Description
Standard	You can enjoy optimized sound.
Music	You can enjoy comfortable and natural sound.
Cinema	You can enjoy more immersive and cinematic surround sound.
Flat	Provides balanced sound.
Boost	Boosts the mid-range for sound reinforcement.
Treble / Bass	Reinforces the treble and bass.

### ! Note

- When you play the songs with smart device's speaker, the sound equalizer is not supported.
- You can also select a desired sound mode by using **SOUND EFFECT** on the remote control.
- In some of surround modes, some speakers, there's no sound or low sound. It depends on the mode of surround and the source of audio, it is not defective.
- You may need to reset the surround mode, after switching the input, sometimes even after the sound file has been changed.

## Different ways of listening to music

There are a number of differing ways of listening to music : Group, Surround and Seamless playbacks.

### ! Note

If you want to enjoy the group playback and Surround playback, it is recommended that at least one speaker is connected by LAN cable. In the wireless connection, the smoothness of playback is subject to the location of installed speaker. Install the speakers at a short distance from the router. To change speaker connection setting when all the speaker have been already connected wirelessly, reset all the speaker and connect again after connecting the one speaker of them. To enjoy the smooth group playback or surround playback wirelessly, it is recommended to use the router supporting 802.11n. In this case, set the router's security mode setting to OPEN or AES.

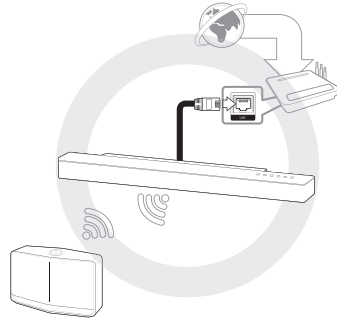

## Group Playback

You can group multiple speakers linked to the Music Flow Player app and play the same music through all the connected speakers in the same group.

1. Select [Connected Speakers] on the side menu of Music Flow Player app.



2. Connected speakers appear. Select the [ ] on the speaker desired song plays through.



3. Grouping option appears. Tap the checkbox to select the speaker you want to play with. Then select [OK].



4. The speakers is ready to group playback.

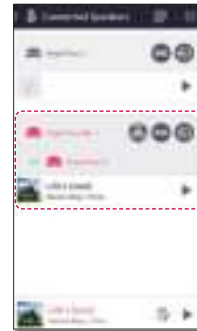

### ! Note

- If the speakers are not grouped, you can enjoy different music on each speaker.
- It is recommended to connect less than 5 devices for the smooth playback.
- Because of a long distance between speakers and the wireless router or signal interference, the signal may become weak. This can cause abnormal playback.
- Depending on your wireless environment, the grouping may be broken.
- For smooth playback, it is recommended to select the speaker connected by LAN cable as a master speaker. If you set the master speaker connected wirelessly, place it closer to a speaker connected wired.

## Surround playback

You can enjoy surround sound by adding another two speakers.

1. Select [Connected Speakers] on the side menu of Music Flow Player app.



2. Connected speakers appear. Select the [Speaker] on the speaker.



3. Surround environment option appears. Select the left and right speakers by tapping connected speakers. Then select [OK].



4. The speakers are ready to surround playback.



### ! Note

- It is recommended to set the surround speakers to same models.
- Because of a long distance between speakers and the wireless router or signal interference, the signal may become weak. This can cause abnormal playback.
- Depending on your wireless environment, the grouping may be broken.
- For smooth playback, it is recommended to select the speaker connected by LAN cable as a master speaker. If you set the master speaker connected wirelessly, place it closer to a speaker connected wired.

## Seamless playback

You can easily change the playing speaker from your smart device or the speaker to the another speaker without pause.

### Note

- It is not supported when you go out of the house with your smart device.
- Wi-Fi function on smart device must be turned on.
- If the source is Portable In and Bluetooth, seamless play is not supported. (Media server and online streaming service are supported).
- In case of the online streaming service, Seamless Play may be unavailable.
- On seamless play, each speaker keeps its existing volume value. If there is no sound coming out from the speaker during playback, check to see if the switched speaker's volume is set to 0.

## Changing playing speaker from a smart device to a speaker

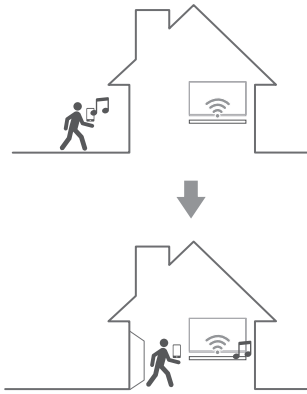

1. If the smart device playing music is carried from outside to a room where the connected speaker is in, the pop-up window on the smart device will appear to ask you which speaker you want to play music through.
2. Select the speaker on the pop-up list, the music you are listening to is played through without a pause.

### Note

- Pop-up window disappears automatically in below cases,
  - When you select the speaker on pop-up list.
  - 10 seconds later after pop-up window appears. (Android Only)
- The latest connection is placed at the top of the list on the pop-up window.

## Using LG HomeChat

### ! Note

- For more information, see <http://homechat.lge.com>.
- Depending on the region, the LG HomeChat service may not be available.

## About LG HomeChat

- What kind of service is LG HomeChat?
  - LG HomeChat service enables users to chat with Smart home appliances in friendly, daily language through mobile messenger LINE.
- What kind of audio functions does LG HomeChat provide?
  - Control : Play, Pause, Mood Station, Volume Settings, Shuffle, Repeat, Alarm/Sleep Timer, etc.
  - Monitoring : Audio Status, View Alarm(s)/Sleep Timer(s)
  - Situation Scenario : Coming home, Sleeping and Party mode

### ! Note

Supported LG HomeChat functions may vary over time.

## How to start LG HomeChat

### Step 1. Install LINE

Please check if "LINE" application is installed on your mobile device, and if not, search and install "LINE" from your application market(Google Play Store, Apple App Store, etc.).

### ! Note

Additional data charges may occur if installed over 3G/4G, according to your device plan.

### Step 2. Adding LG HomeChat as a friend on LINE

1. Launch LINE and tap "More > Official Accounts" button!
2. Find "LG HomeChat" from the list or search for "LG HomeChat" through search function and select it!
3. Add "LG HomeChat" as friend, and you are ready to chat with LG HomeChat.

### Step 3. Agree to Service Terms and Conditions

1. Please tap the Terms and Conditions link in your LG HomeChat conversations.
2. Please confirm your age. (Age requirements may vary for different countries.)
3. Read our terms and conditions, check off the three boxes, and tap the "I Agree" button.

### ! Note

For a safe appliance control, LG HomeChat does not allow service to young children. Please make sure young children do not use LG HomeChat service.

## Step 4. Connect audio to LG HomeChat

1. To control your home appliance(s) through HomeChat, you need to make sure that the smart device installed Music Flow Player and the speaker are connected to the same Wi-Fi network and first register your speaker. Enter "Register" for a link for product registration.  
If you haven't installed Music Flow Player app already, refer to Installing "Music Flow Player" App on page 23.
2. Click the audio button to connect product(s) registered to Music Flow Player to LG HomeChat. (For a pop-up asking for app install on Android's KitKat version, tap "yes")
3. Product(s) with "Available" displayed on the right is available for LG HomeChat service. Select product(s) you wish to connect to LG HomeChat, and tap "next".
4. Connection successfully completed! Tap "Return to LG HomeChat Conversations" and chat with your product(s)!

## Step 5. Use LG HomeChat

1. Call "Audio" to give command(s). Enter "Audio What's on now?" or "Audio Status" to check current status of your audio.
2. Enter "Audio Commands" or "Audio Help" to see the list of audio key functions and command short-keys.

### Note

- If you have any questions during LG HomeChat use, enter "Help" for various user's manuals.
- For questions regarding products, contact LG Electronics Service Center for a faster response.

## Usage Examples

### Audio quick button



### Mood station



Analyzes the songs in Music Library using Gracenote, and organizes them according to Mood.

#### ! Note

The organization may not be correct depending on the audio file.

### Audio Commands list



### Coming home



## Setting the Speaker with Music Flow Player app

With Music Flow Player app, you can set the connected speaker in your smart device.

### Note

- For more detailed instruction about Music Flow Player app, switch on the [User Guide] in [Settings] > [General] on the side menu.
- Some of the content in this part may differ from Music Flow Player app depending on the application's version.

### Preparation

1. Check the network connection with the speaker. (page 25)
2. To use the speaker, you must download and install the Music Flow Player app. (page 23)

### Overview of setting menu

1. Launch Music Flow Player app on your smart device.
2. Select [Settings] on the side menu.

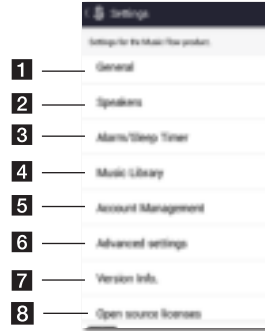

- 
- 1 General** – Sets for easier use of the speaker.

---

  - 2 Speakers** – Sets connected speaker.

---

  - 3 Alarms/Sleep Timer** – Wakes on and off the speaker at a designated time.

---

  - 4 Music Library** – Manages the music Library.

---

  - 5 Account Management** – Manages social networking service and streaming services.

---

  - 6 Advanced settings** – Displays the Advance settings menu. (Page 51)

---

  - 7 Version Info.** – Updates the speaker to the latest version.

---

  - 8 Open source licenses** – Shows LGE Open Source Software Notice.

---



## [General] Menu

Sets for easier use of the speaker.

### Lock Screen Setting (Android only)

This function allows you to display the Music Flow Player on the lock screen. (Lock screen setting is [ON] by default.)

### User Guide

This function allows you to display or delete the guide on the menu.

### Music Curation

Goes to the music curation.

## [Speakers] Menu

You can adjust speakers connected to your network.

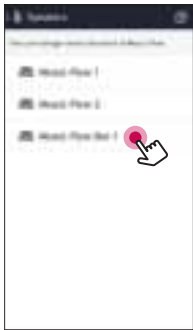

- 1 Rename** – Renames the speaker.
- 2 Speaker LED** – Turns on or off speaker's LED indicator. (LED Indicator is [ON] by default.)
- 3 DRC** – Turns on or off DRC function. (Page 54)
- 4 Night** – Turns on or off Night Mode function. (Page 55)
- 5 Auto Volume On/Off** – Turns on or off Auto Volume function. (Page 56)
- 6 AV Sync** – Adjust the audio and video Synchronization. (Page 54)
- 7 Woofer level** – Adjust Woofer level. (Page 55)
- 8 Auto Display On/Off** – Turns on or off Auto Display function.
- 9 Auto Power On/Off** – Turns on or off Auto Power function. (Page 56)
- 10 Connect to the TV** – Guide you to connect to your TV. (through Optical (page 16) or HDMI (page 17))
- 11 Initialize** – Resets the speaker.
- 12 System version** – Displays the current system version.

## [Alarms/Sleep Timer] Menu

Turns on and off the speaker at a designated time.

### Alarms

Speaker will let you know when it is time.

 Deletes selected alarm.

 Adds new alarm.

### Sleep Timer

Sets a time to automatically turn off the speaker.

1. Select the speaker to set timer on [Sleep Timer] in the [Alarms/Sleep Timer] menu.



2. Set the desired timer on selected speaker.

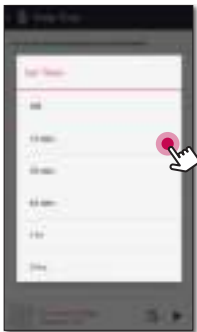

## [Music Library] Menu

Manages the music library.

### Sync Schedule

You can set the time to update the Music index automatically. Select the days and time to perform the update. (Sync Schedule is [OFF] by default.)

#### Note

If you do not select the day, it performs just once at the time you set.

### Sync

Manages the music library.

1. Select the desired server and click the checkbox.



2. Tap the [Update] to update the desired server.

## [Account management] Menu

Manages various social networking service and online streaming service.

#### Note

In case of Music Flow Player app for iOS, social networking service is supported with iOS 6.0 or later.

## [Advanced Settings] Menu

### Mesh Network Channel

If normal playback or group playback is not smooth using multiple speakers including wireless speaker connection, changed the mesh network channel to improve network speed.

1. Select the [Settings] -> [Advanced Settings] option.



2. Select the [ Mesh Network Channel] option. The channel information now being used is displayed.



3. Select the channel to change.
4. The channel information is updated to the selected channel.

#### ! Note

- The speaker is disconnected temporarily during the channel changing.
- If you changed the channel when the speaker turned off, turn on and add it again.
- If the speaker is not connected to network after changing the channel, add the speaker again.

### Auto Music Play

You can easily change the rendering device from your smart device or a speaker to another speaker by approaching your smart device to the desired speaker.

- Your smart device should support Bluetooth Smart.
- This function is subject to the smart device capability and the Wi-Fi network status.
- Auto music play option in the music flow app should be turned on.
- This function may cause more battery consumption.

1. Turn on the [Auto Music Play] option in the Advanced settings menu on the music flow app.



- Place your smart device close enough to the tag on the speaker. It is recommend to be within about 2 inches.
- Set the slide bar at [Close], the leftmost position.
- Move the slide to the right slowly until the notification appears.

#### ! Note

- BLE support specifications in case of android can vary depending on the manufacturer.

Device	O/S
Android	Android 4.3 (or later)
Apple	iOS 7.1 (or later)

### [Account management] Menu

Manages various social networking service and online streaming service.

**Note**

In case of Music Flow Player app for iOS, social networking service is supported with iOS 6.0 or later.

### [Open source licenses] Menu

Shows LGE Open Source Software Notice.



### [Update] Menu

Updates the speaker to the latest version.

#### App version info.

Displays the current application's version.

#### Device version info.

Updates the latest speaker's firmware version.

1. Find the speakers need to update and tap the [ⓘ].



2. Starts the software update.



# Using a Bluetooth Wireless Technology

## About Bluetooth

**Bluetooth®** is wireless communication technology for short range connection.

The sound may be interrupted when the connection interfered by the other electronic wave or you connect the bluetooth in the other rooms.

Connecting individual devices under **Bluetooth®** wireless technology does not incur any charges. A mobile phone with **Bluetooth®** wireless technology can be operated via the Cascade if the connection was made via **Bluetooth®** wireless technology.

Available Devices : Android device, iOS device

## Bluetooth profiles

In order to use Bluetooth wireless technology, devices must be able to interpret certain profiles. This speaker is compatible with following profile.

A2DP (Advanced Audio Distribution Profile)

## Listening to Music of a Bluetooth Device

Before you start the pairing procedure, make sure that the Bluetooth feature on your smart device is turned on. Refer to your Bluetooth device's user guide. Once a pairing operation is performed, it does not need to be performed again.

1. Select the Bluetooth function by using **FUNC** on the remote control or **F** on the unit until the function is selected.  
Appears "BT" and then "BT READY" in display window.
2. Operate the Bluetooth device and perform the pairing operation. When searching for this speaker on your Bluetooth device, a list of the devices found may appear in the Bluetooth device display depending on the type of Bluetooth device. Your speaker appears as "LG HS9 (XX:XX)".
3. Select the "LG HS9 (XX:XX)".

### ! Note

- XX:XX means the last four digits of Bluetooth address. For example, if your unit has a Bluetooth address such as 9C:02:98:4A:BC, you will see "LG HS9 (XX:XX)" on your Bluetooth device.
- Depending on the Bluetooth device type, some device have a different pairing way. Enter the PIN code (0000) as needed.

4. When this unit is successfully connected with your Bluetooth device, "PAIRED" will appear on the display window.
5. Listen to music.

To play music in your Bluetooth device, refer to your Bluetooth device's user guide.

According to your Bluetooth device's volume level, the volume level of Bluetooth will be adjusted.

### ! Note

- When using **Bluetooth®** technology, you have to make a connection between the unit and the bluetooth device as close as possible and keep the distance. However it may not work well in the case below :
  - There is a obstacle between the unit and the bluetooth device.
  - There is a device using same frequency with **Bluetooth®** technology such as a medical equipment, a microwave or a wireless LAN device.
- This unit supports Bluetooth auto pairing. However it does not operate in the case below:
  - When you restart this unit.
  - When you disconnect this unit by yourself.
  - When you disconnect this unit on the connected Bluetooth device.
- The sound may be interrupted when the connection is interfered with by the some other electronic wave.
- You cannot control the Bluetooth device with this unit.
- Pairing is limited to "One" Bluetooth® device. Multi-Pairing is not supported.
- Depending on the type of the device, you may not be able to use the Bluetooth function.
- You can enjoy using Bluetooth® when using Phone, MP3, Notebook, etc..
- The more distance between the unit and the bluetooth device, the lower the sound quality becomes.
- The Bluetooth® connection will be disconnected when the unit is turned off or the Bluetooth® device gets too far from the unit.
- If the Bluetooth® connection is disconnected, connect the Bluetooth® device again.
- When a Bluetooth® device is not connected, "BT READY" appears on the display window.

## Other operations

### DRC (Dynamic Range Control)

Make the sound clear when the volume is turned down (Dolby Digital only). Set to [DRC ON] by using **DRC**.

### AV Sync

When receiving audio signals from TV, sound and images may not be matched. In the case, this function can adjust the delay time.

1. Press **AV SYNC**.
2. Use **◀◀/▶▶** to control the time which you can set at between 0 and 300 ms.

### Turn off the sound temporarily

Press **🔇** (Mute) to mute your unit.

You can mute your unit, for example, to answer the telephone, "MUTE" is displayed in the display window.

To cancel it, press **🔇** (Mute) again on the remote control or change the volume level.

## Displaying input source information

You can display various information of the input source by pressing **INFO**.

OPTICAL/HDMI IN/PORTABLE : Audio format, Audio channel

## Sleep timer setting

This unit will turn off by itself after the time set.

Press **SLEEP** one or more times to select delay time between 10 and 180 minutes.

To check the remaining time, press **SLEEP**.

To cancel the sleep function, press **SLEEP** repeatedly until "SLEEP 10" appears, and then press **SLEEP** once again while "SLEEP 10" is displayed.

### ! Note

You can check the remaining time before the unit turns off. Press **SLEEP** the remaining time appears in the display window.

## Auto power down

This unit will turn itself off to save electric consumption when the main unit is not connected to an external device and is not used for 20 minutes.

It will also turn off after six hours if the Main unit is connected to a device using portable input.

## Using your TV remote control

You can control some functions of this unit by your TV remote control even by other company's product.

Controllable functions are volume up/down and mute.

Press and hold **INFO** on the remote control for about 3 seconds. "ON - TV REMOTE" appears and you can control this unit by your TV remote control.

To check the status of this function, press and hold **INFO**.

To turn off this function, press and hold **INFO** and press it once again while "ON - TV REMOTE" is scrolled.

### ! Note

- Supported TV brands

LG	Panasonic	Philips	Samsung
Sharp	Sony	Toshiba	Vizio

- Make sure that the sound output of your TV is set to [External speaker].
- Depending on the remote control, this function may not work well.
- This function may not work well when some TV control functions such as HDMI CEC, SIMPLINK and LG Sound Sync set to ON.

## Adjust the Treble/Bass/Subwoofer

You can adjust the sound level of Treble, Bass and Subwoofer as your preference.

TREBLE/BASS : -5 dB to 5 dB

SUBWF (Subwoofer) : -20 dB to 6 dB

- Press **⏮** button repeatedly to select TREBLE, BASS or SUBWF (Subwoofer).
- Press **VOL +/—** to adjust the sound level.

## Night mode

Set Night mode to On to reduce the sound intensity and improve fineness and softness.

Press **🌙** button on the remote control. So you can activate Night mode. To cancel it, press **🌙** button again.

## AUTO POWER On/Off

This unit automatically turns on and off by an input source : Optical.

When you turn on your TV or an external device connected to this unit, this unit recognizes the input signal and selects the optical function. You can hear the sound from your device.

This function turns on or off each time you press **AUTO POWER**.

### ! Note

- After the unit is turned on by AUTO POWER function, it will be automatically turned off if there is no signal for a certain period of time from the TV connected by LG Sound Sync (Optical).
- After the unit is turned on by AUTO POWER function, it will be automatically turned off if there is no signal for a certain period of time from the external device.
- If you turned off the unit directly, it cannot be turned on automatically by AUTO POWER function. However the unit can be turned on by AUTO POWER function when optical signal comes in after 5 seconds of no signal.
- Depending on the connected device, this function may not operate.
- If you want to use AUTO POWER, SIMPLINK must be turned off. It takes for about 30 seconds to switch on or off SIMPLINK.

## Sound adjustment

### Adjust volume level automatically

This unit supports Auto volume function that automatically adjusts the volume level.

When the output sound is too loud or too low, press **AUTO VOL** on the remote control. So you can enjoy the sound with appropriate levels.

To cancel this function, press the button again while "ON" is displayed.

## Using Media Server for PC

Media server Software allows users to access audio files stored in media server and enjoy them on this speaker via home networking.

Before connecting to PC to play a file, Media server Software should be installed on your PC.

### ! Note

Make sure that wireless network environment using a router is installed at your home.

- **Windows : Music Flow PC Software**
- **Mac OS : Nero MediaHome 4 Essentials**

## Music Flow PC Software for windows

### About Music Flow PC Software

Music Flow PC Software makes you enjoy the audio files stored on your media server (PC) via the speaker.

### Downloading Music Flow PC Software

1. Start up your computer, visit <http://www.lg.com>. If necessary, select your region.
2. Click support tab.
3. Fill your model name on the cover of owner's manual in search bar.
4. Find and download the "Music Flow PC Software" file.

### Installing Music Flow PC Software

1. Before installation, close all running programs including firewall and Anti-Virus programs.
2. Unzip and double-click "Setup.exe" to install Music Flow PC Software. The installation is prepared and the installation wizard appears.
3. Follow the directions of the installation wizard displayed on the screen.
4. Click the [Exit] button to complete the installation.



**Note**

- Music Flow PC Software is not supported with Mac OS. In case of Mac OS, you can use the Nero MediaHome.
- The Music Flow PC Software is a customized software edition only for sharing files and folders to this speaker.
- If you want a full explanation about Music Flow PC Software, click the question marked icon on home menu.

**System requirements (Windows PC)**

- CPU : Intel® 2.0 GHz or AMD Sempron™ 2000+ processors
- Memory : 1 GB of free RAM
- Graphics card : 64 MB video memory, minimum resolution of 1024 x 768 pixels, and 16 bit color settings
- Free Disk Space : 200 MB
- Windows® XP (Service Pack 2 or higher), Windows Vista®, Windows® 7, Windows® 8.0, Windows® 8.1
- Windows® Media Player® 11.0 or higher
- Network environment: 100 MB Ethernet, WLAN

**Sharing music files**

On your computer, you must share the folder contained music files to play them on this speaker. This part explains the procedure for selecting the shared folders on your computer.

1. Double-click the "Music Flow PC Software" icon.
2. Click [✖] icon in the upper-right-hand corner of the screen. The setting menu appears.
3. On the setting menu, click [☰] icon on the left to go to the sharing file menu.
4. On the sharing file menu, Click [📁+] icon to open the [Browse Folder] window.
5. Select the folder containing the files you want to share. The selected folder is added to the list of shared folders.

**Nero MediaHome 4 Essentials for Mac OS****About Nero MediaHome Essentials**

Nero MediaHome 4 Essentials is a software for sharing video, audio and photo files stored on your computer to this speaker as a digital media server.

**Downloading Nero MediaHome Essentials**

1. Start up your computer, visit <http://www.lg.com>. If necessary, select your region.
2. Click support tab.
3. Fill your model name on the cover of owner's manual in search bar.
4. Find and download the "Nero MediaHome 4 Essentials" file.

**Note**

The Nero MediaHome Essentials software (for Mac OS) can be also downloaded at

- <http://www.nero.com/download.php?id=nmhlgemac>

**Installing Nero MediaHome Essentials**

1. Before installation, close all running programs including firewall and Anti-Virus programs.
2. Unzip and double-click "Setup.exe" to install Nero MediaHome Essentials. The installation is prepared and the installation wizard appears.
3. Follow the directions of the installation wizard displayed on the screen.
4. Click the [Exit] button to complete the installation.

## System requirements (Macintosh)

- Mac OS X 10.5 (Leopard) or 10.6 (Snow Leopard)
- Macintosh computer with an Intel x86 processor
- Hard drive space: 200 MB hard drive space for a typical installation of Nero MediaHome standalone
- Memory: 256 MB RAM

## Sharing music files

On your computer, you must share the folder contained music files to play them on this speaker.

This parts explains the procedure for selecting the shared folders on your computer.

1. Double-click the “Nero MediaHome 4 Essentials” icon.
2. Click [Network] icon on the left and define your network name in the [Network name] field. The Network name you enter will be recognized by your player.
3. Click [Shares] icon on the left.
4. Click [Local Folders] tab on the [Shares] screen.
5. Click [Add] icon to open the [Browse Folder] window.
6. Select the folder containing the files you want to share. The selected folder is added to the list of shared folders.
7. Click [Start Server] icon to start the server.

### ! Note

- The Nero MediaHome Essentials is a customized software edition only for sharing files and folders to this speaker
- If the shared folders or files are not displayed on the player, click the folder on the [Local Folders] tab and click [Rescan Folder] at the [More] button.
- Visit [www.nero.com](http://www.nero.com) for more information and software tools.

## Standby mode



The speaker switches to the standby mode if there is no music playback or no button operation.

### Standby mode

#### Option 1.

If network is disconnected and there is no music playback and no button operation for 20 minutes, the speaker switches to the standby mode. Then “GOOD BYE” appears on the display window and the LED indicator on the unit turns red.

#### Option 2.



If you press and hold /I on the unit or  on the remote control for about 3 seconds, the speaker switches to the standby mode. Then “GOOD BYE” appears on the display window and the LED indicator on the unit turns red.

### Network standby mode

#### Option 1.

When network is connected but music is not played and buttons are not pressed for 20 minutes, the speaker switches to the network standby mode. Then the LED indicator on the unit becomes dimmed in white.

#### Option 2.

If you press /I on the unit or  on the remote control, the speaker switches to the network standby mode. Then the LED indicator on the unit becomes dimmed in white.



### ! Note

On the Network Standby Mode, if you press /I button, the latest music playlist will be played.

## Reset the Speaker

If the speaker is not turned on or doesn't respond, reset the speaker.

### Resetting the speaker

- Press and hold the  button until you hear the beep sound once. You can see "DISABLE" on the display window. Then all wireless network ports are deactivated and the stored wireless network information is deleted.
- Press and hold the  button until you hear the beep sound twice. You can see "RESET" on the display window. You can reset the speaker to its original factory settings.

# Troubleshooting

## General

Symptoms	Cause & Solution
The unit does not work properly.	<ul style="list-style-type: none"> <li>Turn off the power of this unit and the connected external device (TV, Woofer, DVD-player, Amplifier, etc.) and turn it on again.</li> <li>Disconnect the power cord of this unit and the connected external device (TV, Woofer, DVD-player, Amplifier, etc.) and then try connecting again.</li> </ul>
The power does not turn on.	<p>Is the power cord plugged into the outlet?</p> <ul style="list-style-type: none"> <li>Connect the power plug to the outlet.</li> </ul>
A function does not work when the button is pressed.	<p>Is there static electricity in the air?</p> <ul style="list-style-type: none"> <li>Disconnect the power plug and connect it again.</li> </ul>
Sound is not produced.	<p>Is the volume set to minimum?</p> <ul style="list-style-type: none"> <li>Adjust the volume.</li> <li>When you are using connection with a external device (set top box, Bluetooth device etc.), adjust volume level of the device.</li> </ul> <p>Is the mute function activated?</p> <ul style="list-style-type: none"> <li>Press  or adjust the volume level to cancel the mute function.</li> </ul> <p>Is the function selected properly?</p> <ul style="list-style-type: none"> <li>Check the input source and select the correct input source.</li> </ul>
No woofer sound	<p>Is the subwoofer plugged in?</p> <ul style="list-style-type: none"> <li>Plug the power cord of subwoofer into the wall outlet securely.</li> </ul> <p>Is pairing between the unit and the subwoofer disconnected?</p> <ul style="list-style-type: none"> <li>Connect the unit and the subwoofer. (Refer to the page 14.)</li> </ul>
The remote control does not work properly.	<p>Is the remote control too far from the unit?</p> <ul style="list-style-type: none"> <li>Operate the remote control within about 7 m.</li> </ul> <p>Is there an obstacle in the path of the remote control and the unit?</p> <ul style="list-style-type: none"> <li>Remove the obstacle.</li> </ul> <p>Are the batteries in the remote control exhausted?</p> <ul style="list-style-type: none"> <li>Replace the batteries with new one.</li> </ul>
The AUTO POWER function does not work.	<ul style="list-style-type: none"> <li>Check connection of the external device such as TV, DVD/Blu-Ray player or Bluetooth device.</li> <li>Check the state of SIMPLINK and turn off SIMPLINK.</li> <li>Depending on the connected device, this function may not operate.</li> </ul>
LG Sound Sync does not work.	<ul style="list-style-type: none"> <li>Check whether your LG TV supports LG Sound Sync.</li> <li>Check connection of LG Sound Sync.</li> <li>Check sound setting of your TV and this unit.</li> </ul>

Symptoms	Cause & Solution
When you feel the output sound of the unit is low.	<p>Check the details below and adjust the unit according to them.</p> <ul style="list-style-type: none"> <li>• Switch [ON] state of DRC function to [OFF] by using remote controller.</li> <li>• With the sound bar connected with TV, change the AUDIO DIGITAL OUT setting on TV Setup Menu from [PCM] to [AUTO] or [BITSTREAM].</li> <li>• With the sound bar connected with Player, change the AUDIO DIGITAL OUT setting on Player Setup Menu from [PCM] to [PRIMARY PASS-THROUGH] or [BITSTREAM].</li> <li>• Change Audio DRC setting on Player setup menu to [OFF] state.</li> </ul>

## Network

Symptoms	Cause & Solution
Cannot connect the speaker to your home network.	The wireless communication may be interrupted from household devices that are using radio frequencies. Move the speaker away from them.
Media servers are not displayed on the device list.	<ul style="list-style-type: none"> <li>• The firewall or anti-virus software on your media server is running. Turn off the firewall or anti-virus software running on your media server.</li> <li>• Make sure that the speaker is connected to the local area network that your media server is connected.</li> </ul>
I cannot enjoy multiple playback (Group and Surround playbacks).	<p>Is the speaker connected to the network via Wi-Fi?</p> <ul style="list-style-type: none"> <li>• If you want to enjoy the multiple playback, at least one speaker should be connected by LAN cable.</li> <li>• To change network connection using wired connection, if the speakers are connected only wirelessly, disconnect the wireless connections and reconnect them after connecting wired speaker.</li> <li>• When you enjoy the grouping or surround playback, we recommend at least one speaker is connected by LAN cable.</li> </ul>
Music Flow Player doesn't work properly.	<p>Is the Music Flow Player plugged in?</p> <ul style="list-style-type: none"> <li>• Plug in the Music Flow Player.</li> </ul> <p>Is the LAN cable connected to the wireless router and the Music Flow Player properly?</p> <ul style="list-style-type: none"> <li>• Connect the LAN cable to the Ethernet port on the back of the Music FlowPlayer and to your wireless router.</li> </ul> <p>When the Music Flow Player is plugged in, does the Music Flow Player's LED show it's operating properly?</p> <ul style="list-style-type: none"> <li>• If you experience troubles with connecting the Music Flow Player, try relocating the speaker closer to the wireless router or the Music Flow Player.</li> </ul> <p>If you restart the router?</p> <ul style="list-style-type: none"> <li>• You need to turn the speaker's power off and on again.</li> </ul> <p>If you install new router.</p> <ul style="list-style-type: none"> <li>• You need to perform a factory set and setup the network connection for speaker.</li> </ul>

## Application and PC Software

Symptoms	Cause & Solution
Music Flow Player app doesn't work properly.	<p>Does an error occur when accessing the app?</p> <ul style="list-style-type: none"><li>• Make sure that your smart device is compatible with the app.</li><li>• Make sure that the Music Flow Player app is the latest version.</li><li>• Make sure that the speaker's front LED turns from red to white.</li></ul>
Music Flow PC Software doesn't work properly.	<p>Does the firewall on your PC or Mac set to enable?</p> <ul style="list-style-type: none"><li>• Disable all your firewalls and try to connect again. Refer to your firewall's instruction or website.</li></ul> <p>Is the LAN cable connected to the wireless router and your PC or Mac properly?</p> <ul style="list-style-type: none"><li>• Ensure that the speaker and your PC or Mac are correctly connected to the local area network and can access the internet.</li><li>• The wireless communication may be interrupted from household devices that are using radio frequencies. Move the speaker and your PC or Mac away from them.</li></ul>

## File requirement

**Available File extensions:** ".mp3", ".wma", ".flac", ".m4a", ".aac", ".ogg", ".wav"

**Sampling frequency:** within 32 to 48 kHz (mp3, wma), up to 192 kHz/24 bit (flac)

**Bit rate:** up to 320 kbps (mp3, wma)

- The file requirements are not always compatible. There may have some restrictions by file features and media server's ability.
- Some wav files are not supported on this speaker.
- Depending on the types of file or ways of recording, it may not play back.
- Some DRM-loaded files are not supported on this speaker.

## Trademarks and licenses



Manufactured under license from Dolby Laboratories. Dolby and the double-D symbol are trademarks of Dolby Laboratories.



For DTS patents, see <http://patents.dts.com>. Manufactured under license from DTS Licensing Limited. DTS, the Symbol, & DTS and the Symbol together are registered trademarks, and DTS Digital Surround is a trademark of DTS, Inc. © DTS, Inc. All Rights Reserved.



**Bluetooth**® wireless technology is a system which allows radio contact between electronic devices.

Connecting individual devices under **Bluetooth**® wireless technology does not incur any charges. A mobile phone with **Bluetooth**® wireless technology can be operated via the Cascade if the connection was made via **Bluetooth**® wireless technology.

The **Bluetooth**® word mark and logos are owned by the **Bluetooth**® SIG, Inc. and any use of such marks by LG Electronics is under license.

Other trademarks and trade names are those of their respective owners.



The terms HDMI and HDMI High-Definition Multimedia Interface, and the HDMI logo are trademarks or registered trademarks of HDMI Licensing LLC in the United States and other countries.

# Specifications

General (LAS950M (LG HS9))	
Power requirements	200 - 240 V ~ 50 / 60 Hz
Power consumption	50 W
	Networked standby : 6.0 W (If all network ports are activated.)
Dimensions (W x H x D)	(1100 x 106 x 135) mm (without Foot)
Net Weight (Approx.)	8.2 kg
Operating temperature	5 °C to 35 °C
Operating humidity	5 % to 90 %

Input/Output	
OPT. IN	3 V (p-p), Optical jack x 2
PORTABLE IN	0.5 Vrms (3.5 mm stereo jack) x 1
HDMI IN	19 Pin (Type A, HDMI™ connector) x 3
HDMI OUT	19 Pin (Type A, HDMI™ connector) x 1
Available Digital Input Audio Sampling Frequency	32 kHz, 44.1 kHz, 48 kHz, 96 kHz

Amplifier	
Total	700 W
Front	75 W x 2 (4 Ω at 1 kHz)
Rear	75 W x 2 (4 Ω at 1 kHz)
Surround	75 W x 2 (4 Ω at 1 kHz)
Center	75 W (4 Ω at 1 kHz)
Subwoofer	175 W (3 Ω at 80 Hz)
THD	10 %

Wireless subwoofer (S95A1-D)	
Power requirements	Refer to the main label on the subwoofer.
Power consumption	35 W
Type	1 Way 1 Speaker
Impedance	3 Ω
Rated Input Power	175 W
Max. Input Power	350 W
Dimensions (W x H x D)	(296 x 332 x 296) mm
Net Weight (Approx.)	7.6 kg



System	
ETHERNET (LAN) port	Ethernet jack x 1, 10 BASE-T/100 BASE-TX
Wireless LAN (Internal antenna)	Integrated IEEE 802.11n (Draft 2.0) wireless networking access, compatible with 802.11a/b/g/n Wi-Fi networks.

Bluetooth	
Version	4.0
Codec	SBC

- Designs and specifications are subject to change without prior notice.

## Handling the Speaker

### When shipping the speaker

Please save the original shipping carton and packing materials. If you need to ship the speaker, for maximum protection, re-pack the speaker as it was originally packed at the factory.

### Keeping the exterior surfaces clean

- Do not use volatile liquids such as insecticide spray near the speaker.
- Wiping with strong pressure may damage the surface.
- Do not leave rubber or plastic products in contact with the speaker for a long period of time.

### Cleaning the speaker

To clean the player, use a soft, dry cloth. If the surfaces are extremely dirty, use a soft cloth lightly moistened with a mild detergent solution. Do not use strong solvents such as alcohol, benzine, or thinner, as these might damage the surface of the speaker.

## Important Information Relating to Network Services

All information, data, documents, communications, downloads, files, text, images, photographs, graphics, videos, webcasts, publications, tools, resources, software, code, programs, applets, widgets, applications, products and other content ("Content") and all services and offerings ("Services") provided or made available by or through any third party (each a "Service Provider") is the sole responsibility of the Service Provider from whom it originated.

The availability of and access to Content and Services furnished by the Service Provider through the LGE Device are subject to change at any time, without prior notice, including, but not limited to the suspension, removal or cessation of all or any part of the Content or Services.

Should you have any inquiry or problem related to the Content or Services, you may refer to the Service Provider's website for the most up-to-date information. LGE is neither responsible nor liable for customer service related to the Content and Services. Any question or request for service relating to the Content or Services should be made directly to the respective Content and Service Providers.

Please note that LGE is not responsible for any Content or Services provided by the Service Provider or any changes to, removal of, or cessation of such Content or Services and does not warrant or guaranty the availability of or access to such Content or Services.

## TERMS OF USE

These Terms of Use apply to those individuals and groups who use LG's Multiroom Speaker (LG Mutiroom Speaker), any software(s) associated with LG Multiroom Speaker, this application and any services associated this application (collectively "LG Software"). They set out LGE's responsibilities to you as well as identifying the "dos" and "don'ts" that you should be aware of when you use the LG Software. LG Software is proprietary software owned by LG Electronics Inc., a corporation registered in Korea with its registered office at Yeouido-dong 20, Yeoungdeungpo-gu, Seoul, Korea. LGE, and its licensors ("LGE", "us" or "we").

By accessing or using LG Software, you confirm that you accept these Terms of Use and that you agree to comply with them. If you do not agree to these Terms of Use, you may not access or use the LG Software. To the extent that any conflict arises between these Terms of Use and any other document referred to in these Terms of Use, these Terms of Use will take precedence, unless clearly stated otherwise in the relevant document.

We grant you a non-exclusive license to use the pre-installed copy of LG Software solely to the extent necessary for you to use your LG Multiroom Speaker personally and for no other purpose.

You acknowledge that all ownership rights in LG Software anywhere in the world belong exclusively to us and that no ownership rights in LG Software are transferred to you. You are only entitled to the limited use of LG Software as is granted in these license terms.

You may not copy, modify, decompile or reverse engineer our software in any way unless you are allowed to do so by law. We reserve the right to suspend, withdraw or discontinue all or part of the Services without notice if we consider that you are in breach of these Terms of Use.

You acknowledge that LG Software has not been developed to meet your individual requirements. We make no promises or guarantees that LG Software is free from bugs or errors or that it will always be available. We use commercially reasonable efforts to provide LG Software on a continuous, high quality basis but cannot guarantee that they will always be available, uninterrupted or error free. It is possible that we may have to interrupt or discontinue the LG Software or suspend or restrict your use of all

or any part of the Services where we consider it reasonably necessary for technical, operational, security, legal or regulatory reasons.

We do not accept any responsibility if for any reason the Services or any part of them are unavailable at any time or for any period.

Although you may use LG Software to download and access content or applications made available by third parties on your LG Software, we make no promises or guarantees that you will always be able to access such content or applications. So far as we are legally able to do so, we exclude any warranties, conditions or other terms which may be implied into these license terms by law.

So far as we are legally able to do so, we exclude any liability for any loss or damage incurred by you or any other person in connection with your use of LG Software. We are only responsible for loss or damage suffered that is a foreseeable result of our breach of these license terms or our negligence up to the amount specified below, but we are not responsible for any loss or damage that is not foreseeable. Loss or damage is foreseeable if it is an obvious consequence of our breach or if it was contemplated by you and us when you starting using LG Software.

For any loss or damage that is not excluded under these license terms, whether in contract, tort (including negligence) or otherwise, the total liability of us and our group of companies to you is limited to the amount that you paid for your LG Software service. To the extent permissible under the applicable laws, some jurisdictions do not allow the limitation or exclusion of liability for incidental or consequential damages, or have legislation that restricts the limitation or exclusion of liability, so the above limitation may not apply to you.

Nothing in these license terms shall limit or exclude our liability for death or personal injury relating from our negligence, fraud or fraudulent misrepresentation or any other liability that cannot be excluded or limited by law.

LG Software provides access to "apps" and link to other services owned and operated by third parties, such as content providers. Any third party apps, services and content that you access via the Services are made available to you by these third party providers and are outside the scope of these Terms of Use.

Your dealings with any third party providers are solely between you and the relevant provider and

may be subject to the provider's own terms and conditions and privacy policy. We encourage you to read these documents, although we are not responsible for their content. We do not accept any responsibility for apps, services or content provided by third party providers.

We may impose limits on the use of or access to certain third party content, application or services, in any case without notice or liability. We expressly disclaims any responsibility or liability for any change, interruption, disabling, removal of or suspension of any content, application or service made available through this LG Software. We are neither responsible nor liable for customer service related to the content, application and services. Any question or request for service relating to third party's content, application or services should be made directly to the respective content and service providers or application developers, as appropriate. These terms do not affect your statutory rights as a consumer.

Suitability of the Services for children and parental control tools

Modify this accordingly to suit if appropriate: The Services are not directed at children under the age of 13 and are not structured specifically to attract children under 13. Further, certain content that you may access through your use of the Services may contain material that you consider indecent, objectionable or which may not be suitable for children.

If you permit a child to use your LG Smart TV to access the Services, you are solely responsible for deciding whether or not the relevant Services are appropriate for access by that child.

[Your Smart TV offers a parental control tool (by way of a 4 digit PIN). If you have enabled the 4-digit PIN, your LG Smart TV will not be able to display restricted content unless you type in the PIN. You are responsible for setting up and maintaining the parental control tool and any other controls that are available, and we will not be responsible for any harm, loss or damage you suffer or any other user of your LG Smart TV suffers as a result of your failure to do so. Depending on the models of your LG Smart TV, these features may not be available.

Viruses and Security

Modify this accordingly to suit if appropriate: We use commercially reasonable efforts to ensure that the Services are secure and virus free, but those efforts cannot and do not guarantee that the

Services will be free from bugs, viruses, or other vulnerabilities.

Further, we do not accept responsibility for any loss or damage caused by a virus, distributed denial-of-service attack, or other technologically harmful material that may infect your LG Smart TV, data or other material belonging to you, during your use of the Services.

Modify as you think appropriate: Complaints

If you have any queries, concerns or complaints about the Services, please contact [include reference to non-personal LG email address].

Modify as you think appropriate: Miscellaneous

Unless expressly stated otherwise, these Terms of Use and the documents referred to in them contain the entire agreement between us and you relating to your use of the Services and supersede any previous agreements, arrangements, undertakings or proposals, written or oral, between us and you relating to your use of the Services.

We may assign, sub-contract or otherwise transfer any or all of our rights and obligations under these Terms of Use to any company, firm or person. We can only do this if it does not materially affect your rights under these Terms of Use. You may not assign, sub-contract or otherwise transfer your rights or obligations under these Terms to anyone else (except where you dispose of your LG Smart TV to a third party) unless you first agree this with us in writing.

If we decide not to exercise or enforce any right that we have against you at a particular time, then this does not prevent us from later deciding to exercise or enforce that right.

If any part of these Terms of Use is found to be illegal, invalid or otherwise unenforceable by a court or regulator, then, where required, that part shall be deleted and the remaining parts of the Terms of Use will continue to be enforceable.

These Terms of Use do not create or infer any rights that are enforceable by any person who is not party to them.

These Terms of Use are governed by the laws of the country where your LG Smart TV is sold and both you and LGE agree to submit to the exclusive jurisdiction of the courts of the country where your LG Smart TV is sold in connection with the same. This Agreement shall be governed by the laws of the Republic of Korea, excluding their conflicts of laws provisions.

If you have any questions or comments about these Terms of Use please contact [www.lge.com](http://www.lge.com).

These Terms of Use may be updated by LGE from time to time. If we make a material change to our Terms of Use, we will update you via your LG Software or other means.

## OPEN SOURCE SOFTWARE NOTICE

To obtain the source code under GPL, LGPL, MPL and other open source licenses, that is contained in this product, please visit <http://opensource.lge.com>.

In addition to the source code, all referred license terms, warranty disclaimers and copyright notices are available for download.

LG Electronics will also provide open source code to you on CD-ROM for a charge covering the cost of performing such distribution (such as the cost of media, shipping and handling) upon email request to [opensource@lge.com](mailto:opensource@lge.com). This offer is valid for three (3) years from the date on which you purchased the product.

## Gracenote® End User License Agreement

This application or device contains software from Gracenote, Inc. of Emeryville, California ("Gracenote"). The software from Gracenote (the "Gracenote Software") enables this application to perform disc and/or file identification and obtain music-related information, including name, artist, track, and title information ("Gracenote Data") from online servers or embedded databases (collectively, "Gracenote Servers") and to perform other functions. You may use Gracenote Data only by means of the intended End-User functions of this application or device.

You agree that you will use Gracenote Data, the Gracenote Software, and Gracenote Servers for your own personal non-commercial use only. You agree not to assign, copy, transfer or transmit the Gracenote Software or any Gracenote Data to any third party. YOU AGREE NOT TO USE OR EXPLOIT GRACENOTE DATA, THE GRACENOTE SOFTWARE, OR GRACENOTE SERVERS, EXCEPT AS EXPRESSLY PERMITTED HEREIN.

You agree that your non-exclusive license to use the Gracenote Data, the Gracenote Software, and Gracenote Servers will terminate if you violate these restrictions. If your license terminates, you agree to cease any and all use of the Gracenote Data, the Gracenote Software, and Gracenote Servers. Gracenote reserves all rights in Gracenote Data, the Gracenote Software, and the Gracenote Servers, including all ownership rights. Under no circumstances will Gracenote become liable for any payment to you for any information that you provide. You agree that Gracenote, Inc. may enforce its rights under this Agreement against you directly in its own name.

The Gracenote service uses a unique identifier to track queries for statistical purposes. The purpose of a randomly assigned numeric identifier is to allow the Gracenote service to count queries without knowing anything about who you are. For more information, see the web page for the Gracenote Privacy Policy for the Gracenote service.

The Gracenote Software and each item of Gracenote Data are licensed to you "AS IS." Gracenote makes no representations or warranties, express or implied, regarding the accuracy of any Gracenote Data from in the Gracenote Servers. Gracenote reserves the right to delete data from the Gracenote Servers or to change data categories for any cause that Gracenote deems sufficient. No warranty is made that the Gracenote Software or

Gracenote Servers are error-free or that functioning of Gracenote Software or Gracenote Servers will be uninterrupted. Gracenote is not obligated to provide you with new enhanced or additional data types or categories that Gracenote may provide in the future and is free to discontinue its services at any time.

GRACENOTE DISCLAIMS ALL WARRANTIES EXPRESS OR IMPLIED, INCLUDING, BUT NOT LIMITED TO, IMPLIED WARRANTIES OF MERCHANTABILITY, FITNESS FOR A PARTICULAR PURPOSE, TITLE, AND NON-INFRINGEMENT. GRACENOTE DOES NOT WARRANT THE RESULTS THAT WILL BE OBTAINED BY YOUR USE OF THE GRACENOTE SOFTWARE OR ANY GRACENOTE SERVER. IN NO CASE WILL GRACENOTE BE LIABLE FOR ANY CONSEQUENTIAL OR INCIDENTAL DAMAGES OR FOR ANY LOST PROFITS OR LOST REVENUES.

copyright © 2000 to present Gracenote

